

NPTL, PTL series

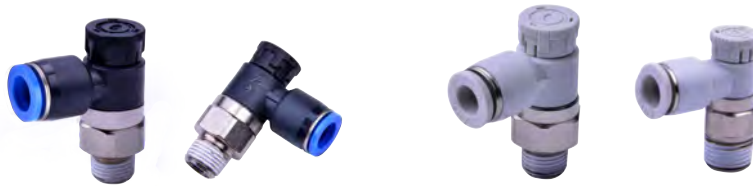

Meter-out (A)



Meter-in (B)



Ordering code

NPTL 1/4 - 1/8 A

① ② ③ ④

① Model

NPTL: Speed controller (Push lock)

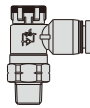

② Port size

5/32: $\Phi 5/32$ "
1/4: $\Phi 1/4$ "
5/16: $\Phi 5/16$ "
3/8: $\Phi 3/8$ "
1/2: $\Phi 1/2$ "

③ Thread connection

Thread	Adaptable port size	
U10: #10-32UNF	$\Phi 5/32$ "	$\Phi 1/4$ "
1/8: NPT1/8	$\Phi 5/32$ "	$\Phi 1/4$ " $\Phi 5/16$ "
1/4: NPT1/4	$\Phi 1/4$ "	$\Phi 5/16$ " $\Phi 3/8$ "
3/8: NPT3/8	$\Phi 1/4$ "	$\Phi 5/16$ " $\Phi 3/8$ "
1/2: NPT1/2	$\Phi 5/16$ "	$\Phi 3/8$ " $\Phi 1/2$ "

④ Control method

A: Meter-out

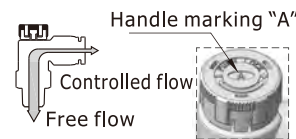

B: Meter-in

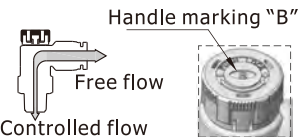

PTL 6 01 A

① ② ③ ④

① Model

PTL: Speed controller (Push lock)

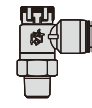

② Port size

6: $\Phi 6$ mm
8: $\Phi 8$ mm
10: $\Phi 10$ mm
12: $\Phi 12$ mm

③ Thread connection

Thread	Adaptable port size
01: PT1/8	$\Phi 6$, $\Phi 8$
02: PT1/4	$\Phi 6$, $\Phi 8$, $\Phi 10$
03: PT3/8	$\Phi 6$, $\Phi 8$, $\Phi 10$, $\Phi 12$
04: PT1/2	$\Phi 8$, $\Phi 10$, $\Phi 12$

④ Control method

A: Meter-out

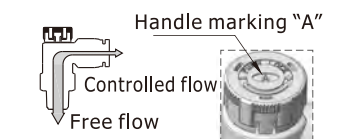

B: Meter-in

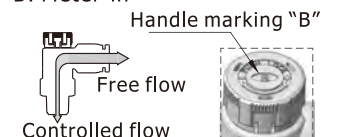

Mini type

PTL 6 M5 A - M

① ② ③ ④ ⑤

① Model

PTL: Speed controller (Push lock)

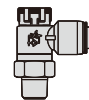

② Port size

4: $\Phi 4$ mm
6: $\Phi 6$ mm

③ Thread connection

M5: M5X0.8
01: PT1/8

④ Control method

A: Meter-out

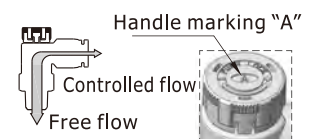

⑤ Style type

M : Mini type

B: Meter-in

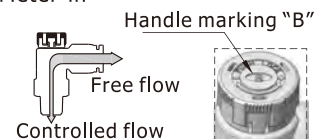

NPTL, PTL series

Table for interface port and tube O.D.

Product series	Thread type	Port size				
		Φ5/32"	Φ1/4"	Φ5/16"	Φ3/8"	Φ1/2"
NPTL	#10-32UNF	•	•			
	NPT1/8	•	•	•		
	NPT1/4		•	•	•	
	NPT3/8		•	•	•	•
	NPT1/2			•	•	•

Product series	Thread type	Port size				
		Φ4	Φ6	Φ8	Φ10	Φ12
PTL	M5	•	•			
	PT1/8	•	•	•		
	PT1/4		•	•	•	
	PT3/8		•	•	•	•
	PT1/2			•	•	•

Specification

Operating pressure range	0~145psi(0~1.0MPa)
Negative pressure	10Torr(-750mmHg)
Proof pressure	215psi(1.5MPa)
Ambient and fluid temperature	-5~160°F(-20~70°C)
Applicable tubing	Soft nylon or polyurethane

Product feature

1. Compare with traditional speed controller, smaller size, lighter weight, suitable for more occasions.
2. Effectively control the action speed and the pressure signal transmission from pneumatic device.
3. Simple push-lock, operation.
4. Adjust quickly, easily and accurately.
5. Excellent flow rate characteristic, high sensitivity and easy to adjust.
6. Options of Meter-out and meter-in, applicable for every type actuator.
7. Effectively prevent from corrosion and pollution by nickle plated brass.
8. The sealant being coated on threaded portion can ensure no leakage of the threaded connection part.

Inner structure

NPTL ,PTL Series

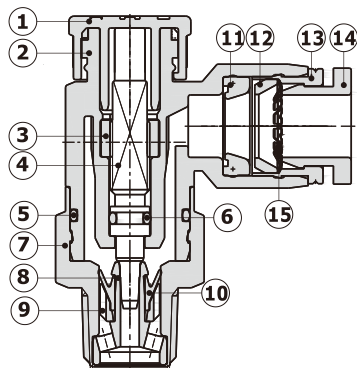

NO.	Name	NO.	Name
1	Adjusting cap	9	Holder
2	Plastic body	10	O-ring
3	Locating ring	11	O-ring
4	Throttling column	12	Locating seat
5	O-ring	13	Locating ring
6	O-ring	14	Plastic interface
7	Throttling body	15	Spring gasket
8	Throttling sleeve		

Selection, Installation and Operation

1. This product rotates in the direction of the finite position mechanism, the rotation torque can not be too large, so as not to cause damage.
The maximum allowable torque is shown right.
2. Push-lock speed controller installation instructions is the same as traditional one. Please refer to traditional type for specific content.

Thread type	Max. allowable torque(N.m)
#10-32UNF/M5	0.05
NPT1/8, PT1/8	0.08
NPT1/4, PT1/4	0.16
NPT3/8, PT3/8	0.24
NPT1/2, PT1/2	0.32

NPTL, PTL series

Dimensions

NPTL Series

[Unit: inch]

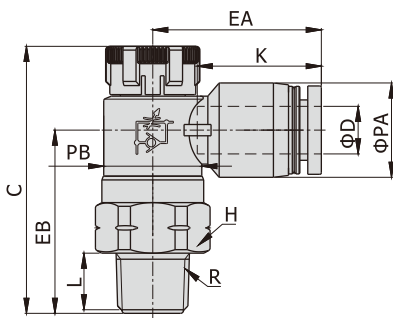

Model\Item [Note1]	ΦD	R	ΦPA	ΦPB	L	C		K	EA	EB	H	Weight (g)
						Pull	Push					
NPTL5/32-U10□	5/32	#10-32UNF	0.33	0.35	0.14	1.14	1.10	0.5	0.65	0.75	3/8	5.6
NPTL5/32-1/8□		NPT1/8	0.33	0.35	0.33	1.14	1.10	0.5	0.65	0.79	7/16	11.8
NPTL1/4-U10□	1/4	#10-32UNF	0.49	0.35	0.14	1.14	1.10	0.65	0.91	0.73	3/8	6.8
NPTL1/4-1/8□		NPT1/8	0.49	0.49	0.33	1.42	1.36	0.65	0.89	0.87	1/2	14.2
NPTL1/4-1/4□		NPT1/4	0.49	0.65	0.43	1.59	1.54	0.65	0.94	1.10	11/16	20.2
NPTL1/4-3/8□		NPT3/8	0.49	0.75	0.46	1.73	1.67	0.65	1.00	1.22	3/4	28.5
NPTL5/16-1/8□	5/16	NPT1/8	0.59	0.51	0.33	1.42	1.36	0.73	0.96	0.89	9/16	13.4
NPTL5/16-1/4□		NPT1/4	0.59	0.65	0.43	1.59	1.54	0.73	1.02	1.06	11/16	21.2
NPTL5/16-3/8□		NPT3/8	0.59	0.75	0.46	1.73	1.67	0.73	1.06	1.18	3/4	29.0
NPTL5/16-1/2□		NPT1/2	0.59	0.94	0.58	2.07	2.01	0.73	1.16	1.48	15/16	48.4
NPTL3/8-1/4□	3/8	NPT1/4	0.71	0.65	0.43	1.59	1.54	0.83	1.22	1.02	11/16	22.7
NPTL3/8-3/8□		NPT3/8	0.71	0.75	0.46	1.73	1.67	0.83	1.14	1.14	3/4	30.5
NPTL3/8-1/2□		NPT1/2	0.71	0.94	0.58	2.07	2.01	0.83	1.24	1.44	15/16	49.9
NPTL1/2-3/8□	1/2	NPT3/8	0.83	0.75	0.46	1.73	1.67	0.89	1.36	1.10	3/4	32.5
NPTL1/2-1/2□		NPT1/2	0.83	0.94	0.58	2.07	2.01	0.89	1.34	1.42	15/16	52.4

[Note1] "□" stands for A or B. A indicates meter-out type while B indicates meter-in type.
The two types are with the same overall dimension.

PTL Series

[Unit: mm]

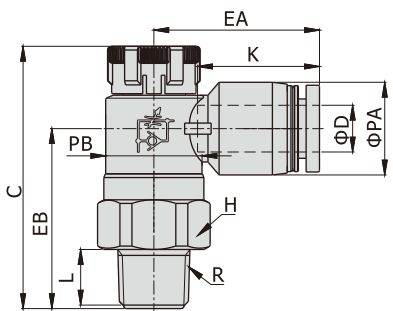

Model\Item [Note1]	ΦD	R	ΦPA	ΦPB	L	C		K	EA	EB	H	Weight (g)
						Pull	Push					
PTL601□	6	PT1/8	12.5	13	8.5	36	34.5	16.5	22.5	23.5	14	12.5
PTL602□		PT1/4	12.5	16.5	11	40.5	39	16.5	24	28	17	19.5
PTL603□		PT3/8	12.5	19	12	44	42.5	16.5	25.5	31	19	28.5
PTL801□	8	PT1/8	15	13	8.5	36	34.5	18.5	24.5	22.5	14	13
PTL802□		PT1/4	15	16.5	11	40.5	39	18.5	26	27	17	20.5
PTL803□		PT3/8	15	19	12	44	42.5	18.5	27	30	19	29
PTL804□		PT1/2	15	24	15	52.5	51	18.5	29.5	37.5	24	49
PTL1002□	10	PT1/4	18	16.5	11	40.5	39	21	31	26	17	22
PTL1003□		PT3/8	18	19	12	44	42.5	21	29	29	19	30.5
PTL1004□		PT1/2	18	24	15	52.5	51	21	31.5	36.5	24	50.5
PTL1203□	12	PT3/8	21	19	12	44	42.5	23	34.5	28	19	32.5
PTL1204□		PT1/2	21	24	15	52.5	51	23	34	36	24	53

[Note1] "□" stands for A or B. A indicates meter-out type while B indicates meter-in type.
The two types are with the same overall dimension.

PTL Mini Series

[Unit: mm]

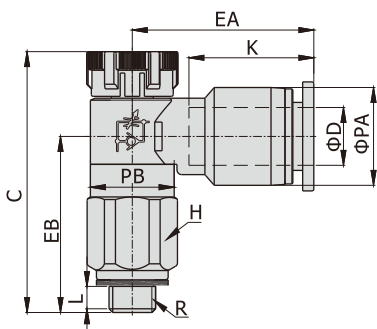

Model\Item [Note1]	ΦD	R	ΦPA	ΦPB	L	C		K	EA	EB	H	Weight (g)
						Pull	Push					
PTL4M5□-M	4	M5×0.8	8.5	9	3.5	29.5	28	12.5	16.5	19	9	5
PTL401□-M		PT1/8	8.5	9	3.5	29.5	28	12.5	16.5	19	10	11
PTL6M5□-M	6	M5×0.8	10.5	9	3.5	29.5	28	13.5	19.5	19	9	6.2
PTL601□-M		PT1/8	10.5	9	3.5	29.5	28	13.5	19.5	19	10	12

[Note1] "□" stands for A or B. A indicates meter-out type while B indicates meter-in type.
The two types are with the same overall dimension.

NPTL, PTL series Flowrate characteristic

Controlled flow rate

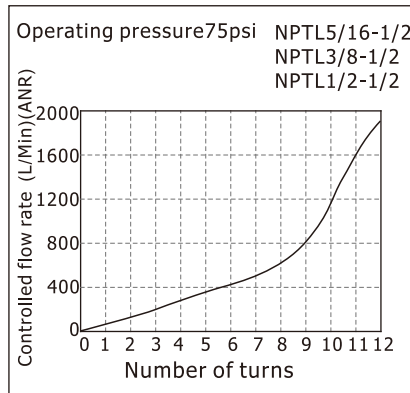
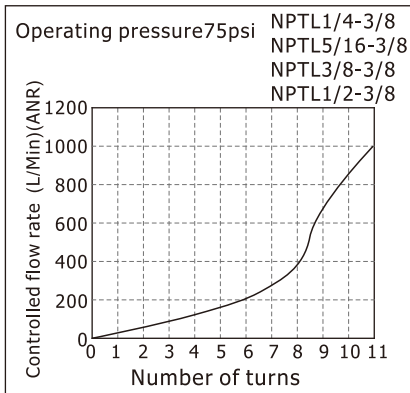
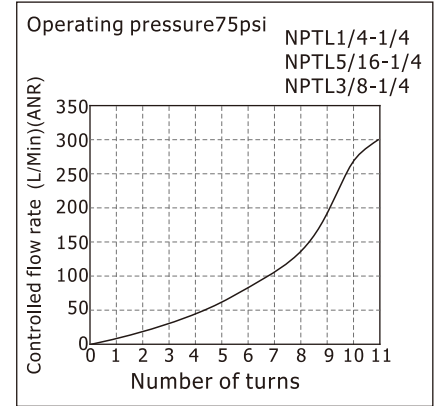
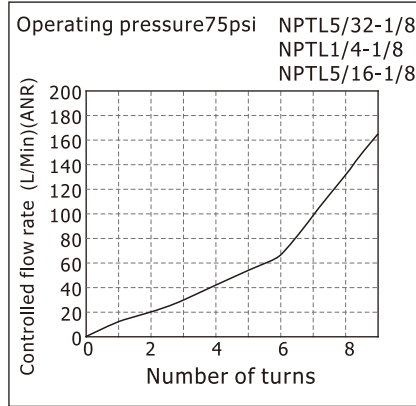
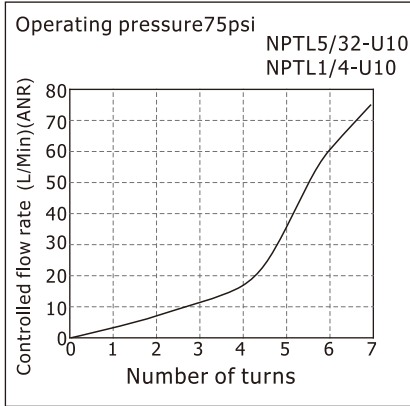

Free flow rate

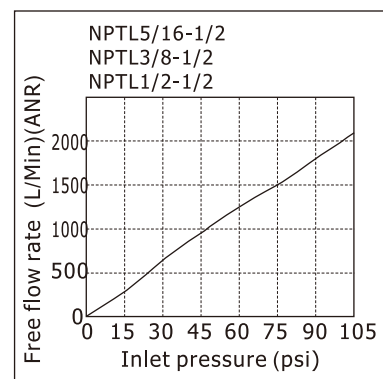
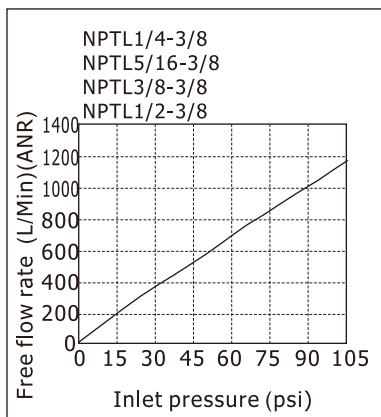
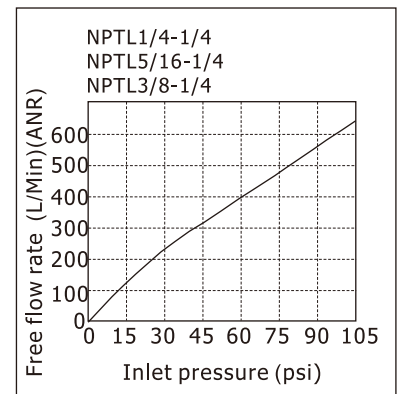
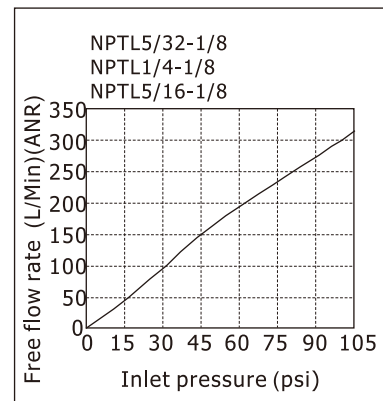
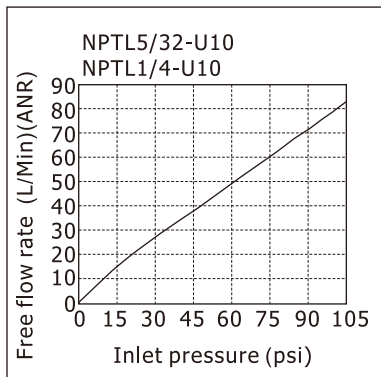

NPTL, PTL series Flowrate characteristic

Controlled flow rate

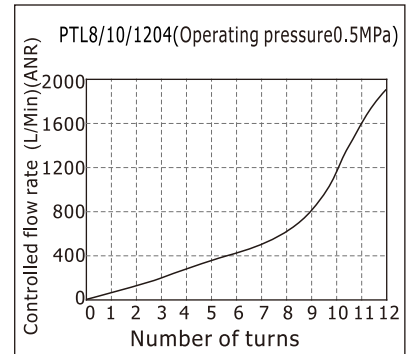
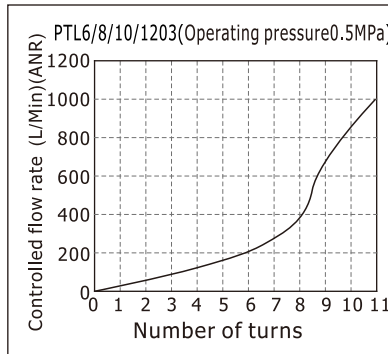
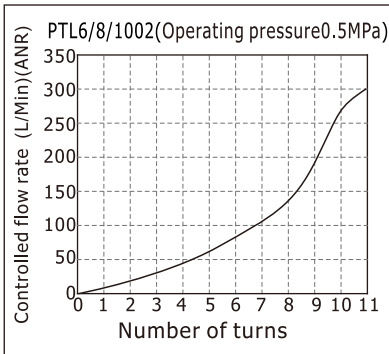
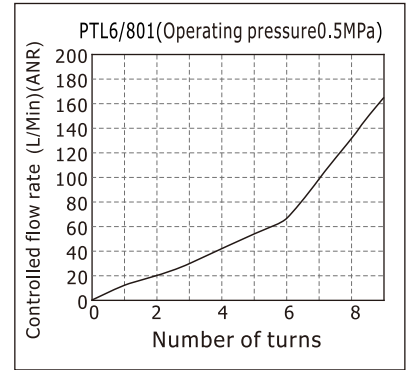
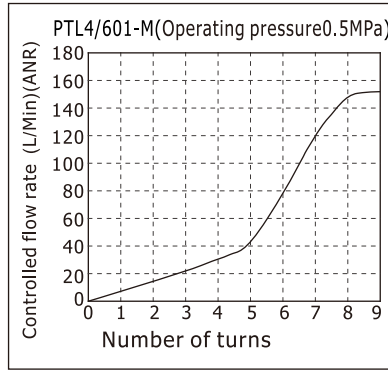
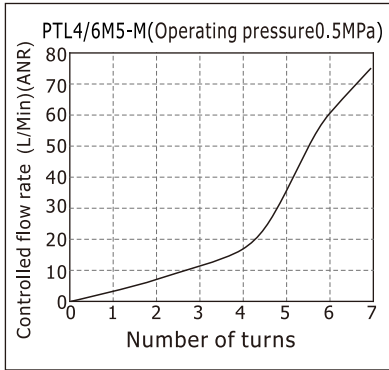

Free flow rate

