

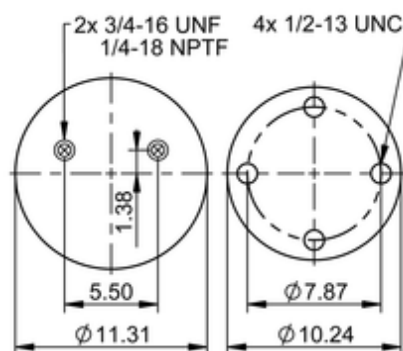

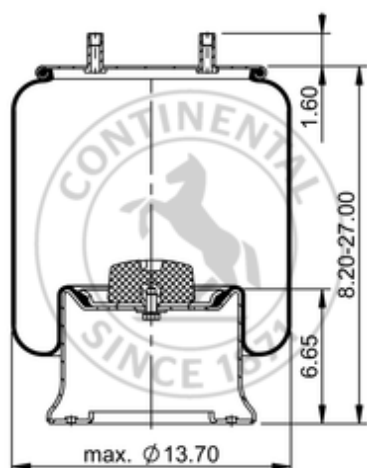



11 10.5-22 S 1199

75465



	26 lb
	9317652
	1/2-13 UNC: max. 35 lbf ft
	1/4-18 NPTF: max. 22 lbf ft
	3/4-16 UNF: max. 50 lbf ft

Cross-reference

Goodyear	1R14-149
Goodyear	1R14-240
Goodyear Flex No.	566283059
Triangle	AS-81199
Automann	1DK28F-S1199

OE Manufacturer/Reference No.

Manufacturer	Original-part no.	Model
Hendrickson	C-24445	