

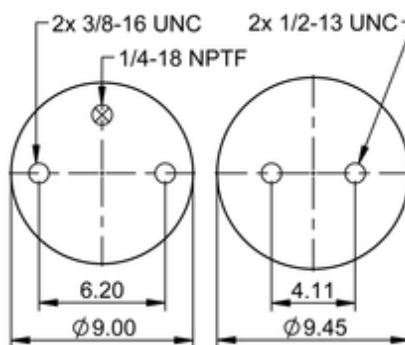

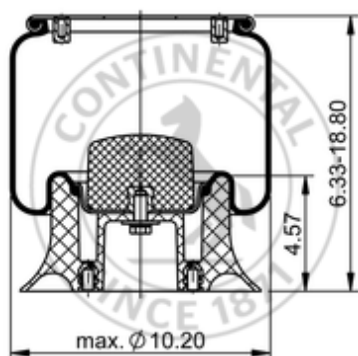



9 9M-13 P 1196

75412



	13.2 lb
	9317208
	1/2-13 UNC: max. 50 lbf ft
	1/4-18 NPTF: max. 22 lbf ft
	3/8-16 UNC: max. 18 lbf ft

Cross-reference

Firestone No.	W01-358-9049
Goodyear	1R10-036

OE Manufacturer/Reference No.

Manufacturer	Original-part no.	Model
--------------	-------------------	-------

