

## FT 76-20 DS CR

## Triple Convolution Air Actuator

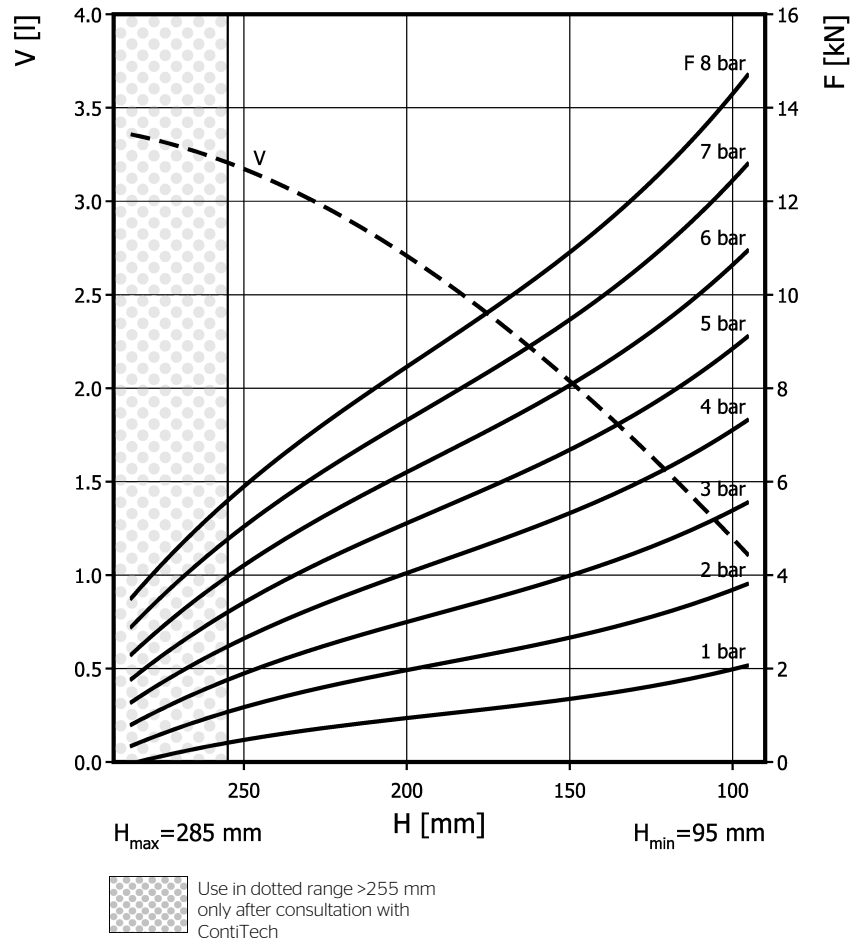
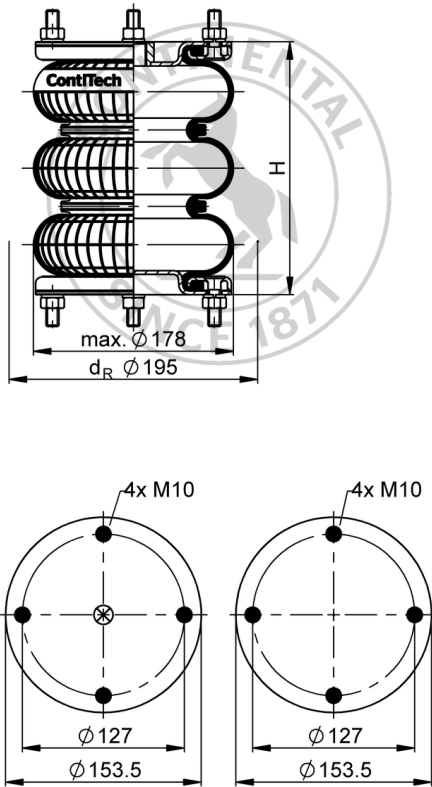

## Purchase order data

Type	Order No.
Rubber bellows only	70204
CR-Rubber bellows, with dismountable plates, G1/2 air inlet	70217

Additional types on request

## Technical data

Min. pressure	0 bar
Return force to min height	≤ 250 N
Overall weight	2.8 kg

## Pneumatic application - static characteristic values

Force F [kN]								
Pressure p [bar]		3	4	5	6	7	8	Vol. V [l]
Height H [mm]	255	1.75	2.46	3.19	3.95	4.74	5.56	3.2
	215	2.69	3.65	4.63	5.64	6.67	7.74	2.9
	175	3.51	4.71	5.93	7.17	8.43	9.71	2.4
	135	4.27	5.69	7.12	8.6	10.1	11.7	1.8



Service instructions  
 M10: max. 25 Nm  
 G1/2: max. 25 Nm

Measuring procedure: Room temperature / Force-height-data quasistatic / Dynamic data at 1 Hz