

SZ 50-11

Sleeve Type Air Actuator

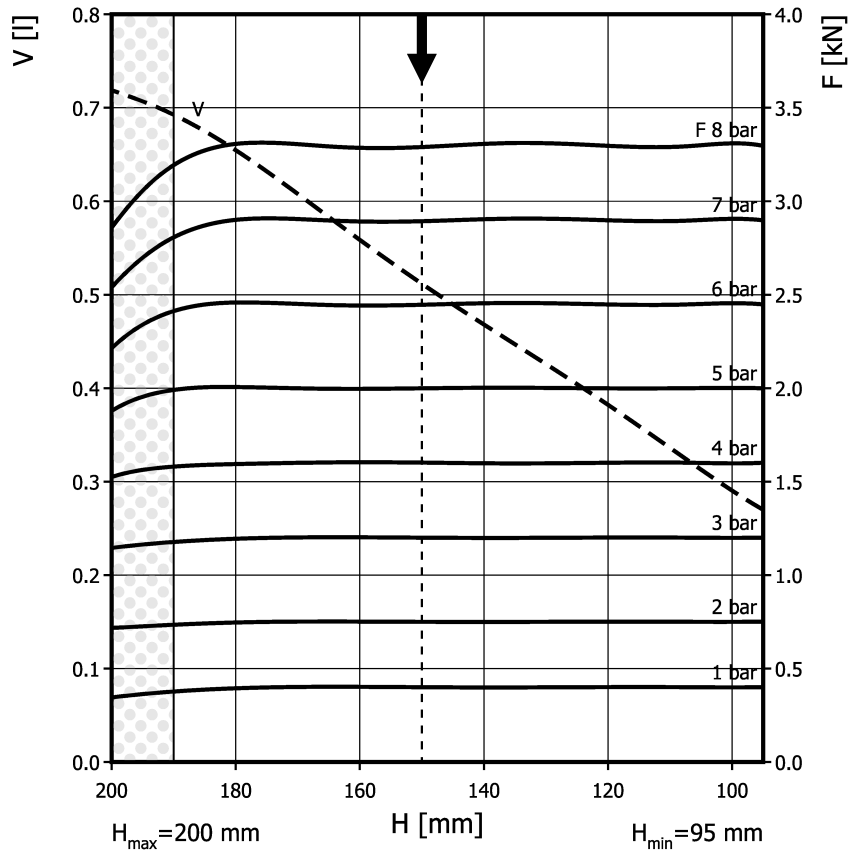
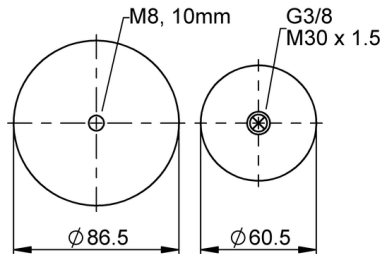
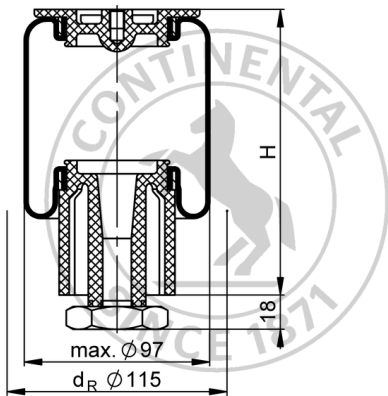

Use in dotted range >190 mm only after consultation with ContiTech

Recommended height for vibration isolation: 150 mm

Purchase order data

Type	Order No.
with plastic connecting parts, G3/8 air inlet A = 0 mm excentrical	2687015000

Additional types on request

Technical data

Min. pressure	0.9 bar
Return force to min height	≤ 450 N
Overall weight	0.5 kg

Vibration isolation - dynamic characteristic values

Design height H: recommended 150mm, guidance in lateral direction required

Pressure p [bar]	3	4	5	6	7	8	Vol. V [l]
Force (Load) [kN]	1.2	1.6	2	2.5	2.9	3.3	
Spring rate [N/mm]	18.5	24	29.5	35	40.5	46	
Natural frequency [Hz]	2.0	1.9	1.9	1.9	1.9	1.9	

Pneumatic application - static characteristic values

Force F [kN]

Pressure p [bar]	3	4	5	6	7	8	Vol. V [l]	
Height H [mm]	190	1.17	1.57	2	2.43	2.82		3.22
	160	1.2	1.6	2	2.45	2.9	3.3	0.56
	130	1.2	1.6	2	2.45	2.9	3.3	0.43
	100	1.2	1.6	2	2.45	2.9	3.3	0.29



Service instructions
M30x1.5: max. 40 Nm
M8: max. 5 Nm
G3/8: max. 10 Nm

Measuring procedure: Room temperature / Force-height-data quasistatic / Dynamic data at 1 Hz