



Lubrication Pumps

Industry Standard in Lubrication Equipment
for Outstanding Performance and Reliability



PROVEN QUALITY. LEADING TECHNOLOGY.

Fire-Ball®: The Industry's Most Trusted Piston Pumps



Unmatched Reliability and Durability

For nearly 50 years, Graco's Fire-Ball pumps have been a mainstay in the lubrication marketplace for durability and long life. Designed for applications requiring continuous duty operation, Graco Fire-Ball pumps repeatedly outperform and outlast the competition.

Install It and Forget About It!

These pumps are built to last. With so many unique maintenance-saving features, Fire-Ball pumps reduce downtime and save you money. Whether you're pumping oil or grease for low, medium or high volume applications, trust Graco's Fire-Ball pumps to get the job done!

Typical Users

- Fast lubes
- Car/truck dealerships
- Municipalities and transits
- Construction equipment and fleet maintenance shops
- Lube trucks
- Manufacturing plants
- General service shops

Typical Fluids

- Lubricating grease
- Motor, synthetic, hydraulic and gear oils
- Automatic transmission fluid
- Undercoating
- Rustproofing
- Sound deadening

Durable

Thick cast aluminum air motor housing offers unmatched durability

Fewer Repairs

Few moving parts in the air motor assembly means less downtime and low repair cost

Reduce Downtime

Displacement rods have minimal wear due to a proprietary Graco manufacturing process

Eliminating Icing

Large air porting design provides efficient use of compressed air supply for continuous pump operation without icing

Corrosion-Resistant

Corrosion-resistant design utilizes liquid salt nitriding, nickel plating, stainless steel, aluminum and chrome on key components for longer life

Extended Seal Life

- In-line pump design aligns the air motor piston and fluid piston rods to maximize seal life
- Throat packings have a u-cup design with a hardened steel displacement rod to minimize wear
- Non-metallic poppet valves offer positive sealing performance, even with contaminated "dirty" air environments for long life without repair

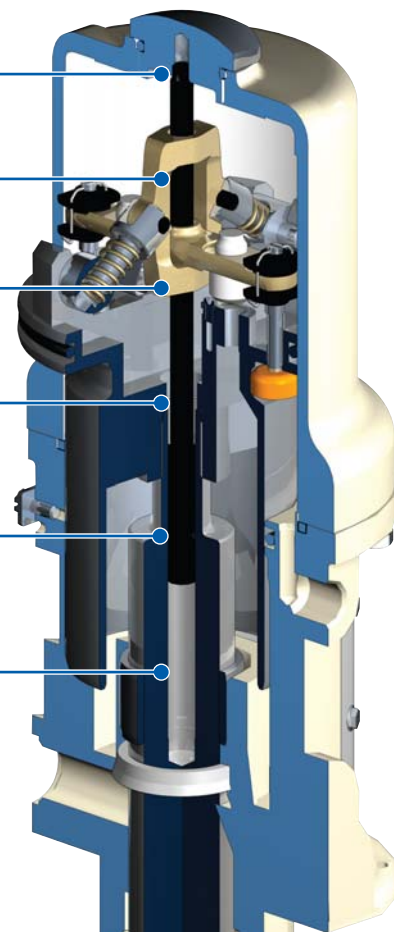

Invest in the Best and Save!



Graco has the total package!

Industry Leading, Worldwide Distribution Network

Our knowledgeable network of distributors provides easy access to professionals who understand your business and recommend the equipment that best fits your application.

Total Customer Support

Leading the industry with “total customer support”, the Graco Lubrication Equipment Division offers you a dedicated Customer Support Team.

Innovative Product Solutions

Graco offers a wide variety of products that support your business, including quality pumps, meters and hose reels.



PUMPS



METERS



REELS

NXT™ Technology

Move Large Amounts of Oil and Grease Fast

Dispenses up to 117 liter (31 gallons) of oil or 26 kg (57 pounds) of grease a minute

- Tested to outperform and outlast all other pumps on the market with its long-life packing design
- Intuitive, easy-to-use controls
- Best value for the money—fewer parts, faster repairs and long-lasting durability

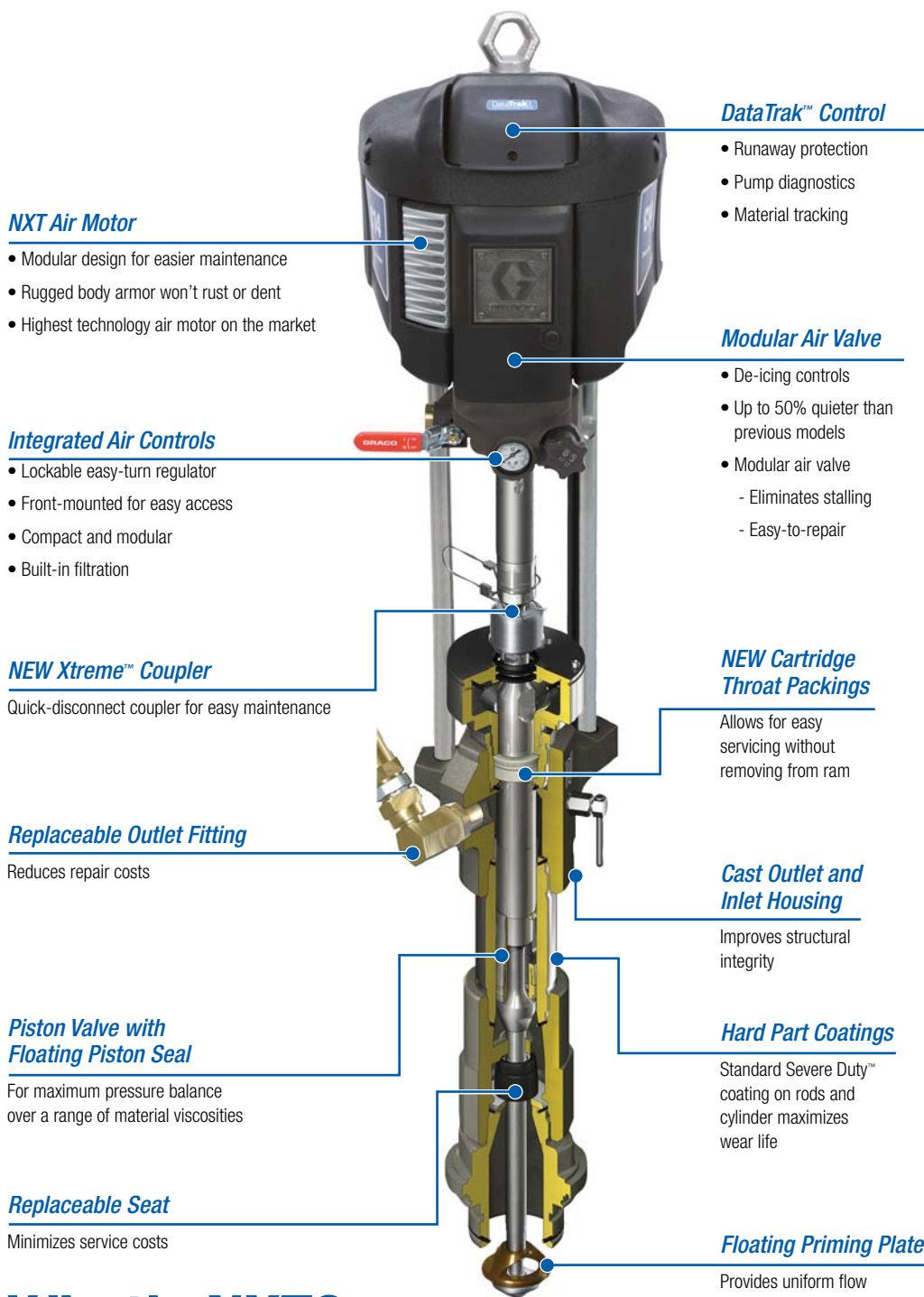

Markets/ Applications

In-Plant

- Supply long-pipe runs or large volume header systems with multiple dispense locations
- Fill remote reservoirs or feed an automated lubrication system
- Transfer and dispense large amounts of lubricant to supply a production process

Mines/Construction

- Rapid fill of lube trucks
- Service off-road equipment needing high volume transfers of oil or transmission fluids
- Feed lubricant to a mine or construction process

Fleets

(municipal, military, aviation)

- Rapid transfer or dispense of lubricants to service fleet equipment
- Supply large volume header systems with multiple dispense locations

What's NXT?

Innovation that boosts your productivity.

Graco NXT. It's what's next.

DataTrak...More Control Than Ever Before



Advanced Graco Control Architecture

The Rules Have Changed

- Provides pump runaway protection by monitoring pump speed. DataTrak automatically shuts the pump off when material runs out or if a hose breaks.
- Tracks and displays material usage and volumetric flow, and tells you how much material is left in the drum. With an accurate, unbiased measurement of flow, DataTrak helps ensure quality control and eliminates material waste.
- Provides pump diagnostics for better maintenance. DataTrak tracks material throughput, which indicates when it's time for routine maintenance. It also provides pump lower diagnostics and lets you know whether the pump is diving in the up or down stroke—a good indication that packings or balls are starting to wear, or the pump needs to be cleaned.

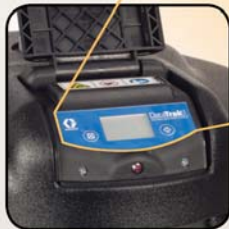
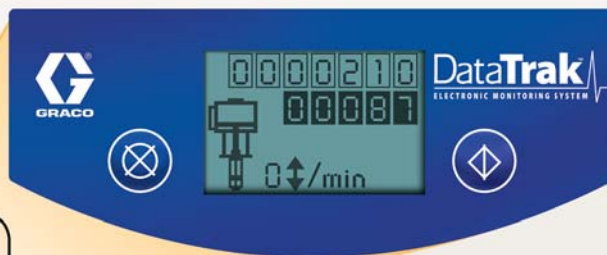

Remote Control for Maximum Convenience

- Integrated ram and pump control is easy to use and easy to see
- Intuitive electronic user interface gives the operator immediate and important operating data at the touch of a button

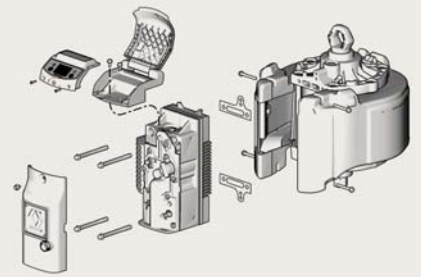

Modular—No Special Tools Required
Graco air motors are designed with modular components so that no special tools are needed for assembly and repair.

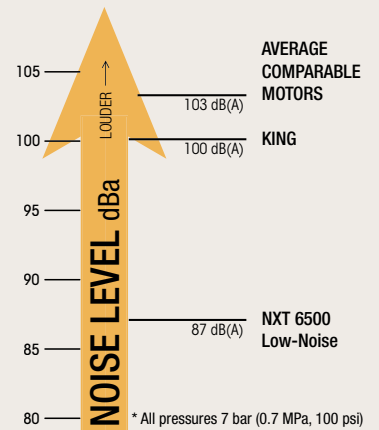

Quiet Operation

The quiet, low-noise NXT Air Motor operates around 87 decibels, while other comparable motors operate up to 103 dB(A).

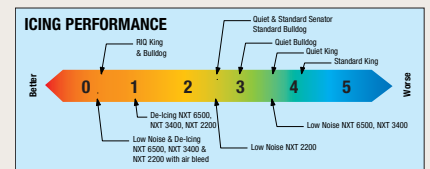

Reduced Icing Keeps You Pumping

Frost or ice can freeze-up the pump when you're moving large volumes of oil or grease. Graco's all new de-icing technology adds warmer ambient air to the air motor to melt any build-up.

Oil Pumps Quick Reference

Manuals: Fast-Ball 307906 Fire-Ball 309869	Cycles per liter (gallon)	Fluid Flow l/min (gal/min) @ 80 cpm	Maximum Fluid Pressure bar (psi)	Air Motor Effective Diameter mm (in)	Air Operating Range bar (psi)	Approx. Air Use and Flow @ 7 bar (100 psi) and 80 cpm	Wetted Materials	Air Inlet Port Size	Fluid Inlet Port Size	Fluid Outlet Port Size
--------------------------------------------------	---------------------------------	----------------------------------------------	-------------------------------------------	-----------------------------------------------	-------------------------------------	----------------------------------------------------------------	---------------------	---------------------------	-----------------------------	------------------------------

Fast-Ball, 1:1*



45.5 (10)	19 (5)	12.5 (180)	35.6 (1.4)	2.7-12.5 (40-180)	5 scfm	CS, Polyurethane	1/4 in npt(f)	1-1/2 in npt(f)	3/4 in npt(f)
-----------	--------	---------------	---------------	----------------------	--------	---------------------	------------------	--------------------	------------------

Line Length‡: Up to 30.5 m (100 ft)
Annual Usage: Up to 19,000 l (5,000 gal)
Dispense Points: 1 (not recommended with hose reel)
Typical Applications: Continuous duty, maintenance facility dispensing motor oil, automatic transmission fluid, hydraulic fluid

Mini Fire-Ball 225, 3:1



11.4 (43.5)	7.0 (1.84)	37 (540)	57.2 (2.25)	2.7-12.5 (40-180)	0.241 m ³ /min @ 7.9 l/min (8.5 scfm @ 2.1 gpm)	Steel, Buna-N, Polyurethane, Aluminum, Rulon®	3/8 in npt(f)	1-1/2 in npt(f)	1/2 in npt(f)
----------------	---------------	-------------	----------------	----------------------	------------------------------------------------------------------	-----------------------------------------------------	------------------	--------------------	------------------

Line Length‡: Up to 76.2 m (250 ft)
Annual Usage: Up to 24,602 l (6,500 gal)
Dispense Points: 1 to 2
Typical Applications: Continuous duty, maintenance facility dispensing motor oil, gear oil, automatic transmission fluid, hydraulic fluid

Fire-Ball 300, 5:1



8.6 (28.4)	9.3 (2.8)	62 (900)	76.2 (3)	2.7-12.5 (40-180)	0.765 m ³ /min @ 11.5 l/min (27 scfm @ 3 gpm)	Steel, Polyurethane, Aluminum, Buna-N	3/8 npt(f)	1-1/2 npt(f)	1/2 npt(f)
---------------	--------------	-------------	-------------	----------------------	----------------------------------------------------------------	---------------------------------------------	------------	--------------	------------

Line Length‡: Up to 152.5 m (500 ft)
Annual Usage: Up to 114,000 l (30,000 gal)
Dispense Points: 1 to 3
Typical Applications: Continuous duty, maintenance facility dispensing motor oil, gear oil, automatic transmission fluid, hydraulic fluid

Fire-Ball 425, 3:1



1.6 (6)	50.6 (13.4)	37 (540)	107.9 (4.25)	2.7-12.5 (40-180)	1.64 m ³ /min @ 50.6 l/min (58 scfm @ 13.4 gpm)	Steel, Polyurethane, Aluminum, Nitrile	1/2 in npt(f)	1-1/2 in npt(f)	3/4 in npt(f)
------------	----------------	-------------	-----------------	----------------------	------------------------------------------------------------------	----------------------------------------------	------------------	--------------------	------------------

Line Length‡: Up to 76.2 m (250 ft)
Annual Usage: Over 114,000 l (30,000 gal)
Dispense Points: 3 to 4
Typical Applications: High flow, low pressure maintenance facility dispensing motor oil, gear oil, automatic transmission fluid, hydraulic fluid

Fire-Ball 425, 6:1



3.2 (12)	6.6 (25.3 liters)	76 (1100)	107.9 (4.25)	2.7-12.5 (40-180)	.334 m ³ /min @ 25.7 l/min (49.5 scfm @ 6.8 gpm)	Steel, Polyurethane, Aluminum, Nitrile	1/2 in npt(f)	1-1/2 in npt(f)	3/4 in npt(f)
-------------	----------------------	--------------	-----------------	----------------------	-------------------------------------------------------------------	----------------------------------------------	------------------	--------------------	------------------

Line Length‡: Up to 152.5 m (500 ft)
Annual Usage: Over 114,000 l (30,000 gal)
Dispense Points: 3 to 4
Typical Applications: High flow, medium pressure, maintenance facility dispensing motor oil, gear oil, automatic transmission fluid, hydraulic fluid

Fire-Ball 425, 10:1



5.2 (19.6)	4.1 (15.4 liters)	124 (1800)	107.9 (4.25)	2.7-12.5 (40-180)	.555 m ³ /min @ 15.4 l/min (32 scfm @ 4.1 gpm)	Steel, Polyurethane, Aluminum, Nitrile	1/2 in npt(f)	1-1/2 in npt(f)	3/4 in npt(f)
---------------	----------------------	---------------	-----------------	----------------------	-----------------------------------------------------------------	----------------------------------------------	------------------	--------------------	------------------

Line Length‡: Up to 228.6 m (750 ft)
Annual Usage: Over 114,000 l (30,000 gal)
Dispense Points: 3 to 4
Typical Applications: Long distance, maintenance facility dispensing motor oil, gear oil, automatic transmission fluid, hydraulic fluid

‡ Consult your local authorized Graco representative for line or pipe sizing

Oil Pumps Quick Reference

See NXT Ordering Information for Instruction Manuals	Output Per Cycle	Output at 60 CPM* l/min. (gpm)	Maximum Fluid Pressure bar (psi)	Motor Size	Maximum Air Input Pressure bar (psi)
------------------------------------------------------	------------------	--------------------------------	----------------------------------	------------	--------------------------------------



Dura-Flo, 6:1

	1000 cc	65.9 (17.4)	42.7 (620)	NXT 3400	6.9 (100)
--	---------	-------------	------------	----------	-----------

Line Length ‡: Up to 152.5 m (500 ft)
Annual Usage: Over 114,000 l (30,000 gal)

Dispense Points: 3 to 4 (simultaneous)
Typical Applications: High pressure, high volume for motor oil, gear oil, automatic transmission fluid and hydraulic fluid

Dura-Flo, 10:1

	1000 cc	65.9 (17.4)	81.3 (1180)	NXT 6500	6.9 (100)
--	---------	-------------	-------------	----------	-----------

Line Length ‡: Up to 228.6 m (750 ft)
Annual Usage: Over 114,000 l (30,000 gal)

Dispense Points: 3 to 4 (simultaneous)
Typical Applications: High pressure, high volume for motor oil, gear oil, automatic transmission fluid and hydraulic fluid

Dura-Flo, 12:1 Carbon Steel or Dura-Flo, 12:1 Stainless Steel

	580 cc	34.8 (9.2)	82.1 (1190)	NXT 3400	6.9 (100)
--	--------	------------	-------------	----------	-----------

Line Length ‡: Up to 304.8 m (1000 ft)
Annual Usage: Over 114,000 l (30,000 gal)

Dispense Points: 2 to 3 (simultaneous)
Typical Applications: High pressure, high volume for motor oil, gear oil, automatic transmission fluid and hydraulic fluid

Dura-Flo, 23:1

	580 cc	34.8 (9.2)	118.9 (1725)	NXT 6500	5.2 (75)
--	--------	------------	--------------	----------	----------

Line Length ‡: Up to 304.8 m (1000 ft)
Annual Usage: Over 114,000 l (30,000 gal)

Dispense Points: 2 to 3
Typical Applications: High pressure, high volume for motor oil, gear oil, automatic transmission fluid and hydraulic fluid



High-Flo, 3.5:1

	2000 cc	119.2 (31.5)	24.1 (350)	NXT 3400	6.9 (100)
--	---------	--------------	------------	----------	-----------

Line Length ‡: Up to 76.2 m (250 ft)
Annual Usage: Over 114,000 l (30,000 gal)

Dispense Points: 4 to 5
Typical Applications: High volume transfer for motor oil, gear oil, automatic transmission fluid and hydraulic fluid

High-Flo, 4.5:1

	1500 cc	87.8 (23.2)	31 (450)	NXT 3400	6.9 (100)
--	---------	-------------	----------	----------	-----------

Line Length ‡: Up to 137.1 m (450 ft)
Annual Usage: Over 114,000 l (30,000 gal)

Dispense Points: 4 to 5
Typical Applications: High volume transfer for motor oil, gear oil, automatic transmission fluid and hydraulic fluid

High-Flo, 6:1

	2000 cc	119.2 (31.5)	34 (500)	NXT 6500	5.2 (75)
--	---------	--------------	----------	----------	----------

Line Length ‡: Up to 152.5 m (500 ft)
Annual Usage: Over 114,000 l (30,000 gal)

Dispense Points: 4 to 5
Typical Applications: High volume transfer for motor oil, gear oil, automatic transmission fluid and hydraulic fluid

*Graco recommends 20 cpm or less for supply applications ‡ Consult your local authorized Graco representative for line or pipe sizing

Oil Pumps

Mini Fire-Ball® 225, Fire-Ball 300 and Fire-Ball 425

Features and Benefits

- Non-corrosive air motor design for long life (metal parts made of stainless steel, aluminum and chrome)
- No metal-to-metal contact means longer pump life and ensures pump will withstand harsh environments
- Double-acting pump provides reliable fluid flow
- Few moving parts translates into low maintenance and low cost of ownership
- Open exhaust port provides continuous operation without icing

Typical Applications

- Medium to low volume and pressure lubricant transfer
- Automotive dealerships
- Heavy-duty dealerships
- Fast lube centers and service shops
- Fleet service facilities
- In-plant
- Lube trucks
- Mining

Typical Fluids Handled

- Petroleum-and synthetic-based oils

Mini Fire-Ball 225, 3:1 Performance Chart

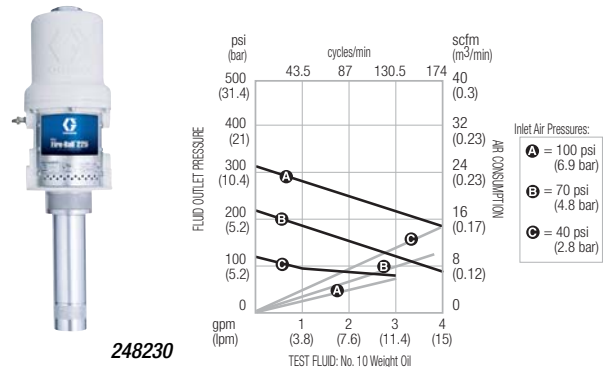

Fire-Ball 300, 5:1 Performance Chart

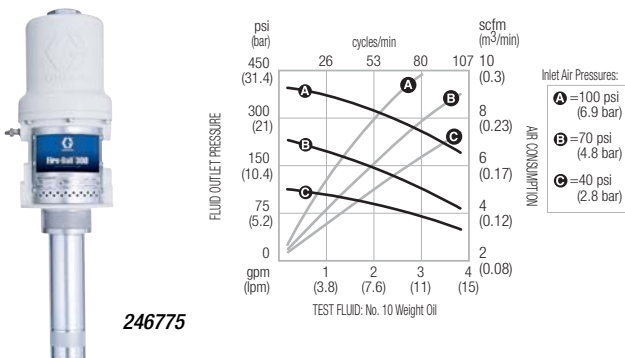

Fire-Ball 425, 3:1 Performance Chart

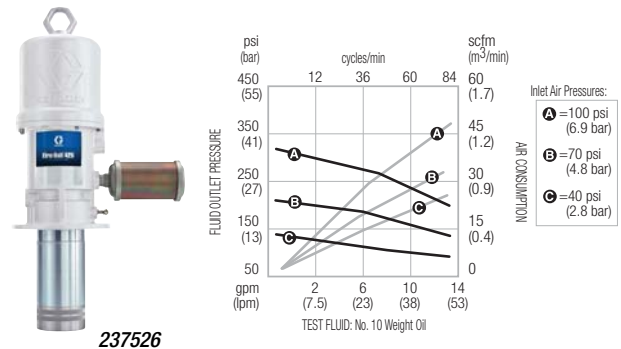

Fire-Ball 425, 6:1 Performance Chart

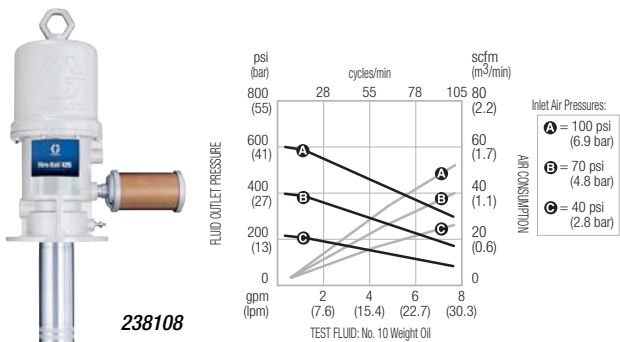

Fire-Ball 425, 10:1 Performance Chart

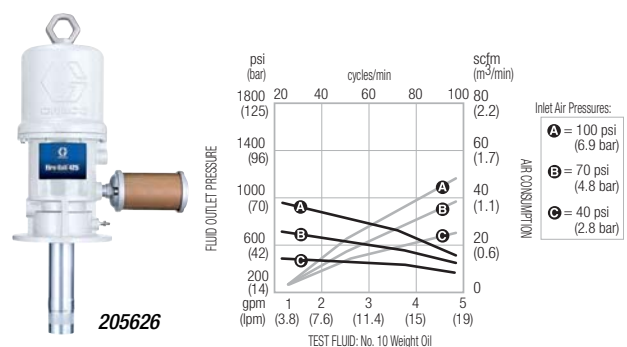

Oil Pumps

Mini Fire-Ball® 225, Fire-Ball 300 and Fire-Ball 425

Mini Fire-Ball 225, 3:1 and Fire-Ball 300, 5:1

Packages	Portable	Cover-Mounted	Cover-Mounted	Bung-Mounted	Bung-Mounted	Universal
Container Size	60 l (16 gal)	60 l (16 gal)	200 l (55 gal)	200 l (55 gal)	1040 l (275 gal)	Universal
225, 3:1 Package	246903‡	246904‡	246906‡	246907*‡	246907*‡	248230*‡
225, 3:1 Pump Only	248097	248097	248097	248097	248097	246775
300, 5:1 Package	225728‡	225094‡	225642‡	225640*‡	225931	225852*‡
300, 5:1 Pump Only	203872	203872	203857	204254	222087	203876
Dispense/Hose Fitting Kit	237075	222063	222063	222063	222063	222062
Fluid Hose	1.8 m x 12.7 mm (6 ft x 1/2 in)	1.8 m x 12.7 mm (6 ft x 1/2 in)	1.8 m x 12.7 mm (6 ft x 1/2 in)	1.8 m x 12.7 mm (6 ft x 1/2 in)	1.8 m x 12.7 mm (6 ft x 1/2 in)	0.5 m x 12.7 mm (1.5 ft x 1/2 in)
Air Hose	—	1.8 m x 9.5 mm (6 ft x 3/8 in)	1.8 m x 9.5 mm (6 ft x 3/8 in)	1.8 m x 9.5 mm (6 ft x 3/8 in)	1.8 m x 9.5 mm (6 ft x 3/8 in)	0.5 m x 9.5 mm (1.5 ft x 3/8 in)
Cover	204574	204574	200326	—	—	—
Air Regulator	224512	224512	224512	—	—	—
Caster Base	203622	—	—	—	—	—
Bung Adapter	—	—	—	222308	222308	—
225, 3:1 Instruction Manual	309868	309868	309868	309868	309868	309868
300, 5:1 Instruction Manual	307884	307883	307883	307883	307883	306520

* Use 9.5 mm (3/8 in) air regulator 109075 as required; must be ordered separately

‡ Order low-level cut-off 203688 separately for metered dispense systems

Fire-Ball 425, 3:1, 6:1 and 10:1

Packages	Cover-Mounted	Bung-Mounted	Universal Supply	Wall Mount
Container Size	200 l (55 gal)	200 l (55 gal)	Universal	Universal†
3:1 Package	—	—	—	244846
3:1 Pump only	—	—	—	237526
6:1 Package	—	—	—	244628
6:1 Pump only	—	—	—	238108
10:1 Package	225782*‡	225786*‡	225853*‡	244847
10:1 Pump Only	222065	222095	205626	205626
Hose/Fitting Kit	222066	222066	222068	222068
Fluid Hose	1.8 m x 19.05 mm (6 ft x 3/4 in)	1.8 m x 19.05 mm (6 ft x 3/4 in)	0.5 m x 19.05 mm (1.5 ft x 3/4 in)	0.5 m x 19.05 mm (1.5 ft x 3/4 in)
Air Hose	1.8 m x 12.7 mm (6 ft x 1/2 in)	1.8 m x 12.7 mm (6 ft x 1/2 in)	0.5 m x 19.05 mm (1.5 ft x 3/4 in)	0.5 m x 12.7 mm (1.5 ft x 1/2 in)
Cover	200326	—	—	—
Filter Regulator	—	—	—	217072
Air Shutoff Valve	—	—	—	110225
Fluid Shutoff Valve	—	—	—	108537
Wall Mount Bracket	—	—	—	238245
Instruction Manual	307883	307883	306520	309351

* Use 12.7 mm (1/2 in) air regulator/gauge 244844 as required; must be ordered separately

‡ Order low-level cut-off 203688 separately for metered dispense systems

† Wall mount universal container for 10:1 only; no container for 3:1, 6:1



Portable
Mini Fire-Ball 225 3:1
(246903) shown

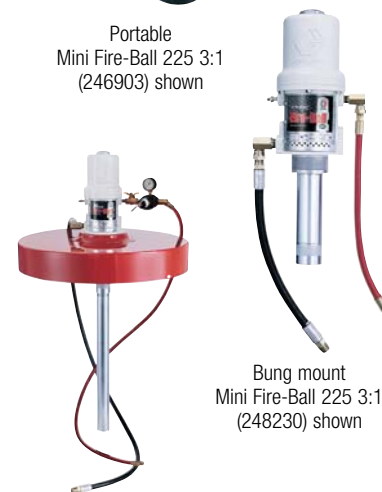

Bung mount
Mini Fire-Ball 225 3:1
(248230) shown

Cover mount
Mini Fire-Ball 225 3:1
(246906) shown

Oil Pumps

NXT™ High-Flo®

Features and Benefits

- Move large amounts of oil fast—dispenses up to 119,2 liter (31.5 gallons) of oil per minute
- Tested to outperform and outlast all other pumps on the market with its long-life packing design
- Models available with intuitive, easy-to-use DataTrak™ controls—gives you pump diagnostics, material usage tracking and pump runaway protection
- Reduces icing and noise—new NXT air motor is up to 50% quieter than previous models

Typical Applications

- In-plant to supply long-pipe runs or large volume header systems with multiple dispense locations
- Fill remote reservoirs or feed an automated lubrication system
- Transfer and dispense large amounts of lubricant to supply a production process
- Mines/construction for rapid refill of lube trucks and to service off-road equipment



Package Number with DataTrak		247888	247889	247892	247893
Package Number without DataTrak		24D602	24D603	24D606	24D607
Pump Specifications	Ratio	3.5:1	4.5:1	6:1	6:1
	Mounting	Wall (255143)	Wall (255143)	Wall (255143)	Stand (218742)
	Pump with DataTrak and thermal relief kit	24D590	24D591	24D594	24D594
	Pump w/o DataTrak and thermal relief kit	24D596	24D597	24D600	24D600
	Output per Cycle	2000cc	1500 cc	2000 cc	2000 cc
	Output at 60 CPM*	119.2 l/min. (31.5 gpm)	87.8 lpm (23.2 gpm)	119.2 l/min. (31.5 gpm)	119.2 l/min. (31.5 gpm)
	Motor Size	NXT 3400	NXT 3400	NXT 6500	NXT 6500
	Maximum Fluid Pressure	24.1 bar (350 psi)	31.0 bar (450 psi)	35.2 bar (500 psi)	35.2 bar (500 psi)
	Maximum Air Input Pressure	6.9 bar (100 psi)	6.9 bar (100 psi)	5.2 bar (75 psi)	5.2 bar (75 psi)
Manuals	System Manual	312862	312862	312862	312862
	Pump Manual	311211	311211	311831	311831
	Pump Lower Manual	311690	311690	311832	311832
	Motor Manual	311238	311238	311238	311238
Inlet/Outlet	Pump Inlet Size	1 1/2 in npt (f)	1 1/2 in npt (f)	2 in npt (f)	2 in npt (f)
	Pump Outlet Size	1 in npt (f)	1 in npt (f)	2 in npt (f)	2 in npt (f)
Hoses	3/4 in x 1.2 m (4 ft) Air Hose	110048	110048	110048	110048
	1 in x 1.8 m (6 ft) Fluid Hose	115042	115042	247969	247969

*Graco recommends 20 CPM or less for supply applications

Performance Charts

Test Fluid is No. 10 Weight Oil for all pumps

A = 7.0 bar (100 psi) air pressure
B = 4.9 bar (70 psi) air pressure
C = 2.8 bar (40 psi) air pressure

A = 7.0 bar (100 psi) air pressure
B = 4.9 bar (70 psi) air pressure
C = 2.8 bar (40 psi) air pressure

A = 4.9 bar (70 psi) air pressure
B = 3.7 bar (55 psi) air pressure
C = 2.8 bar (40 psi) air pressure

3400cc NXT Air Motor, 2000cc High-Flo Lower

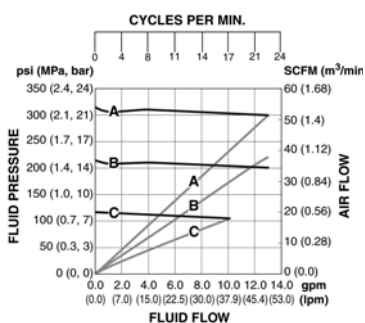

3400cc NXT Air Motor, 1500cc High-Flo Lower

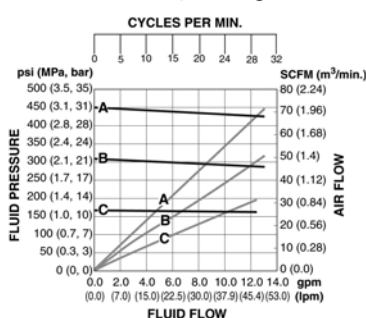

Key

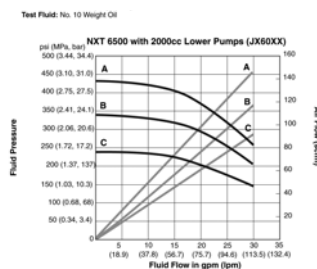

Oil Pumps

NXT™ Dura-Flo®



Performance Charts

A = 7 bar (100 psi) air pressure or 105 bar (1500 psi) hydraulic oil pressure
 B = 4.9 bar (70 psi) air pressure or 75 bar (1050 psi) hydraulic oil pressure
 C = 2.8 bar (40 psi) air pressure or 42 bar (600 psi) hydraulic oil pressure

Test Fluid is No. 10 Weight Oil for all pumps

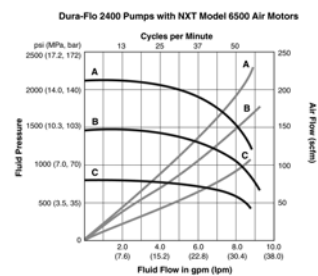
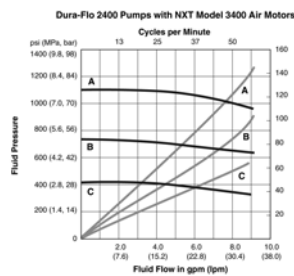
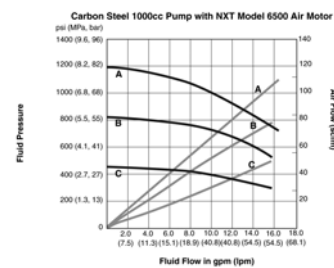
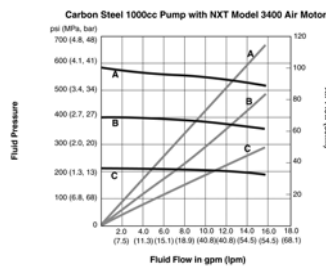

Package Number with DataTrak		247890	247894	247891	247895
Package Number without DataTrak		24D604	24D608	24D605	—
Pump Specifications	Ratio	6:1	10:1	12:1	23:1
	Mounting	Wall (255143)	Wall (255143)	Wall (255143)	Wall (255143)
	Pump with DataTrak and thermal relief kit	24D592	24D595	24D593	—
	Pump w/o DataTrak and thermal relief kit	24D598	24D601	24D599	—
	Output per Cycle	1000cc	1000cc	580cc	580cc
	Output at 60 CPM*	65.9 l/min. (17.4 gpm)	65.9 l/min. (17.4 gpm)	34.8 l/min. (9.2 gpm)	34.8 l/min. (9.2 gpm)
	Motor Size	NXT 3400	NXT 6500	NXT 3400	NXT 6500
	Max. Fluid Pressure	4.3 bar (620 psi)	81.3 bar (1180 psi)	82.1 bar (1190 psi)	118.9 bar (1725 psi)
	Max. Air Input Pressure	6.9 bar (100 psi)	6.9 bar (100 psi)	6.9 bar (100 psi)	5.2 bar (75 psi)
Manuals	System Manual	312862	312862	312862	312862
	Pump Manual	311833	311833	311826	311826
	Pump Lower Manual	311717	311717	311825	311825
	Motor Manual	311238	311238	311238	311238
Inlet/Outlet	Pump Inlet Size	2 in npt(f)	2 in npt(f)	2 in npt(f)	2 in npt(f)
	Pump Outlet Size	1 1/2 in npt(m)	1 1/2 in npt(m)	1 1/2 in npt(m)	1 1/2 in npt(m)
Hoses	3/4 in x 1.2m (4 ft) Air Hose	110048	110048	110048	110048
	1 in x 1.8m (6 ft) Fluid Hose	115042	115042	115042	115042

*Graco recommends 20 CPM or less for supply applications

Grease Pumps Quick Reference

Manual Number	Continuous-Duty Flow Rate kg/min. (lb/min.)	Maximum Fluid Pressure bar (psi)	Air Motor Effective Diameter mm (in)	Operating Range bar (psi)	Approximate Air Use	Wetted Materials	Air Inlet Port Size	Material Inlet	Material Outlet
---------------	---------------------------------------------	----------------------------------	--------------------------------------	---------------------------	---------------------	------------------	---------------------	----------------	-----------------



Mini Fire-Ball 225, 50:1

	.15 (0.32)	578 (8400)	57.2 (2.25)	3-10 (40-140)	0.2 m ³ /min (7.3 scfm) @ .18 kg/min (0.41 lb/min.) @ 7 bar (100 psi) @ 80 cpm	Steel, Urethane, Aluminum, Buna-N, Brass, Ethylene, Delrin®	3/8 in npt(f)	Slotted	1/4 in npt(f)
--	---------------	---------------	----------------	------------------	-------------------------------------------------------------------------------------------------	-------------------------------------------------------------	------------------	---------	------------------

309966

Line Length‡: Up to 30.5 m (100 ft)
Annual Usage: Up to 2,268 kg (5,000 lb)

Dispense Points: 1
Typical Applications: Small maintenance facility



Fire-Ball 300, 50:1

	.54 (1.19)	580 (8400)	76.2 (3)	3.0-9.7 (30-140)	0.645 m ³ /min (22.8 cfm) @ 7 bar (100 psi)	CS, Delrin®, Buna-N, Polyurethane	3/8 in npt(f)	Slotted	1/4 in npt(f)
--	---------------	---------------	-------------	---------------------	-----------------------------------------------------------	-----------------------------------	------------------	---------	------------------

308883

Line Length‡: Up to 76.2 m (250 ft)
Annual Usage: Up to 4,535 kg (10,000 lb)

Dispense Points: 1 to 2
Typical Applications: High pressure grease to 579 bar (8400 psi)



Fire-Ball 425, 50:1

	1.5 (3.35)	517 (7500)	108 (4.25)	2.8-10.4 (40-150)	0.54m ³ /min (19 cfm) @ 4.8 bar (70 psi)	CS, Leather	1/2 in npt(f)	Slotted	3/8 in npt(f)
--	---------------	---------------	---------------	----------------------	--------------------------------------------------------	-------------	------------------	---------	------------------

306674/306982

Line Length‡: Up to 76.2 m (250 ft)
Annual Usage: 9,072 kg (20,000 lb) or more

Dispense Points: 4 or more
Typical Applications: High pressure grease to 517 bar (7500 psi)



Fire-Ball 425, 75:1

	.88 (1.95)	517 (7500)	108 (4.25)	2.8-7 (40-100)	0.736 m ³ /min (26 cfm) @ 7 bar (100 psi)	CS, Leather	1/2 in npt(f)	Slotted	3/8 in npt(f)
--	------------	---------------	---------------	-------------------	---------------------------------------------------------	-------------	------------------	---------	------------------

308777/306982

Line Length‡: Up to 152.5 m (500 ft)
Annual Usage: 6,804 kg (15,000 lb) or more

Dispense Points: 4 or more
Typical Applications: High pressure grease to 517 bar (7500 psi)



Fire-Ball 300, 15:1

	2.65 l/min (0.7 gpm)	186 (2700)	76 (3)	2.8-12.5 (40-180)	0.48 m ³ /min (17 cfm) @ 7 bar (100 psi)	CS, AL, Leather, PTFE, Rubber	3/8 in npt(f)	1 in npt(f) Straight Inlet	1/4 in npt(f)
--	-------------------------	---------------	-----------	----------------------	--------------------------------------------------------	-------------------------------	------------------	-------------------------------	------------------

306531

Line Length‡: Up to 76.2 m (250 ft)
Annual Usage: Up to 4,535 kg (10,000 lb)

Dispense Points: 1 to 2
Typical Applications: Medium Pressure Grease to 186 bar (2700 psi)



Fire-Ball 425, 10:1

	13.25 l/min (3.5 gpm)	124 (1800)	108 (4.25)	2.8-12.5 (40-180)	0.37 m ³ /min (13 cfm) @ 7 bar (100 psi)	Steel, Bass, Aluminum, Leather, Buna-N	1/2 in npt(f)	Slotted	1 in npt(f)
--	--------------------------	---------------	---------------	----------------------	--------------------------------------------------------	----------------------------------------	------------------	---------	----------------

309407

Line Length‡: Up to 152.4 m (500 ft)
Annual Usage: 9,072 kg (20,000 lb) or more

Dispense Points: 4 or more
Typical Applications: High pressure grease to 124 bar (1800 psi)

* Not recommended with hose reel

‡ Consult your local authorized Graco representative for line or pipe sizing

Grease Pumps Quick Reference



Floor-mounted



RAM-mount

See NXT Ordering Information for Instruction Manuals	Output Per Cycle	Output at 60 CPM* l/min. (gpm)	Maximum Fluid Pressure bar (psi)	Motor Size	Maximum Air Input Pressure bar (psi)
------------------------------------------------------	------------------	--------------------------------	----------------------------------	------------	--------------------------------------

Check-Mate, 14:1**

	500cc	26.0 (57.0)	96.5 (1400)	NXT 3400	6.9 (100)
--	-------	-------------	-------------	----------	-----------

Line Length †: Up to 30.5 m (100 ft)
Annual Usage: Up to 9,072 kg (20,000 lb.)

Dispense Points: 1
Typical Applications: Small maintenance facility

Check-Mate, 26:1

	500cc	26.0 (57.0)	179.3 (2600)	NXT 6500	6.9 (100)
--	-------	-------------	--------------	----------	-----------

Line Length †: Up to 76.2 m (250 ft)
Annual Usage: Up to 9,072 kg (20,000 lb.)

Dispense Points: 1 to 2 (simultaneous)
Typical Applications: Smaller continuous duty, maintenance facility

Check-Mate, 29:1

	250cc	13.0 (28.0)	200.0 (2900)	NXT 3400	6.9 (100)
--	-------	-------------	--------------	----------	-----------

Line Length †: Up to 76.2 m (250 ft)
Annual Usage: Up to 9,072 kg (20,000 lb.)

Dispense Points: 4 or more
Typical Applications: Medium continuous duty, maintenance facility

Check-Mate, 55:1

	250cc	13.0 (28.0)	379.2 (5500)	NXT 6500	5.2 (75)
--	-------	-------------	--------------	----------	----------

Line Length †: Up to 76.2 m (250 ft)
Annual Usage: Up to 9,072 kg (20,000 lb.)

Dispense Points: 1 to 2 (simultaneous)
Typical Applications: Smaller continuous duty, maintenance facility

Check-Mate, 63:1**

	100cc	5.2 (11.4)	310.3 (4500)	NXT 3400	5.0 (72)
--	-------	------------	--------------	----------	----------

Line Length †: Up to 76.2 m (250 ft)
Annual Usage: Up to 9,072 kg (20,000 lb.)

Dispense Points: 1 to 2 (simultaneous)
Typical Applications: Smaller continuous duty, maintenance facility

Check-Mate, 68:1**

	200cc	10.4 (22.8)	356.5 (5300)	NXT 6500	5.4 (78)
--	-------	-------------	--------------	----------	----------

Line Length †: Up to 152.5 m (500 ft)
Annual Usage: Up to 9,072 kg (20,000 lb.)

Dispense Points: 1 to 2 (simultaneous)
Typical Application: Smaller continuous duty, maintenance facility

* Graco recommends 20 CPM or less for supply applications.

**NXT Check-Mate pump is available in floor stand or RAM Package. See NXT package section of this book for more information.

Grease Pumps

Mini Fire-Ball® 225, 50:1

Features and Benefits

- Non-corrosive air motor design for long life
- Double-acting pump ensures fluid flow
- Robust grease inlet cage withstands the most abusive handling

Typical Applications

- Medium to high pressure, low to medium volume grease dispense
- Automotive dealerships
- Heavy-duty dealerships
- Fast lube and service centers
- Fleet service facilities
- Mining
- In-plant

Typical Fluids Handled

- Grease up to NLGI #2

Mini Fire-Ball 225, 50:1 Performance Chart

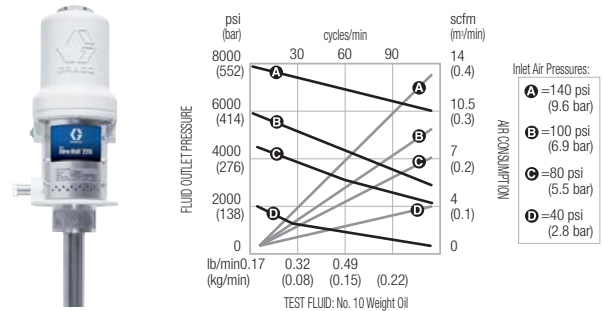

Fire-Ball 300, 15:1 Performance Chart

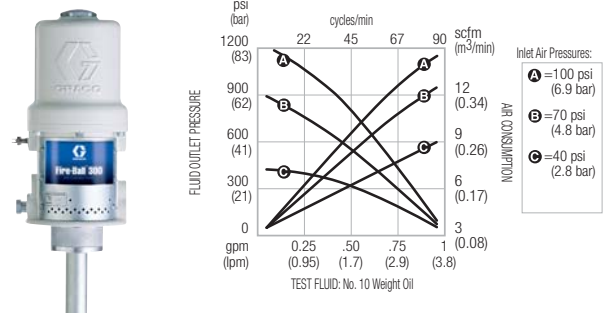

Fire-Ball 300, 50:1 Performance Chart

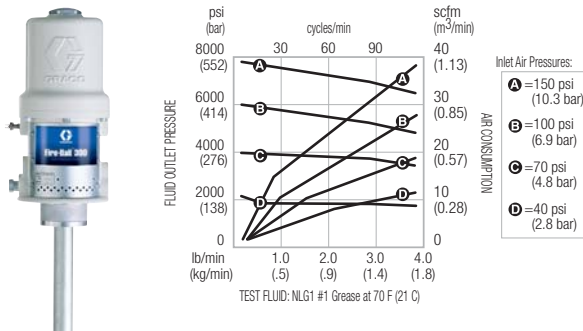

Fire-Ball 425, 10:1 Performance

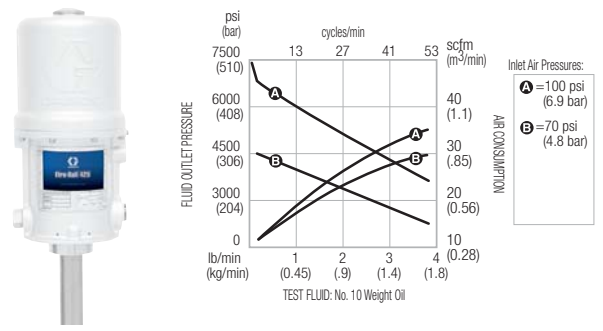

Fire-Ball 425, 50:1 Performance

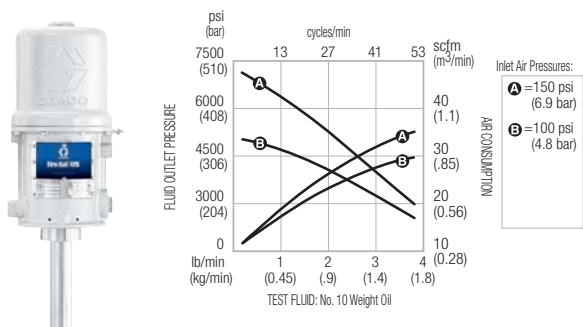

Fire-Ball 425, 75:1 Performance Chart

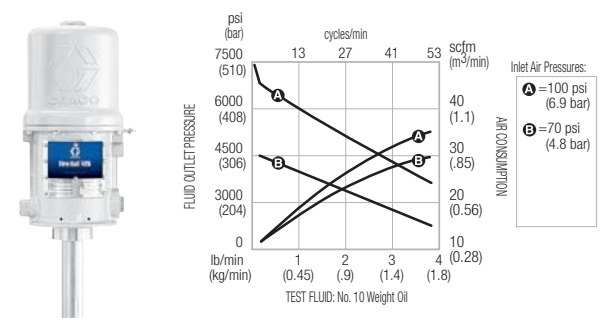

Grease Packages

Fire-Ball®

Mini Fire-Ball 225, 50:1

Packages	Portable Pail Dispenser	Stationary Pail Dispenser	Cart-Mounted Pail Dispenser	Stationary Supply	Stationary Supply	Portable w/ Caster Base	Portable w/ 2-Wheel Cart
Container Size	16 kg (35 lb)†	16 kg (35 lb) or 32 kg (70 lb)†	16 kg (35 lb) or 32 kg (70 lb)†	55 kg (120 lb)	180 kg (400 lb)	55 kg (120 lb)	55 kg (120 lb)
Package	246910*	246911*	246913*	246914*	246917*	246915*	246916*
Pump Only	246909	246909	246909	246780	246781	246780	246780
Dispense Kit	236058	236058	236058	222072	222072	236058	236058
Fluid Hose	3.7 m x 6.4 mm (12 ft x 1/4 in)	3.7 m x 6.4 mm (12 ft x 1/4 in)	3.7 m x 6.4 mm (12 ft x 1/4 in)	1.8 m x 6.4 mm (6 ft x 1/4 in)	1.8 m x 6.4 mm (6 ft x 1/4 in)	3.7 m x 6.4 mm (12 ft x 1/4 in)	3.7 m x 6.4 mm (12 ft x 1/4 in)
Air Hose	—	—	—	1.8 m x 9.5 mm (6 ft x 3/8 in)	1.8 m x 9.5 mm (6 ft x 3/8 in)	—	—
Follower Plate	220653	‡	‡	220654	223845	220654	220654
Cover	222059	204574	204574	204574	200326	204574	204574
Base/Cart	—	—	203650	—	—	203622	203650
Container	—	204134	204134	—	—	—	—
Instruction Manual	309967	309967	309967	309967	309967	309967	309967

* Order 9.5 mm (3/8 in) air regulator 109075 separately

‡ Order follower plate 220653 separately for 16 kg (35 lb) pails or 220654 for 32 kg (70 lb) bulk

† 16 kg (35 lb): pail; 32 kg (70 lb): bulk

Fire-Ball 300, 15:1, 50:1

Packages	Portable Pail Dispenser	Stationary Pail Dispenser	Stationary Pail Dispenser	Cart-Mounted Pail Dispenser	Cart-Mounted Pail Topper	Stationary Drum Dispenser	Cover-Mounted Drum Dispenser
Container Size	16 kg (35 lb)	16 kg (35 lb)	16 kg (35 lb) or 32 kg (70 lb)	16 kg (35 lb) or 32 kg (70 lb)	16 kg (35 lb)	55 kg (120 lb)	180 kg (400 lb)
15:1 Package	—	222078	—	—	—	220170	220171
15:1 Pump Only	—	206405	—	—	—	206699	206700
50:1 Package	222069*	—	225827*	225773*	226012*	—	—
50:1 Pump Only	239877	—	239877	239877	239877	—	—
50:1 Metered Package	245694†	—	—	245695†	—	—	—
Dispense Kit	222070	222080	222070	222070	222070	222081	222081
Fluid Hose	3.7 m x 6.4 mm (12 ft x 1/4 in)	4.6 m x 9.5 mm (15 ft x 3/8 in)	3.7 m x 6.4 mm (12 ft x 1/4 in)	3.7 m x 6.4 mm (12 ft x 1/4 in)	3.7 m x 6.4 mm (12 ft x 1/4 in)	7.6 m x 9.5 mm (25 ft x 3/8 in)	7.6 m x 9.5 mm (25 ft x 3/8 in)
Follower Plate	220653	—	‡	‡	—	—	—
Inductor Plate	—	—	—	—	204351	—	—
Cover	222059	222058	204575	204574	—	204574	200326
Cart	—	—	—	203650	203650	—	—
Container	—	—	204134	204134	—	—	—
Holster	—	—	203976	203976	203976	—	—
Elevator	—	—	—	—	203664	—	—
Instruction Manual	303878	307882	307878	307878	307878	307882	307882

* Use 9.5 mm (3/8 in) air regulator 109075; must be ordered separately

‡ Order follower plate 220653 for 16 kg (35 lb) containers, and follower plate 220654 for 32 kg (70 lb) containers; must be ordered separately

† Metered grease package includes 233807 Accu-Shot instead of 242056 Pro-Shot

Grease Packages

Fire-Ball®

Fire-Ball 300 Packages for 16-32 kg (35-70 lb) Containers

Packages	Portable Pail Dispenser	Stationary Pail Dispenser	Cart-Mounted Pail Dispenser	Cart-Mounted Pail Topper
Container Size	16 kg (35 lb)	16 kg (35 lb) or 32 kg (70 lb)	16 kg (35 lb) or 32 kg (70 lb)	16 kg (35 lb)
Package No.	222069*	225827*	225773*	226012*
Metered Package	245694†	—	245695†	—
Pump No.	239877			
Dispense Kit	222070			
Fluid Hose	3.7 m x 6.4 mm (12 ft x 1/4 in.)			
Follower Plate	220653	‡	‡	—
Cover	222059	204574		—
Holster	—	203976		
Container	—	204134		—
Cart	—	—	203650	
Elevator	—	—	—	203664
Inductor Plate	—	—	—	204351
Instruction Manual	307878			

* Use 9.5 mm (3/8 in.) air regulator 109075; must be ordered separately

‡ Order follower plate 220653 for 16 kg (35 lb) containers, and follower plate 220654 for 32 kg (70 lb) containers; must be ordered separately

† Metered grease package includes 233807 Accu-Shot instead of 242056 Pro-Shot



Portable Fire-Ball 300 3:1 with Pro-Shot (222069) shown



Accu-Shot™ (233807)

Fire-Ball 300 Packages for 55 kg (120 lb) Containers

Packages	Portable w/Caster Base	Portable w/ 2-Wheel Cart	Portable w/ Heavy-Duty Cart	Stationary Supply	Stationary Supply Topper-Inductor
Container Size kg (lb)	55 (120)				
Package No.	225006*	225026*	222245*	225014*	222073*
Metered Package	—	245696†	—	—	—
Pump No.	239887				
Dispense Kits	222070		222383	222072	—
Fluid Hose	3.7 m x 6.4 mm (12 ft x 1/4 in.)		7.6 m x 6.4 mm (25 ft x 1/4 in.)	1.8 m x 6.4 mm (6 ft x 1/4 in.)	
Air Hose	—	—	—	1.8 m x 9.5 mm (6 ft x 3/8 in.)	
Follower Plate	220654				—
Cover	204574		222060	204574	—
Holster	203976		—	—	—
Caster Base	203622	—	—	—	—
Cart	—	203650	222243	—	—
Elevator	—	—	—	—	204121
Pump Support	—	—	—	—	222074‡
Hold Down Kit	—	—	222061	—	—
Instruction Manual	307878			307880	306523

* Use 9.5 mm (3/8 in) air regulator 109075; must be ordered separately

‡ Pump support assembly includes dust cover, base, inductor plate and 1.8 m (6 ft) fluid & air hoses

† Metered grease package includes 233807 Accu-Shot instead of 242056 Pro-Shot



Portable Fire-Ball 300 with 2-Wheel Cart (225026) shown

Grease Packages

Fire-Ball®

Fire-Ball 300 Packages for 180 kg (400 lb) Containers

Packages	Stationary	Topper-Inductor
Container Size kg (lb)	180 (400)	
Package No.	225016*	226013*
Pump No.	239888	
Hose & Fitting Kit	222072	204467
Fluid Hose	1.8 m (6 ft) x 6.4 mm (1/4 in)	
Air Hose	1.8 m (6 ft) x 9.5 mm (3/8 in)	
Follower Plate	223845	—
Cover	200326	—
Carriage	—	204461
Elevator	—	204385
Inductor Plate	—	204353
Base	—	205339
Instruction Manual	307880	306556

* Use 9.5 mm (3/8 in) air regulator 109075; must be ordered separately

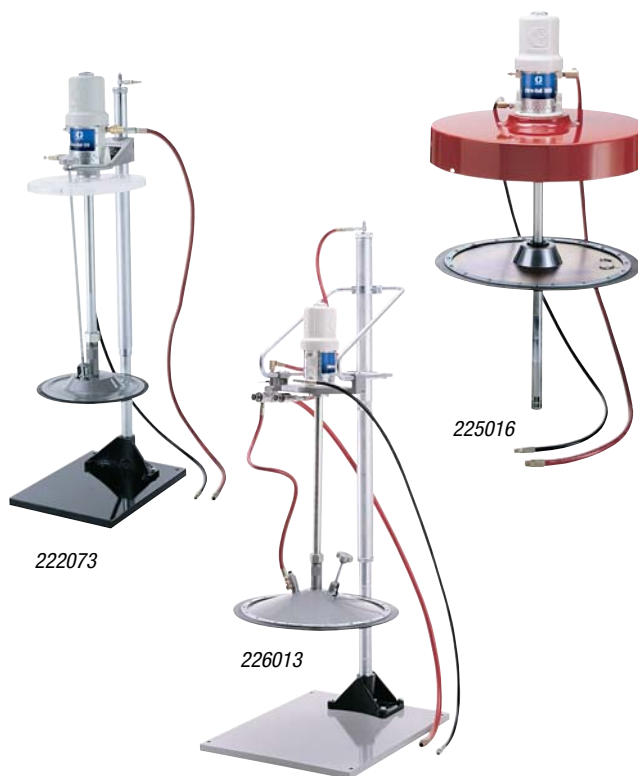

Fire-Ball 425, 50:1 for 55-180 kg (120-400 lb) Containers

Packages	Stationary Supply	Stationary Supply	Stationary Supply Topper-Inductor	Ram
Container Size kg (lb)	55 (120)	180 (400)		
Package No.	223108*	225781*	226018*	244905
Pump No.	205394	205395		
Hose Kit	222076		205102	222076
Fluid Hose	1.8 m x 9.5 mm (6 ft x 3/8 in)			
Air Hose	1.8 m x 12.7 mm (6 ft x 1/2 in)			
Cover	204574	200326	—	—
Follower Plate	223344	223846	—	—
Carriage	—	—	204461	—
Elevator	—	—	204385	—
Inductor Plate	—	—	205699	—
Base	—	—	205339	—
Ram	—	—	—	207279
Air Regulator	—	—	—	244844
Adapter Plate	—	—	—	162225
Adapter Kit	—	—	—	224266
Manual	307880		306556	309345

* Use 12.7 mm (1/2 in) air regulator/gauge 244844; must be ordered separately



Grease Packages

Fire-Ball®

Fire-Ball 425, 75:1

Packages	Cover-Mount	Cover-Mount	Inductor	Ram	Pail 16 or 32 kg (35 or 70 lb)	Bung or Cover
Container Size - kg (lb)	55 (120)	180 (400)	180 (400)	180 (400)	Pail Length	180 (400)
Package No.	244635*	244636*	244637*	244906	-	-
Pump No.	239729	239730	239730	239730	239731	965129
Hose & Fitting Kit	222076	222076	205102	222076	-	-
Drum Cover	204574	200326	-	-	204574	-
Follower Plate	223344	223846	-	-	†	-
Carriage	-	-	204461	-	-	-
Elevator	-	-	204385	-	-	-
Base	-	-	205339	-	-	-
Inductor	-	-	205699	-	-	-
Ram	-	-	-	207279	-	-
Air Regulator	-	-	-	244844	-	-
Adapter Plate	-	-	-	162225	-	-
Adapter Kit	-	-	-	224266	-	-
Manual	307880	307880	306556	309345	-	-

* Use 12.7 mm (1/2 in) air regulator 104266 and gauge 100960; must be ordered separately

† 16 kg (35 lb): 200653; 32 kg (70 lb): 223344

Fire-Ball 300, 50:1 and 425, 50:1, 75:1 Lube Truck Packages

Packages	Cover-Mounted	Cover-Mount	Cover-Mount	Cover-Mount
Container Size - kg (lb)	55 (120)	180 (400)	55 (120)	180 (400)
300, 50:1 Package	222085	222071	—	—
300, 50:1 Pump	239887	239888	—	—
425, 50:1 Package	—	—	223107	222075
425, 50:1 Pump	—	—	205394	205395
425, 75:1 Package	—	—	243817	243818
452, 75:1 Pump	—	—	239729	239730
Hose & Fitting Kit	222072	222072	222076	222076
Hose Length - m (ft)	1.8 (6)	1.8 (6)	1.8 (6)	1.8 (6)
Drum	Open-Head	Open-Head	Open-Head	Open-Head
Drum Cover	222060	207366	222060	207366
Follower Plate	220654	223845	223344	223846
Air Regulator	*	*	‡	‡
Hold-Down Kit	222061	207361	222061	207361
Manual	307880	307880	307880	307880

* Use 9.5 mm (3/8 in) air regulator/gauge 109075; must be ordered separately

‡ Use 12.7 mm (1/2 in) air regulator/gauge 24484; must be ordered separately



Grease Packages

Check-Mate®



Floor-mounted

See NXT Ordering Information for Instruction Manuals	Output Per Cycle	Output at 60 CPM* kg/min (lb/min)	Maximum Fluid Pressure bar (psi)	Motor Size	Maximum Air Input Pressure bar (psi)
------------------------------------------------------	------------------	-----------------------------------------	-------------------------------------	------------	--------------------------------------

Check-Mate, 14:1**

	500cc	26.0 (57.0)	96.5 (1400)	NXT 3400	6.9 (100)
--	-------	----------------	----------------	----------	-----------

Line Length †: Up to 30.5 m (100 ft)
Annual Usage: Up to 9,072 kg (20,000 lb)

Dispense Points: 1
Typical Applications: Small maintenance facility

Check-Mate, 26:1

	500cc	26.0 (57.0)	179.3 (2600)	NXT 6500	6.9 (100)
--	-------	----------------	-----------------	----------	-----------

Line Length †: Up to 76.2 m (250 ft)
Annual Usage: Up to 9,072 kg (20,000 lb)

Dispense Points: 1 to 2 (simultaneous)
Typical Applications: Smaller continuous duty, maintenance facility

Check-Mate, 29:1

	250cc	13.0 (28.0)	2900 (200.0 bar)	NXT 3400	6.9 (100)
--	-------	----------------	---------------------	----------	-----------

Line Length †: Up to 76.2 m (250 ft)
Annual Usage: Up to 9,072 kg (20,000 lb)

Dispense Points: 4 or more
Typical Applications: Medium continuous duty, maintenance facility

Check-Mate, 55:1

	250cc	13.0 (28.0)	379.2 (5500)	NXT 6500	6.9 (100)
--	-------	----------------	-----------------	----------	-----------

Line Length †: Up to 76.2 m (250 ft)
Annual Usage: Up to 9,072 kg (20,000 lb)

Dispense Points: 1 to 2 (simultaneous)
Typical Applications: Smaller continuous duty, maintenance facility

Check-Mate, 63:1**

	100cc	5.2 (11.4)	310.3 (4500)	NXT 3400	5.0 (72)
--	-------	---------------	-----------------	----------	----------

Line Length †: Up to 76.2 m (250 ft)
Annual Usage: Up to 9,072 kg (20,000 lb)

Dispense Points: 1 to 2 (simultaneous)
Typical Applications: Smaller continuous duty, maintenance facility

Check-Mate, 68:1**

	200cc	10.4 (22.8)	356.5 (5300)	NXT 6500	5.4 (78)
--	-------	----------------	-----------------	----------	----------

Line Length †: Up to 152.5 m (500 ft)
Annual Usage: Up to 9,072 kg (20,000 lb.)

Dispense Points: 1 to 2 (simultaneous)
Typical Application: Smaller continuous duty, maintenance facility



RAM-mount

* Graco recommends 20 CPM or less for supply applications.
**NXT Check-Mate pump is available in floor stand or RAM Package.
See NXT package section of this book for more information.

Grease Packages

NXT™ Check-Mate® Packages

Ordering Information

Package Number with DataTrak™	247973	247976	247974	247977	247975	247978
Package Number without DataTrak	24E006	24E007	24E008	24E009	24E010	24E011
Ratio	14:1	26:1	29:1	55:1	63:1	68:1
Pump with DataTrak	P14MCS	P26MCS	P29MCS	P55MCS	P63MCS	P68MCS
Pump w/o DataTrak	P14DCS	P26DCS	P29DCS	P55DCS	P63DCS	P68DCS
Mounting	Floor Stand (223952)	Floor Stand (223952)	Floor Stand (223952)	Floor Stand (223952)	Floor Stand (223952)	Floor Stand (223952)
3/4 in x 1.8 m (6 ft) Air Hose	208610	208610	208610	208610	208610	208610
1 in x 1.8 m (6 ft) Fluid Hose	115042	244657	244657	244657	244657	244657
System Manual	312863	312863	312863	312863	312863	312863
Pump Manual	312376	312376	312376	312376	312376	312376
Pump Lower Manual	312375	312375	312375	312375	312375	312375
Motor Manual	311238	311238	311238	311238	311238	311238

*Graco recommends 20 cpm or less for supply applications

Performance Charts

A = 7 bar (100 psi) C = 2.8 bar (40 psi)
 B = 5.0 bar (70 psi) D = 6.3 bar (90 psi)

Test Fluid : #10 Weight Oil for all pumps

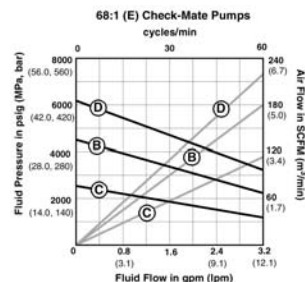
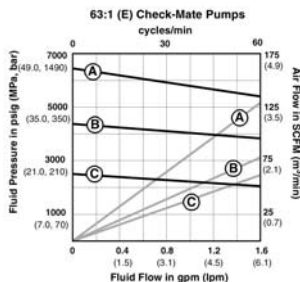
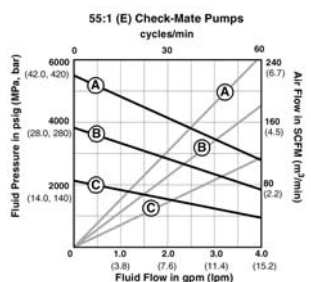
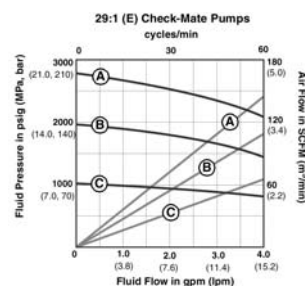
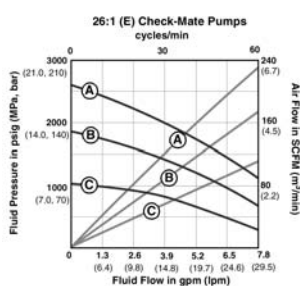
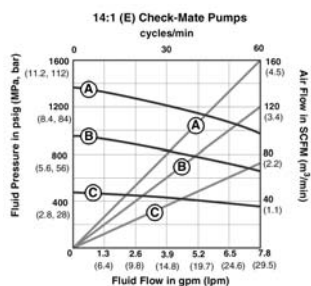

Ordering Information

NXT Check-Mate RAM Packages			
Ratio	14:1	63:1	68:1
Package Number with DataTrak	247979	247980	247981
Package Number without DataTrak	24E780	24E781	24E782
Mounting	RAM System	RAM System	RAM System
Operation Manual	312371	312371	312371
Repair and Parts Manual	312373	312373	312373

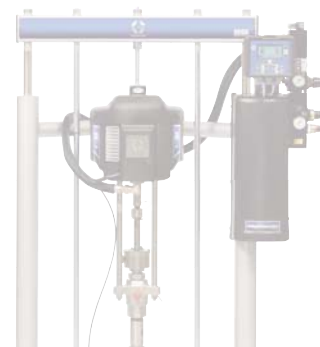

Diaphragm Pumps

Air-Operated Double Diaphragm Transfer Pumps



D31255

241906

647016

DB3525

DF3525

DK3525

Ordering Information and Technical Specifications

Key	OT = Oil Transfer	OE = Oil Evacuation	WA = Water, Anti-Freeze	FD = Fuel Dispense (with 3.4 bar (50 psi) relief valve)	FT = Fuel Transfer	WWS = Windshield Wash Solution					
Body/Diaphragm Description	Part Number	Typical Application	Max. Air SCFM	Air Inlet NPT	Max. bar (psi)	Fluid Inlet/Outlet	Free Flow gpm (lpm)	Air Valve Replacement Kit	Kits (Seats, Balls, Diaphragms)	Diaphragm Kit	Manual
307 3/8 in Diaphragm Pump Acetal/TPE	D31255	OT, WA, WWS	7 ⁽¹⁾	1/4	7 (100)	3/8	7 (31.8)	239952	D03255	D03005	308553
515 3/4 in Diaphragm Pump Aluminum/Buna N	241906	OT, OE, WA, WWS	28 ⁽¹⁾	1/4	7 (100)	3/4	16 (60.6)	241657	D05277	D05007	308573
716 3/4 in Diaphragm Pump Acetal/Buna Dual Inlet	243669	50/50 WWS, WA	28 ⁽¹⁾	1/4	7 (100)	3/4	16 (61)	241657	D05277	D05007	308573
1 in Diaphragm Pumps 1050A Aluminum/TPE (UL)	647016	OE, WA, FT (leaded fuel only)	67	1/2	7 (100)	1	50 (189)	24B766	24B634 and 24B639	24B624	313597
1050A Aluminum/TPE (UL)	647648	FD	20 ⁽²⁾	1/2	3.5 (50)	1	38 (144)	24B766	24B634 and 24B639	24B624	313597
1590 1-1/2 in Diaphragm Pump Aluminum/TPE	DB3525	OT, OE, WA	90 ⁽³⁾	1/2	8.3 (120)	1 1/2	90 (341)	236273	D0B525	D0B005	308441
2150 2 in Diaphragm Pump Aluminum/TPE	DF3525	OT, OE, WA	175 ⁽³⁾	1/2	8.3 (120)	2	150(567)	236273	D0F525	D0F005	308368
3275 3 in Diaphragm Pump Aluminum/TPE	DK3525	OT, OE, WA	325 ⁽³⁾	3/4	8.3 (120)	3	275 (1041)	238765	D0K525	D0K005	308639

NOTE: All pumps are 1:1 ratio ⁽¹⁾ Max air use at 7.0 bar (100 psi) ⁽²⁾ Max air use at 3.4 bar (50 psi) ⁽³⁾ Max air use at 120 psi (8.0 bar)

Mounting Accessories

Pump	307	515/716	1050	1590	2150	3275
Air Line Filter	110146	110146	106148	106149	106150	106150
Air Regulator & Gauge	110147	110147	244844	202858	206199	207651
Air Quick-Connect Coupler	208536, 1/4 npt(f)	208536, 1/4 npt(f)	110199, 1/2 npt(f)	110199, 1/2 npt(f)	110199, 1/2 npt(f)	N/A
Air Quick-Connect Nipple	169970, 1/4 npt(m)	169970, 1/4 npt(m)	110196, 1/2 npt(f)	110196, 1/2 npt(f)	110196, 1/2 npt(f)	N/A
Bleed Type Air Valve	110223	110223	110224	110225	110225	110226
Wall Bracket	224835	224835	24C637	N/A	N/A	N/A
Thermal Relief Kit	238899	238428	238428	N/A	N/A	N/A
Thermal Relief Valves 10.3 bar (150 psi)	113497 al/bn, 112119 ss/ff	113497 al/bn, 112119 ss/ff	113497 al/bn, 112119 ss/ff	113497 al/bn, 112119 ss/ff	113497 al/bn, 112119 ss/ff	113497 al/bn, 112119 ss/ff
Grounding Wire and Clamp	222011	222011	222011	222011	222011	222011
Suction Hose Kit	236054	236054	236054	N/A	N/A	N/A
Flange Adapter Kit	N/A	N/A	N/A	N/A	N/A	N/A
Dual Inlet Manifold	N/A	*	685984 **	N/A	N/A	N/A
Instruction Manual	308553	308573 & 308981	308326 & 308479	308441	308368	308639

*243669 comes with dual inlet **Dual inlet must be ordered separately for 685984

Other Products available from Graco

Electronic & Mechanical Meters & Dispense Valves



Up to
19 l/min.
(6 gpm)

LDM and LDP Meters

- 69 bar (1,000 psi)
- Manual and pre-set dispense
- Dispenses motor oils, ATF, gear lube and anti-freeze
- Automatic nozzle only
- Indoor use
- Multiple extensions available



Up to
53 l/min.
(14 gpm)

SDM and SDP Meters

- 103 bar (1,500 psi)
- Manual and pre-set dispense
- Dispenses motor oils, ATF, gear lube and anti-freeze
- High flow
- Indoor or outdoor use
- Multiple extensions available



Up to
53 l/min.
(14 gpm)

Matrix™ Meter

- Dealerships, fleets, mining, and off-road, construction service
- Works with Matrix™ Total Fluid Management System™ to control and track inventories
- Up to 53 l/min. (14 gpm)
- Up to 3 presets



Up to
57 l/min.
(15 gpm)

SDV15 Control Valve

- 103 bar (1,500 psi)
- Dispenses motor oils, ATF, gear lube and anti-freeze
- Sturdy cast body designed for use in tough environments
- Lock-on trigger
- Indoor or outdoor use
- Multiple extensions available



Up to
76 l/min.
(20 gpm)

XDV20 Control Valve

- 103 bar (1,500 psi)
- Dispenses motor oils, ATF, gear lube and anti-freeze
- High flow valve
- Sturdy cast body designed for use in tough environments
- Twist-lock-on/off trigger
- Indoor or outdoor use
- Multiple extensions available



Up to
53 l/min.
(14 gpm)

SDI15 In-Line Meter

- 103 bar (1,500 psi)
- Dispenses motor oils, ATF, and anti-freeze
- High flow electronic meter displays in pints, quarts, liters or gallons
- Indoor use



Up to
15 l/min.
(4 gpm)

Mechanical Meter

- 69 bar (1,000 psi)
- Manual and pre-set dispense
- Dispenses a variety of petroleum and synthetic based oils and anti-freeze
- Indoor and outdoor use

Hose Reels



LD Series Enclosed

- Simple to install - mounts in minutes
- Enclosed reel for safety and protection-compact enclosure extends hose life
- Full flow swivel - maximizes fluid output while minimizing pressure loss
- Easily add or decrease spring tension while pressurized



SD Composite Series

- Designed for small service garages and repair shops
- Handles hose lengths up to 20 m (65 ft)
- Structurally reinforced frame doesn't flex when handling hose
- Multiple mounting options
- Lightweight composite spool resists dents and corrosion
- Compact design easily fits inside tool bench or cabinet



SD Steel Series

- Designed for daily use by professional mechanics
- Handles hose lengths up to 20 m (65 ft)
- Long-lasting spring provides constant spring torque through the entire range of motion
- Multiple mounting options
- Steel spool for demanding applications
- Open swivel ports ensure high fluid flow with minimal pressure loss



XD Series

- Designed for robust/heavy-duty applications such as mobile lube trucks or large equipment service
- Hose lengths up to 20 m
- Dual pedestal frame provides increased strength for extreme-duty applications
- Long lasting spring is sealed for protection against the weather
- Durable steel spool rides on sealed roller bearings to ensure trouble-free performance



700 Series

- Fully ported swivel and shaft for unrestricted flow
- Handles hose lengths up to 23 m (75 ft)
- Heavy-duty ball bearings outlast sleeved-type bearings
- Easy rewind with minimal hose guidance
- Overhead mounting kit available



750 Series

- Heavy-duty, high volume reel
- Handles hose lengths up to 15 m (50 ft)
- Industrial-grade paint for high abrasion and corrosion resistance
- Full-flow shaft
- Heavy-duty brackets and springs
- Rugged base and hose rollers
- Heavy-duty latch mechanism



Enclosures

- Enclosures provide protection to extend the life of hoses and bearings
- Designed for enclosing the LD and SD single pedestal reels
- End caps are easily removed for easy access to reels
- Enclosure mounting channels available to accommodate one to six reels



ABOUT GRACO

Founded in 1926, Graco is a world leader in fluid handling systems and components. Graco products move, measure, control, dispense and apply a wide range of fluids and viscous materials used in vehicle lubrication, commercial and industrial settings.

The company's success is based on its unwavering commitment to technical excellence, world-class manufacturing and unparalleled customer service. Working closely with qualified distributors, Graco offers systems, products and technology that set the quality standard in a wide range of fluid handling solutions. Graco provides equipment for spray finishing, protective coating, paint circulation, lubrication, and dispensing sealants and adhesives, along with power application equipment for the contractor industry. Graco's ongoing investment in fluid management and control will continue to provide innovative solutions to a diverse global market.

GRACO LOCATIONS

CONTACT

MAILING ADDRESS

P.O. Box 1441
Minneapolis, MN 55440-1441
Tel: 612.623.6000
Fax: 612.623.6777

AMERICAS

MINNESOTA

Worldwide Headquarters
Graco Inc.
88-11th Avenue N.E.
Minneapolis, MN 55413

EUROPE

BELGIUM

European Headquarters
Graco N.V.
Industrieterrein-Oude Bunders
Slakweidestraat 31
3630 Maasmechelen,
Belgium
Tel: 32.89.770.700
Fax: 32.89.770.777

ASIA PACIFIC

JAPAN

Graco K.K.
1-27-12 Hayabuchi
Tsuzuki-ku
Yokohama City, Japan 2240025
Tel: 81.45.593.7300
Fax: 81.45.593.7301

ASIA PACIFIC

CHINA

Graco Hong Kong Ltd.
Representative Office
Room 118 1st Floor
No.2 Xin Yuan Building
No.509 Cao Bao Road
Shanghai, P.R. China 200233
Tel: 86.21.649.50088
Fax: 86.21.649.50077

ASIA PACIFIC

KOREA

Graco Korea Inc.
Choheung Bank Building
4th Floor #1599
Gwanyang-Dong, Dongan-Ku,
Anyang-Si, Gyunggi-Do,
Korea 431-060
Tel: 82(Korea).31.476.9400
Fax: 82(Korea).31.476.9801

All written and visual data contained in this document are based on the latest product information available at the time of publication. Graco reserves the right to make changes at any time without notice.

Graco is certified ISO 9001.

Europe
+32 89 770 700
FAX +32 89 770 777
WWW.GRACO.COM