

NXT[®] Air Motor

311238ZAL
EN

For use with high performance finishing and coating pumps in hazardous or non-hazardous locations. For professional use only.

100 psi (0.7 MPa, 7.0 bar) Maximum Working Pressure



Important Safety Instructions

Read all warnings and instructions in this manual.
Save these instructions.
See page 3 for model information.

With Linear Sensor

Standard

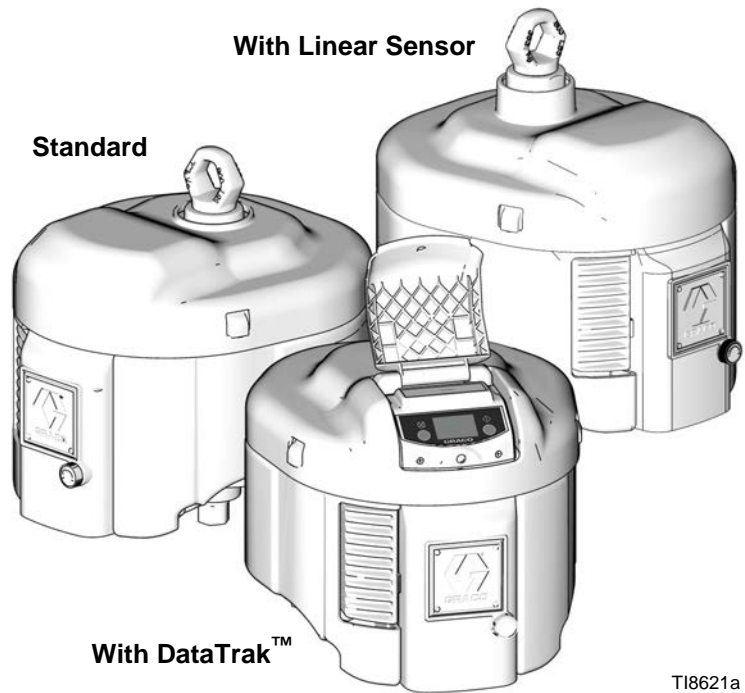

With DataTrak™

T18621a

Models with DataTrak™ display include agency approvals listed below.



Intertek
9902471
Class I, Div 1
Group D T3A



Ex ia IIA T3 Ga
ITS13ATEX27862X

Updated technical information and repair videos are available at www.graco.com. Click on "Tech Support", and then enter "NXT" in the "Search by Keyword" field.

Contents

Models	3	Repair	21
Air Motor Part No. Matrix	3	Preventive Maintenance Schedule	21
Air Motor Part Nos.	4	Tools Required	21
Warnings	6	Pressure Relief Procedure	21
Related Manuals	7	Air Valve Repair	21
Component Identification	8	Cylinder and Piston Repair	25
De-icing Control (F)	9	Poppet Repair	28
Integrated Air Control Module Accessory	9	Replace the Linear Sensor (if present)	29
Motor Lubrication	10	Remote DataTrak Connection Kit NXT406	30
Grounding	10	Parts	31
DataTrak Controls and Indicators	11	Air Motor Parts Drawing	
DataTrak Operation	12	(Shown with DataTrak and Low Noise Exhaust)	
Setup Mode	12	31	
Run Mode	12	Air Motor Parts Drawing (Shown with Linear	
Replace the DataTrak Module Battery or Fuse .	15	Sensor)	32
Troubleshooting	16	NXT Model 2200 Air Motors	33
LED is flashing	16	NXT Model 3400 Air Motors	35
Air Motor will not run with DataTrak	16	NXT Model 6500 Air Motors	37
Air Motor will not run all models	17	Air Motor Parts Drawing (for use with Remote	
Erratic motor operation	18	DataTrak)	39
Erratic air pressure with built in air control	19	Air Valve	41
Air continuously exhausting from motor	19	Dimensions	43
		Accessories	43
		Mounting Hole Diagrams	44
		Technical Data	45
		Graco Standard Warranty	50
		Graco Information	50

Models

Air Motor Part No. Matrix

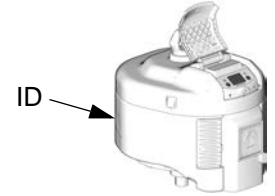

Check your motor's identification plate (ID) for the 6-digit part number of your motor. Use the following matrix to define the construction of your motor, based on the six digits. For example, Motor Part No. **N 6 5 D T 0** represents an NXT motor (**N**), 6500 cc per stroke (**6 5**), with de-icing exhaust (**D**) and DataTrak monitoring (**T**). The last digit (**0**) is unassigned.



N	6 5		D		T		0	
First Digit (Motor)	Second and Third Digits (motor size in cc per stroke)		Fourth Digit (Exhaust Type)		Fifth Digit (Data Monitoring)		Sixth Digit (unassigned)	
N (NXT Air Motor)	65	6500	D	De-icing	N	None	0	None assigned
	34	3400	L	Low noise	T	DataTrak	2	
	22	2200	R	Remote exhaust (see note below)	R	Remote DataTrak		
					H	Linear Sensor		

 Remote exhaust models have a 1 in. npt(f) exhaust outlet, allowing installation of a muffler or plumbing to route exhaust to a remote location.

 Remote DataTrak models do not have the DataTrak display on the motor. An external plug connects to systems using a remote display interface. See pages 39-40 for parts.

							
Do not operate the remote exhaust air motor without a plumbed exhaust line or muffler installed.							

Air Motor Part Nos.





Air Motor Part No.	Series	NXT Model	Piston Diameter, in. (mm)	De-Ice	Low Noise	Remote Exhaust	Includes DataTrak™	Includes Remote DataTrak™	Includes Linear Sensor
N22DN0	L	2200	6.0 (152)	✓					
N22DT0	L	2200	6.0 (152)	✓			✓		
N22DH0	L	2200	6.0 (152)	✓					✓
N22LN0	L	2200	6.0 (152)		✓				
N22LT0	L	2200	6.0 (152)		✓		✓		
N22LR0	L	2200	6.0 (152)		✓			✓	
N22LH0	L	2200	6.0 (152)		✓				✓
N22RN0	L	2200	6.0 (152)			✓			
N22RT0	L	2200	6.0 (152)			✓	✓		
N22RH0	L	2200	6.0 (152)			✓			✓
N34DN0	L	3400	7.5 (191)	✓					
N34DT0	L	3400	7.5 (191)	✓			✓		
N34DH0	L	3400	7.5 (191)	✓					✓
N34LN0	L	3400	7.5 (191)		✓				
N34LN2	L	3400	7.5 (191)		✓				
N34LT0	L	3400	7.5 (191)		✓		✓		
N34LR0	L	3400	7.5 (191)		✓			✓	
N34LH0	L	3400	7.5 (191)		✓				✓
N34RN0	L	3400	7.5 (191)			✓			
N34RT0	L	3400	7.5 (191)			✓	✓		
N34RH0	L	3400	7.5 (191)			✓			✓
N65DN0	L	6500	10.375 (264)	✓					
N65DT0	L	6500	10.375 (264)	✓			✓		
N65DH0	L	6500	10.375 (264)	✓					✓
N65LN0	L	6500	10.375 (264)		✓				
N65LN2	L	6500	10.375 (264)		✓				
N65LT0	L	6500	10.375 (264)		✓		✓		
N65LR0	L	6500	10.375 (264)		✓			✓	
N65LH0	L	6500	10.375 (264)		✓				✓
N65RN0	L	6500	10.375 (264)			✓			
N65RT0	L	6500	10.375 (264)			✓	✓		
N65RH0	L	6500	10.375 (264)			✓			✓
257055	L	6500	10.375 (264)	✓					✓☼

☼ Air motor includes potted linear sensor approved for use in hazardous locations, but only when it is used with XM



plural component sprayers.

Warnings

The following warnings are for the setup, use, grounding, maintenance, and repair of this equipment. The exclamation point symbol alerts you to a general warning and the hazard symbols refer to procedure-specific risks. Refer back to these Warnings. Additional, product-specific warnings may be found throughout the body of this manual where applicable.

 WARNING	
	<p>FIRE AND EXPLOSION HAZARD</p> <p>Flammable fumes, such as solvent and paint fumes, in work area can ignite or explode. To help prevent fire and explosion:</p> <ul style="list-style-type: none"> • Use equipment only in well ventilated area. • Eliminate all ignition sources; such as pilot lights, cigarettes, portable electric lamps, and plastic drop cloths (potential static arc). • Keep work area free of debris, including solvent, rags and gasoline. • Do not plug or unplug power cords, or turn power or light switches on or off when flammable fumes are present. • Ground all equipment in the work area. See Grounding instructions. • Use only grounded hoses. • Hold gun firmly to side of grounded pail when triggering into pail. • If there is static sparking or you feel a shock, stop operation immediately. Do not use equipment until you identify and correct the problem. • Keep a working fire extinguisher in the work area.
	<p>SPECIAL CONDITIONS FOR SAFE USE</p> <p>Equipment must comply with the following conditions to avoid a hazardous condition which can cause fire or explosion.</p> <ul style="list-style-type: none"> • All label and marking material must be cleaned with a damp cloth (or equivalent). • The electronic monitoring system is required to be grounded. See Grounding instructions.
	<p>SKIN INJECTION HAZARD</p> <p>High-pressure fluid from gun, hose leaks, or ruptured components will pierce skin. This may look like just a cut, but it is a serious injury that can result in amputation. Get immediate surgical treatment.</p> <ul style="list-style-type: none"> • Do not point gun at anyone or at any part of the body. • Do not put your hand over the spray tip. • Do not stop or deflect leaks with your hand, body, glove, or rag. • Do not spray without tip guard and trigger guard installed. • Engage trigger lock when not spraying. • Follow Pressure Relief Procedure in this manual, when you stop spraying and before cleaning, checking, or servicing equipment.
	<p>PRESSURIZED EQUIPMENT HAZARD</p> <p>Fluid from the gun/dispense valve, leaks, or ruptured components can splash in the eyes or on skin and cause serious injury.</p> <ul style="list-style-type: none"> • Follow Pressure Relief Procedure in this manual, when you stop spraying and before cleaning, checking, or servicing equipment. • Tighten all fluid connections before operating the equipment. • Check hoses, tubes, and couplings daily. Replace worn or damaged parts immediately.

! WARNING

	<p>MOVING PARTS HAZARD</p> <p>Moving parts can pinch or amputate fingers and other body parts.</p> <ul style="list-style-type: none"> • Keep clear of moving parts. • Do not operate equipment with protective guards or covers removed. • Pressurized equipment can start without warning. Before checking, moving, or servicing equipment, follow the Pressure Relief Procedure in this manual. Disconnect power or air supply.
	<p>EQUIPMENT MISUSE HAZARD</p> <p>Misuse can cause death or serious injury.</p> <ul style="list-style-type: none"> • Do not operate the unit when fatigued or under the influence of drugs or alcohol. • Do not exceed the maximum working pressure or temperature rating of the lowest rated system component. See Technical Data in all equipment manuals. • Use fluids and solvents that are compatible with equipment wetted parts. See Technical Data in all equipment manuals. Read fluid and solvent manufacturer's warnings. For complete information about your material, request MSDS forms from distributor or retailer. • Check equipment daily. Repair or replace worn or damaged parts immediately with genuine Graco replacement parts only. • Do not alter or modify equipment. • Use equipment only for its intended purpose. Call your Graco distributor for information. • Route hoses and cables away from traffic areas, sharp edges, moving parts, and hot surfaces. • Do not kink or over bend hoses or use hoses to pull equipment. • Keep children and animals away from work area. • Comply with all applicable safety regulations.
	<p>PERSONAL PROTECTIVE EQUIPMENT</p> <p>You must wear appropriate protective equipment when operating, servicing, or when in the operating area of the equipment to help protect you from serious injury, including eye injury, inhalation of toxic fumes, burns, and hearing loss. This equipment includes but is not limited to:</p> <ul style="list-style-type: none"> • Protective eyewear • Clothing and respirator as recommended by the fluid and solvent manufacturer • Gloves • Hearing protection

Related Manuals

Component manuals in U.S. English:

Manual	Description
311239	Integrated Air Control Modules Instructions-Parts
311486	DataTrak Conversion Kit Instructions-Parts
312148	NXT Air Motor Mounting Conversion Instructions-Parts
3A0293	Air Controls Instructions-Parts
406656	NXT135 Air Valve Seal Kit
406657	NXT144 Air Valve Rebuild Kit
406658	Air Motor Repair Kits
406820	NXT145 Replacement Kit

Component Identification

Key for FIG. 1

- | | | | |
|---|--|---|--|
| A | Air Inlet, 3/4 npt(f) | H | DataTrak module (see pages 10-15; not present on all models) |
| B | Bleed-Type Master Air Valve | J | Runaway Solenoid (component 1) |
| C | Air Regulator Adjustment Knob | K | DataTrak Sensors (component 2) |
| D | Air Pressure Gauge | L | Air Valve Inlet Port, 3/4 npt(f) |
| E | Air Filter (out of view; located at rear of air control kit) | M | Safety Relief Valve |
| F | De-icing Control | | |
| G | Air Valve (behind cover) | | |

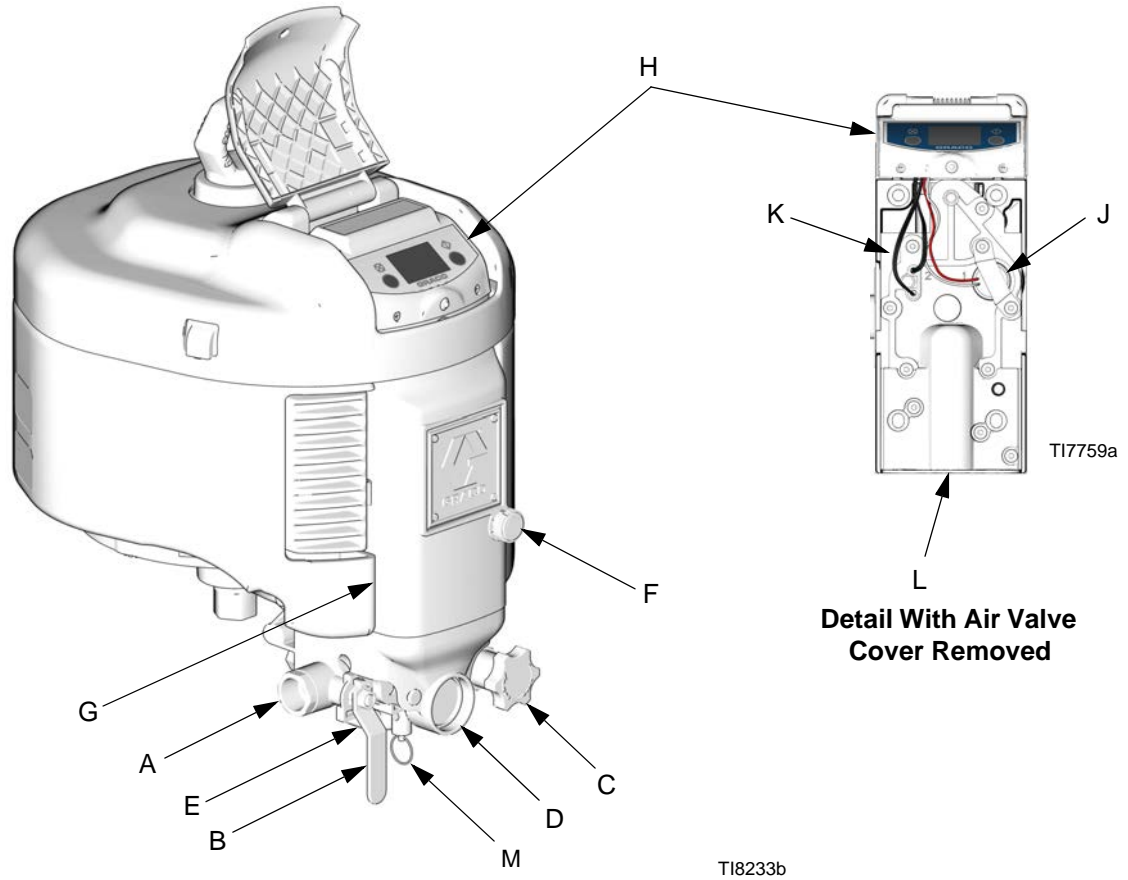

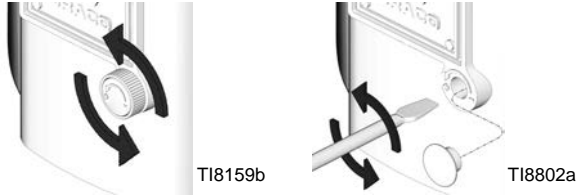

FIG. 1: Component Identification (Model Shown with DataTrak Module and Accessory Air Control Kit)

De-icing Control (F)

Open with knob or flat blade screwdriver to reduce icing. If needed, adjust enough warm feed air bleed to eliminate icing.

 Low noise models have exhaust baffles that can accumulate ice easily.





Integrated Air Control Module Accessory

 Accessory Air Control Kits include air line components in an integrated assembly. Order the kits separately. See manual 311239 for installation instructions.

- **NXT011** with locking air regulator and 110 psi (0.76 MPa, 7.6 bar) relief valve
- **NXT031** with locking air regulator and 75 psi (0.51 MPa, 5.1 bar) relief valve
- **NXT021** with non-locking air regulator and 110 psi (0.76 MPa, 7.6 bar) relief valve.

Bleed-type Master Air Valve (B)

						
Trapped air can cause the pump to cycle unexpectedly, which could result in serious injury from splashing or moving parts.						

- Required in your system to relieve air trapped between it and the air motor when the valve is closed.
- Be sure the valve is easily accessible from the pump and located downstream from the air regulator.

Air Regulator (C)

Adjusts air pressure to the motor and fluid outlet pressure of pump. Locate it close to the pump. Install a gauge (D) to read air pressure.

Safety Relief Valve (M)

Automatically opens to relieve air pressure, to prevent pump overpressurization.

Air Filter (E)

Removes harmful dirt from compressed air supply.

 Graco recommends using an air filter with a minimum measurement of 40 micron.

Motor Lubrication

Graco does not require lubrication beyond the grease installed at the factory or through regular maintenance. With good quality compressed air and normal ambient conditions NXT air motors will run millions of cycles without additional lubrication.

However, if any of the following criteria apply to your system, you will benefit from installing a 3/4 in. air line lubricator in the air line before the air motor or from occasionally adding oil to an air filter cup.

- Air supply does not contain any oil.
- Air supply is very wet.
- Air supply is very dry.
- Air motor is run at low air pressure.
- Air motor is run in unusually hot or cold environments.

Areas that benefit from lubrication:

- main piston o-rings(17),
- sliding valve spool(119/108), and
- motor detent assembly (113).

Add Lubrication

The three methods for adding lubrication are described below.

Lubricate Air Valve

Perform these steps annually, or more often depending on your duty cycle, air pressure, and air quality. Use a high quality lithium-based grease.

1. Remove the 10 air valve cover screws (124) and air valve cover (112).
2. Grease all visible moving parts, especially detent (113) and valve pistons (119).

Lubricate Air Filter Bowl

If using a motor with integrated air controls, add 50-75 ml of oil to the air filter bowl and run the motor for a few minutes at a fast cycle rate. The oil will move through the air valve and main piston.

 It is normal for some oil to come out through the exhaust.

Add Accessory Air Lubricator



If using an air motor with integrated air controls, add an accessory airline lubricator* to the motor inlet. The oil will move through the air filter.

 Depending on air quality you may need to change the air filter more frequently.

* Graco offers airline lubricators for NXT air motors. Order 214848 (1/2 in.) for NXT 2200 and NXT 3400 air motors. Order 214849 (3/4 in.) for NXT 6500 air motors.

If using an air motor without integrated air controls, add a standard type filter/regulator/lubricator that is sized for the specific air motor, such as 217073 (3/4 in.) or 217072 (1/2 in.).

Grounding

						
The equipment must be grounded to reduce the risk of static sparking. Static sparking can cause fumes to ignite or explode. Grounding provides an escape wire for the electric current.						

The equipment must be grounded. Grounding reduces the risk of static and electric shock by providing an escape wire for the electrical current due to static build up or in the event of a short circuit.

See FIG. 2. Use the ground screw (60) and lockwasher (61) to attach Part No. 244524 Ground Wire (GW) at the rear of the air motor. Tighten the screw securely. Connect the other end of the ground wire to a true earth ground.

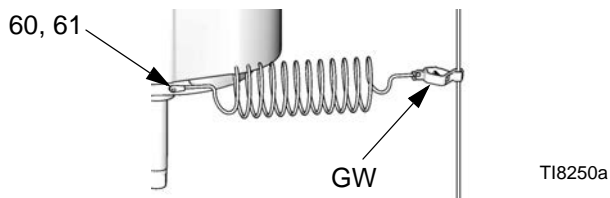

FIG. 2. Ground Wire

DataTrak Controls and Indicators

 DataTrak is included with certain models. See page 3 for a list of models featuring DataTrak.

It is recommended that a 3/4 in. air line lubricator be used with DataTrak models.

For remote DataTrak models, see your system operation manuals.

To prevent damage to the soft key buttons, do not press the buttons with sharp objects such as pens, plastic cards, or fingernails.

Key for Fig. 3

- | | | | |
|---|--|----|--|
| T | Runaway Limit, in cycles per minute (user settable; 00=OFF) | PF | Prime/Flush Key (Enables Prime/Flush mode. While in Prime/Flush mode, runaway protection is disabled and the batch totalizer [BT] will not count.) |
| U | Lower Displacement (user settable) | RK | Reset Key (Resets faults. Press and hold for 3 seconds to clear the batch totalizer.) |
| V | Flow Rate Units (user settable to \updownarrow /min, gpm [US], gpm [Imperial], oz/min [US], oz/min [Imperial], l/min, or cc/min) | CF | Cycle/Flow Rate |
| W | LED (fault indicator when lit) | BT | Batch Totalizer |
| X | Diagnostic Reference Card (see TABLE 1, page 14) | GT | Grand Totalizer |
| Y | Display | RT | Runaway Toggle (enable/disable) |
| | | UT | E1 Toggle |
| | | DT | E2 Toggle |
| | | ST | E5 Toggle |

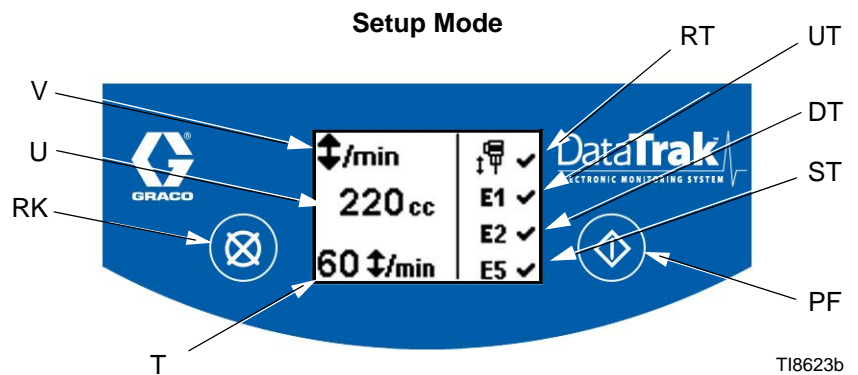
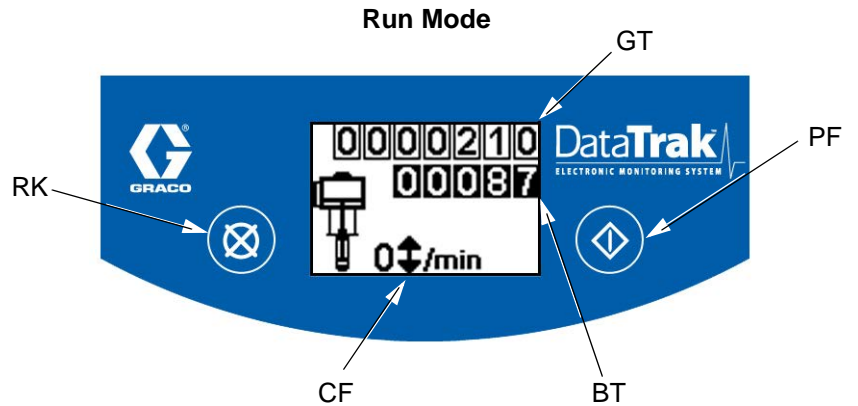
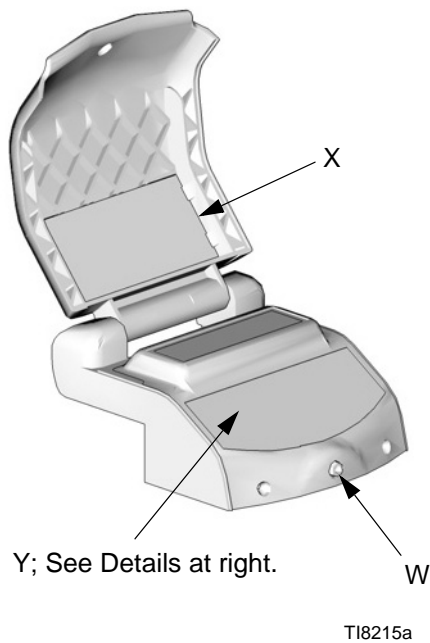



FIG. 3. DataTrak Controls and Indicators



DataTrak Operation

 DataTrak is included with certain models. See page 3 for a list of models featuring DataTrak.

For remote DataTrak models, see your system operation manuals. See pages 39-40 for parts.

 The DataTrak display (Y) will turn off after 1 minute to save battery life. Press any key to wake up the display.

Setup Mode

1. See FIG. 3. Press and hold  for 5 seconds until Setup menu appears.
2. To enter settings for runaway, lower size, and flow rate units, and to enable runaway, E1, E2, and E5 error options, press  to change the value, then  to save the value and move the cursor to the next data field.

 When runaway, E1, E2, and E5 error options are enabled, a ✓ will appear on the setup screen. See FIG. 3.

3. Move the cursor to the E5 error enable option field, then press  once more to exit Setup mode.

Run Mode

Runaway

 The runaway control should be tested regularly. To test, go to Setup Mode and set value to 1 (one). Pump should stop in six cycles.

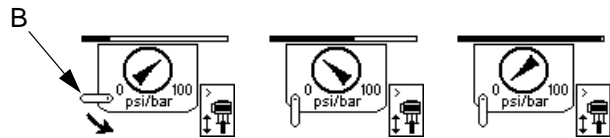

1. See FIG. 3. If pump runaway occurs, the runaway solenoid will actuate, stopping the pump. The LED (W) will flash and the display (Y) will indicate a runaway condition (see Table 1).
2. To reset runaway monitor, close master air valve (B). Wait for air to completely bleed off the air motor before going to step 3. The screen will change to indicate this, as shown below.



3. Press  to clear the diagnostic code and reset the runaway solenoid.



4. Open master air valve (B) to restart pump.

 To disable runaway monitoring, go to setup mode and set runaway value to 0 (zero) or toggle (RT) off  (see FIG. 3).

Prime/Flush

1. See FIG. 3. To enter Prime/Flush mode, press any key to wake up the display, then press . The Prime/Flush symbol will appear in the display and

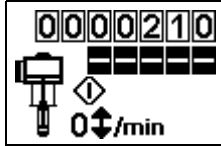

the LED will flash



2. While in Prime/Flush mode, runaway protection is disabled and the batch totalizer (BT) will not count.
3. To exit Prime/Flush mode, press any key to wake up the display, then press . The Prime/Flush symbol will disappear from the display and the LED will stop flashing.

Counter/Totalizer

See FIG. 3. The last digit of the batch totalizer (BT) represents tenths of gallons or liters. To reset the totalizer, press any key to wake up the display, then press and hold  for 3 seconds.

 If flow rate is set to  /min, both totalizers will display the number of pump cycles.

Display

See FIG. 3. The display (Y) will turn off after 1 minute of inactivity in Run mode or 3 minutes in Setup mode. Press any key to wake up the display.

 DataTrak will continue to count cycles when display is off.

Diagnostics

DataTrak can diagnose several problems with the pump. When the monitor detects a problem, the LED (W, FIG. 3) will flash and a diagnostic code will appear on the display. See Table 1.









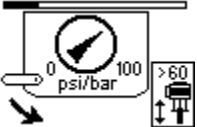

To acknowledge the diagnosis and return to the normal operating screen, press   once to wake up the display, and once more to clear the diagnostic code screen.

Table 1: Diagnostic Codes

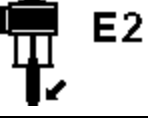
Symbol	Code No.	Code Name	Diagnosis	Cause
		Runaway	Pump running faster than set runaway limit.	<ul style="list-style-type: none"> Increased air pressure. Increased fluid output. Exhausted fluid supply.
	E-1	Diving Up	Leak during upstroke.	Worn piston valve or packings.
	E-2	Diving Down	Leak during downstroke.	Worn intake valve.
	E-3	Low Battery	Battery voltage too low to stop runaway.	<ul style="list-style-type: none"> Low battery. To replace battery, see page 15. Disable Runaway mode until battery is replaced; see page 12.
	E-4	Service Component 1	Problem with stopping runaway.	<ul style="list-style-type: none"> Damaged solenoid. Damaged valve carriage.
	E-4	Disconnected Solenoid	Solenoid is disconnected.	<ul style="list-style-type: none"> Solenoid unplugged. Damaged solenoid wires.
	E-5	Service Component 2	Problem with sensing valve movement.	<ul style="list-style-type: none"> Sensors unplugged. Sensors mounted incorrectly. Damaged sensors. Damaged valve carriage.
	E-6	Blown Fuse	Fuse is blown.	<ul style="list-style-type: none"> Faulty solenoid or solenoid wiring. Extreme temperatures (above 140°F [60°C]). Disable Runaway mode until fault is corrected and fuse is replaced. See pages 12 and 15.

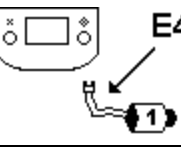
Replace the DataTrak Module Battery or Fuse

						
---	---	--	--	--	--	--

To reduce the risk of fire and explosion, the battery and fuse must be replaced in a non-hazardous location.

Use only an approved replacement battery, shown in Table 2, and an approved fuse, shown in Table 3. Use of an unapproved battery or fuse will void Graco's warranty and Intertek and Ex approvals.

1. Remove two screws (135). Carefully slide the DataTrak module (131) out of the housing (132). See FIG. 4.

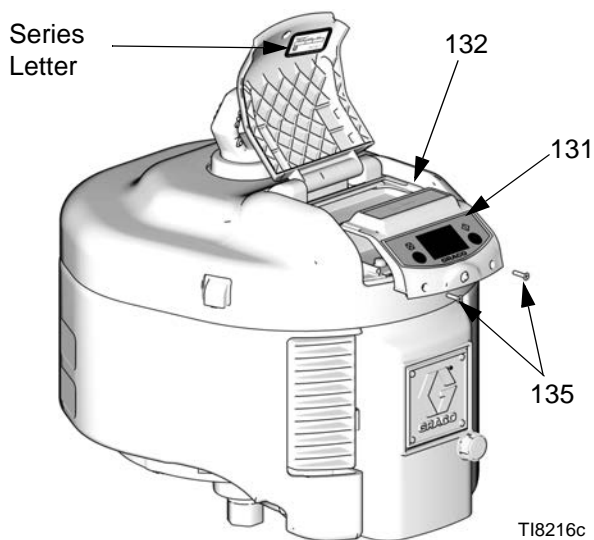



FIG. 4. Remove DataTrak Module

2. Disconnect the runaway solenoid and sensor cables from the module board. See FIG. 5.
3. Take the DataTrak module (131) to a non-hazardous location.

4. **To replace the battery**, disconnect the used battery and replace with an approved battery.

						
---	--	--	--	--	--	--

Use only a Graco-approved replacement fuse (131a).

Table 2: Approved Batteries

Energizer alkaline # 522
Varta alkaline # 4922
Ultralife lithium # U9VL
Duracell alkaline # MN1604

5. **To replace the fuse (131a):**

- a. Remove the screw, metal strap, and plastic holder.
- b. Pull the fuse away from the board.
- c. Replace with a new fuse (131a).

Table 3: Approved Fuses

Series*	Fuse Required
A	NXT413
B and later	24V216

* FIG. 4 shows where to find the Series letter.

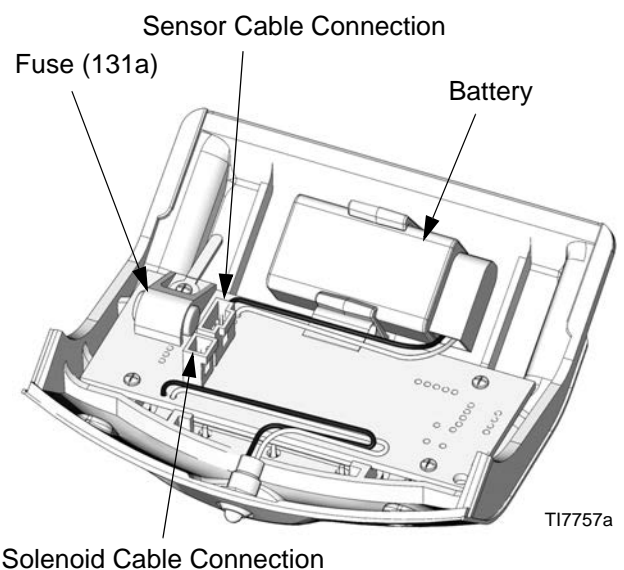



FIG. 5. DataTrak Battery and Fuse Location

Troubleshooting

 Also see the troubleshooting section in the Integrated Air Control Modules manual 311239.



 To find parts lists for the parts identified in the troubleshooting tables, see page numbers listed in the table below.

Air Motor Model	Parts List Page
NXT Model 2200	33
NXT Model 3400	35
NXT Model 6500	37

LED is flashing

See TABLE 1: Diagnostic Codes, page 14.

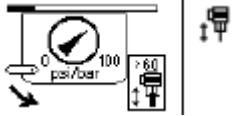
Air Motor will not run with DataTrak

Symptom	Cause	Check Procedure	Solution
Runaway error code displayed, pump running faster than set runaway limit. 	Exhausted fluid supply, increased air pressure, increase fluid output, set point too low.	Verify input air pressure, fluid supply, fluid output, and runaway set point.	Verify air pressure has been removed, wait 30 seconds then press reset. See Runaway on page 12, manual. Press  to clear the diagnostic code and reset the runaway solenoid. 
Runaway error code does not clear.	Solenoid pin will not retract.	Remove outer valve cover (47-287844) and solenoid (140-NXT403) to see if pin is fully retracted.	Replace solenoid (140-NXT403).

Air Motor will not run all models

Symptom	Cause	Check Procedure	Solution
Motor stuck at top or bottom stroke of piston.	Air pressure is set below 20 psi (140 kpa, 1.4 bar).	Increase air pressure to 20 psi (140 kpa, 1.4 bar) or greater.	Verify air pressure is 20 psi (140 kpa, 1.4 bar) or greater.
	poppet pin seat has debris or is damaged on top poppet valve (12-NXT100).	Reverse the poppet valves (12-NXT100), and see if problem moves to opposite side. Note: Make sure o-ring (12d) and backup ring (12c) do not remain in the end cap casting.	Clean or replace poppet valve (12-NXT100) Note: Problem poppet is typically opposite from where motor stops, because at the last changeover this poppet stuck open, preventing the next changeover.
	Binding/sticking of air valve cup/carriage (108-NXT138). or piston valve (119-NXT142).	Remove air valve cover (112-15G865) and check for binding/sticking of air valve cup/carriage (108-NXT138) or piston valve (119-NXT142) Note: be careful removing Gasket (106-15H634).	Remove air valve cup/carriage (108-NXT138) and/or piston valve (119-NXT142), check for nicks or burrs, grease and reassemble. Replace air valve cup/carriage (108-NXT138) or piston valve (119-NXT142)
	Binding/sticking spring loaded detent (113-NXT137).	Remove air valve cover (112-15G865) and check for binding/sticking of spring loaded detent (113-NXT137) Note: be careful removing Gasket (106-15H634).	Remove air valve cover (112-15G865) and spring loaded detent (113-NXT137). Clean, inspect, grease, and reassemble.
Poppet valve (12-NXT100) or valves leaking constantly though poppet muffler (58-120206) exhaust.	Poppet valve stuck open exhausting air through muffler in mid stroke.	Stall air motor under load in the middle of the stroke, remove top cover (30) and check for leak through #58 poppet muffler (120206) on top cap plate (1-15F955), and/or for leak through poppet muffler (58-120206) in bottom motor cover (3-NXT202).	Remove and clean poppet valve. Note: make sure o-ring (12d) and back-up ring (12c) do not remain in end cap castings prior to re-assembly.
Air blowing out rear main motor exhaust.	Worn or damaged motor piston o-ring (17).	Stall air motor under load in the middle of the stroke, check for air exhausting from rear main motor exhaust.	Replace motor piston o-ring (17). Models: 2200 - 123196 3400- 122434 6500- 122675
	Worn or damaged air valve cup/carriage (108-NXT138).		Remove air valve cover (112-15G865) and check for binding/sticking of air valve cup/carriage (108-NXT138). Note: be careful removing gasket (106-15H634). Replace air valve cup (108-NXT138)
	Damaged valve plate seal (104-15F435).		Replace valve plate seal (104-15F435).

Erratic motor operation

Symptom	Cause	Check Procedure	Solution
Motor runs slow.	Icing. Note: External icing is normal.	Stop spraying for a few minutes to see if motor speed returns to normal.	Reduce pressure, cycle rate, or duty cycle of motor, and/or turn the de-icing control knob (62-NXT112) counter-clockwise to open. Low-Noise motors will ice faster than De-ice models. Convert to de-ice muffler by removing diffuser (63-15G689) and deflector (54-15H179). Add coalescing filter with auto drain (NXT093) if models w/ built in air controls
	In-adequate air supply, line size, and/or reducing QC connections	Verify air supply and line size	Increase air supply, remove any restricting connecting devices Note: air line minimum size of 3/4 in. should be used. See system manual for air consumption data
Slow motor reversal.	Plugged poppet muffler (58-120206) on top cap plate (1), and/or poppet muffler (58-120206) in bottom motor cover (3). Valve assembly is dry and sticky.	Remove poppet mufflers (58) and check for proper changeover.	Replace poppet muffler (58-120206) on top cap plate (1), and/or poppet muffler (58-120206) in bottom motor cover (3-NXT302). Add oil to air filter cup or add an air line oiler.
	Air motor "bounces" at top or bottom of the stroke.	Poppet pin seat has debris or is damaged on top or bottom poppet valve (12-NXT100). Piston valve seal damaged or installed backward on piston valve (119-NXT142). Valve body (103-15H394) is cracked due to screws (123-120089) being over-torqued.	Clean or replace the bottom poppet valve (12-NXT100) Note: Problem poppet is typically opposite from where motor bounces, because the opposite poppet valve is slightly leaking, preventing proper changeover. Replace valve body (103-15H394) or entire air valve assembly (40-120089). Replace valve body (103-15H394) or entire air valve assembly (40-120089).
Motor runs below 10 psi air input pressure Note: 20 psi (140 kpa, 1.4 bar) or greater needed to run NXT air motor.	Missing or damaged spring loaded detent (113-NXT137).	Remove air valve cover (112-15G865) and check for binding/sticking of spring loaded detent (113-NXT137) Note: be careful removing gasket (106-15H634).	Replace spring loaded detent (113-NXT137).
Motor runs only at 50 psi (345 kpa, 3.4 bar) or greater.	Leaking flat gasket (46-253476).	Remove outer valve cover (47-287844) and verify four 3/8 -16 x 4" screws (41-120088), are tight to 20 ft-lbs (27.1 N•m)	Replace flat gaskets (46-253476). Note: apply grease to gasket surface prior to re-assembly.
Motor runs at 20 - 50 psi (140-345 kPa, 1.4-3.4 bar), but stops if input air pressure is 50 psi (345 kpa, 3.4 bar) or greater.	Two bumpers (59-277366) installed below #4 main piston.	Disassemble and inspect	Remove extra bumper (59-277366).

Erratic air pressure with built in air control

Symptom	Cause	Check Procedure	Solution
Built in air inlet gauge reads zero "0".	Lack of air pressure.	Verify air supply is present, main air valve is on, turn "C" regulator knob clockwise to desired set pressure.	Verify air supply is present, main air valve is on, turn "C" regulator knob clockwise to desired set pressure. Note: If regulator knob is locking style, pull out before adjusting.
Air pressure varies 5 - 10 psi from set point.	Pilot valve (17-NXT095) bleed orifice obstructed.		Rebuild with regulator repair kit (17-NXT095).
Air pressure jumps to line input pressure from set point.	Formed gasket (17-15G439) is leaking.		Replace gasket (3-15G439) or seal repair kit (NXT096).
	Sticking/damaged regulator valve spool (8-NXT098).		Remove, inspect for damage, grease and reassemble. replace regulator valve spool (8-NXT098) if damaged.
			Remove air control and install another regulator to 3/4 npt(f) motor air inlet port to see if problem remains with the air motor. Light Duty Kit: 262230 Heavy Duty or Xtreme Duty: 262231

Air continuously exhausting from motor

Symptom	Cause	Check Procedure	Solution
Air continuously exhausting around motor shaft.	Damaged air motor shaft seal.		Replace seals with NXT200 (2200), NXT300 (3400), NXT600 (6500) motor seal kit. See Parts , page 31.
Air continuously exhausting from muffler on up and down strokes.	De-icing control is open.	Check de-icing control knob.	Close de-icing control with knob or flat blade screwdriver.

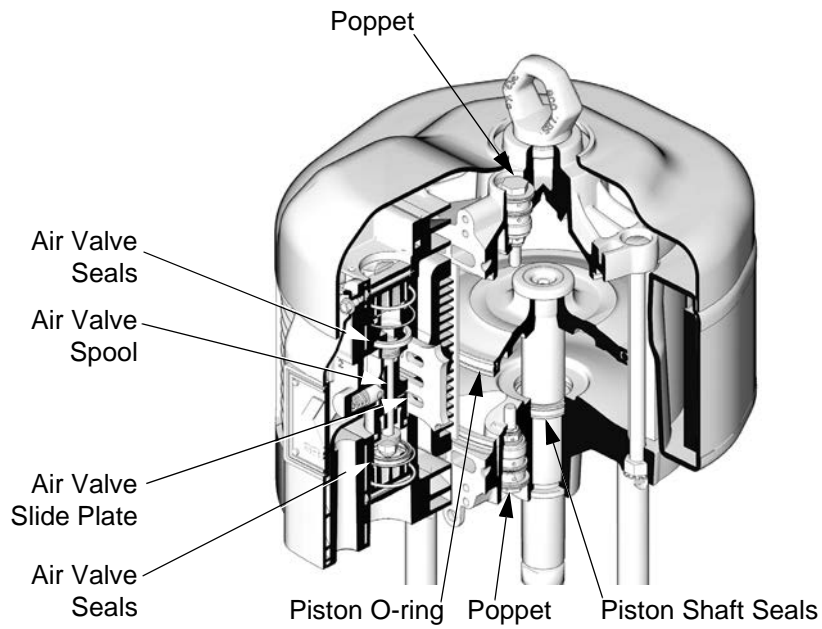

TI8624a

FIG. 6. Cutaway View, Standard and DataTrak Models

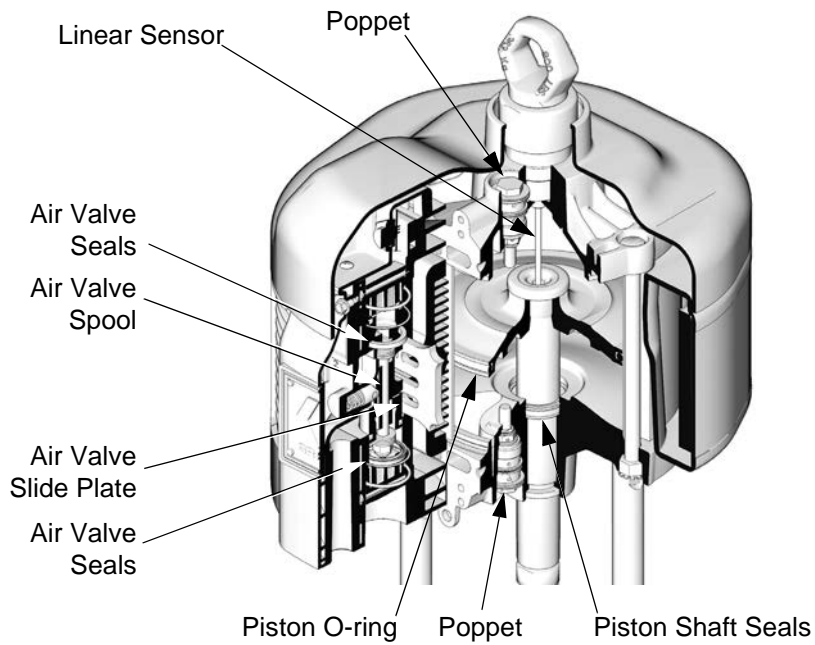

TI8066b

FIG. 7. Cutaway View, Models with Linear Sensor

Repair





Preventive Maintenance Schedule

The operating conditions of your particular system determine how often maintenance is required. Establish a preventive maintenance schedule by recording when and what kind of maintenance is needed, and then determine a regular schedule for checking your system.

Tools Required

- Flat blade screwdriver
- Phillips screwdriver
- 3/4 in. socket wrench
- 9/16 in. socket wrench
- 3/8 in. socket wrench
- Torque wrench
- Grease
- Thread adhesive

Pressure Relief Procedure

							
Trapped air can cause the pump to cycle unexpectedly, which could result in serious injury from skin injection or moving parts.							

							
Do not lift or move motor while pressurized.							

1. Engage the trigger lock.
2. Close the bleed-type master air valve.
3. Disengage the trigger lock.

4. Hold a metal part of the gun firmly to a grounded metal pail. Trigger the gun to relieve pressure.
5. Engage the trigger lock.
6. Open all fluid drain valves in the system, having a waste container ready to catch drainage. Leave drain valve(s) open until you are ready to spray again.
7. If you suspect the spray tip or hose is clogged or that pressure has not been fully relieved after following the steps above, **VERY SLOWLY** loosen tip guard retaining nut or hose end coupling to relieve pressure gradually, then loosen completely. Clear hose or tip obstruction.

Air Valve Repair

Remove the Air Valve

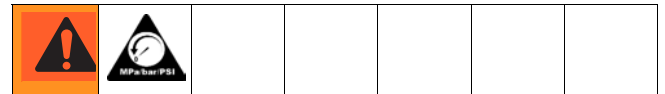

1. Stop the pump at the middle of its stroke. Relieve the pressure, page 21.
2. Disconnect the air line to the motor.
3. See FIG. 8. Pry off the top cover (30).

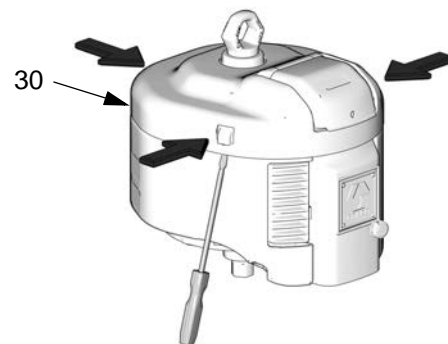





T18218b

FIG. 8. Remove the Top Cover

4. See FIG. 9. Remove the outer valve cover (47).
5. For motors with DataTrak or the linear sensor:

- a. **DataTrak Models:** Remove the two screws (135). Carefully remove the DataTrak module (131), see page 15. Disconnect the runaway solenoid and sensor cables from the module board. Remove the two screws (134) and carefully slide the housing (132) off the air valve.
 - b. **Linear Sensor Models:** Remove the screws (134) and carefully slide the housing (132) off the air valve. Disconnect the sensor cable from the circuit board. See FIG. 15 on page 29.
 - c. **Remote DataTrak Models:** When removing the outer cover (47), carefully slide the remote wire harness and grommet from the slot in the cover. See FIG. 17 on page 30.
6. Remove the screws (43 and 41). Remove the air valve (40) by grasping the top and bottom and rotating the valve out from the right side, to pull the exhaust housing (E) out of the muffler (15). Replace the gaskets (46).
 7. To repair the air valve, go to **Disassemble the Air Valve**, page 23. To install a complete new air valve, continue with step 8.
 8. Lubricate the gaskets (46) and ensure they align with the holes at the back of the air valve (40). Install the air valve. Install the screws (41) and torque to 20 ft-lb (27.1 N•m). Thread the screws (43) in by hand, then fully tighten them against the muffler (15).
 9. For motors with DataTrak or the linear sensor:
 - a. **DataTrak Models:** Carefully slide the housing (132) onto the air valve. Thread the screws (134) in by hand, then torque to 100 in-lb (11.3 N•m). Reattach the solenoid and sensor cables to the DataTrak module (131), see page 15. Carefully slide the module back into the housing (132). Reinstall the two screws (135).
 - b. **Linear Sensor Models:** Reconnect the sensor cable to the circuit board. See FIG. 15, page 29. Carefully slide the housing (132) onto the air valve. Thread the screws (134) in by hand, then torque to 100 in-lb (11.3 N•m).
 - c. **Remote DataTrak Models:** When installing the outer cover (47), carefully slide the remote wire harness and grommet into the slot in the cover. See FIG. 17 on page 30.
 10. Reinstall the top cover (30).
 11. Reconnect the air line to the motor.

-  Apply lubricant.
-  Thread in by hand, then torque to 100 in-lb (11.3 N•m).
-  Torque to 20 ft-lb (27.1 N•m).
-  Fully tighten against muffler (15).

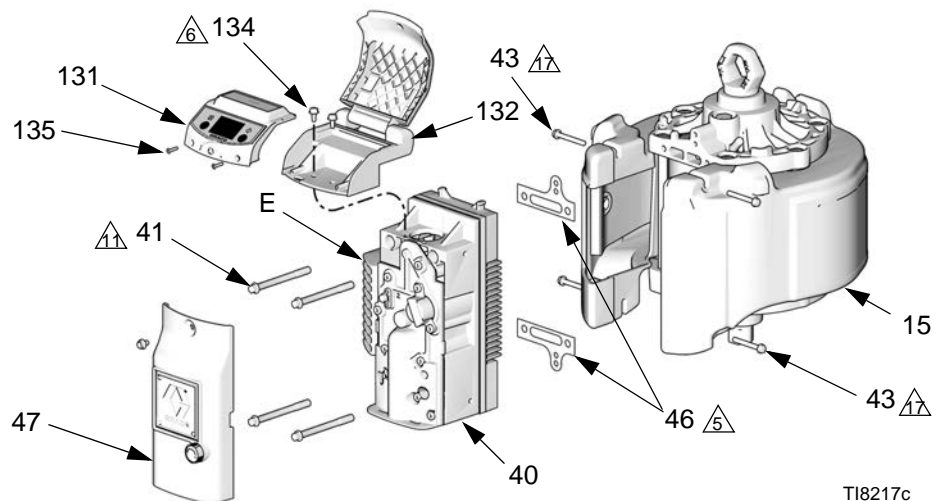

T18217c

FIG. 9. Remove the Air Valve (Model Shown with DataTrak Module)

Disassemble the Air Valve

 Air Valve Seal Repair Kit NXT135 is available. Parts included in the kit are marked with a symbol (†). Kits include the latest part and gasket improvements; use all the parts in the kit.

Air Valve Rebuild Kit NXT144 is available. Parts included in the kit are marked with a symbol (‡). Kits include the latest part and gasket improvements; use all the parts in the kit.

1. Perform steps 1-6 under **Remove the Air Valve**, page 21.
2. See FIG. 11. Remove the screws (124), carriage cover (112), spring-loaded detent (113), gasket (106), and de-icing control (145).
3. See FIG. 10. Remove the retainer pins (111) from their holes (J). Invert the pins and slide the heads into the slots on the piston stops (110). Use the pins to pull the piston stops out.

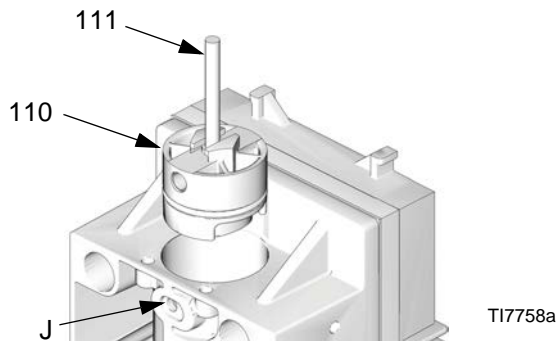

Fig. 10. Remove Piston Stops

4. See FIG. 11. Rotate the piston valve assembly (119) so the pins (P) are accessible. Raise the spring (S) and push one pin out. Push one end of the piston valve out the top of the valve body (103) and the other end out the bottom. Do not permanently distort the springs (S).
5. Inspect the piston and seals. If damaged, replace the piston valve assembly (119). The open seal lip must face to the center.

6. Carefully remove the sleeves (109). Inspect the seals (109a) and the inside surface of the sleeves and housing (103) for wear or damage.
7. Remove the carriage (108) and carriage detent (107).
8. Remove the screws (123), retainers (117), valve plate (105), and seal (104).
9. Inspect the ramp (107), carriage (108), plate (105), body (103), and seal (104) for damage or cracks.

Reassemble the Air Valve

1. Install a new gasket (102†‡) between valve body (103) and exhaust cover (101).
2. Lubricate the valve plate (105‡). Install the seal (104†‡) and plate (105‡) in the valve body (103). Thread the screws (123) and retainers (117) in by hand, then evenly torque to 21-23 ft-lb (28.5-31.1 N•m). Lubricate the sealing face of the carriage (108‡). Install the carriage and ramp (107‡).
3. Lubricate o-rings (109a) on sleeves (109‡). Install the sleeves. Lubricate the inside surfaces.
4. Lubricate pistons and seals of piston valve assembly (119) with lithium grease. Install one end of the piston valve assembly in the valve body (103). Rotate the piston so the pin holes are accessible. Install the other end and secure with the pin (P) and spring (S).

CAUTION

Do not permanently distort the springs. The springs must be completely tight against the piston valve assembly (119) to prevent interference. Ensure the two spring wire ends are not on one side of the clip.

5. Lubricate o-rings (110a). Install the piston stop (110) and retainer pins (111).
6. See FIG. 11. Lubricate and install the spring-loaded detent (113‡), gasket (106‡‡), carriage cover (112), and screws (124). Torque to 130 in-lb (4.7 N•m), following the pattern shown in Inset 11a.

7. See FIG. 9, page 22. Lubricate the gaskets (46) and ensure they align with the holes at the back of the air valve (40). Install the air valve. Install the screws (41) and torque to 20 ft-lb (27.1 N•m). Thread the screws (43) in by hand, then fully tighten them against the muffler (15).
8. For motors with DataTrak or the linear sensor, reinstall the modules, see step 9, page 22.

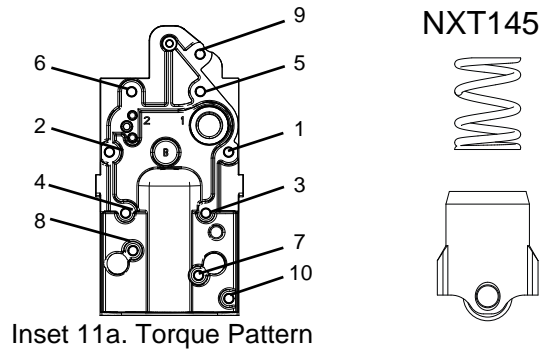

- ⚠1 Apply high quality lithium grease.
- ⚠2 **Important:** Do not permanently distort spring (S). Spring must be completely tight against piston (119) to prevent interference.
- ⚠5 Torque to 130 in-lb (4.7 N•m).
- ⚠7 Thread in by hand, then torque to 21-23 ft-lb (28.5-31.1 N•m).

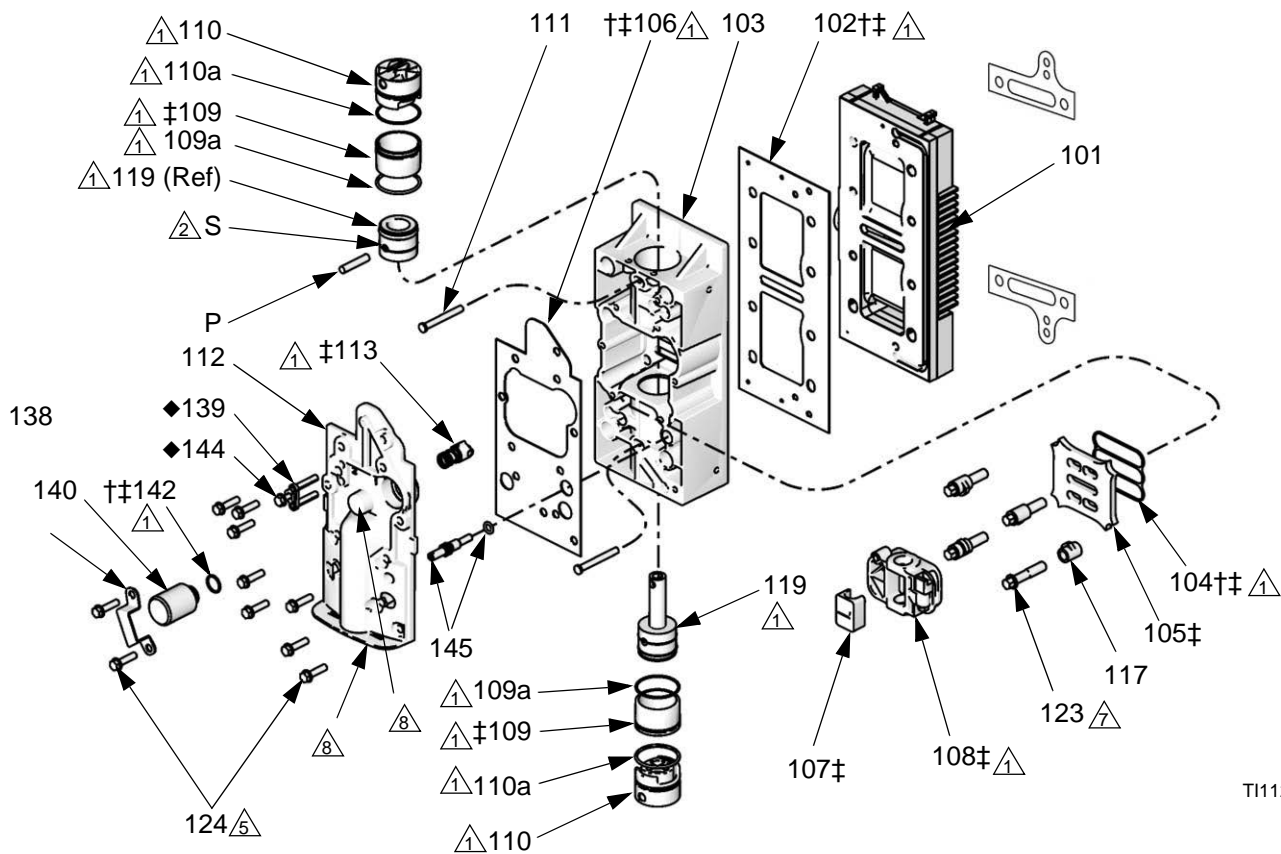

T111295b

FIG. 11. Air Valve Repair (NXT107 Shown)

Cylinder and Piston Repair

 Air Motor Seal Repair Kits are available. See the parts lists on pages 33, 35, and 37 for the correct kit for your size motor. Parts included in the kits are marked with an asterisk (*). For the best results, use all the parts in the kit.

Disassemble the Air Motor



1. Stop the pump at the middle of its stroke. Relieve the pressure, page 21.
2. Disconnect the air line to the motor.
3. See FIG. 8 on page 21. Pry off the top cover (30).
4. For motors with DataTrak or the linear sensor:
 - a. **DataTrak Models:** Remove the two screws (135). Carefully remove the DataTrak module (131), see page 15. Disconnect the runaway solenoid and sensor cables from the module board. Remove the two screws (134) and carefully slide the housing (132) off the air valve.
 - b. **Linear Sensor Models:** Remove the screws (134) and carefully slide the housing (132) off the air valve. Disconnect the sensor cable from the circuit board. See FIG. 15 on page 29.
5. Remove the outer valve cover (47). See FIG. 12.
6. Remove the four screws (43) and the muffler (15).
7. Remove the top two air valve screws (41). Loosen but do not remove the bottom two screws (41). Tilt the air valve (40) to make disassembly easier.
8. Remove the tie bolts (13). Using a rubber mallet, hit the underside of the top cap (1) to separate. Lift the top cap off the motor.
9. Disconnect the air motor from the lower (see your separate pump manual). Leave the piston shaft adapter (A) attached to the shaft (S).
10. Push the piston assembly (4) out the top of the cylinder (2).
11. Inspect the piston o-ring (17). Check the piston (4) and piston shaft (S) for scoring or damage. The replacement piston (4) includes the piston, shaft (S), adapter (A), and bumper (10).
12. Remove the cylinder (2). Check the inner surface for scoring or other damage. Replace if damaged.
13. Remove the bumper (59), retaining ring (9), backup packings (8), and v-packing (7) from the bottom cover (3). Inspect these parts for wear or damage. Inspect the bearing (B) in place (slight scoring is acceptable). If the bearing is damaged, replace the bottom cover (3).

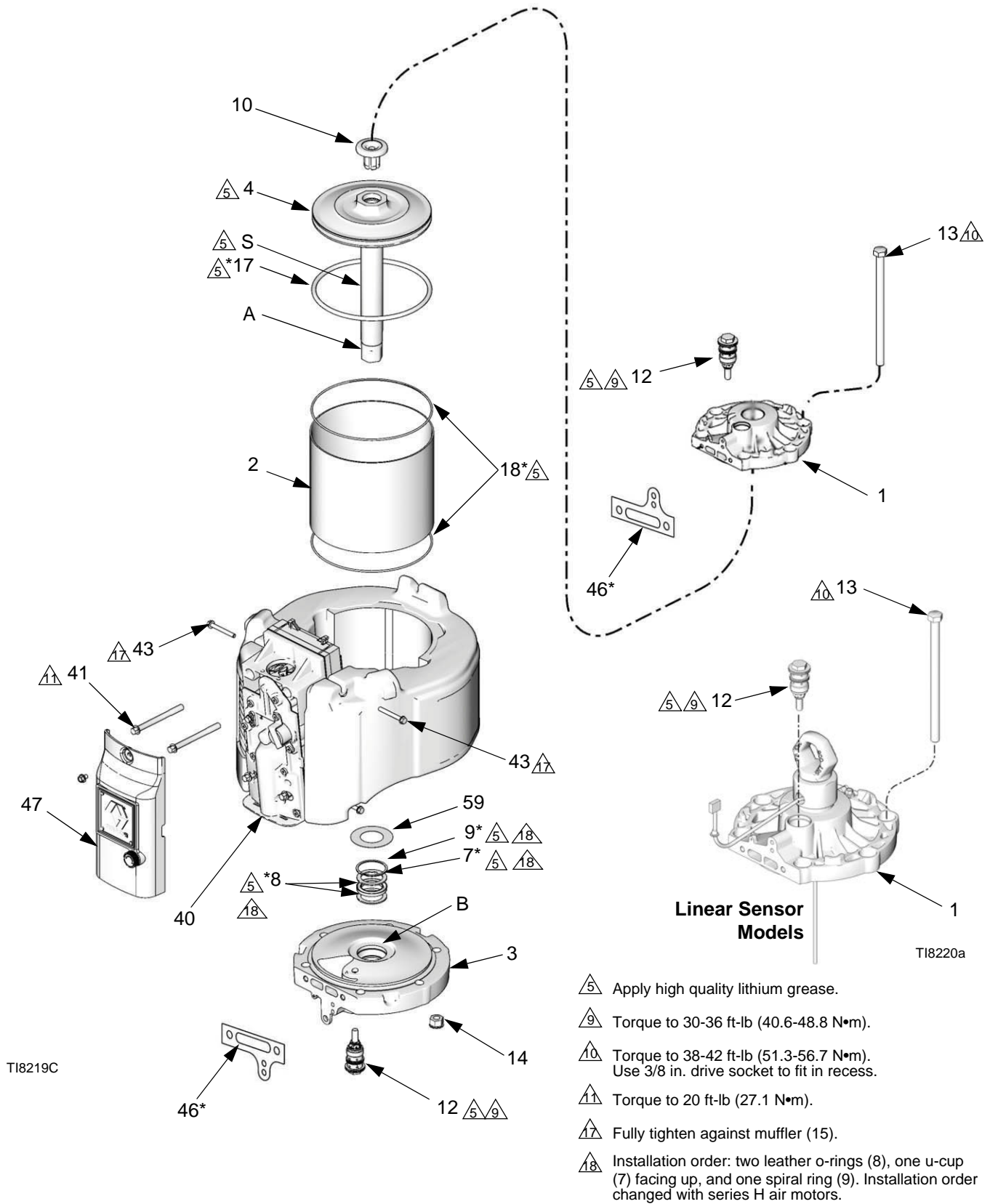

FIG. 12. Air Motor Repair

Reassemble Air Motor

1. See FIG. 12. Install two backup packings (8*), and then v-packing (7*) with the lips facing up. Then install the retaining ring (9*) in the bottom cover (3). Lubricate the packings. Install the bumper (59).



Prior to series H air motors the u-cup (7) was installed between the leather packings (8).

2. Install the o-ring (17*) on the piston (4). Ensure the piston bumper (10) is in place.



It is normal for the o-ring (17*) to seem too large.

3. Install the piston assembly on the bottom cover (3), carefully sliding the adapter (A) and shaft (S) through the packings.
4. Grease the inside of the cylinder (2). Place the cylinder (2) over the piston (4). Be careful not to damage the o-ring (17*). Slowly work the o-ring into the groove, compressing it until the cylinder slides over.



It is normal for the o-ring (17*) to seem too large to fit into the cylinder.

5. Carefully place the top cap on the cylinder (2) so the flat edge aligns with the flat edge of the bottom cover (3). Install the tie bolts (13) hand tight.
6. Using new gaskets (46), reinstall the valve assembly with the top two air valve screws (41) and torque to 20 ft-lb (27.1 N•m). Install the bottom two air valve screws (41) tight to align the end caps (1) and bottom cover (3). Then loosen the two bottom screws (41).
7. Torque end cap tie bolts (13) evenly to 38-42 ft-lb (51.3-56.7 N•m).
8. Retighten the bottom two air valve screws (41) and torque to 20 ft-lb (27.1 N•m).
9. Reconnect the air motor to the lower (see your separate pump manual).



See **Accessories**, page 43, for a list of available adapters to connect the NXT motor to various Graco lowers.

10. Reinstall the muffler (15). Fully tighten the screws (43) against the muffler.
11. Reinstall the outer valve cover (47).
12. For motors with DataTrak or the linear sensor:
 - a. **DataTrak Models:** Carefully slide the housing (132) onto the air valve. Thread the screws (134) in by hand, then torque to 100 in-lb (11.3 N•m). Reattach the solenoid and sensor cables to the DataTrak module (131), see page 15. Carefully slide the module back into the housing (132). Reinstall the two screws (135).
 - b. **Linear Sensor Models:** Reconnect the sensor cable to the circuit board. See FIG. 15, page 29. Carefully slide the housing (132) onto the air valve. Thread the screws (134) in by hand, then torque to 100 in-lb (11.3 N•m).
13. Reinstall the top cover (30).
14. Reconnect the air line to the motor.

Poppet Repair

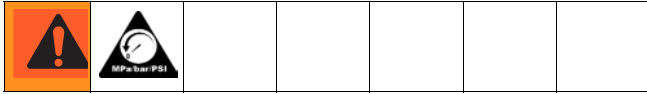

1. Stop the pump at the middle of its stroke. Relieve the pressure, page 10.
2. Disconnect the air line to the motor.
3. See FIG. 8 on page 21. Pry off the top cover (30).
4. See FIG. 13. Unscrew the poppet assemblies (12). The small o-rings (12c, 12d) may not come out with the poppet assemblies. Be sure to remove them from the top cap (1) or bottom cover (3).
5. Inspect the poppet o-rings (12a, 12b, 12d) and backup (12c). Replace damaged o-rings, or replace the entire poppet assembly.
6. Lubricate the poppet assemblies (12) and reinstall in the top cap (1) and bottom cover (3). Torque to 30-36 ft-lb (40.6-48.8 N•m).

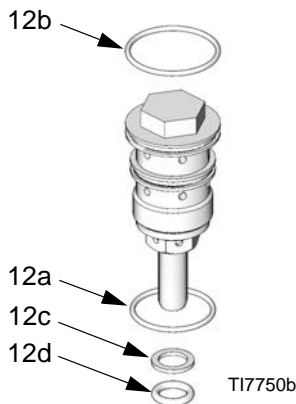



FIG. 13. Original Poppet Detail

 Poppets were upgraded in mid-2009 for improved sealing and earlier actuation. New style poppets can be used in older air motors, but do not use the back-up o-ring (12c).

If you order a replacement poppet NXT100, you will automatically receive a new style poppet.

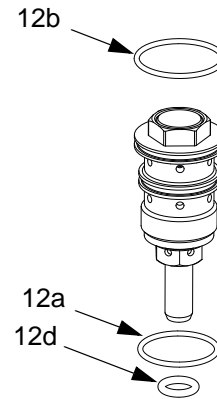
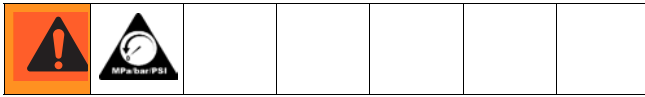

FIG. 14. New Style Poppet Detail

Replace the Linear Sensor (if present)



1. Stop the pump at the middle of its stroke. Relieve the pressure, page 10.
2. Disconnect the air line to the motor.
3. See FIG. 8 on page 21. Pry off the top cover (30).
4. Hold the adapter (33) with a wrench to keep it from turning, and unscrew the lift ring (21). See FIG. 16.
5. Remove the screws (134) and carefully slide the housing (132) off the air valve. Disconnect the sensor cable from the circuit board. See FIG. 15.

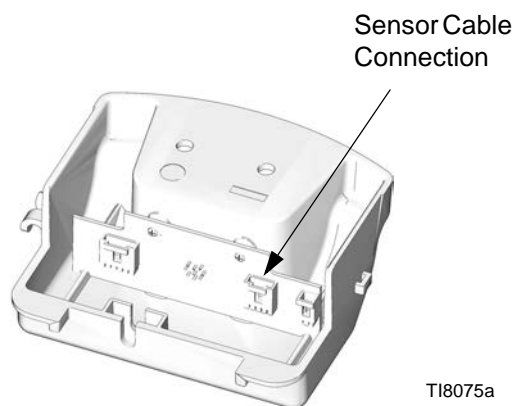

FIG. 15. Sensor Cable Connection

6. Thread the cable back through the hole (H) in the side of the adapter (33) and extend it out the top of the adapter.
7. Unscrew the adapter (33) and sensor (35). Lift the sensor straight up out of the air motor.
8. Apply thread adhesive to the new sensor housing. Screw the sensor (35) into the top cap (1). Torque to 30-36 ft-lb (40.6-48.8 N•m).
9. Apply thread adhesive to the adapter (33). Extend the sensor cable straight up out the top of the adapter, then screw the adapter into the top cap (1). Torque to 30-36 ft-lb (40.6-48.8 N•m).

10. Thread the sensor cable through the hole (H) in the side of the adapter, and reconnect it to the circuit board. See FIG. 15, page 29. Carefully slide the housing (132) onto the air valve. Thread the screws (134) in by hand, then torque to 100 in-lb (11.3 N•m).
11. Apply thread adhesive to the lift ring (21). Hold the adapter (33) with a wrench to keep it from turning, and torque the lift ring to 30-36 ft-lb (40.6-48.8 N•m).
12. Reinstall the top cover (30).
13. Reconnect the air line to the motor.

- Thread in by hand, then torque to 100 in-lb (11.3 N•m).
- Apply adhesive.
- Torque to 30-36 ft-lb (40.6-48.8 N•m).

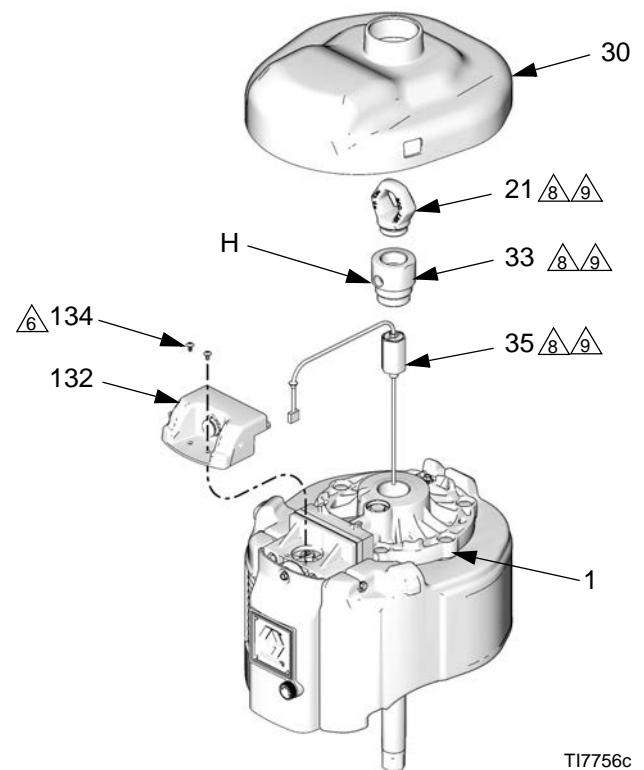
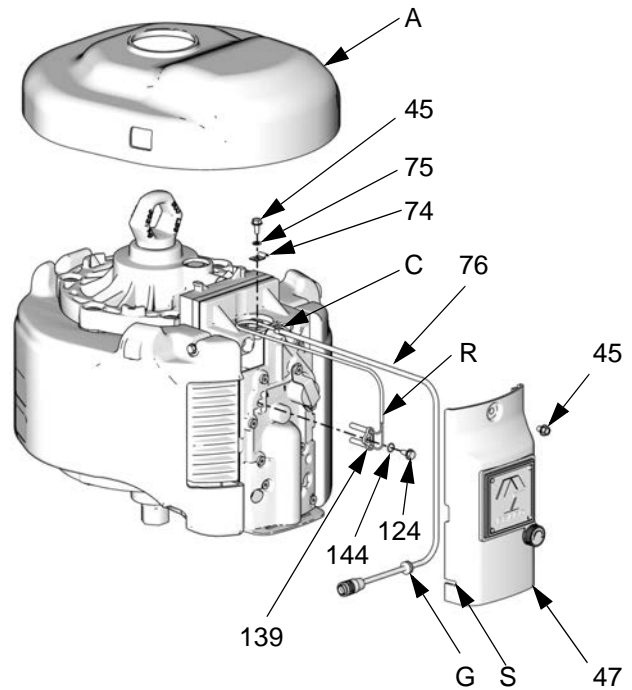

FIG. 16. Replace the Linear Sensor

Remote DataTrak Connection Kit NXT406

1. Stop the pump during the upstroke. Follow the **Pressure Relief Procedure**, page 21.
2. Disconnect the air line to the motor.
3. Pry off the top cover. Remove the air valve cover and discard.
4. Install the reed switch sensor (139) and secure with the screw (124) and o-ring (144). See FIG. 17. Connect the reed switch sensor cable (R) to the remote DataTrak wire harness (76).
5. Route the wires to the top of the air valve. Install the wire strain relief (74) with screw (45) and washer (75) onto the reed switch sensor about 2 in. (50 mm) behind the connection (C).
6. Route the remote DataTrak wire harness (76) down the front of the air valve and carefully slide the grommet (G) into the slot (S) of the new air valve cover (47). There should be about 3 in. (76 mm) of wire extending out of the air valve cover.
7. Install the new air valve cover (47) with the screw (45), positioning the wire harness (76) so it will not be pinched.
8. Reinstall the top cover (A).
9. Reconnect the air line to the motor.
10. Plug the cable from the remote DataTrak module into the wire harness (76).



T110949A

Fig. 17. Remote DataTrak Connection Kit

 See your system operation manuals for complete remote DataTrak instructions.

Air Motor Parts Drawing (Shown with Linear Sensor)

Air Motor Model	Parts List Page
NXT Model 2200	33
NXT Model 3400	35
NXT Model 6500	37

Low Noise Exhaust (24) Detail

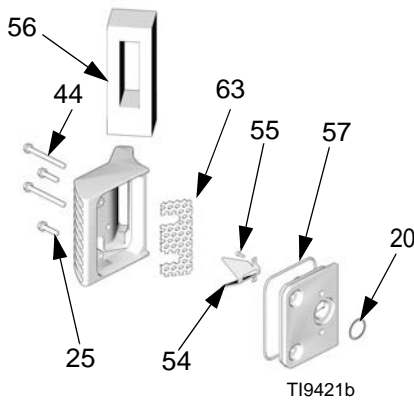

De-Ice Exhaust (22) Detail

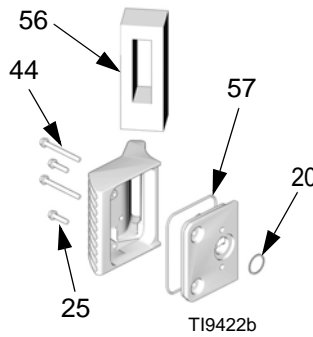

Remote Exhaust (23) Detail

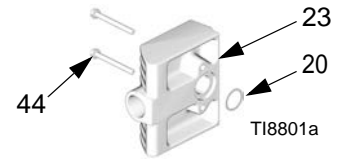

Packing Order Detail

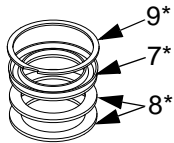

Poppet (12) Detail
(see page 28)

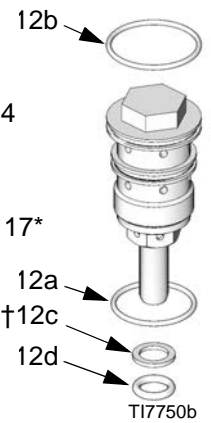

See Exhaust Details Above

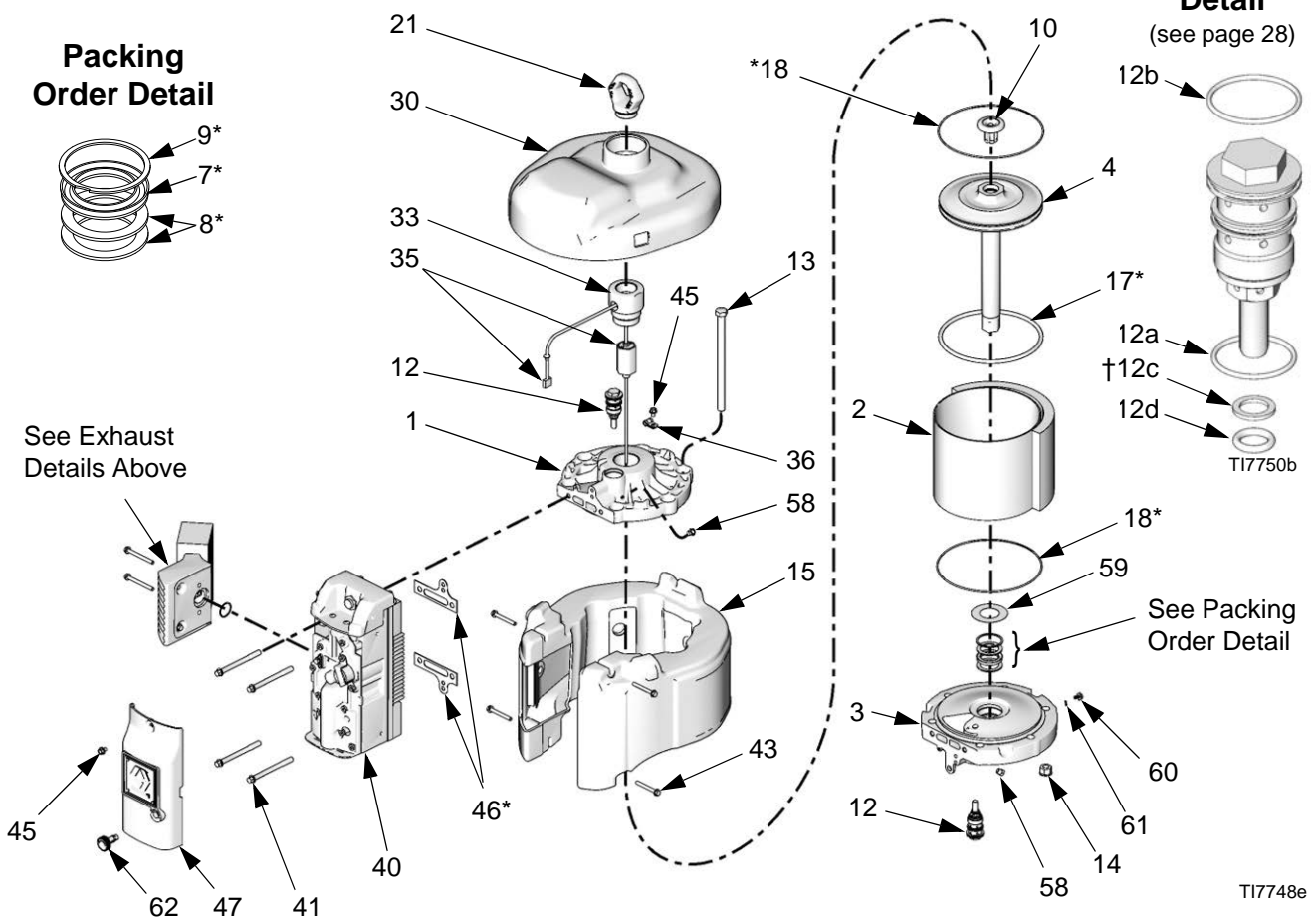

NXT Model 2200 Air Motors

NXT Model 2200 Common Parts

Ref.	Part	Description	Qty	Ref.	Part	Description	Qty
				14	15F639	NUT, with lockwasher; 1/2-13	4
				15	NXT203	MUFFLER	1
1	15F955	COVER, top	1	17*	123196	O-RING, piston; nitrile	1
2	NXT204	CYLINDER	1	18*	15F449	O-RING, end cap; nitrile	2
3	NXT202	COVER, bottom	1	20★	119990	O-RING; buna-N	1
4	NXT201	PISTON ASSEMBLY	1	21	15F931	RING, lift	1
7*	161562	PACKING, V-block; nitrile	1	41	120088	SCREW; 3/8-16 x 4 in. (101 mm)	4
8*	15H610	PACKING, backup; leather	2	43	120091	SCREW, thread forming; 1/4-20 x 2	4
9*	16A026	RING, retaining	1			in. (51 mm)	
10	NXT106	BUMPER, piston; includes magnet	1	44	120092	SCREW, thread forming; 1/4-20 x	2
12	NXT100	POPPET; includes items 12a-12d	2			2-1/2 in. (63 mm)	
12a		. O-RING; buna-N	1	46*	253476	GASKET	1
12b		. O-RING; buna-N	1	47	287844	COVER, valve, outer	1
12c†	NXT101	. O-RING, backup; buna-N	1	51▲	15F674	LABEL, safety	1
12d		. O-RING; buna-N	1	52▲	15F973	LABEL, safety	1
13	119050	BOLT, hex hd; 1/2-13 x 8 in. (203 mm)	4	58	120206	MUFFLER, poppet	2
				59	277366	BUMPER	1
				60	116343	SCREW, ground; M5 x 0.8	1
				61	111307	WASHER, lock; 5 mm	1
				62	NXT112	KNOB, de-ice	1

NXT Model 2200 Varying Parts

Ref.	Description	Air Motor Part Numbers									Qty
		N22DN0	N22DT0	N22DH0	N22LN0	N22LT0	N22LH0	N22RN0	N22RT0	N22RH0	
22	KIT, de-ice exhaust; includes items 20, 25, 44, 56, 57	NXT110	NXT110	NXT110							1
23	KIT, remote exhaust; includes items 20, 44							NXT105	NXT105	NXT105	1
24	KIT, low noise exhaust; includes items 20, 22, 25, 44, 54, 55, 56, 57, 63				NXT104	NXT104	NXT104				1
25	SCREW, machine, hex hd; 1/4-20 x 1 in. (25 mm)	120730	120730	120730	120730	120730	120730				2
30	COVER, top	15G377	15G576	15G379	15G377	15G576	15G379	15G377	15G576	15G379	1
33	ADAPTER, lift ring			15F772			15F772			15F772	1
35	SENSOR ASSEMBLY			287839			287839			287839	1
36	GUIDE, strain relief			120143			120143			120143	1
40	AIR VALVE ASSEMBLY; see page 40	NXT107	NXT108	NXT109	NXT107	NXT108	NXT109	NXT107	NXT108	NXT109	1
45	SCREW, thread-forming; 1/4-20 x 1/2 in. (13 mm)	107257			107257			107257			1
			107257			107257			107257		3
				107257			107257			107257	4
54★	DEFLECTOR				15H179	15H179	15H179				1
55★	SCREW, thread-forming; 1/4-20 x 1/2 in. (13 mm)				107257	107257	107257				2
56	SEAL, exhaust	15H190	15H190	15H190	15H190	15H190	15H190				1
57★	GASKET; buna-N	15K345	15K345	15K345	15K345	15K345	15K345				1
63★	DIFFUSER, exhaust				15G689	15G689	15G689				1
64	O-RING	108014	108014		108014	108014		108014	108014		1
65	ADAPTER, lift ring	16D001	16D001		16D001	16D001		16D001	16D001		1
66	O-RING	C20987	C20987		C20987	C20987		C20987	C20987		1

▲ Replacement Danger and Warning labels, tags, and cards are available at no cost.

* Parts included in Repair Kit NXT200 (purchase separately).

★ Parts included in Low Noise Exhaust Conversion Kit NXT111 (purchase separately).

† Only used on original poppets (see FIG. 13) made prior to mid-2009.

NXT Model 3400 Air Motors

NXT Model 3400 Common Parts

Ref.	Part	Description	Qty	Ref.	Part	Description	Qty
				14	15F639	NUT, with lockwasher; 1/2-13	6
				15	NXT303	MUFFLER	1
1	15F954	COVER, top	1	17*	122434	O-RING, piston; nitrile	1
2	NXT304	CYLINDER	1	18*	15F449	O-RING, end cap; nitrile	2
3	NXT302	COVER, bottom	1	20★	119990	O-RING; buna-N	1
4	NXT301	PISTON ASSEMBLY	1	21	15F931	RING, lift	1
7*	161562	PACKING, V-block; nitrile	1	41	120088	SCREW; 3/8-16 x 4 in. (101 mm)	4
8*	15H610	PACKING, backup; leather	2	43	120091	SCREW, thread forming; 1/4-20 x 2	4
9*	16A026	RING, retaining	1			in. (51 mm)	
10	NXT106	BUMPER, piston; includes magnet	1	44	120092	SCREW, thread forming; 1/4-20 x	2
12	NXT100	POPPET; includes items 12a-12d	2			2-1/2 in. (63 mm)	
12a		. O-RING; buna-N	1	46*	253476	GASKET	1
12b		. O-RING; buna-N	1	47	287844	COVER, valve, outer	1
12c†	NXT101	. O-RING, backup; buna-N	1	51▲	15F674	LABEL, safety	1
12d		. O-RING; buna-N	1	52▲	15F973	LABEL, safety	1
13	119050	BOLT, hex hd; 1/2-13 x 8 in. (203 mm)	6	58	120206	MUFFLER, poppet	2
				59	277366	BUMPER	1
				60	116343	SCREW, ground; M5 x 0.8	1
				61	111307	WASHER, lock; 5 mm	1
				62	NXT112	KNOB, de-ice	1

NXT Model 3400 Varying Parts

Ref.	Description	Air Motor Part Numbers									Qty
		N34DN0	N34DT0	N34DH0	N34LN0 N34LN2	N34LT0	N34LH0	N34RN0	N34RT0	N34RH0	
22	KIT, de-ice exhaust; includes items 20, 25, 44, 56, 57	NXT110	NXT110	NXT110							1
23	KIT, remote exhaust; includes items 20, 44							NXT105	NXT105	NXT105	1
24	KIT, low noise exhaust; includes items 20, 22, 25, 44, 54, 55, 56, 57				NXT104	NXT104	NXT104				1
25	SCREW, machine, hex hd; 1/4-20 x 1 in. (25 mm)	120730	120730	120730	120730	120730	120730				2
30	COVER, top	15G556	15G575	15G558	15G556	15G575	15G558	15G556	15G575	15G558	1
33	ADAPTER, lift ring			15F772			15F772			15F772	1
35	SENSOR ASSEMBLY			287839			287839			287839	1
36	GUIDE, strain relief			120143			120143			120143	1
40	AIR VALVE ASSEMBLY; see page 40	NXT107	NXT108	NXT109	NXT107	NXT108	NXT109	NXT107	NXT108	NXT109	1
45	SCREW, thread-forming; 1/4-20 x 1/2 in. (13 mm)	107257			107257			107257			1
			107257			107257			107257		3
				107257			107257			107257	4
54★	DEFLECTOR				15H179	15H179	15H179				1
55★	SCREW, thread-forming; 1/4-20 x 1/2 in. (13 mm)				107257	107257	107257				2
56	SEAL, exhaust	15H190	15H190	15H190	15H190	15H190	15H190				1
57★	GASKET; buna-N	15K345	15K345	15K345	15K345	15K345	15K345				1
63★	DIFFUSER, exhaust				15G689	15G689	15G689				1
64	O-RING	108014	108014		108014	108014		108014	108014		1
65	ADAPTER, lift ring	16D001	16D001		16D001	16D001		16D001	16D001		1
66	O-RING	C20987	C20987		C20987	C20987		C20987	C20987		1

▲ Replacement Danger and Warning labels, tags, and cards are available at no cost.

* Parts included in Repair Kit NXT300 (purchase separately).

★ Parts included in Low Noise Exhaust Conversion Kit NXT111 (purchase separately).

† Only used on original poppets (see FIG. 13) made prior to mid-2009.

NXT Model 6500 Air Motors

NXT Model 6500 Common Parts

Ref.	Part	Description	Qty	Ref.	Part	Description	Qty
1	15F953	COVER, top	1	14	15F639	NUT, with lockwasher; 1/2-13	6
2	NXT604	CYLINDER	1	15	NXT603	MUFFLER	1
3	NXT602	COVER, bottom	1	17*	122675	O-RING, piston; nitrile	1
4	NXT601	PISTON ASSEMBLY	1	18*	15F448	O-RING, end cap; nitrile	2
7*	161562	PACKING, V-block; nitrile	1	20★	119990	O-RING; buna-N	1
8*	15H610	PACKING, backup; leather	2	21	15F931	RING, lift	1
9*	16A026	RING, retaining	1	41	120088	SCREW; 3/8-16 x 4 in. (101 mm)	4
10	NXT106	BUMPER, piston; includes magnet	1	43	120091	SCREW, thread forming; 1/4-20 x 2 in. (51 mm)	4
12	NXT100	POPPET; includes items 12a-12d	2	44	120092	SCREW, thread forming; 1/4-20 x 2-1/2 in. (63 mm)	2
12a		. O-RING; buna-N	1	46*	253476	GASKET	1
12b		. O-RING; buna-N	1	47	287844	COVER, valve, outer	1
12c†	NXT101	. O-RING, backup; buna-N	1	51▲	15F674	LABEL, safety	1
12d		. O-RING; buna-N	1	52▲	15F973	LABEL, safety	1
13	119050	BOLT, hex hd; 1/2-13 x 8 in. (203 mm)	6	58	120206	MUFFLER, poppet	2
				59	277366	BUMPER	1
				60	116343	SCREW, ground; M5 x 0.8	1
				61	111307	WASHER, lock; 5 mm	1
				62	NXT112	KNOB, de-ice	1

NXT Model 6500 Varying Parts

Ref.	Description	Air Motor Part Numbers										Qty
		N65DN0	N65DT0	N65DH0	N65LN0 N65LN2	N65LT0	N65LH0	N65RN0	N65RT0	N65RH0	257055	
22	KIT, de-ice exhaust, includes items 20, 25, 44, 56, 57	NXT110	NXT110	NXT110							NXT110	1
23	KIT, remote exhaust; includes items 20, 44							NXT105	NXT105	NXT105		1
24	KIT, low noise exhaust; includes items 20, 22, 25, 44, 54, 55, 56, 57				NXT104	NXT104	NXT104					1
25	SCREW, machine, hex hd; 1/4-20 x 1 in. (25 mm)	120730	120730	120730	120730	120730	120730				120730	2
30	COVER, top	16R866	16R868	15F880	16R866	16R868	15F880	16R866	16R868	15F880	15F880	1
33	ADAPTER, lift ring			15F772			15F772			15F772	15F772	1
35	SENSOR ASSEMBLY			287839			287839			287839	256893	1
36	GUIDE, strain relief			120143			120143			120143	120143	1
40	AIR VALVE ASSEMBLY; see page 40	NXT107	NXT108	NXT109	NXT107	NXT108	NXT109	NXT107	NXT108	NXT109	NXT109	1
45	SCREW, thread-forming; 1/4-20 x 1/2 in. (13 mm)	107257			107257			107257				1
			107257			107257			107257			3
				107257			107257			107257	107257	4
54★	DEFLECTOR				15H179	15H179	15H179					1
55★	SCREW, thread-forming; 1/4-20 x 1/2 in. (13 mm)				107257	107257	107257					2
56	SEAL, exhaust	15H190	15H190	15H190	15H190	15H190	15H190				15H190	1
57★	GASKET; buna-N	15K345	15K345	15K345	15K345	15K345	15K345				15K345	1
63★	DIFFUSER, exhaust				15G689	15G689	15G689					1
64	O-RING	108014	108014		108014	108014		108014	108014			1
65	ADAPTER, lift ring	16D001	16D001		16D001	16D001		16D001	16D001			1
66	O-RING	C20987	C20987		C20987	C20987		C20987	C20987			1

▲ Replacement Danger and Warning labels, tags, and cards are available at no cost.

* Parts included in Repair Kit NXT600 (purchase separately).

★ Parts included in Low Noise Exhaust Conversion Kit NXT111 (purchase separately).

† Only used on original poppets (see FIG. 13) made prior to mid-2009.

Air Motor Parts Drawing (for use with Remote DataTrak)

Air Motor Models
N22LR0
N34LR0
N65LR0

Low Noise Exhaust (24) Detail

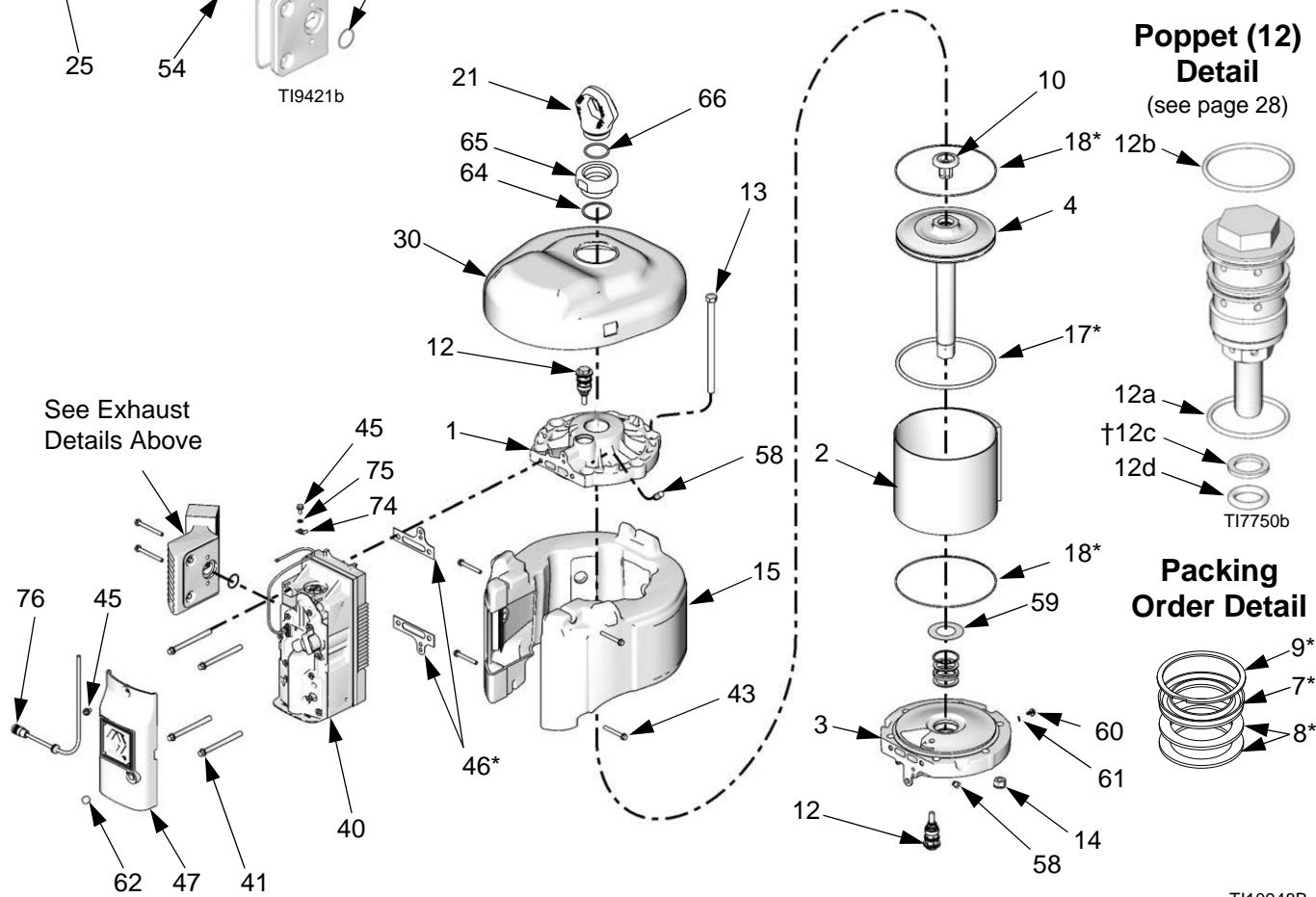
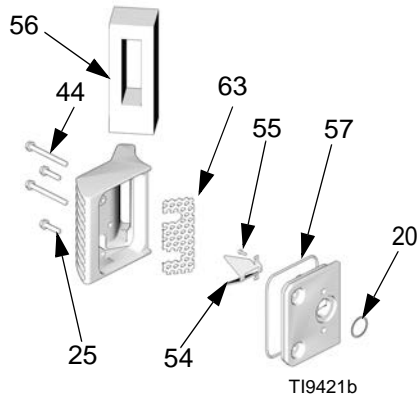

See Exhaust Details Above

Poppet (12) Detail
(see page 28)

Packing Order Detail

TI10948B

Air Motor Parts List (for use with Remote DataTrak)

Air Motor Models
N22LR0
N34LR0
N65LR0

The parts listed below are common to all NXT Model Air Motors using the remote DataTrak. Parts which vary by air motor are found in the table at the bottom of this page.

Ref.	Part	Description	Qty	Ref.	Part	Description	Qty
7*	161562	PACKING, V-block; nitrile	1	45	107257	SCREW, thread-forming; 1/4-20 x 1/2 in. (13 mm)	4
8*	15H610	PACKING, backup; leather	2	46*	253476	GASKET	1
9*	16A026	RING, retaining	1	47◆	15M568	COVER, valve, outer	1
10	NXT106	BUMPER, piston; includes magnet	1	51▲	15F674	LABEL, safety	1
12	NXT100	POPPET; includes items 12a-12d	2	54★	15H179	DEFLECTOR	1
12a		. O-RING; buna-N	1	55★	107257	SCREW, thread-forming; 1/4-20 x 1/2 in. (13 mm)	2
12b	NXT101	. O-RING; buna-N	1	56	15H190	SEAL, exhaust	1
12c†		. O-RING, backup; buna-N	1	57★	15K345	GASKET; buna-N	1
12d		. O-RING; buna-N	1	58	120206	MUFFLER, poppet	2
13	119050	BOLT, hex hd; 1/2-13 x 8 in. (203 mm)	4	59	277366	BUMPER	1
14	15F639	NUT, with lockwasher; 1/2-13	4	60	116343	SCREW, ground; M5 x 0.8	1
18*	15F449	O-RING, end cap; nitrile	2	61	111307	WASHER, lock; 5 mm	1
20★	119990	O-RING; buna-N	1	62	n/a	PLUG	1
21	15F931	RING, lift	1	63★	15G689	DIFFUSER, exhaust	1
24	NXT104	KIT, low noise exhaust; includes items 20, 25, 44, 54, 55, 56, 57, 63	1	64	108014	O-RING	1
25	120730	SCREW, machine, hex hd; 1/4-20 x 1 in. (25 mm)	5	65	16D001	ADAPTER, lift ring	1
40	NXT107	AIR VALVE ASSEMBLY; see page 40	1	66	C20987	O-RING	1
41	120088	SCREW; 3/8-16 x 4 in. (101 mm)	4	74◆	121162	CLIP, strain relief	1
43	120091	SCREW, thread forming; 1/4-20 x 2 in. (51 mm)	4	75◆	117018	WASHER	1
44	120092	SCREW, thread forming; 1/4-20 x 2-1/2 in. (63 mm)	2	76◆	15M573	WIRE HARNESS, remote	1

Ref.	Description	Air Motor Part Numbers			Qty
		N22LR0	N34LR0	N65LR0	
1	CAP, top	15F955	15F954	15F953	1
2	CYLINDER	NXT204	NXT304	NXT604	1
3	COVER, bottom	NXT202	NXT302	NXT602	1
4	PISTON ASSEMBLY; includes item 10	NXT201	NXT301	NXT601	1
15	MUFFLER	NXT203	NXT303	NXT603	1
17*	O-RING, piston; nitrile	123196	122434	122675	1
30	COVER, top	15G377	15G556	16R866	1

▲ Replacement Danger and Warning labels, tags, and cards are available at no cost.

* Parts included in Repair Kits NXT200 (N22LR0), NXT300 (N34LR0), NXT600 (N65LR0). Purchase separately.

★ Parts included in Low Noise Exhaust Conversion Kit NXT111 (purchase separately).

◆ Parts included in Remote DataTrak Kit NXT406 (purchase separately). Kit also includes items 139 and 144 (see page 41).

† Only used on original poppets (see FIG. 13) made prior to mid-2009.

Parts designated n/a are not available separately.

Air Valve

Part NXT107 Bare Air Valve

Part NXT108 Air Valve with DataTrak Module

Part NXT109 Air Valve with Junction Box

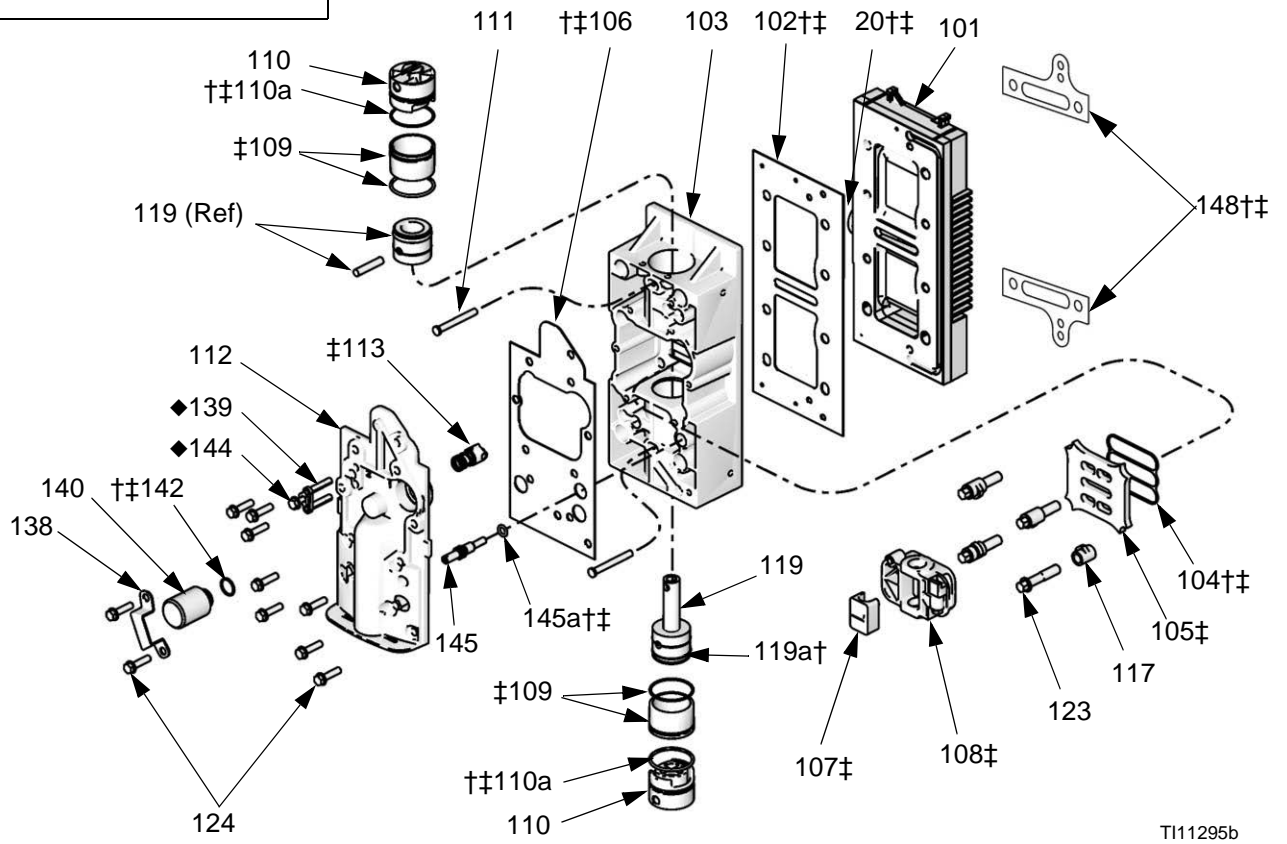
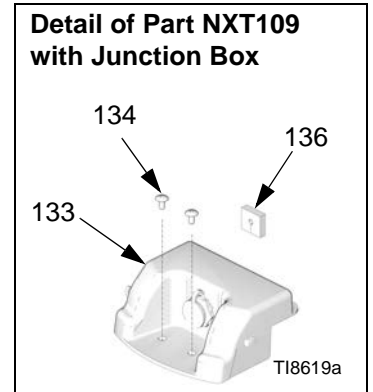
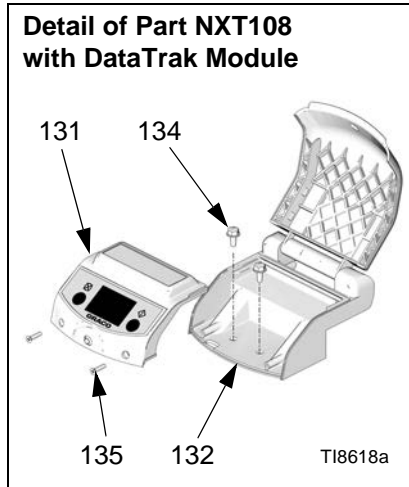

Part NXT107 Bare Air Valve

Part NXT108 Air Valve with DataTrak Module (shown)

Part NXT109 Air Valve with Junction Box Housing

Ref.	Part	Description	Qty	Ref.	Part	Description	Qty
20†‡	119990	O-RING; buna-N	1	135	120279	SCREW, thread forming; #6 x 5/8 in. (16 mm); NXT108 only	2
101	15X996	COVER, exhaust	1	136	15G225	GROMMET, junction box; NXT109 only	1
102†‡	15H633	GASKET, exhaust cover	1	138	15G790	CLIP, solenoid	1
103	15H394	BODY, valve	1	139◆	NXT404	SENSOR, reed switch; includes items 144 and 124 (qty 1); NXT108 and NXT109 only	1
104†‡	15F435	SEAL, plate, valve; nitrile	1	140	NXT403	SOLENOID; 7 Vdc; includes items 138 and 124 (qty 2); NXT108 only	1
105‡	15F438	PLATE, valve	1	277355		PLUG, solenoid port; NXT107 and NXT109 only	1
106†‡	15H634	GASKET, carriage cover	1	142†‡	104130	O-RING; buna-N; NXT107 and NXT109 only	1
107‡	15G055	CARRIAGE, detent, ramp	1	144◆	118605	O-RING; nitrile; NXT108 and NXT109 only	1
108‡	NXT138	CARRIAGE, air cup	1	145	NXT102	CONTROL, de-icing; with knob and o-ring	1
109‡	NXT140	SLEEVE, cylinder; with o-ring	2	145a†‡	159589	O-RING, stem, bleed	1
110	NXT141	STOP, valve piston; with o-ring	2	147	15G722	CARD, diagnostic, multilingual; NXT108 only	1
110a†‡	108014	O-RING, plug, spool	2	148†‡	253476	GASKET, end caps, pair	1
111	15F440	PIN, end cap retainer	2				
112	16A038	COVER, valve	1				
113‡	NXT145	DETENT, spring-loaded (series H air motors or valve covers; marked with "B")	1				
117	15G905	RETAINER, valve plate	4				
119‡	NXT142	VALVE, piston	1				
119a†‡	n/a	SEAL, u-cup, piston, spool	1				
123	120089	SCREW, 3/8-16 x 1-3/4 in. (44 mm)	4				
124	120730	SCREW, machine, hex washer hd; 1/4-20 x 1 in. (25 mm); NXT108 and NXT109	11				
	120730	SCREW, machine, hex washer hd; 1/4-20 x 1 in. (25 mm); NXT107	10				
131	NXT402	MODULE, DataTrak; includes items 131a and 135; NXT108 only	1				
131a	n/a	. FUSE; 63 mA; NXT108 only, see Table 3 on page 15	1				
132	NXT401	HOUSING, DataTrak; includes items 134 and 135; NXT108 only	1				
133	NXT411	JUNCTION BOX ASSEMBLY; includes items 134 and 136; NXT109 only	1				
134	107257	SCREW, thread forming; 1/4-20 x 1/2 in. (13 mm); NXT108 and NXT109 only	2				

† Parts included in Air Valve Seal Repair Kit NXT135 (purchase separately).

‡ Parts included in Air Valve Rebuild Kit NXT144 (purchase separately) for series H (and later) air motors; marked with "B" on cover (112); see **Disassemble the Air Valve**, page 23.

◆ Parts included in Remote DataTrak Kit NXT406 (purchase separately). Kit also includes items 74, 75, and 76 (see page 39).

Parts designated n/a are not available separately.

Dimensions

Air Motor Model	A, inch (mm)	B, inch (mm)	C, inch (mm)	D, inch (mm)
NXT Model 2200	15.6 (394)	16.8 (427)	15.4 (391)	12.4 (315)
NXT Model 3400	15.5 (394)	16.7 (424)	16.1 (409)	14.0 (356)
NXT Model 6500	15.9 (404)	17.1 (434)	18.9 (480)	16.2 (411)

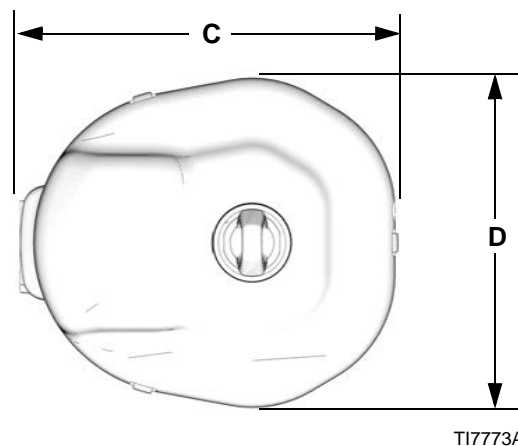
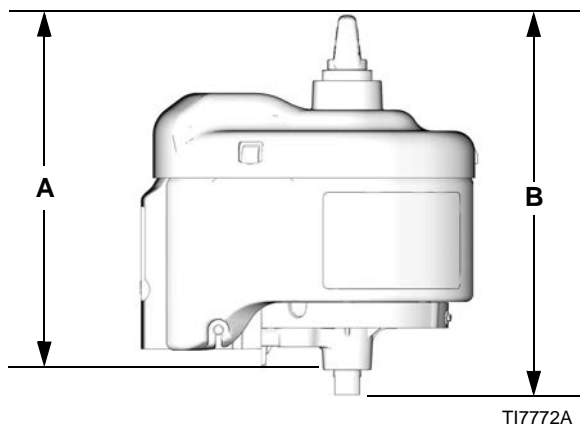

Accessories

Motor/Lower Adapters

The following adapters are available as accessories to connect an NXT air motor to a Graco lower.

Lower	Adapter
High-Flo	15H369
Dura-Flo 600, 750, 900, and 1200	15H370
Dura-Flo 1800 and 2400	15H371
Xtreme	15H392

Air Line Lubricators

Air Motor	Lubricator
NXT 2200	214848
NXT 3400	214848
NXT 6500	214849

DataTrak Conversion Kits

To convert standard NXT air motors to include DataTrak module.

Air Motor	Conversion Kit
NXT 2200	NXT206
NXT 3400	NXT306
NXT 6500	NXT606

111897 Threaded Muffler

1 in. npt(m). For use with remote exhaust manifold.

Integrated Air Control Modules

See Integrated Air Control Modules manual 311239.

Air Control

See Air Controls manual 3A0293.

Mounting Hole Diagrams

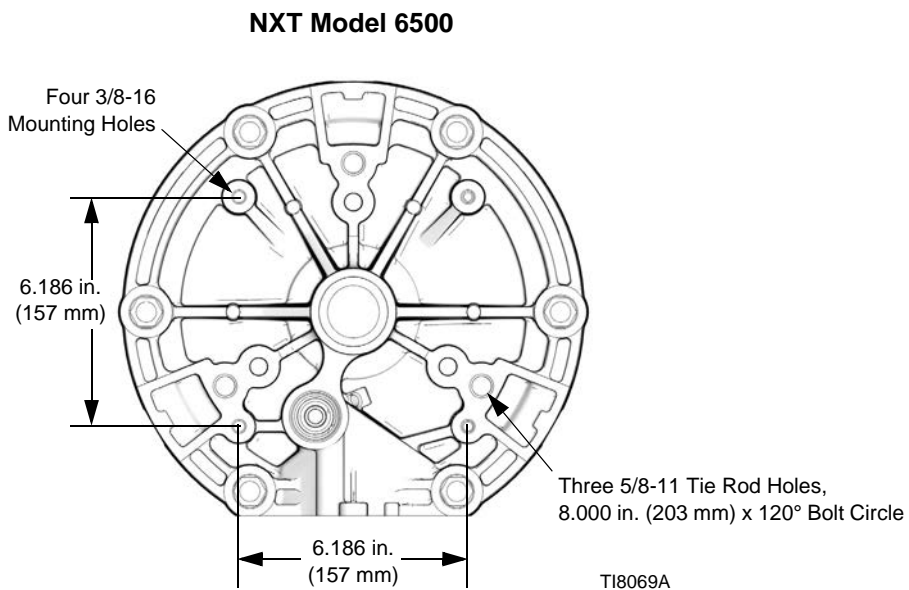
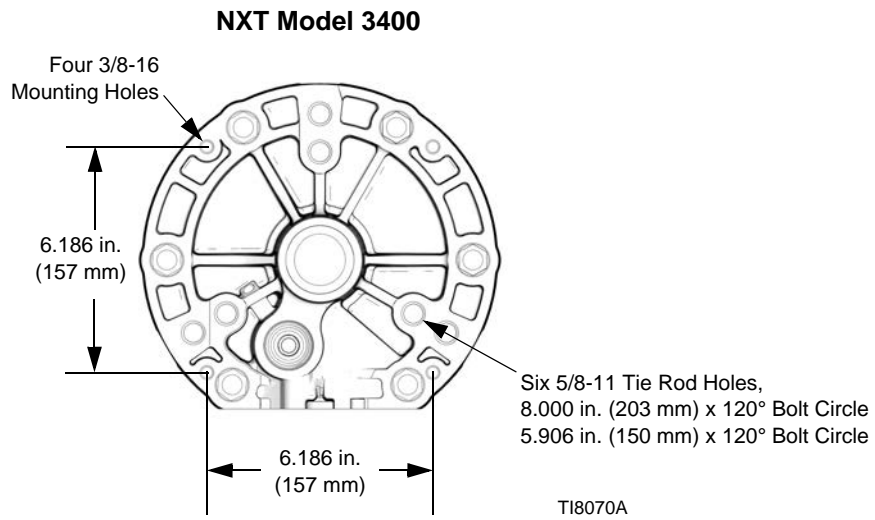
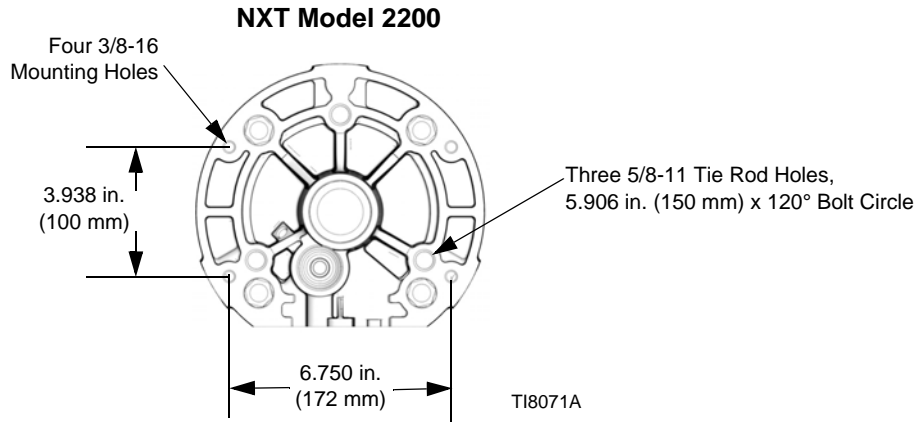

Technical Data

NXT Air Motor		
	US	Metric
Maximum air inlet pressure	100 psi	0.7 MPa, 7.0 bar
Air motor piston diameter		
NXT Model 6500:	10.375 in.	264 mm
NXT Model 3400:	7.5 in.	191 mm
NXT Model 2200:	6.0 in.	152 mm
Stroke length	4.75 in.	120 mm
Air Inlet Size	3/4 npt(f)	
Remote exhaust outlet size (remote models only)	1 in. npt(f)	
Maximum motor speed (Do not exceed maximum recommended speed of fluid pump, to prevent premature pump wear)		
	60 cycles per minute	
Operating temperature range	32-140°F	0-60°C
Materials of construction	Aluminum, ductile iron, stainless steel, carbon steel, acetal, polyethylene, Santoprene®, alloy steel, polypropylene	
Seals and packings	Nitrile rubber	
Weight		
NXT Model 6500:	69 lb	31 kg
NXT Model 3400:	50 lb	23 kg
NXT Model 2200:	46 lb	21 kg

Santoprene® is a registered trademark of the Monsanto Company.

Pin-Out Information for Motor with Linear Sensor

Pin	Description
1	5V Common
2	Voltage Out
3	+5V Supply
4	Shield
5	Extend High Pin
6	Retract High Pin
7	Bottom SW Signal
8	Top SW Signal
9	Common

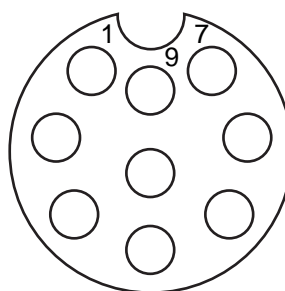

T19239A

Pin-Out Information for Motor with Remote DataTrak Connector

Pin	Description
1	Bottom SW Signal
2	Top SW Signal
3	Common
4	Shield

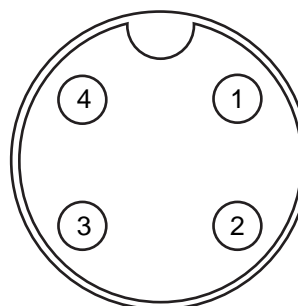

T110950A

Sound Data

Key:

- A 100 psi (0.7 MPa, 7 bar)
- B 40 psi (0.3 MPa, 2.8 bar)

N22DN0 Sound Power

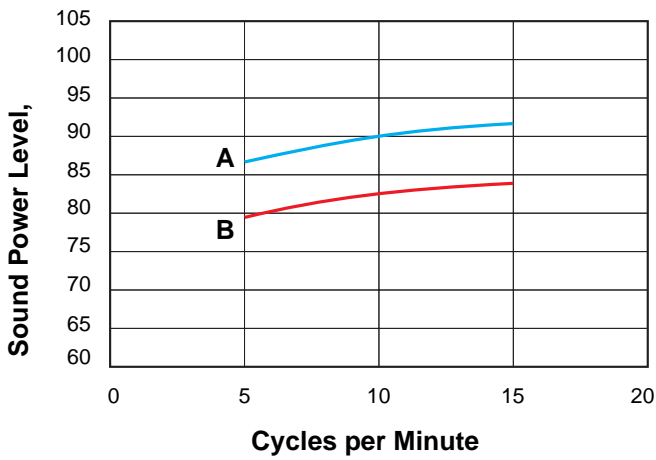

N22DN0 Sound Pressure

(1 m corrected sound pressure levels based on average sound pressure readings assuming free field conditions)

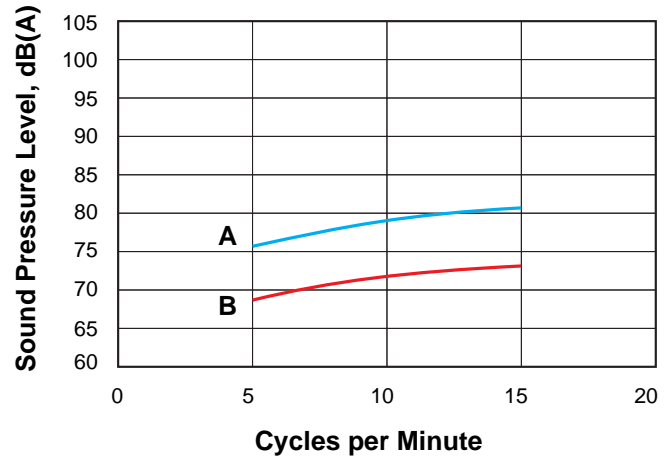

Key:

- A 100 psi (0.7 MPa, 7 bar)
- B 40 psi (0.3 MPa, 2.8 bar)

N22LN0, N34LN2 Sound Power

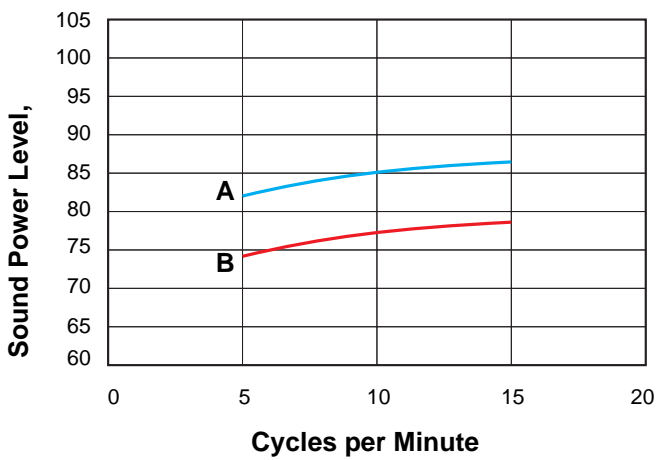

N22LN0, N34LN2 Sound Pressure

(1 m corrected sound pressure levels based on average sound pressure readings assuming free field conditions)

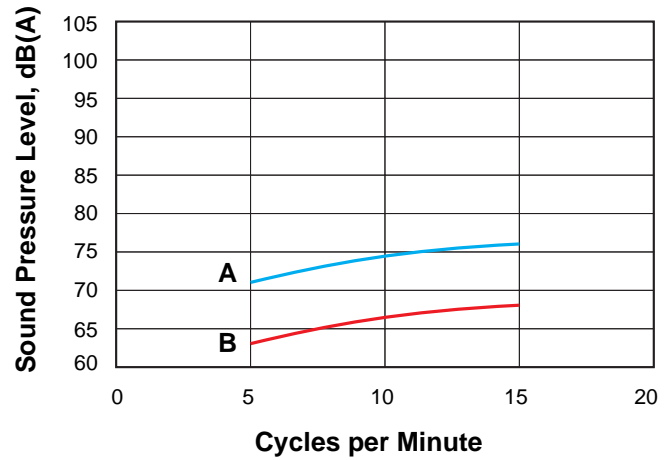

Key:
A 100 psi (0.7 MPa, 7 bar)
B 40 psi (0.3 MPa, 2.8 bar)

N34DN0 Sound Power

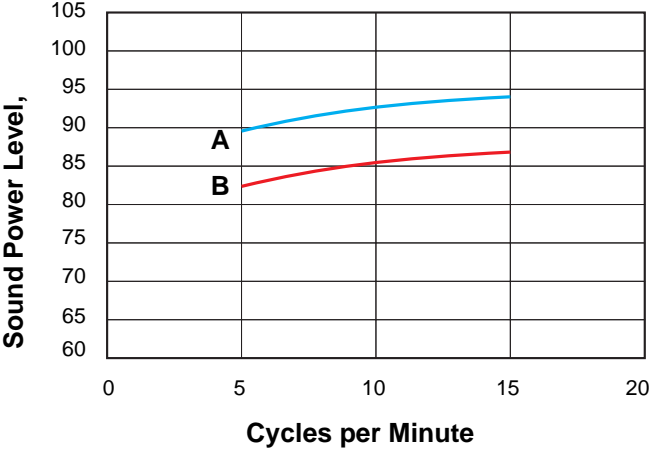

N34DN0 Sound Pressure

(1 m corrected sound pressure levels based on average sound pressure readings assuming free field conditions)

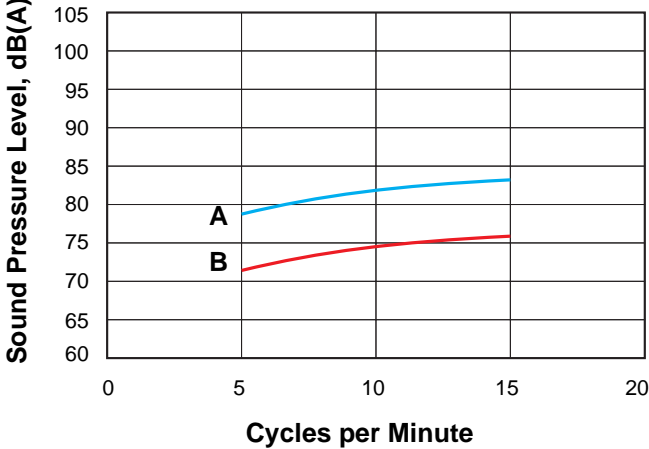

Key:
A 100 psi (0.7 MPa, 7 bar)
B 40 psi (0.3 MPa, 2.8 bar)

N34LN0, N34LN2 Sound Power

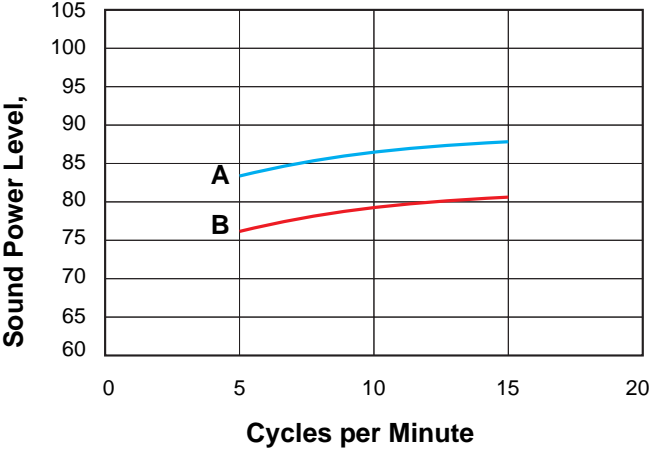

N34LN0, N34LN2 Sound Pressure

(1 m corrected sound pressure levels based on average sound pressure readings assuming free field conditions)

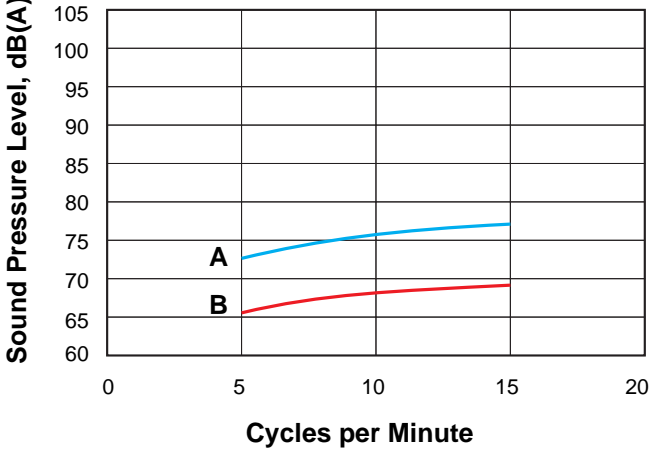

Key:

- A 100 psi (0.7 MPa, 7 bar)
- B 40 psi (0.3 MPa, 2.8 bar)

N65DN0 Sound Power

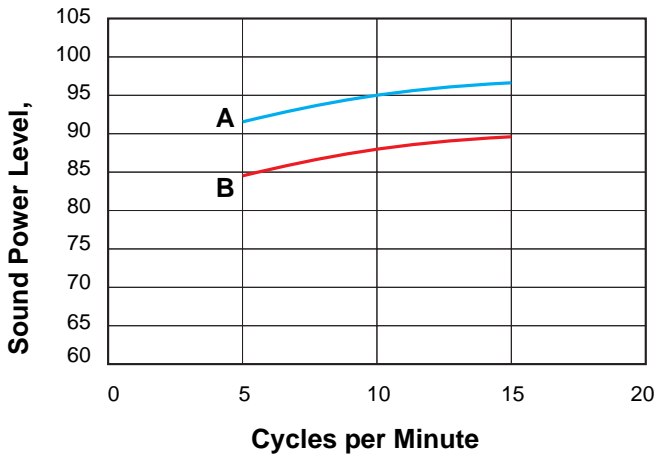

N65DN0 Sound Pressure

(1 m corrected sound pressure levels based on average sound pressure readings assuming free field conditions)

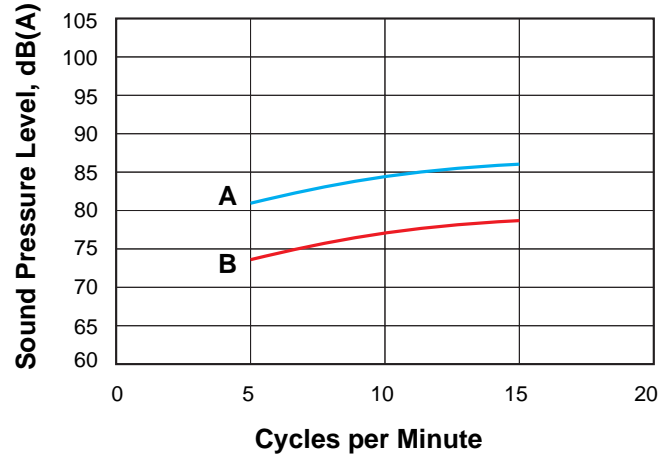

Key:

- A 100 psi (0.7 MPa, 7 bar)
- B 40 psi (0.3 MPa, 2.8 bar)

N65LN0 Sound Power

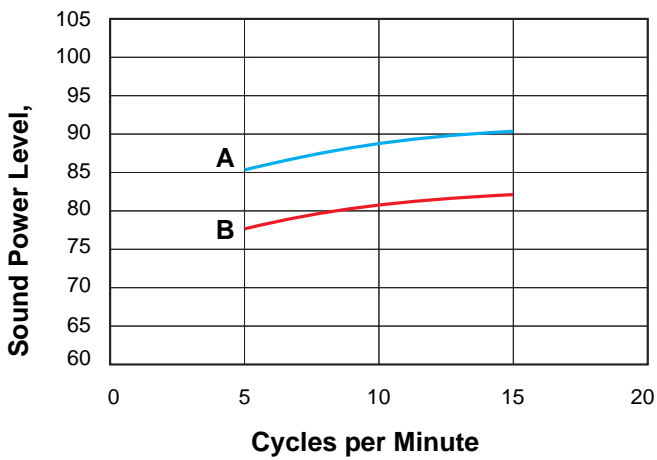

N65LN0 Sound Pressure

(1 m corrected sound pressure levels based on average sound pressure readings assuming free field conditions)

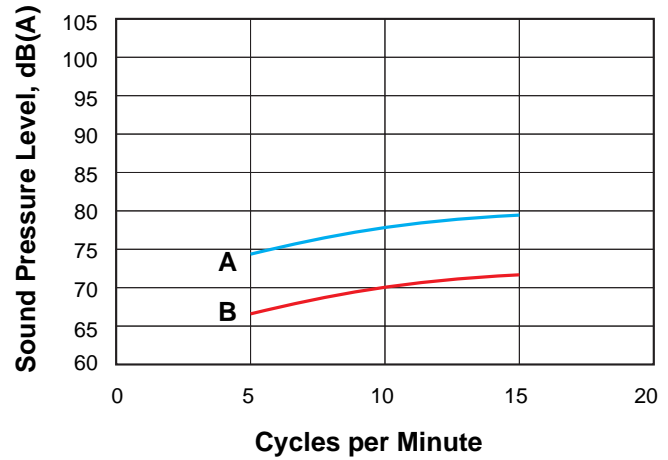



A series of horizontal lines spanning the width of the page, providing a template for technical data or notes.

Graco Standard Warranty

Graco warrants all equipment referenced in this document which is manufactured by Graco and bearing its name to be free from defects in material and workmanship on the date of sale to the original purchaser for use. With the exception of any special, extended, or limited warranty published by Graco, Graco will, for a period of twelve months from the date of sale, repair or replace any part of the equipment determined by Graco to be defective. This warranty applies only when the equipment is installed, operated and maintained in accordance with Graco's written recommendations.

This warranty does not cover, and Graco shall not be liable for general wear and tear, or any malfunction, damage or wear caused by faulty installation, misapplication, abrasion, corrosion, inadequate or improper maintenance, negligence, accident, tampering, or substitution of non-Graco component parts. Nor shall Graco be liable for malfunction, damage or wear caused by the incompatibility of Graco equipment with structures, accessories, equipment or materials not supplied by Graco, or the improper design, manufacture, installation, operation or maintenance of structures, accessories, equipment or materials not supplied by Graco.

This warranty is conditioned upon the prepaid return of the equipment claimed to be defective to an authorized Graco distributor for verification of the claimed defect. If the claimed defect is verified, Graco will repair or replace free of charge any defective parts. The equipment will be returned to the original purchaser transportation prepaid. If inspection of the equipment does not disclose any defect in material or workmanship, repairs will be made at a reasonable charge, which charges may include the costs of parts, labor, and transportation.

THIS WARRANTY IS EXCLUSIVE, AND IS IN LIEU OF ANY OTHER WARRANTIES, EXPRESS OR IMPLIED, INCLUDING BUT NOT LIMITED TO WARRANTY OF MERCHANTABILITY OR WARRANTY OF FITNESS FOR A PARTICULAR PURPOSE.

Graco's sole obligation and buyer's sole remedy for any breach of warranty shall be as set forth above. The buyer agrees that no other remedy (including, but not limited to, incidental or consequential damages for lost profits, lost sales, injury to person or property, or any other incidental or consequential loss) shall be available. Any action for breach of warranty must be brought within two (2) years of the date of sale.

GRACO MAKES NO WARRANTY, AND DISCLAIMS ALL IMPLIED WARRANTIES OF MERCHANTABILITY AND FITNESS FOR A PARTICULAR PURPOSE, IN CONNECTION WITH ACCESSORIES, EQUIPMENT, MATERIALS OR COMPONENTS SOLD BUT NOT MANUFACTURED BY GRACO. These items sold, but not manufactured by Graco (such as electric motors, switches, hose, etc.), are subject to the warranty, if any, of their manufacturer. Graco will provide purchaser with reasonable assistance in making any claim for breach of these warranties.

In no event will Graco be liable for indirect, incidental, special or consequential damages resulting from Graco supplying equipment hereunder, or the furnishing, performance, or use of any products or other goods sold hereto, whether due to a breach of contract, breach of warranty, the negligence of Graco, or otherwise.

FOR GRACO CANADA CUSTOMERS

The Parties acknowledge that they have required that the present document, as well as all documents, notices and legal proceedings entered into, given or instituted pursuant hereto or relating directly or indirectly hereto, be drawn up in English. Les parties reconnaissent avoir convenu que la rédaction du présente document sera en Anglais, ainsi que tous documents, avis et procédures judiciaires exécutés, donnés ou intentés, à la suite de ou en rapport, directement ou indirectement, avec les procédures concernées.

Graco Information

For the latest information about Graco products, visit www.graco.com.

TO PLACE AN ORDER, contact your Graco distributor or call to identify the nearest distributor.

Phone: 612-623-6921 **or Toll Free:** 1-800-328-0211 **Fax:** 612-378-3505

*All written and visual data contained in this document reflects the latest product information available at the time of publication.
Graco reserves the right to make changes at any time without notice.*

For patent information, see www.graco.com/patents.

Original instructions. This manual contains English. MM 311238

Graco Headquarters: Minneapolis

International Offices: Belgium, China, Japan, Korea

GRACO INC. AND SUBSIDIARIES • P.O. BOX 1441 • MINNEAPOLIS MN 55440-1441 • USA

Copyright 2006, Graco Inc. All Graco manufacturing locations are registered to ISO 9001.

www.graco.com

Revision ZAL, May 2016