



Finishing Accessories

High Quality Enhancements for Graco Finishing Systems



PROVEN QUALITY. LEADING TECHNOLOGY



Contents

Pressure Pots

2 Gallon (8 liter)4
5 Gallon (19 liter)5
10 Gallon (38 liter)6
15 Gallon (57 liter)7
2.5 Gallon (9.5 liter)8
Tank Liners9

Agitators

Drum Agitators

Flange Mounted Agitators11
Clamp Mounted Agitators12
Expanding Blade Agitators13
Twistork® Agitators14
Heavy Duty In-Drum Back-Geared Agitator15
Heavy Duty Drum Agitator with Elevator16
Agitator Speed Controller17
Replacement Air Motors18

Pail Agitators

Pail Cover Agitator19
-------------------------------	-----

Tank Agitators

Heavy Duty Pressure Tank Agitators20
--	-----

Electric Agitators

Electric Agitators21
------------------------------	-----

Other Agitators

55 Gallon Drum Covers25
Elevator Systems26

Air Preparation and Controls

3-Stage Desiccant Drying System28
3-Stage Membrane Drying System29
Air Control Unit30
In-line Air Filters and Coalescer31
Low Pressure Air Regulators32
Air Control33
Filters34

Pressure Regulators

Fluid Pressure Regulators

Pressure Regulators Product Matrix37
Low Pressure39
Low Pressure Lightweight Composite40
Precision Flow41
High Pressure Corrosion Resistant42
High Pressure Corrosion Resistant Mini43
High Pressure44

Back Pressure Regulators (BPR)

Low Pressure Corrosion Resistant45
Low Pressure Mini46
Air Operated Corrosion Resistant47
Low Shear Corrosion Resistant48
Low Pressure BPR49
High Pressure BPR50

Gun Controls and Adapters

Gun-Mounted Fluid Regulator51
Fluid Restrictor Valves52
Fluid Adaptors53

Surge Suppressors

High Flow55
In-line56
Tee57

Filters

Stainless Steel High Pressure Filter59
High Pressure Red Alert Filter60
Low Pressure Red Alert Filter61
Model 6 Bag Filter Housings62
Model 6 Bag Filter Elements63
Model 12 Bag Filter Housings64
Model 12 Bag Filter Elements65

Hoses, Fittings, Swivels and Gauges

Bulk Hose and Fittings - Nylon Fluid Hose67
Bulk Hose and Fittings - Braided Fluid Hose68
Bulk Hose and Fittings - Flexible Air Hose69
Coupled Stainless Steel Hoses70
Moisture-Lok Hoses71
High Pressure Swivels72
Automatic Spray Gun Valve73
Check Valves74
Pressure Relief Valve75
Ball Valves76
Pipe Fittings77
Pipe Swivels78
Stainless Fittings79
Fluid and Air Gauges84

Other Accessories

Standard Gun Washer85
Professional Gun Washer86
Fluid Heater Kit87
Siphon Kits88
Ground Strap90



Pressure Pots



Designed with electroplated surfaces that prevent debris build-up and keep your operation free of contaminants, Graco pressure pots are precision welded and surfaced. The siphon tube and bottom outlet of the pressure pot allow for different feed methods, and the liners make clean up easy and mess free. They also meet our stringent internal requirements that exceed industry standards such as ASME and FM.

Pressure Pots are a crucial element of the finishing system and can be used in a variety of applications including:

Fluid Supply Systems for Air Spray or Feeding Other Equipment:

They provide pulse-free, ultra-precise fluid delivery at low pressures and flow rates that are not reliably attained with pumps and other equipment. This is ideal for customers that demand reliable, affordable and easy fluid delivery.

Sealed Reservoir for Moisture Sensitive or Corrosive Materials:

Store your catalyst and other moisture sensitive materials in our sealed pressure tanks to protect material consistency. Pressure tanks are ideal for supplying 2K proportioners with resin or catalyst to ensure an effective and consistent sealing surface for your finishing operation.

Vacuum Tank:

When you need to remove entrapped air from material for precision mixing, Graco pressure tanks provide a great degassing option to eliminate foam from your material to reduce surface defects and pitting.



Pressure Pots

2 Gallon (8 liter)

Pressure Pots

- ASME rated to ensure it meets factory standards
- High quality stainless steel design is compatible with many materials
- Use in stand-alone spraying, material/catalyst supply, or as a moisture sensitive material reservoir



236158

Ordering Information

Capacity	Height in (cm)	Weight lb (kg)	Models with Agitators		Models without Agitators	
			Low Pressure (HVLP) Regulated to 15 psi (1.05 bar, 0.105 MPa)	High Pressure Regulated to 100 psi (7 bar, 0.7 MPa)	Low Pressure (HVLP) Regulated to 15 psi (1.05 bar, 0.105 MPa)	High Pressure Regulated to 100 psi (7 bar, 0.7 MPa)
2 Gallon (8 liter)	26.0 (66.0)	38 (17)	236156	236158		
2 Gallon (8 liter)	25.4 (64.5)	30 (14)			236155	236157

Part Number	Description
236086	Bare tank (pot, lid, gasket only)
236676	Bottom outlet kit
15D058	Tank liner (Qty 20)
111381	Replacement C-Clamps
117572	Standard Santoprene gasket
117575	Premium PTFE coated gasket
236859	Agitator assembly

2 gal (8 l) tank has a direct-drive blade high-speed agitator.
New optional Gun Air Regulator Kit (235042) can be added to all the tanks above.

Instruction manual [308370](#).



Pressure Pots

5 Gallon (19 liter)

Pressure Pots

- ASME rated to ensure it meets factory standards
- High quality stainless steel design is compatible with many materials
- Use in stand-alone spraying, material/catalyst supply, or as a moisture sensitive material reservoir



236149

236152

Ordering Information

Capacity	Height in (cm)	Weight lb (kg)	Models with Agitators		Models without Agitators	
			Low Pressure (HVLP) Regulated to 15 psi (1.05 bar, 0.105 MPa)	High Pressure Regulated to 100 psi (7 bar, 0.7 MPa)	Low Pressure (HVLP) Regulated to 15 psi (1.05 bar, 0.105 MPa)	High Pressure Regulated to 100 psi (7 bar, 0.7 MPa)
5 Gallon (19 liter)	30.5 (77.5)	74 (34)	236146	236152		
5 Gallon (19 liter)	30.5 (77.5)	65 (30)			236143	236149

Part Number	Description
236087	Bare tank (pot, lid, gasket only)
244147	Supply tank (pot, lid, gasket, plugs, fill port cap, pick-up tube, liner)
236677	Bottom outlet kit
15D059	Tank liner (Qty 20)
186517	Stainless steel paddle kit
117571	Standard Santoprene gasket
117574	Premium PTFE coated gasket
236661	Agitator assembly

New optional Gun Air Regulator Kit (235042) can be added to all the tanks above.

All 5, 10 and 15 gal (19, 38, 57 l) pressure tanks with agitators feature heavy-duty back-gearred models.

Instruction manual [308369](#).



Pressure Pots

10 Gallon (38 liter)

Pressure Pots

- ASME rated to ensure it meets factory standards
- High quality stainless steel design is compatible with many materials
- Use in stand-alone spraying, material/catalyst supply, or as a moisture sensitive material reservoir



236153

236150

Ordering Information

Capacity	Height in (cm)	Weight lb (kg)	Models with Agitators		Models without Agitators	
			Low Pressure (HVLP) Regulated to 15 psi (1.05 bar, 0.105 MPa)	High Pressure Regulated to 100 psi (7 bar, 0.7 MPa)	Low Pressure (HVLP) Regulated to 15 psi (1.05 bar, 0.105 MPa)	High Pressure Regulated to 100 psi (7 bar, 0.7 MPa)
10 Gallon (38 liter)	33.9 (88.0)	85 (39)	236147	236153		
10 Gallon (38 liter)	33.9 (88.0)	76 (35)			236144	236150

Part Number	Description
236088	Bare tank (pot, lid, gasket only)
244148	Supply tank (pot, lid, gasket, plugs, fill port cap, pick-up tube, liner)
236677	Bottom outlet kit
15D060	Tank liner (Qty 20)
186517	Stainless steel paddle kit
117571	Standard Santoprene gasket
117574	Premium PTFE coated gasket
236662	Agitator assembly

New optional Gun Air Regulator Kit (235042) can be added to all the tanks above.
 All 5, 10 and 15 gal (19, 38, 57 l) pressure tanks with agitators feature heavy-duty back-gearred models.

Instruction manual [308369](#).



Pressure Pots

15 Gallon (57 liter)

Pressure Pots

- ASME rated to ensure it meets factory standards
- High quality stainless steel design is compatible with many materials
- Use in stand-alone spraying, material/catalyst supply, or as a moisture sensitive material reservoir



Ordering Information

Capacity	Height in (cm)	Weight lb (kg)	Models with Agitators		Models without Agitators	
			Low Pressure (HVLP) Regulated to 15 psi (1.05 bar, 0.105 MPa)	High Pressure Regulated to 100 psi (7 bar, 0.7 MPa)	Low Pressure (HVLP) Regulated to 15 psi (1.05 bar, 0.105 MPa)	High Pressure Regulated to 100 psi (7 bar, 0.7 MPa)
15 Gallon (57 liter)	44.6 (113.2)	101 (46)	236148	236154		
15 Gallon (57 liter)	44.6 (113.2)	92 (42)			236145	236151

Part Number	Description
236089	Bare tank (pot, lid, gasket only)
244149	Supply tank (pot, lid, gasket, plugs, fill port cap, pick-up tube, liner)
236677	Bottom outlet kit
15D060	Tank liner (Qty 20)
15D061	Tank liner (Qty 8)
186517	Stainless steel paddle kit
117571	Standard Santoprene gasket
117574	Premium PTFE coated gasket
236663	Agitator assembly

New optional Gun Air Regulator Kit (235042) can be added to all the tanks above.
 All 5, 10 and 15 gal (19, 38, 57 l) pressure tanks with agitators feature heavy-duty back-gearred models.

Instruction manual [308369](#).



Pressure Pots

2.5 Gallon (9.5 liter) Aluminum Pressure Pots

- Painted aluminum tank ideal for adhesives or other coatings
- Single or dual regulator options for pulsation-free fluid delivery
- Built-in handle for easy movement



223833

Ordering Information

Part No.	Description	Tank Capacity	Max. Working Pressure	Relief Valve Setting	Fluid Inlet	Fluid Outlet	Wetted Parts	Air Inlet	Size (H x W) in (cm)
171226	2-1/2 Gallon Pressure Pot	2.5 gal (9.5 l)	50 psi (3.5 bar, 0.35 MPa)	50 psi (3.5 bar, 0.35 MPa)	1/4 npt(m)	3/8 npsm(m)	Aluminum, brass, steel, buna-N	1/4 npt(m)	21 x 11-1/4 (53 x 286)
223833	2-1/2 Gallon Pressure Pot with Dual Regulators	2.5 gal (9.5 l)	50 psi (3.5 bar, 0.35 MPa)	50 psi (3.5 bar, 0.35 MPa)	1/4 npt(m)	3/8 npsm(m)	Aluminum, brass, steel, buna-N	1/4 npt(m)	21 x 11-1/4 (53 x 286)

Instruction manual: [307133](#)



Pressure Pots

Tank Liners

Pressure Pots

- Tough anti-static material resists cuts and tears for safe and clean handling
- Reduce cleaning time and keep materials segregated
- Reduce changeover time between jobs



Ordering Information

Part No.	Description
15D058	20 count, 2 gal (9 l) pressure tank liners
15D059	20 count, 5 gal (19 l) pressure tank liners
15D060	20 count, 10 gal (45 l) pressure tank liners
15D061	8 count, 15 gal (56 l) pressure tank liners
112077	5 count, 2.5 gal (11 l) pressure tank liners
112078	25 count, 2.5 gal (11 l) pressure tank liners



Agitators



Mixing is step one!

If the material is not properly mixed, it will never reach optimal performance conditions despite the highest quality pumping, proportioning, and spray guns.

Graco offers a complete line of high quality mixing solutions for many different materials and containers. Our **Agitator Speed Controller** ensures that your mixing process can be controlled to eliminate paint shear, foaming, and unnecessary compressed air consumption.

Our mixing equipment will make sure you are set up for success starting with step one.





Agitators

Flange Mounted Agitators for Drum and Mix Tank

Drum Agitators



- Agitators mount directly to mix tank or drum covers
- Dual propeller ensures efficient and thorough mixing
- Easy adjustment knob for fine tuning agitator speed to ideal mixing parameters



207199

Ordering Information

Part No.	Description	Drive	HP	Length in (cm)	Material	Manual
206758	Dual round prop; mounts on cover	Air	1/2	31.25 (79.3)	CS	306840
207199	Includes 206758 and 55 gallon (210 liter) cover 2 in NPSM bung	Air	1/2	31.25 (79.3)	CS (SST cover)	306938
203711	Mounts on 237307 SST cover; agitator supports mount to suction tube or pump cylinder	Air	1/2	31.25 (79.3)	CS	306459
204995	Mounts on 237307 cover; mounts to suction tube or pump cylinder	Air	1/2	31.25 (79.3)	CS	306459
206219	Mounts on 237308 cover	Air	1/2	31.25 (79.3)	CS (SST cover)	306459
207953	Dual round prop (3 blade each)	Air	3/4	29 (73.6)	CS	306840
222698*	Includes single round prop	Air	1/2	31.25 (79.3)	SST	306840
206760	Dual round prop	Air	1.5	33.25 (84.4)	CS, Aluminum	306840
205715	For mastics	Air	2-1/2	33.50 (85)	CS	307277
210068*	With sawblade prop	Air	3/4	33.87 (86)	SST	307154

* Waterborne compatible

Part Number	Description
190192	Agitator cover gasket



Agitators

Clamp Mounted Agitators Drum Agitators



(except
225883)

- Clamp mounts agitator directly to drum
- Adjustable shaft angle to reduce mixing vortex and air entrapment
- Dual propeller ensures efficient and thorough mixing
- Easy adjustment knob for fine tuning agitator speed to ideal mixing parameters



225831

Ordering Information

Part No.	Description	Drive	HP	Length in (cm)	Material	Manual
225883	Includes dual round prop; open drum	Air	2-1/2	41.5 (105.4)	CS, Iron, Aluminum	306426
225831	Includes dual round prop; open drum	Air	1	41.5 (105.4)	CS, Aluminum, Ductile Iron, Bronze	306358



Agitators

Expanding Blade Agitators

Drum Agitators



- Corrosion resistant materials
- Threads into 1.5” or 2” drum bung
- Includes angled adapter reduces vortexing and allows for off center mounting
- Customize configuration by adjusting blade height or by adding additional blade assemblies
- Collapsible blades fit through drum bung and expand when spinning for efficient mixing



24C728

Ordering Information

Part No.	Description	Drive	HP	Max. Air Input psi (bar)	Max. Speed Recommended	Wetted Parts
24C728	Low Viscosity (1,000 cps) air driven expanding blade bung-mounted agitator	Air	1	100 (7)	500 rpm	303, 18-8 and 304 SST
24C729	High Viscosity (2,000 cps) air driven expanding blade bung-mounted agitator	Air	1.75	100 (7)	500 rpm	303, 18-8 and 304 SST

Instruction manual: [313643](#)



Agitators

Twistork® Agitators Drum Agitators



- Helix blade effectively mixes higher viscosity materials
- Mounts directly to 2 inch drum bung
- Stainless and carbon steel material options
- Siphon model allows material transfer through agitator shaft
- Sealed agitator drive prevents material contamination and evaporation
- ATEX approval for hazardous locations
- Max viscosity 10,000 cps



236629

Ordering Information

Part No.	Description	Drive	HP	Length in (cm)	Material	Manual
224854	Twistork, reversible, non-siphon	Air	1-1/2	37.25 (95)	CS	308175
235534	Twistork, reversible, non-siphon	Air	1-1/2	37.25 (95)	304 SST	308175
236629*	Twistork, standard siphon model	Air	3/4	47.5* (121)	304 SST	308345
236760	Oil-less, reversible, siphon model	Air	3/4	47.5* (121)	304 SST	308345

*Adjustable depth models for drums 31-1/2 in to 35-1/2 in (80 cm to 90.1 cm) deep. Siphon tube designed to rest on drum bottom.



Agitators

Heavy Duty In-Drum Back-Geared Agitator



Drum Agitators

- Corrosion resistant materials for high quality and long life
- Leak-free gearbox eliminates material contamination common with oil filled units
- Installs easily onto in-drum agitators
- Mounts directly to drum bung, choose 1.5 in or 2 in
- Includes 3/8 in, 7/16 in, 1/2 in, 5/8 in shaft adapters, compatible with several styles
- ATEX approval for hazardous locations



24C293

Ordering Information

Part No.	Description	Gear Reducer Ratio	Max. Air Input psi (bar)	Max. Speed Recommended	Wetted Parts
24C293	1.5 inch Bung Model Includes heavy duty agitator drive, plus 2 adapters for 4 different shaft sizes (3/8, 7/16, 1/2 and 5/8 inch)	24:1	100 (7)	100 rpm	303 SST
24C522	2 inch Bung Model Includes heavy duty agitator drive, plus 2 adapters for 4 different square drive sizes (3/8, 7/16, 1/2 and 5/8 inch)	24:1	100 (7)	100 rpm	303 SST
16A521	1.5 inch bung adapter				
16A754	2 inch bung adapter				
16H554	3/8 inch and 7/16 inch shaft adapter				
16H555	1/2 inch and 5/8 inch shaft adapter				

* Waterborne compatible

Instruction manual: [308609](#)



Agitators

Heavy Duty Drum Agitator

Elevators



- Heavy duty gearbox mixes high viscosity materials
- Leak-free and oil-less gearbox prevents material contamination
- Stainless steel agitator and cover for corrosion resistance and waterborne compatibility
- Twin paddles thoroughly mix finishing materials
- Siphon option allows material transfer through agitator shaft
- Access port for easy sampling and inspection of material during operation
- Maximum viscosity 3,000 cps



231414

Ordering Information

Part No.	Description	Drive	HP	Length inches (cm)	Material	Manual
• 231414	Heavy-duty back-gear agitator with elevator, drum cover and siphon kit	Air	1/2	32 (81.25)	SST	308609
• 231413	Same as 231414, except without siphon capability	Air	1/2	32 (81.25)	SST	308609
• 238157	Heavy-duty back-gear agitator	Air	1/2	32 (81.25)	SST	308609
• 240209	Same as 238157 with siphon kit	Air	1/2	32 (81.25)	SST	308609
• 238250	Siphon tube kit; fits 238157 agitator 3/4" ID and 1" npt(m) thread			43 (109)	SST	308609
• 191920	Shaft extension; fits 238157 agitator. Do not use with siphon kit 238250			7 (17.8)	SST	308609
• 191606	Shaft extension; fits 238157 agitator. Do not use with siphon kit 238250			16 (40.6)	SST	308609

- Waterborne compatible

Part Number	Description
238283	Drum cover for agitator 238157 Includes inspection port, return port and mounting holes for agitator.



Agitators

Agitator Speed Controller

Drum Agitators

- Provides closed-loop speed control for agitators
- Maintains constant set speed even as viscosity or drum levels change
- Installs within minutes
- Prevents over-agitation of shear sensitive materials and foaming of waterborne materials
- Extends agitator lifetime by eliminating agitator over speeding
- Lowers energy costs by reducing air consumption



24G621

Ordering Information

Part No.	Description
24G621	Agitator Speed Controller

Compatible Graco Agitators

24C821, 24C524, 24C520, 240209,
231414, 222698, 207199, 204995,
24C729, 24C523, 24C519, 238157,
231413, 210068, 206760, 204482,
24C728, 24C522, 24C293, 236629,
225831, 210067, 206758, 203711

Compatible Graco Air Motors

101140, 16A871, 101388, 111310

Instruction manual: [3A1315](#)



Agitators

Replacement Air Motors

Drum Agitators

- Replacement air motors will give new life your existing agitators
- Use the chart below to determine compatibility
- Easy to select and install



101140

Ordering Information

Air Motor Part No.	Repair Kit Part No.	Compatible Agitator Part No.
101140	207335	203711, 204482, 204995, 206219, 206758, 207953, 210067, 210068, 222698, 236097, 236629, 238157, 238859, 238860, 240209, 962947, 24C293, 24C522
162425	207335	236146, 236147, 236148, 236152, 236153, 236154, 236661, 236662, 236663
111310	224954	224854, 235534, 24C729
101687	207337	224571, 224572
101388	207336	206706, 225831



Agitators

Pail Cover Agitator

Pail Agitators

- Lift handles for easy moving and color changes
- Locking bolts to secure cover and reduce spills
- Ideal for wall mount pumps or spray packages



Ordering Information

Part No.	Size	Description	Drive	HP	Length in (cm)	Material	Manual	Notes
• 222695	5 gal (18 l)	Round prop	Air	1/4	13.25 (33.6)	SST	307968	224571 Agitator and hose
• 204536	5 gal (18 l)	Round prop (3 blade)	Air	1/4	13.25 (33.6)	SST	306565	224571 Agitator and metal tube
226086	5 gal (18 l)	Pail cover, round prop	Air	1/4	13.25 (33.6)	CS	306670	224571 Agitator and CS pail cover
243340	5 gal (18 l)	SST pail cover with SST agitator	Air	1/4	13.25 (33.6)	SST	306565	224571 Agitator and SST pail cover
245081	5 gal (18 l)	SST pail agitator kit for Triton pkgs	Air	1/2	13.25 (33.6)	SST	309305	
245895	5 gal (18 l)	CS pail cover with SST agitator	Air	1/4	13.25 (33.6)	CS	306565	
• 224572	10 gal (37 l)	Single round prop (3 blade)	Air	1/4	17.25 (43.8)	SST	306565	

- Waterborne compatible



Agitators

Heavy Duty Pressure Tank Agitators Tank Agitators



- 20:1 gear reduction to mix high viscosity materials, even at low speeds
- Sealed agitator shaft to prevent air leakage and contamination
- Built-in baffle and support for efficient mixing
- Compatible with Graco pressure tanks



236661

Ordering Information

Part No.	Description	Drive	HP	Length in (cm)	Material	Manual
• 236661	5 gallon (19 liter), gear reduced	Air	1/2	15 (38)	304/316 SST	308371
• 236662	10 gallon (38 liter), gear reduced	Air	1/2	20.75 (53)	304/316 SST	308371
• 236663	15 gallon (57 liter), gear reduced	Air	1/2	31 (79)	304/316 SST	308371

- Waterborne compatible

*Only use on Graco's 5, 10 and 15 gal ASME pressure tanks.

Part Number	Description
186517	304 SST Paddle Kit for 5, 10, 15 gallon (18.9, 38, 57 l) sizes Used to upgrade from standard composite agitator paddle to stainless steel construction, for enhanced chemical resistance.



Electric Agitators

Electric Agitators

- Low shear mixing ensures uniform particle dispersion without material degradation
- Compatible with waterborne and solventborne materials
- Sealed gearbox eliminates maintenance
- Lubrication-free shaft seal prevents solvent attack of agitator bearings and gearbox
- Efficient motor provides superior mixing performance with less energy consumption
- Inverted duty motor for variable speed adjustment via variable frequency drive (VFD)



Manual number [310500](#)

Motor Specifications

LSA 200 System	
Electric-Powered Motor	3 phase, Class 1 Group D Explosion-proof
Gear Reduction	5:1
Power	0.25 HP
Speed	1750 rpm
Output	350 rpm
Electrical	230/460 volt
Electrical consumption at 460 volt	0.58 amps
Construction: Shaft and impeller	316 SST
Mounting plate	electroless nickel plating
Shaft Diameter	16 mm
Height	
Weight	

LSA 220 System	
Electric-Powered Motor	3 phase, Class 1 Group D Explosion-proof
Gear Reduction	6:3:1
Power	0.25 HP
Speed	1750 rpm
Output	280 rpm
Electrical	230/460 volt
Electrical consumption at 460 volt	0.58 amps
Construction: Shaft and impeller	316 SST
Mounting plate	electroless nickel plating
Shaft Diameter	16 mm
Height	
Weight	

LSA 300 System	
Electric-Powered Motor	3 phase, Class 1 Group D Explosion-proof
Gear Reduction	6:3:1
Power	0.25 HP
Speed	900 rpm
Output	140 rpm
Electrical	230/460 volt
Electrical consumption at 460 volt	0.58 amps
Construction: Shaft and impeller	316 SST
Mounting plate	electroless nickel plating
Shaft Diameter	20 mm
Height	
Weight	

Mounting Specifications

Bolt Pattern

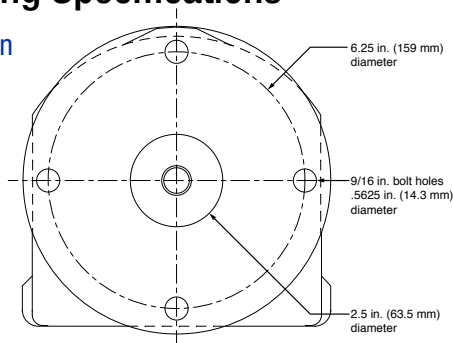



Electric Agitators

Order your Electric Agitator in 3 Easy Steps!



Sizing Guide

Use volume and viscosity to determine model and blade diameter.

LSA 200

Tank Volume	Fluid Viscosity (cps)	Recommended Blade Diameter
40 - 120 Gal (150 - 400 l)	<100	7.6 in (193 mm)
	100 - 200	8.8 in (224 mm)
	200 - 350	10.0 in (254 mm)
120 - 160 Gal (450 - 600 l)	<100	8.8 in (224 mm)
	100 - 200	10.0 in (254 mm)
160 - 200 Gal (600 - 750 l)	<100	10.0 in (254 mm)

LSA 220

Tank Volume	Fluid Viscosity (cps)	Recommended Blade Diameter
130 - 160 Gal (490 - 600 l)	<100	10.0 in (254 mm)
	100 - 200	11.2 in (284 mm)
	200 - 350	11.8 in (299 mm)
160 - 200 Gal (600 - 750 l)	<100	11.2 in (284 mm)
	100 - 200	11.8 in (299 mm)
200 - 300 Gal (750 - 1100 l)	<100	12.8 in (325 mm)

LSA 300

Tank Volume	Fluid Viscosity (cps)	Recommended Blade Diameter
200 - 300 Gal (750 - 1100 l)	<100	15.6 in (396 mm)
	100 - 200	17.0 in (432 mm)
	200 - 350	18.0 in (457 mm)
300 - 400 Gal (1100 - 1500 l)	<100	18.0 in (457 mm)
	100 - 200	19.0 in (483 mm)
400 - 500 Gal (1500 - 1900 l)	<100	19.0 in (483 mm)



Tank Dimensions

Use tank dimension diagrams and blade diameter to determine shaft length.

If Z/T exceeds 1.2, consider using dual impellers.

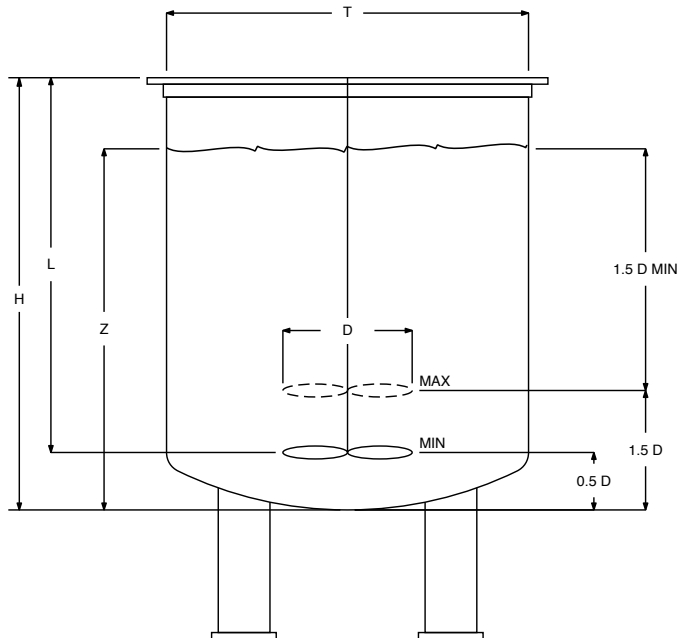

$$L = H - (0.5 D)$$

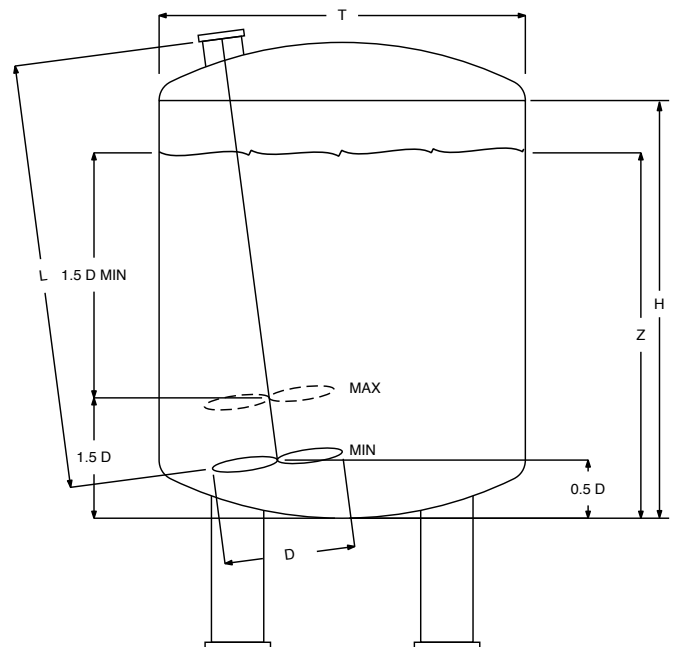

$$L = H - (0.5 D)$$



Electric Agitators

STEP
3

Ordering Information

Select your part number Based on your model, blade diameter and shaft length.

Assembly Number	Agitator Model	Motor P/N	Shaft Length "L"		Shaft P/N	Blade Dia "D"		Blade P/N
			in	mm		in	mm	
922000	200E	516556	29	737	516910	7.6	193	515770
922005	200E	516556	30	762	516911	7.6	193	515770
922203	200E	516556	31	787	516912	7.6	193	515770
922016	200E	516556	32	813	516913	7.6	193	515770
922022	200E	516556	33	838	516914	7.6	193	515770
922025	200E	516556	34	864	516915	7.6	193	515770
922028	200E	516556	35	889	516916	7.6	193	515770
922032	200E	516556	36	914	516917	7.6	193	515770
922198	200E	516556	29	737	516910	8.8	224	515771
922006	200E	516556	30	762	516911	8.8	224	515771
922010	200E	516556	31	787	516912	8.8	224	515771
922205	200E	516556	32	813	516913	8.8	224	515771
962686	200E	516556	33	838	516914	8.8	224	515771
922208	200E	516556	34	864	516915	8.8	224	515771
922029	200E	516556	35	889	516916	8.8	224	515771
922033	200E	516556	36	914	516917	8.8	224	515771
922001	200E	516556	29	737	516910	10	254	515772
922036	220E	516556	29	737	516910	10	254	515772
922200	200E	516556	30	762	516911	10	254	515772
962553	220E	516556	30	762	516911	10	254	515772
922011	200E	516556	31	787	516912	10	254	515772
922047	220E	516556	31	787	516912	10	254	515772
922017	200E	516556	32	813	516913	10	254	515772
922231	220E	516556	32	813	516913	10	254	515772
922023	200E	516556	33	838	516914	10	254	515772
922059	220E	516556	33	838	516914	10	254	515772
922209	200E	516556	34	864	516915	10	254	515772
962764	220E	516556	34	864	516915	10	254	515772
922210	200E	516556	35	889	516916	10	254	515772
962841	220E	516556	35	889	516916	10	254	515772
922253	220E	516556	36	914	516917	10	254	515772
922002	200E	516556	29	737	516910	11.2	284	515773
922037	220E	516556	29	737	516910	11.2	284	515773
922007	200E	516556	30	762	516911	11.2	284	515773
922043	220E	516556	30	762	516911	11.2	284	515773
922012	200E	516556	31	787	516912	11.2	284	515773
922048	220E	516556	31	787	516912	11.2	284	515773
922206	200E	516556	32	813	516913	11.2	284	515773
962674	220E	516556	33	838	516914	11.2	284	515773
922243	220E	516556	34	864	516915	11.2	284	515773
922249	220E	516556	35	889	516916	11.2	284	515773
962642	220E	516556	36	914	516917	11.2	284	515773
922213	220E	516556	29	737	516910	11.8	300	515774
922219	220E	516556	30	762	516911	11.8	300	515774
922225	220E	516556	31	787	516912	11.8	300	515774
922232	220E	516556	32	813	516913	11.8	300	515774
922238	220E	516556	33	838	516914	11.8	300	515774
922244	220E	516556	34	864	516915	11.8	300	515774
922250	220E	516556	35	889	516916	11.8	300	515774
922254	220E	516556	36	914	516917	11.8	300	515774
922214	220E	516556	29	737	516910	12.8	325	515775
922220	220E	516556	30	762	516911	12.8	325	515775
922226	220E	516556	31	787	516912	12.8	325	515775
922233	220E	516556	32	813	516913	12.8	325	515775
922239	220E	516556	33	838	516914	12.8	325	515775
922245	220E	516556	34	864	516915	12.8	325	515775
922215	220E	516556	29	737	516910	13.6	345	515776
922221	220E	516556	30	762	516911	13.6	345	515776
922227	220E	516556	31	787	516912	13.6	345	515776
922234	220E	516556	32	813	516913	13.6	345	515776
922080	300E	516558	34	864	516915	15.1	384	51A018
922085	300E	516558	34	864	516915	15.1	384	51A018
922090	300E	516558	35	889	516916	15.1	384	51A018

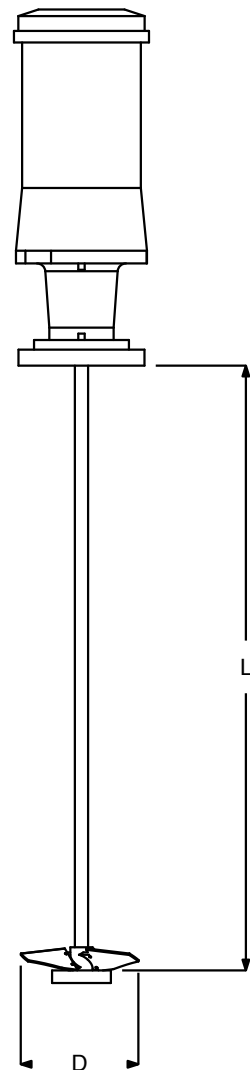



Electric Agitators

Ordering Information (continued)

Select your part number Based on your model, blade diameter and shaft length.

Assembly Number	Agitator Model	Motor P/N	Shaft Length "L"		Shaft P/N	Blade Dia "D"		Blade P/N
			in	mm		in	mm	
962742	300E	516558	36	914	516920	15.1	384	51A018
922107	300E	516558	37	940	516921	15.1	384	51A018
922116	300E	516558	38	965	516922	15.1	384	51A018
922126	300E	516558	39	991	516923	15.1	384	51A018
922135	300E	516558	40	1016	516924	15.1	384	51A018
922145	300E	516558	41	1041	516925	15.1	384	51A018
96A272	300E	516558	42	1067	516926	15.1	384	51A018
962795	300E	516558	43	1092	516927	15.1	384	51A018
922169	300E	516558	44	1118	516928	15.1	384	51A018
922179	300E	516558	45	1143	516929	15.1	384	51A018
962828	300E	516558	46	1168	516930	15.1	384	51A018
922081	300E	516558	34	864	516915	15.6	396	515777
922091	300E	516558	35	889	516916	15.6	396	515777
922100	300E	516558	36	914	516920	15.6	396	515777
962715	300E	516558	37	940	516921	15.6	396	515777
922117	300E	516558	38	965	516922	15.6	396	515777
922127	300E	516558	39	991	516923	15.6	396	515777
922136	300E	516558	40	1016	516924	15.6	396	515777
922146	300E	516558	41	1041	516925	15.6	396	515777
962730	300E	516558	42	1067	516926	15.6	396	515777
922161	300E	516558	43	1092	516927	15.6	396	515777
922170	300E	516558	44	1118	516928	15.6	396	515777
922180	300E	516558	45	1143	516929	15.6	396	515777
922189	300E	516558	46	1168	516930	15.6	396	515777
922082	300E	516558	34	864	516915	17	432	515778
922092	300E	516558	35	889	516916	17	432	515778
962568	300E	516558	36	914	516920	17	432	515778
922108	300E	516558	37	940	516921	17	432	515778
922118	300E	516558	38	965	516922	17	432	515778
922128	300E	516558	39	991	516923	17	432	515778
922137	300E	516558	40	1016	516924	17	432	515778
922147	300E	516558	41	1041	516925	17	432	515778
962731	300E	516558	42	1067	516926	17	432	515778
922162	300E	516558	43	1092	516927	17	432	515778
922171	300E	516558	44	1118	516928	17	432	515778
922181	300E	516558	45	1143	516929	17	432	515778
922190	300E	516558	46	1168	516930	17	432	515778
922083	300E	516558	34	864	516915	18	457	515779
922093	300E	516558	35	889	516916	18	457	515779
922101	300E	516558	36	914	516920	18	457	515779
922109	300E	516558	37	940	516921	18	457	515779
922119	300E	516558	38	965	516922	18	457	515779
922129	300E	516558	39	991	516923	18	457	515779
922138	300E	516558	40	1016	516924	18	457	515779
922148	300E	516558	41	1041	516925	18	457	515779
922155	300E	516558	42	1067	516926	18	457	515779
922163	300E	516558	43	1092	516927	18	457	515779
922172	300E	516558	44	1118	516928	18	457	515779
922182	300E	516558	45	1143	516929	18	457	515779
922191	300E	516558	46	1168	516930	18	457	515779
922084	300E	516558	34	864	516915	19	483	515780
922094	300E	516558	35	889	516916	19	483	515780
922102	300E	516558	36	914	516920	19	483	515780
922110	300E	516558	37	940	516921	19	483	515780
922120	300E	516558	38	965	516922	19	483	515780
922130	300E	516558	39	991	516923	19	483	515780
922139	300E	516558	40	1016	516924	19	483	515780
922149	300E	516558	41	1041	516925	19	483	515780
922156	300E	516558	42	1067	516926	19	483	515780
922164	300E	516558	43	1092	516927	19	483	515780
922173	300E	516558	44	1118	516928	19	483	515780
922183	300E	516558	45	1143	516929	19	483	515780
922192	300E	516558	46	1168	516930	19	483	515780

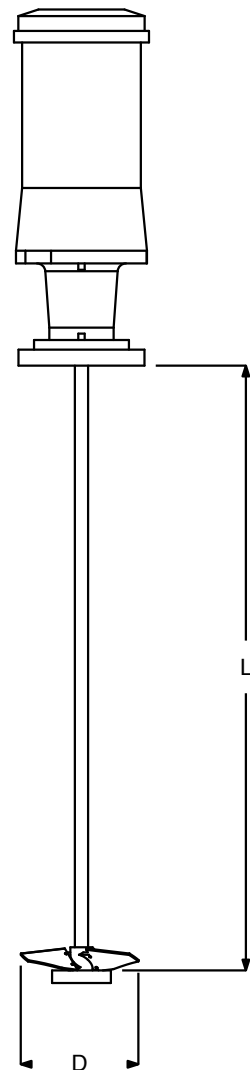



Agitators

Drum Covers

- Integrate pumps, agitators, and accessories with drum, elevator system, and other containers
- Many mounting options and configurations
- Inspection port for clean and easy monitoring
- Stainless steel construction is compatible with catalyst, waterborne, and other finishing materials
- Create custom solutions with bare cover (238008)

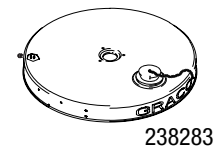
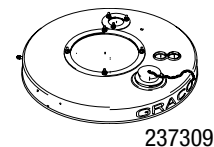
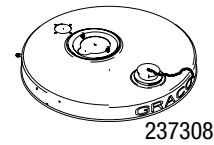
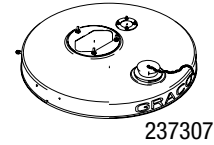
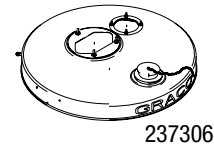

Ordering Information

Part No.	Graco Pump Support	Features	Material	Manual
• 237306	President, Monark, Standard and Fast-Flo	Includes inspection port plug, bolts, nuts, and gaskets. Fits agitator 206758 and siphon tube 206266.	304 SST	308466
• 237307	President and Monark	Includes inspection port plug, bolts, nuts, and gaskets. Fits agitators 204995 and 203711.	304 SST	308466
• 237308	President (two bolt mounting)	Includes inspection port plug, bolts, nuts, and gaskets. Fits agitators 204995, 206219 and filter 214724.	304 SST	308466
• 237309	King, Bulldog, Senator, and President	Includes inspection port plug, bolts, nuts, and gaskets. Fits agitator 205715 and air regulator 207651 (King), and air regulator 205712 (Bulldog).	304 SST	308466
• 237949	Glutton	Features inspection port plug, agitator port; return tube ports, Glutton bolt holes and siphon tube port.	304 SST	308466
• 238008	Most Graco pumps except Premier	Features only inspection port with plug. No other holes. Additional holes cut to fit particular application.	304 SST	308466
• 190206	Most Graco pumps except Premier	Blank cover with no holes. Heavy duty 12 gauge SST. Not passivated.	304 SST	308466
• 238283	Fits agitator 238157 and electric agitators	Includes inspection port, return port and mounting holes for agitator.	304 SST	308609

- Waterborne compatible



Agitators

Elevator Systems

- Safely and easily raise and lower cover mounted pumps and agitators
- Includes lift, up/down air control, and cover support (cover not included)
- Mounts directly to floor or plate (205339)



Ordering Information

Part No.	Features	Material	Manual
237746	Includes elevator 204385, air control valve 237579, floor mount base and drum cover support 237578.	Steel	306287
204352	Includes elevator 204385 and bracket 204510.	Steel	306568
204385	Elevator only with stationary base.	Steel	306287
206276	Air control kit. Used with Bulldog or King pump mounted on a heavyduty elevator. Includes air regulator with gauge restrictor valve, push-pull valve, air-assist valve, hose and fitting for directing air to pump, elevator and inductor plate.		
207561	Air control kits. Elevator up/down control		306287
237579	Air control kit similar to 206276; plus includes air tube and mounting bracket to locate push-pull control on front edge of stainless steel drum cover.		306287
204510	Wishbone support and controls for up/down. Used with Fire-Ball, Monark, President in-line pump		306568
237902	Bulldog, King Drum Cover Mount Includes elevator 207408, pump support 237578, and air control kit 237579.	Steel	306287
237525	Elevator Retrofit Kit Designed to adapt elevators with old support ring to fit new SST drum covers 237306 thru 237310, 190206, 238008 and others. Drum support not included.	Steel	308467
204490	Monark (224350) and President (224348). Includes elevator, inductor plate, pump bracket, up/down control, air hose and steel base. Requires pump adapter 161251. Also requires flange (160754).	Steel	306556
205339	Elevator Base Plate Provides stable surface if floor is too irregular for proper operation. Use with 207408 and 204385.	Steel	306556



Air Preparation and Controls



Air preparation is key to controlling the finishing process and prolonging the life of finishing equipment. Graco offers a wide range of air preparation equipment to meet all of your finishing needs. Our 3 stage desiccant or membrane drying system allows you to provide dry, clean air to your entire finishing system to achieve a high quality finish.

We also have an extensive range of high quality filter-regulator-lubricators (FRLs) so clean, lubricated air reaches your pneumatic equipment at the correct pressure – regardless of system fluctuations. High quality compressed air is an important asset to any finishing operation. Ensure you are utilizing compressed air to the fullest with Graco Air Preparation Equipment.



Air Preparation and Controls

3-Stage Desiccant Drying System

Air Preparation Systems

- Ensures equipment is supplied with clean, dry air
- Multi-stage filter removes particles down to 0.01 micron
- Desiccant removes moisture from air
- Includes shut-off valve and pressure regulator
- Filter and desiccant indicators signal replacement to ensure optimal efficiency



234401

Ordering Information

Part No.	Description	Air Inlet	Air Outlet	Air Flow Capacity	Max. Operating Pressure
234401	3 stage system includes: 234402., 234403 and 234404				
234402	Stage 1 - Air filter with auto drain, removes water and contaminants down to 5 microns.	1/2 in npt(f)	1/2 in npt(f)	108 CFM	175 psi (1.2 MPa, 12 bar)
234403	Stage 2 - Coalescer with auto drain, removes oil and sub-micronic particles down to .01 microns.	1/2 in npt(f)	1/2 npt(f)	35 CFM	175 psi (1.2 MPa, 12 bar)
234404	Stage 3 - Desiccant housing, removes uncondensed moisture	3/4 in reduced to 1/2 in npt(f)	3/4 in reduced to 1/2 in npt(f)	30 CFM	175 psi (1.2 MPa, 12 bar)

Part Number	Description
288810	Replacement desiccant, 5 lb
288823	Replacement desiccant, 20 lb

Instruction manual: [309921](#)



Air Preparation and Controls

3-Stage Membrane Drying System

Air Preparation Systems



234418

- Membrane eliminates the cost and maintenance of desiccant systems
- Ensures equipment is supplied with clean, dry air
- Multi-stage filter removes particles down to 0.01 micron
- Membrane removes moisture from air
- Includes shut-off valve and pressure regulator
- Filter indicator signals replacement to ensure optimal efficiency

Ordering Information

Part No.	Description	Air Inlet	Air Outlet	Air Flow Capacity	Max. Operating Pressure
234418	3 stage systems includes 234406, 234397 and 118560				
234406	Stage 1 - Air filter with auto drain, removes water and contaminants down to 5 microns	1/2" npt(f)	1/2" npt(f)	108 CFM	175 psi (1.2 MPa, 12 bar)
234397	Stage 2 - Coalescer with auto drain, removes oil and sub-micronic particles down to .01 microns	1/2" npt(f)	1/2" npt(f)	70 CFM	175 psi (1.2 MPa, 12 bar)
118560	Stage 3 - Membrane air dryer, removes uncondensed moisture	1/2" npt(f)	1/2" npt(f)	30 CFM	175 psi (1.2 MPa, 12 bar)
234394	Self-relieving air regulator	3/8" npt(f)	1/4" npt(f)	100 CFM	160 psi (1.2 MPa, 11 bar)
U22695	Shut off valve				

Instruction manual: [309920](#)



Air Preparation and Controls

Air Control Unit

Air Preparation Systems

- Ensures equipment is supplied with clean, dry air
- Reusable filter removes particles down to 5 microns
- Includes shut-off valve and pressure regulator ideal for controlling atomizing air for one or many spray guns
- Auto-drain eliminates manual emptying of filters



234398

234400

Ordering Information

Part No.	Description	Max. Air Inlet Pressure	Weight	Max. CFM
234398	Air control unit, filtered main air outlet, two regulated outlets (Filter 234396)	160 psi (1.1 MPa, 11 bar)	5 lb 12 oz (2.6 kg)	120 CFM – Filter 50 CFM – Air Regulator
234399	Air control unit, filtered main air outlet with gauge, two regulated outlets (Filter 234396)	160 psi (1.1 MPa, 11 bar)	6 lb 4 oz (2.8 kg)	120 CFM – Filter 50 CFM – Air Regulator
234400	Air control unit, filtered main air outlet with gauge, three regulated outlets (Filter 234396)	160 psi (1.1 MPa, 11 bar)	7 lb 13 oz (3.5 kg)	120 CFM – Filter 50 CFM – Air Regulator
234411	Air control unit, filtered main air outlet, two regulated outlets (Filter 234410)	160 psi (1.1 MPa, 11 bar)	4 lb 13 oz (2.2 kg)	75 CFM – Filter 50 CFM – Air Regulator

Instruction manual: [309923](#)



Air Preparation and Controls

In-line Air Filters and Coalescers

Air Preparation Systems

- Reusable filter removes particles down to 5 microns
- Coalescer removes contaminants down to 0.01 microns
- Auto-drain eliminates manual emptying of filters
- Built-in filters change indicator signals replacement to ensure optimal efficiency



234408

234405

234409

Ordering Information

Part No.	Description	Air Inlet	Air Outlet	Air Flow Capacity	Maximum Inlet Pressure
234405	Air filter/coalescer assembly (both with auto drain)	1/2" npt (f)	1/2" npt (f)	70 CFM	175 psi (1.2 MPa, 12 bar)
234406	Stage 1 - Air filter with auto drain removes contaminants to 5 microns	1/2" npt (f)	1/2" npt (f)	108 CFM	175 psi (1.2 MPa, 12 bar)
234407	Stage 2 - Coalescer with auto drain removes particles to 0.01 microns	1/2" npt (f)	1/2" npt (f)	70 CFM	175 psi (1.2 MPa, 12 bar)
234408	Air filter with auto drain removes contaminants to 5 microns	3/4" npt (f)	3/4" npt (f)	300 CFM	175 psi (1.2 MPa, 12 bar)
234409	Coalescer with auto drain removes particles to 0.01 microns	3/4" npt (f)	3/4" npt (f)	115 CFM	175 psi (1.2 MPa, 12 bar)

Instruction manual: [309919](#)



Air Preparation and Controls

Low Pressure Air Regulators

Air Controls

- Accurate pressure regulation for consistent process control
- Lightweight design, ideal for use with spray guns
- Economical solution for air pressure regulation



Ordering Information

Part No.	Description	Inlet	Outlet	Handle	Max. Inlet Pressure	Max. CFM
234389	Air regulator with gauge, self-relieving	1/4" npt (m)	1/4" npt (f)	Knob	160 psi (1.1 MPa, 11 bar)	22 CFM at 50 psi (0.3 MPa, 3.5 bar)
234390	Mini-air regulator	1/4" npt (f)	1/4" npt (f)	Knob	160 psi (1.1 MPa, 11 bar)	22 CFM at 50 psi (0.3 MPa, 3.5 bar)
234391	Air regulator, 2 regulated outlets and 1 non-regulated outlet	3/8" npt (f)	1/4" npt (f)	Tee	175 psi (1.2 MPa, 12 bar)	50 CFM at 100 psi (0.7 MPa, 7 bar)
234392	Air regulator, 3 regulated outlets	3/8" npt (f)	1/4" npt (f)	Tee	175 psi (1.2 MPa, 12 bar)	50 CFM at 100 psi (0.7 MPa, 7 bar)
234393	Air regulator 234391 with gauge & shut-off valve, 1 regulated outlet and 1 non-regulated outlet, 0-160 psi (0-1.1MPa, 0-11 bar) gauge	3/8" npt (m)	1/4" npt (f)	Tee	160 psi (1.1 MPa, 11 bar)	50 CFM at 100 psi (0.7 MPa, 7 bar)
234394	Air regulator 234392 with gauge & shut-off valve, 2 regulated outlets, 0-160 psi (0-1.1 MPa, 0-11 bar) gauge	3/8" npt (m)	1/4" npt (f)	Tee	160 psi (1.1 MPa, 11 bar)	50 CFM at 100 psi (0.7 MPa, 7 bar)

Instruction manual [309924](#).



Air Preparation and Controls

Air Control System

Air Controls

- Several outlet options for multiple guns in compact package.
- Adjustable pressure ranges for multiple applications with one easy booth control.
- Ideal for supplying clean air to air spray guns and applicators.
- High quality valves and regulators ensure long life and accurate control.



217075

Ordering Information

Part No.	Inlet npt	Outlet npt(m)	Manual
217075	1/2 (f)	Two 1/4 regulated or Two 1/4 unregulated	307476



Air Preparation and Controls

Air Filter

Filter

- Centrifugal filter element removes contaminants and water
- Visual indicator for viewing filter contents



106150

Ordering Information

Part No.	Inlet/ Outlet	Max. WPR			Max CFM at 100 psi (m3/min)	Micron Element	Material	Size (w x h x d) in (cm)
		psi	bar	MPa				
106150	3/4(fxf)	250	17.2	1.72	250 (7.0)	40	Zinc-plated	4.0 x 8.8 x 7.8 (10 x 22 x 20)
112859	1(fxf)	250	17.2	1.72	350 (10.0)	40	Zinc-plated	4.5 x 8.8 x 7.9 (12 x 22 x 20)
217074	1/2(fxf)	250	17.2	1.72	106 (3.0)	40	Zinc-plated	3.0 x 7.5 x 6.6 (7.6 x 19 x 17)
106148	3/8(fxf)	250	17.2	1.72	77 (2.2)	20	Zinc-plated	2.5 x 6.0 x 3.1 (6.4 x 15 x 7.9)
106149	1/2(fxf)	250	17.2	1.72	106 (3.0)	20	Zinc-plated	3.3 x 6.8 x 6.3 (8.3 x 17 x 16)



Air Preparation and Controls

Lubricators

- Lubricator automatically adds lubricant to air line
- Control knob adjusts lubrication amount
- Sight window for viewing and adjusting droplet size



214848

Ordering Information

Part No.	Inlet/ Outlet	Max. WPR			Material	Size (w x h x d) in (cm)	Bowl Capacity
		psi	bar	MPa			
214848	1/2(f)	250	17.2	1.72	Zinc	3.3 x 7.9 (8.3 x 20)	8 oz (0.24 l)
214849	3/4(f)	250	17.2	1.72	Zinc	4.0 x 9.9 (10.3 x 25.1)	16 oz (0.5 l)

Air Regulators

- Multiple outlets for connecting equipment, gauges, or ball valves
- Accurate adjustment of air pressure for process control



110318



104266

Ordering Information

Bare Part No.	Assembly Part No.	Inlet/ Outlet	Gauge Ports (npt)	Regulated Pressure			Max CFM at 100 psi (m3/min)	Material
				psi	bar	MPa		
104266		1/2(f)	1/4(f)	0-250	0-17.2	0-1.72	90 (2.5)	Zinc-plated
	203716	1/2 90° swivel(f) x 3/8(m)						
	202858	1/2 swivel(f) x 3/8(f)						
	202156	1/2 x 3/8 bushing, gauge						
	223815	1/2 swivel, ball valve, gauge (also order nipple 162505)						
171937		1/2(f)	1/4(f)	0-250	0-17.2	0-1.72	90 (2.5)	Zinc-plated
104815		1/8(f)	1/8(f)	0-60	0-4.1	0-0.41	15 (0.4)	Zinc-plated
110318		1/4(f)	1/8(f)	0-180	0-12.4	0-1.24	15 (0.4)	Zinc-plated
	110147	1/4(f)						
110341		1/8(f)	1/8(f)	0-125	0-8.6	0-0.86	39 (1.1)	Zinc-plated
111804		1/4(f)	1/8(f)	0-125	0-8.6	0-0.86	39 (1.1)	Zinc-plated
104267		1/2(f)	1/4(f)	0-125	0-8.6	0-0.86	90 (2.5)	Zinc-plated
	206237	1/2 npsm(f) x 3/8 ball valve(m)						
171937		1/2(f)	1/4(f)	0-125	0-8.6	0-0.86	90 (2.5)	Zinc-plated



Pressure Regulators



Precise fluid control is crucial to any finishing process. Graco has a proven line of fluid pressure regulators to meet all of your finishing needs. Our experience provides us unique insight in to the ideal fluid pressure regulator for a wide array of finishing applications and materials.

Fluid Regulator



Fluid pressure regulators control pressure of the downstream fluid, allowing operators to accurately control the pressure to guns, applicators and dispense valves. This ensures the process is stable and maintains the optimal conditions needed for a smooth paint finish, consistent extrusion or steady flow. Graco fluid regulators are designed with wear resistant materials for long life, even when using harsh materials. With decades of experience and continuous improvement, Graco has created some of the most reliable, high performance regulators in the industry.

Back Pressure Regulator

Control upstream fluid pressure with Graco back pressure regulators. Our back pressure regulators use closed loop control to maintain the pressure of the system regardless of flow demand. This allows operators to trigger guns, valves, and other flow controls without changing the system pressure.















Pressure Regulators Product Matrix

	Part Number	Max Pressure psi (bar)	Regulated Pressure psi (bar)	Max Delivery gpm (lpm)	Wetted Parts	Type	Inlet/Outlet	Gauge Port	Includes Gauge
Low Pressure 0-160 psi (0-11 bar)	 24E472	1-30 (0.06-2.0)			SST	Air	1/4 M 1/4 F		
	24E471	1-50 (0.06-3.4)			SST	Air	1/4 M 1/4 F		
	24C375	1-90 (0.06-6.2)			SST	Air	1/4 M 1/4 F		
	 236449	100 (7)	3-30 (0.2-2)	0.5 (1.9)	Acetal	Manual	1/4 F 1/4 F	1/4 F	Yes
	241976	100 (7)	3-30 (0.2-2)	0.5 (1.9)	Acetal	Manual	1/4 F 1/4 F	1/4 F	No
	236281	100 (7)	3-100 (0.2-7)	0.5 (1.9)	Acetal	Air	1/4 F 1/4 M	1/4 F	Yes
	236216	100 (7)	20-100 (1-7)	0.5 (1.9)	Acetal	Manual	1/4 F 1/4 F	1/4 F	Yes
	236450	100 (7)	20-100 (1-7)	0.5 (1.9)	Acetal	Manual	1/4 F 1/4 F	1/4 F	Yes
	 214980	250 (17.5)	0-30 (0-2)	3.0 (11.3)	SST	Air	3/8 F 3/8 F	1/4 F	No
	214895	250 (17.5)	5-100 (0-7)	3.0 (11.3)	SST	Manual	3/8 F 3/8 F	1/4 F	No
	214706	250 (17.5)	5-100 (0-7)	3.0 (11.3)	SST	Manual	3/8 F 3/8 F	1/4 F	Yes
	222115	250 (17.5)	20-160 (1-11)	3.0 (11.3)	SST	Manual	3/8 F 3/8 F	1/4 F	Yes
	217314	250 (17.5)	20-160 (1-11)	3.0 (11.3)	SST	Manual	3/8 F 3/8 F	1/4 F	Yes
	221118	250 (17.5)	20-160 (1-11)	3.0 (11.3)	SST	Manual	3/8 F 3/8 F	1/4 F	Yes
	 830351	250 (17.5)	3-100 (0.2-7)	3.0 (11.3)	SS	Air	3/8 F 1/4 F	None	No
	830352	250 (17.5)	3-100 (0.2-7)	3.0 (11.3)	SS	Air	3/8 F 1/4 F	None	No
	830353	250 (17.5)	3-100 (0.2-7)	3.0 (11.3)	SS	Air	3/8 F 1/4 F	None	No
	 234272	580 (40)	6-145 (0.4-10)	7.0 (26.4)	SS	Air	3/8 F 3/8 F	1/8 BSPP	No
234256	580 (40)	6-145 (0.4-10)	7.0 (26.4)	SS	Air	3/8 F 3/8 F	1/8 BSPP	No	
234273	580 (40)	15-145 (1-10)	7.0 (26.4)	SS	Spring	3/8 F 3/8 F	1/8 BSPP	No	
234263	580 (40)	15-290 (1-20)	7.0 (26.4)	SS	Spring	3/8 F 3/8 F	1/8 BSPP	No	
 234267	1015 (70)	145-725 (10-50)	9.8 (37)	SS	Spring	3/8 F 3/8 F	1/8 BSPP	No	
High Pressure 150-5000 psi (10-344 bar)	 222121	1500 (103)	150-1200 (10-83)	1.0 (3.7)	SST	Manual	1/4 F 1/4 F	-	No
	240197	1500 (103)	150-1200 (10-83)	1.0 (3.7)	SST	Manual	1/4 F 1/4 F	1/4 F	Yes
	240198	1500 (103)	150-1200 (10-83)	1.0 (3.7)	SST	Manual	1/4 F 1/4 F	1/4 F	Yes
	 217576	3000 (206)	200-1000 (13-69)	3.5 (13.2)	CS	Manual	3/8 F 1/4 F	1/4 F	Yes
	206661	3000 (206)	1000-3000 (69-206)	3.5 (13.2)	CS	Manual	3/8 F 3/8 F	1/4 F	No
	 238889	6000 (413)	500-3000 (34-206)	1.0 (3.7)	SST	Manual	3/8 F 3/8 F	1/4 F	Yes
	238890	6000 (413)	500-3000 (34-206)	1.0 (3.7)	SST	Manual	3/8 F 3/8 F	1/4 F	No
	238893	6000 (413)	500-4000 (34-275)	1.0 (3.7)	SST	Air	3/8 F 3/8 F	1/4 F	Yes
	238894	6000 (413)	500-4000 (34-275)	1.0 (3.7)	SST	Air	3/8 F 3/8 F	1/4 F	No
	 238891	6000 (413)	3000-5000 (206-344)	1.0 (3.7)	SST	Manual	3/8 F 3/8 F	1/4 F	Yes
238892	6000 (413)	3000-5000 (206-344)	1.0 (3.7)	SST	Manual	1-1/4 F 1-1/4 F	1/4 F	Yes	



Pressure Regulators Product Matrix

	Part Number	Max Pressure psi (bar)	Regulated Pressure psi (bar)	Max Delivery gpm (lpm)	Wetted Parts	Type	Inlet/Outlet	Gauge Port	Includes Gauge
High Pressure 150-5000 psi (10-344 bar)	 234266	5000 (344)	70-900 (5-62)	11.3 (42.7)	SS	Air	3/4 F 3/4 F	1/4 BSPP	No
	234270	5000 (344)	300-2000 (20-138)	11.7 (44.2)	SS	Air	3/4 F 3/4 F	1/4 BSPP	No
	234271	5000 (344)	600-4600 (41-317)	12.3 (46.5)	SS	Air	3/4 F 3/4 F	1/4 BSPP	No
	 234259	5000 (344)	600-3600 (41-248)	10.6 (40.1)	SS	Air	3/8 F 3/8 F	-	No
	 234260	2600 (179)	600-1500 (41-103)	8.1 (30.6)	SS	Spring	3/8 F 3/8 F	-	Yes
	 234264	6000 (413)	1300-3000 (90-206)	8.2 (31.0)	SS	Spring	3/8 F 3/8 F	-	No
 234265	6000 (413)	1300-4000 (90-275)	9.2 (34.8)	SS	Spring	3/8 F 3/8 F	-	Yes	
Back Pressure 0-250 psi (0-17 bar)	 208997	180 (12)	0-180 (0-12)	15 (56.7)	SST	Manual	1-1/4 F 1-1/4 F	1/4 F	Yes
	916154	180 (12)	0-180 (0-12)	15 (56.7)	SST, Carbide	Manual	1-1/4 F 1-1/4 F	1/4 F	Yes
	903508	180 (12)	0-180 (0-12)	15 (56.7)	SST	Manual	3/8 M 3/8 F	1/4 F	Yes
	 205122	180 (12)	0-180 (0-12)	2.0 (7.5)	CS	Manual	3/8 M 3/8 F	1/4 F	Yes
	237503	180 (12)	5-180 (0-12)	4.3 (16.2)	SST	Manual	3/8 M 3/8 F	1/4 F	No
	236770	180 (12)	5-180 (0-12)	4.3 (16.2)	SST	Manual	3/8 M 3/8 F	1/4 F	Yes
	 206019	180 (12)	0-180 (0-12)	15.0 (56.7)	Aluminum	Manual	1 F 1 F	1/4 F	Yes
	 224486	300 (20.7)	5-180 (0.3-12)	20 (75)	SST, Acetal and PTFE	Manual	1-1/2 F	1/4 npt(f)	Yes
	223824	300 (20.7)	5-180 (0.3-12)	20 (75)	SST, Acetal and PTFE	Manual	2 in Sanitary	1/3 npt(f)	Yes
	 288117	300 (20.7)	25-250 (1.7-17)	20 (75)	SST, Acetal and PTFE	Air	1-1/4 F	1/4 npt(f)	Yes
	288311	300 (20.7)	25-250 (1.7-17)	20 (75)	SST, Acetal and PTFE	Air	1-1/2 F	1/4 npt(f)	Yes
	288262	300 (20.7)	25-250 (1.7-17)	20 (75)	SST, Acetal and PTFE	Air	2 in Sanitary	1/4 npt(f)	Yes
	 234262	145 (10)	15-145 (1-10)	4.6 (17.4)	SS	Spring	3/8 F 3/8 F	1/8 BSPP	No
	234261	290 (20)	15-290 (1-20)	5.7 (21.5)	SS	Spring	3/8 F 3/8 F	1/8 BSPP	No
	234255	290 (20)	29-290 (2-20)	7.8 (29.5)	SS	Spring	3/8 F 3/8 F	1/8 BSPP	No
 234257	145 (10)	15-145 (1-10)	4.6 (17.4)	SS	Air	3/8 F 3/8 F	1/8 BSPP	No	
 234258	725 (50)	73-725 (5-50)	11.5 (43.5)	SS	Spring	3/8 F 3/8 F	1/8 BSPP	No	



Pressure Regulators

Low Pressure Fluid Pressure Regulator

- Stainless steel wetted materials are compatible with catalyst and waterborne materials
- Removable adjustment key eliminates operator interference
- Manual quick flush mode ensures easy cleaning without impacting production settings
- Air operated model (214980) provides easy automation opportunities
- Low shear model (222115) uses laminar diaphragm valve to reduce material degradation and color matching issues, especially with metallic paint
- Tungsten and carbide materials ensure low wear and long life
- PTFE/Elastomer hybrid diaphragm withstands wear while maintaining accurate responsiveness



Ordering Information

Part No.	Max Pressure psi (bar)	Regulated Pressure psi (bar)	Max Delivery gpm (lpm)	Max Viscosity in CPS	Wetted Parts	Type	Inlet/ Outlet	Gauge Port	Gauge Included
214980	250 (17.5)	0-30 (0-2)	3.0 (11.3)	1000	Tungsten carbide, acetal resins, PTFE, 304 & 316 SST, nylon, PET	Air	3/8 F 3/8 F	1/4 F	Yes
222115	250 (17.5)	20-160 (1-11)	3.0 (11.3)	300	SST	Spring	3/8 F 3/8 F	1/4 F	Yes
214895	250 (17.5)	5-100 (0-7)	3.0 (11.3)	1000	Tungsten carbide, acetal resins, PTFE, 304 & 316 SST, nylon, PET	Spring	3/8 F 3/8 F	1/4 F	No
214706	250 (17.5)	5-100 (0-7)	3.0 (11.3)	1000	Tungsten carbide, acetal resins, PTFE, 304 & 316 SST, nylon, PET	Spring	3/8 F 3/8 F	1/4 F	Yes
217314	250 (17.5)	20-160 (1-11)	3.0 (11.3)	1000	Tungsten carbide, acetal resins, PTFE, 304 & 316 SST, nylon, PET	Spring	3/8 F 3/8 F	1/4 F	Yes
221118	250 (17.5)	20-160 (1-11)	3.0 (11.3)	1000	Tungsten carbide, acetal resins, PTFE, 304 & 316 SST, nylon, PET	Spring	3/8 F 3/8 F	1/4 F	No

Instruction manual [307212](#)



Pressure Regulators

Low Pressure Lightweight Composite Fluid Pressure Regulator

- Lightweight composite material is compatible with waterborne materials
- PTFE, stainless steel seat, and carbide ball provide wear resistance
- Air operated model (241976) provides easy automation opportunities
- Pressure adjustment key with locking mechanism protects production settings



236449

Ordering Information

Part No.	Max Pressure psi (bar)	Regulated Pressure psi (bar)	Max Delivery gpm (lpm)	Max Viscosity in CPS	Wetted Parts	Type	Inlet/Outlet	Gauge Port	Gauge Included
236449	100 (7)	3-30 (0.2-2)	0.5 (1.9)	1000	Acetal	Spring	1/4 F 1/4 F	1/4 F	Yes
241976	100 (7)	3-30 (0.2-2)	0.5 (1.9)	1000	Acetal	Air	1/4 F 1/4 F	1/4 F	No
236281	100 (7)	3-100 (0.2-7)	0.5 (1.9)	1000	Acetal	Spring	1/4 F 1/4 M	1/4 F	Yes
236216	100 (7)	20-100 (1-7)	0.5 (1.9)	1000	Acetal	Spring	1/4 F 1/4 F	1/4 F	No
236450	100 (7)	20-100 (1-7)	0.5 (1.9)	1000	Acetal	Spring	1/4 F 1/4 F	1/4 F	Yes

Composite construction. Instruction manual [308325](#)



Pressure Regulators

Precision Flow

Fluid Pressure Regulator

- Spring-less fluid path reduces maintenance and internal material build up
- Stainless steel wetted materials are compatible with catalyst and waterborne materials
- Air operated control for easy automation integration
- High-flow bypass provides quick flushing capabilities without adjusting production settings
- Compact and lightweight design saves space and reduces payload for robot integration



Ordering Information

Part No.	Max Pressure psi (bar)	Regulated Pressure Ratio	Ratio Spacer	Wetted Parts	Type	Inlet/Outlet
24C375	1-90 (0.06-6.2)	1:1	Silver	SST	Air	1/4 M 1/8 F
24E471	1-50 (0.06-3.4)	1:2	Green	SST	Air	1/4 M 1/8 F
24E472	1-30 (0.06-2.0)	1:3	Black	SST	Air	1/4 M 1/8 F

Instruction manual [3A0427](#)

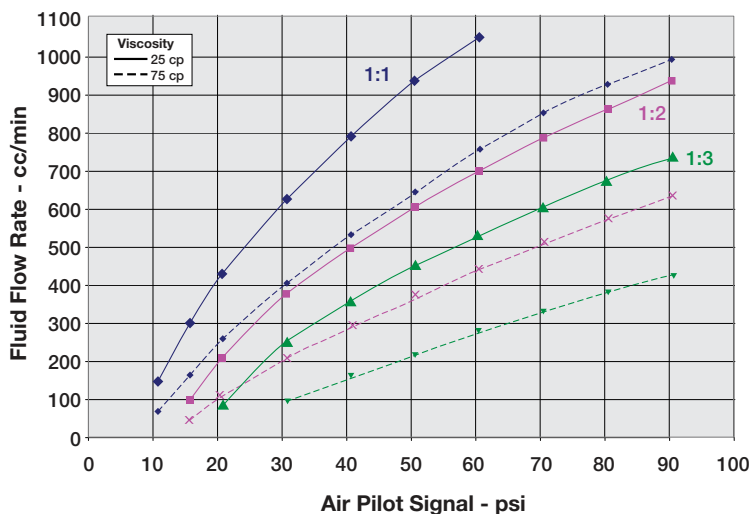

Test conditions: 90 psi fluid inlet, 1.0 mm nozzle, 10 ft 1/4 ID hose



Pressure Regulators

High Pressure Corrosion Resistant Fluid Pressure Regulator

- Stainless steel wetted materials are compatible with catalyst and waterborne materials
- Air operated model (241976) provides easy automation opportunities
- Tungsten and carbide materials ensure low wear and long life
- Valve cartridge for quick cleaning and replacement – reduce downtime
- Glycerin filled gauge for accurate pressure reading



238889



238893

Ordering Information

Part No.	Max Pressure psi (bar)	Regulated Pressure psi (bar)	Max Delivery gpm (lpm)	Max Viscosity in CPS	Wetted Parts	Type	Inlet/Outlet	Gauge Port	Gauge Included
238889	6000 (413)	500-3000 (34-206)	1.0 (3.7)	15000	SST	Spring	3/8 F 3/8 F	1/4 F	No
238890	6000 (413)	500-3000 (34-206)	1.0 (3.7)	15000	SST	Spring	3/8 F 3/8 F	1/4 F	Yes
238891	6000 (413)	3000-5000 (206-344)	1.0 (3.7)	15000	SST	Spring	3/8 F 3/8 F	1/4 F	No
238892	6000 (413)	3000-5000 (206-344)	1.0 (3.7)	15000	SST	Spring	3/8 F 3/8 F	1/4 F	Yes
238893	6000 (413)	500-4000 (34-275)	1.0 (3.7)	15,000	SST	Air	3/8 F 3/8 F	1/4 F	No
238894	6000 (413)	500-4000 (34-275)	1.0 (3.7)	15,000	SST	Air	3/8 F 3/8 F	1/4 F	Yes

Easy flush plug available. Instruction manual [308647](#).



Pressure Regulators

High Pressure Corrosion Resistant Mini Fluid Pressure Regulator

- Stainless steel wetted materials are compatible with catalyst and waterborne materials
- Pressure adjustment key with locking mechanism protects production settings
- Valve cartridge for quick cleaning and replacement – reduce downtime
- Compact and lightweight design saves space and reduces payload for spray packages
- Tungsten and carbide materials ensure low wear and long life



222121

Ordering Information

Part No.	Max Pressure psi (bar)	Regulated Pressure psi (bar)	Max Delivery gpm (lpm)	Max Viscosity in CPS	Wetted Parts	Type	Inlet/Outlet	Gauge Port	Gauge Included
222121	1500 (103)	150-1200 (10-83)	1.0 (3.7)	500	SST	Spring	1/4 F 1/4 F	–	No
240197	1500 (103)	150-1200 (10-83)	1.0 (3.7)	500	SST	Spring	1/4 F 1/4 F	1/4 F	Yes
240198	1500 (103)	150-1200 (10-83)	1.0 (3.7)	500	SST	Spring	1/4 F 1/4 F	1/4 F	Yes

Unique bottom replaceable cartridge. Instruction manual [307886](#).



Pressure Regulators

High Pressure Fluid Pressure Regulator

- Tungsten and carbide materials ensure low wear and long life
- Plated carbon steel housing is compatible with solvent-borne materials
- Laser-marked indication lines for easy pressure adjustment and process control
- Ergonomic adjustment knob



217576

Ordering Information

Part No.	Max Pressure psi (bar)	Regulated Pressure psi (bar)	Max Delivery gpm (lpm)	Max Viscosity in CPS	Wetted Parts	Type	Inlet/ Outlet	Gauge Port	Gauge Included
217576	3000 (206)	200-1000 (13-69)	3.5 (13.2)	500	CS	Spring	3/8 F 1/4 F	1/4 F	Yes
206661	3000 (206)	1000-3000 (69-206)	3.5 (13.2)	500	CS	Spring	3/8 F 1/4 F	1/4 F	Yes

Airless, solvent based systems. Instruction manual [306878](#).



Pressure Regulators

Low Pressure Corrosion Resistant Fluid Back Pressure Regulator (BPR)

- Stainless steel wetted materials are compatible with catalyst and waterborne materials
- Hardened stainless steel seat ensure low wear and long life
- PTFE/Elastomer hybrid diaphragm withstands wear while maintaining accurate responsiveness
- Large orifice accommodates high volume flow rates
- Air operated models available for automated control, Conversion kit (15J498)



208997

Ordering Information

Part No.	Max Pressure psi (bar)	Regulated Pressure psi (bar)	Max Delivery gpm (lpm)	Max Viscosity in CPS	Wetted Parts	Type	Inlet/Outlet	Gauge Port	Gauge Included
208997	180 (12)	0-180 (0-12)	15.0 (56.7)	1000	SST	Spring	1-1/4 F 1-1/4 F	1/4 F	Yes
916154	180 (12)	0-180 (0-12)	15.0 (56.7)	1000	SST, Carbide	Spring	1-1/4 F 1-1/4 F	1/4 F	Yes
903508	180 (12)	0-180 (0-12)	15.0 (56.7)	1000	SST	Spring	1 F 1-1/4 F	1/4 F	Yes

Instruction manual [307107](#).

Conversion kit 15J498 - converts a 208997 spring operated back pressure regulator to a pneumatic back pressure regulator.

Repair kit 15J820 - diaphragm repair kit with standard stainless steel seat.

Repair kit 15J822 - carbide repair kit for back pressure regulator.



Pressure Regulators

Low Pressure Mini Fluid Back Pressure Regulator (BPR)

- Stainless steel wetted materials are compatible with catalyst and waterborne materials
- Tungsten and carbide materials ensure low wear and long life
- Compact and lightweight design saves space and reduces payload for small circulation systems
- PTFE/Elastomer hybrid diaphragm withstands wear while maintaining accurate responsiveness
- Air operated model available for automated control, Conversion kit (237448)



205122

Ordering Information

Part No.	Max Pressure psi (bar)	Regulated Pressure psi (bar)	Max Delivery gpm (lpm)	Max Viscosity in CPS	Wetted Parts	Type	Inlet/Outlet	Gauge Port	Gauge Included
205122	180 (12)	0-180 (0-12)	2.0 (7.5)	1000	CS	Spring	3/8 M 3/8 F	1/4 F	Yes
237503	180 (12)	5-180 (0-12)	4.3 (16.2)	1000	SST	Spring	3/8 M 3/8 F	1/4 F	No
236770	180 (12)	5-180 (0-12)	4.3 (16.2)	1000	SST	Spring	3/8 M 3/8 F	1/4 F	Yes

Instruction manual [308401](#).



Pressure Regulators

Air Operated Corrosion Resistant Fluid Back Pressure Regulator (BPR)

- PTFE/Elastomer hybrid diaphragm withstands wear while maintaining accurate responsiveness
- Stainless steel wetted materials are compatible with catalyst and waterborne materials
- Hardened stainless steel seat ensure low wear and long life
- Large orifice accommodates high volume flow rates
- Air operated for remote automated control to eliminate operator interference
- Implement sleep mode to reduce pump energy consumption during non-production



288262

Ordering Information

Part No.	Max Pressure psi (bar)	Regulated Pressure psi (bar)	Max Delivery gpm (lpm)	Max Viscosity in CPS	Wetted Parts	Type	Inlet/Outlet	Gauge Port	Gauge Included
288117	300 (20.7)	25-250 (1.7-17)	20 (75)	1000	SST, Acetal and PTFE	Air	1-1/4 npt(f)	1/4 npt(f)	Yes
288311	300 (20.7)	25-250 (1.7-17)	20 (75)	1000	SST, Acetal and PTFE	Air	1-1/2 npt(f)	1/4 npt(f)	Yes
288262	300 (20.7)	25-250 (1.7-17)	20 (75)	1000	SST, Acetal and PTFE	Air	2 in Sanitary	1/4 npt(f)	Yes

Part Number	Description
15J498	Conversion kit - converts a 208997 spring operated back pressure regulator to a pneumatic back pressure regulator
15J820	Diaphragm repair kit with standard stainless steel seat
15J821	High-Flo diaphragm repair kit with standard stainless steel seat
15J822	Diaphragm repair kit with standard carbide seat

Instruction manual [311595](#).



Pressure Regulators

Low Shear Corrosion Resistant Fluid Back Pressure Regulator (BPR)

- Stainless steel membrane diaphragm is highly wear resistant while maintaining accurate responsiveness
- Low Shear diaphragm valve has minimal restriction to reduce material degradation and color matching issues, especially with metallic paint
- Stainless steel wetted materials are compatible with catalyst and waterborne materials
- Large fluid passages to accommodate high volume flow rates



223824

Ordering Information

Part No.	Max Pressure psi (bar)	Regulated Pressure psi (bar)	Max Delivery gpm (lpm)	Max Viscosity in CPS	Wetted Parts	Type	Inlet/Outlet	Gauge Port	Gauge Included
224486	300 (20.7)	5-180 (0.3-12)	20 (75)	1000	SST, Acetal and PTFE	Spring	1-1/2 F	1/4 F	Yes
223824	300 (20.7)	5-200 (0.3-13)	20(75)	1000	SST, Acetal and PTFE	Spring	2 in Sanitary	1/4 F	Yes

Instruction manual [308115](#).



Pressure Regulators

Low Pressure

Fluid Back Pressure Regulator (BPR)

- Electroless nickel plated aluminum housing with smooth flow orifices
- Tungsten and carbide materials to resist wear
- PTFE/Elastomer hybrid diaphragm withstands wear while maintaining accurate responsiveness
- Compatible with solvent-borne materials



206019

Ordering Information

Part No.	Max Pressure psi (bar)	Regulated Pressure psi (bar)	Max Delivery gpm (lpm)	Max Viscosity in CPS	Wetted Parts	Type	Inlet/Outlet	Gauge Port	Gauge Included
206019	180 (12)	0-180 (0-12)	15.0 (56.7)	1000	Alum	Spring	1 F 1 F	1/4 F	Yes

Instruction manual [306770](#).



Pressure Regulators

High Pressure

Fluid Back Pressure Regulator (BPR)

- Tungsten and carbide materials ensure low wear and long life
- Plated carbon steel housing is compatible with solvent-borne materials
- Laser-marked indication lines for easy pressure adjustment and process control
- Ergonomic adjustment knob



Ordering Information

Part No.	Max Pressure psi (bar)	Regulated Pressure psi (bar)	Max Delivery gpm (lpm)	Max Viscosity in CPS	Wetted Parts	Type	Inlet/Outlet	Gauge Port	Gauge Included
222405	3000 (207)	0 - 1000 (0 - 70)	3.5 (13.3)	500	CS	Spring	1/4 F 1/4 F	1/4 F	No
206819	3000 (207)	1000 - 3000 (70 - 207)	3.5 (13.3)	500	CS	Spring	1/4 F 1/4 F	1/4 F	No
238926	3000 (207)	1000 - 3000 (70 - 207)	3.5 (13.3)	500	SST	Spring	1/4 F 1/4 F	1/4 F	No

High pressure, solvent coatings. Instruction manual [306860](#).

Part No.	Max Pressure psi (bar)	Regulated Pressure psi (bar)	Max Delivery gpm (lpm)	Max Viscosity in CPS	Wetted Parts	Type	Inlet/Outlet	Gauge Port	Gauge Included
234268	2500 (172)	600 - 1500 (41 - 103)	10.2 (38.6)	–	SS	Spring	3/8 F	–	No
234269	3400 (234)	1300 - 3000 (89 - 207)	13.1 (49.5)	–	SS	Spring	3/8 F	–	No

Solvent/water based. Instruction manual [309475](#).



Gun Controls and Adapters

Gun-Mounted Fluid Regulators

Gun-Mounted Regulator

- Stainless steel materials are compatible with catalyst and waterborne materials
- Easy and accurate pressure adjustment at the gun to fine tune pressure settings during production
- Connects quickly to spray guns using twistlock connector
- Circulate materials through the regulator to ensure a uniform fluid suspension and eliminate material stagnation



223621

223622

Ordering Information

Part No.	Inlet/ Outlet	Max. Inbound Fluid			Regulated Pressure			Wetted Parts
		psi	bar	MPa	psi	bar	MPa	
223621	3/8 twistlock	200	14	1.4	5-35	0.3-2.4	0.03-0.24	SST

Note: 3/8 twistlock outlet to gun. Regulator to gun fitting 223628 twistlock. Instruction manual [307016](#).

Part No.	Inlet/ Outlet	Max. Inbound Fluid			Regulated Pressure			Wetted Parts
		psi	bar	MPa	psi	bar	MPa	
208082	1/4 npsm(m)	200	14	1.4	5-35	0.3-2.4	0.03-0.24	SST

Note: 208085 regulator to gun fitting. Instruction manual [307016](#).

Part No.	Inlet/ Outlet	Max. Inbound Fluid			Regulated Pressure			Wetted Parts
		psi	bar	MPa	psi	bar	MPa	
223622	3/8 npsm(f)	200	14	1.4	5-35	0.3-2.4	0.03-0.24	SST

Note: Regulator to gun fitting 223628 twistlock. Direct to gun fitting. Instruction manual [307016](#).

Part No.	Inlet/ Outlet	Max. Inbound Fluid			Regulated Pressure			Wetted Parts
		psi	bar	MPa	psi	bar	MPa	
223623	3/8 twistlock	200	14	1.4	5-35	0.3-2.4	0.03-0.24	SST

Note: Regulator to gun fitting 223628 twistlock. Instruction manual [307016](#).



Gun Controls and Adapters

Fluid Restrictor Valves

Tamper-Resistant Valves

- Manually adjust flow settings at the gun
- Tamper resistant adjustment knob to eliminate operator interference
- Circulate materials through the valve to ensure a uniform fluid suspension and eliminate material stagnation
- Stainless steel materials are compatible with catalyst and waterborne materials



223617



223619

Ordering Information

Part No.	Inlet/ Outlet	Max. Inbound Fluid			Wetted Parts
		psi	bar	MPa	
223617	1/4 npsm(m)	300	21	2.1	SST

Note: 3/8 twistlock outlet to gun. Valve to gun fitting 223628 twistlock.
Instruction manual [307751](#).

Part No.	Inlet/ Outlet	Max. Inbound Fluid			Wetted Parts
		psi	bar	MPa	
223618	3/8 npsm(m)	300	21	2.1	SST

Instruction manual [307751](#).

Part No.	Inlet/ Outlet	Max. Inbound Fluid			Wetted Parts
		psi	bar	MPa	
223619	1/4 npsm(m)	300	21	2.1	SST

Note: 3/8 npsm(f) swivel. Instruction manual [307751](#).

Part No.	Inlet/ Outlet	Max. Inbound Fluid			Wetted Parts
		psi	bar	MPa	
223620	3/8 npsm(m)	300	21	2.1	SST

Note: 3/8 npsm(f) coupler. Instruction manual [307751](#).

Note: Restrictor valves require tool 220102 to adjust.



Gun Controls and Adapters

Fluid Adaptors

Gun Fittings

- Stainless steel construction
- Quick couplers automatically seal once disconnected
- Quickly change between guns, regulators, and lines to reduce setup, changeover, and maintenance time
- Don't flush through guns tips, disconnect and flush through quick connects. Reduce flushing time and avoid premature tip wear.
- Provide flexibility for operators, especially those that own or maintain their own guns. Promote daily maintenance.
- Compatible with Graco Gun Regulators and Restrictors



Ordering Information

Part No.	Inlet/Outlet	Maximum WPR			Inlet & Return Ports	Outlet	Material	Manual
		psi	bar	MPa				
• 223627	Coupler stem	200	14	1.4	Twistlock (m)	3/8 npsm (f)	SST	307016
• 223624	Straight adapter	200	14	1.4	3/8 npsm (m)	Twistlock (f)	SST	307016
• 223625	Straight adapter	300	20.7	2.07	3/8 npsm (m)	Twistlock (f)	SST	307016
• 223628	Coupler stem	300	20.7	2.07	Twistlock (m)	3/8 npsm (f)	SST	307016



Surge Suppressors



Surge Suppressors are a simple and reliable way to reduce pulsation and assure smooth fluid transfer throughout your finishing system. Graco surge suppressors were designed specifically for the finishing industry from decades of pump technology research. The streamlined fluid path ensures low shear, smooth fluid flow, and superior flush ability.



Surge Suppressors

High Flow Surge Suppressors

- Reduces pulsation for consistent material delivery and uniform spray pattern
- Stainless steel and PTFE materials are compatible with many finishing materials
- In-line flow configuration is easy to flush, making color changes quick and easy
- Multiple fluid connection options accommodate global system requirements
- Ideal for large, high flow rate systems



238986

Ordering Information

Part No.	Description	Inlet/ Outlet npt	Maximum WPR			Max. Delivery		Material	Manual
			psi	bar	MPa	gpm	lpm		
238986	Surge Tank	2	300	21	2.1	20	76	SST, PTFE	307707
238987	High-Flo Surge Tank	2*	300	21	2.1	20	76	SST, PTFE	307707
238988	High-Flo Surge Tank	1-1/2*	300	21	2.1	20	76	SST, PTFE	307707
218509	High-Flo Surge Tank	2*	600	42	4.2	20	76	Carbide, SST UHMWPE, Viton PTFE	307707

*Sanitary Tri-Clamp compatible

Note: Maximum flow rates are recommended maximums for peak performance. Exceeding these values reduces the surge tanks ability to dampen pulsation.



Surge Suppressors

In-line Surge Suppressor

- Stainless steel and PTFE materials are compatible with many finishing materials
- Reduces pulsation for consistent material delivery and uniform spray pattern
- In-line flow configuration is easy to flush, making color changes quick and easy



220157

Ordering Information

Part No.	Inlet/ Outlet npt	Maximum Inbound Fluid			Max. Delivery		Wetted Parts	Manual
		psi	bar	MPa	gpm	lpm		
220157	1 x 1-1/4 npt(f)	600	42	4.2	15	57	Carbine, SST, UHMWPE, Viton, PTFE	307707



Surge Suppressors

Tee Surge Suppressor

- Stainless steel and PTFE materials are compatible with many finishing materials
- Reduces pulsation for consistent material delivery and uniform spray pattern
- Isolate the surge tank and perform on-line maintenance with tee configuration



233736

Ordering Information

Part No.	Inlet/ Outlet npt	Maximum Inbound Fluid			Wetted Parts	Manual
		psi	bar	MPa		
• 233736	3/4 BSPP(f)	360	25	2.5	SST, PTFE	307707

- Waterborne compatible



Filters



Safe guard your process by removing contaminants from your circulation line. Graco has a high quality filter solution for a wide range of pressure and flow rates.

Bag Filter

Bag filters are a great solution for filtering high volumes of liquid. They are simple, economical, and effective. This filter works well in conjunction with any of our high quality, high volume pumps. Graco's high capacity filters extend the time between filter changes which is ideal for large circulation systems in which downtime is not an option.

Red Alert

Red Alert filters are a unique filtering option. The integrated Red Alert Pop Up Indicator signals the user that it is time to change the filter. This minimizes operator error and the need for check sheets or maintenance schedules. It also keeps filters from clogging and ensures your operation runs more efficiently.

High Pressure

Graco's high pressure filter is ideal for high or low pressure finishing applications to reduce material usage during flushing to save you money. The design also resists wear and damage from even the most corrosive and abrasive materials. Whether used on a spray package, a 2K catalyst system or circulation out-feed, this versatile filter won't let you down.



Filters

Stainless Steel High Pressure Filter

Filters

- Compatible with catalyst and waterborne materials
- Many porting options for different gauge, drain valve, and fluid line options
- Compact size is ideal for spray packages



223160

Ordering Information

Part No.	Description	Area/sq.		Mesh	Inlet/ Outlet npt	Maximum WPR			Material	Manual
		in	cm			psi	bar	MPa		
• 223160	Filter assembly	18	116	60	3/8(f) 1/4(m)	5000	345	34.5	304, 316 SST	307273
• 239800	Filter assembly	18	116	100	3/8(f) 1/4(m)	5000	345	34.5	304, 316 SST	307273
• 238782	Filter assembly for high solids material	18	116	30	3/8(f) outlets: 3/8, 1/4, 1/4 bottom: 1/4	5000	345	34.5	304, 316 SST	308611
240183		18	116	60	1/2(f) x 1/2(f)	5000	345	34.5	304 SST	307273

Replacement Screen Elements

25-Count Carton Part No.	2-Pack Part No.	Area/sq.		Mesh	Material
		in	cm		
• 238436	224458	18	116	30	SST
• 238438	224459	18	116	60	SST
• 238440	224468	18	116	100	SST
• 238442	224469	18	116	200	SST



Filters

High Pressure Red Alert Filter

Filters

- Red Alert indicator signals filter element replacement to ensure efficient filtration
- Large flow capacity is ideal for large circulation and supply systems
- Integrated mounting holes make installation to frame and equipment easy
- Bottom port for installing quick flush ball valve



210090

Ordering Information

Part No.	Area/sq.		Mesh	Inlet/ Outlet npt	Maximum WPR			Max. Delivery		Material of Construction	Manual
	in	cm			psi	bar	MPa	gpm	lpm		
210090	36	232	60	3/4	3000	207	20.7	10	38	CS, glass sight and FKM o-rings	307252
210091	36	232	100	3/4	3000	207	20.7	10	38	CS, glass sight and FKM o-rings	307252
210092	36	232	200	3/4	3000	207	20.7	10	38	CS, glass sight and FKM o-rings	307252
207994	225	1451	30	1-1/4	3000	207	20.7	20	75	CS, glass sight and FKM o-rings	306987
207995	225	1451	60	1-1/4	3000	207	20.7	20	75	CS, glass sight and FKM o-rings	306987
207996	225	1451	100	1-1/4	3000	207	20.7	20	75	CS, glass sight and FKM o-rings	306987
207997	225	1451	150	1-1/4	3000	207	20.7	20	75	CS, glass sight and FKM o-rings	306987
207998	225	1451	200	1-1/4	3000	207	20.7	20	75	CS, glass sight and FKM o-rings	306987
207999	225	1451	.040 stab pt.*	1-1/4	3000	207	20.7	20	75	CS, glass sight and FKM o-rings	306987
208000	225	1451	.050 stab pt.*	1-1/4	3000	207	20.7	20	75	CS, glass sight and FKM o-rings	306987



Filters

Low Pressure Red Alert Filter

Filters

- Red Alert indicator signals filter element replacement to ensure efficient filtration
- Large flow capacity is ideal for large circulation and supply systems
- Bottom port for installing quick flush ball valve



213058

Ordering Information

Part No.	Assembly	Area/sq.		Mesh	Inlet/ Outlet	Max WPR			Max Delivery		Material	Manual
		in	cm			psi	bar	MPa	gpm	lpm		
213057	Complete	36	232	30	3/4 npt	300	21	2.1	6	22	Aluminum, glass sight and FKM o-rings	307282
213058	Complete	36	232	60	3/4 npt	300	21	2.1	6	22	Aluminum, glass sight and FKM o-rings	307282
213059	Complete	36	232	100	3/4 npt	300	21	2.1	6	22	Aluminum, glass sight and FKM o-rings	307282
213060	Complete	36	232	150	3/4 npt	300	21	2.1	6	22	Aluminum, glass sight and FKM o-rings	307282
213061	Complete	36	232	200	3/4 npt	300	21	2.1	6	22	Aluminum, glass sight and FKM o-rings	307282
213062	Complete	225	1451	30	1-1/4 npt	300	21	2.1	20	76	Aluminum, glass sight and FKM o-rings	307283
213063	Complete	225	1451	60	1-1/4 npt	300	21	2.1	20	76	Aluminum, glass sight and FKM o-rings	307283
213064	Complete	225	1451	100	1-1/4 npt	300	21	2.1	20	76	Aluminum, glass sight and FKM o-rings	307283
213065	Complete	225	1451	150	1-1/4 npt	300	21	2.1	20	76	Aluminum, glass sight and FKM o-rings	307283
213066	Complete	225	1451	200	1-1/4 npt	300	21	2.1	20	76	Aluminum, glass sight and FKM o-rings	307283



Filters

Model 6 Bag Filter Housing

Filters

- High flow capacity ideal for large circulation systems
- Easy to replace bag filters are inexpensive and effective at filtering many types of media
- Flexible filter options make it easy to fine tune your filtration system
- Standard filter assembly includes housing, cover, cover o-ring and unlined stainless steel basket
- Order filter bags separately



915515

Ordering Information

Part No.	Description	Inlet/ Outlet	Maximum WPR			Max. Delivery		Material
			psi	bar	MPa	gpm	lpm	
915515	Model 6 (0.5 sq ft filter area)	1-1/4 npt	300	21	2.1	15	57	CS
• 915516	Model 6 (0.5 sq ft filter area)	1-1/4 npt	300	21	2.1	15	57	SST

- Waterborne compatible

Part Number	Description
521268	Stainless steel strainer basket, perforated
521276	Stainless steel strainer basket, perforated with 100 mesh liner
521306	Replacement eye-bolt and nut
521691	Replacement o-ring

Instruction manual: [311775](#)



Filters

Model 6 Bag Filter Elements

Filters

- Many mesh sizes available to meet you exact filtration needs
- Polypropylene rim top uses fluid pressure to improve sealing force
- Stainless steel rim top uses friction to seal



Poly Rim Top

Ordering Information

Micron	Polypropylene Rim Top	SST Ring Top	Compatible Filter Housings
5	16K497	521226	915515 915516
10	16K498	521227	
25	16K499	521228	
50	16K500	521229	
75	16K501	521230	
100	16K502	521231	
125	16K503	521232	
150	16K504	521233	
200	16K505	521234	
250	16K506	521235	
300	16K507	521236	

Replacement Filters Bags

Part Number	Material	Micron Size
521311	Glazed polyester felt without cover	5
521177	Glazed polyester felt encased in spun bonded nylon cover	25
521180		100
521335	Glazed polyester felt encased in nylon mono-filament mesh cover.	50
521336		75
521337		100
521226	Nylon monofilament mesh.	5
521227		10
521228		25
521229		50
521230		75
521231		100
521232		125
521233		150
521234		200
521235		250
521236	300	



Filters

Model 12 Bag Filter Housings

Filters

- High flow capacity ideal for large circulation systems
- Easy to replace bag filters are inexpensive and effective at filtering many types of media
- Flexible filter options make it easy to fine tune your filtration system
- Standard filter assembly includes housing, cover, cover o-ring and unlined stainless steel basket
- Order filter bags separately



916367

Ordering Information

Part No.	Description	Inlet/ Outlet	Maximum WPR			Max. Delivery		Material
			psi	bar	MPa	gpm	lpm	
915517	Model 12 (1.0 sq ft filter area)	1-1/2 npt	500	21	2.1	30	114	CS
• 915518	Model 12 (1.0 sq ft filter area)	1-1/2 npt	500	21	2.1	30	114	SST
• 916367	Model 12 (sanitary with Poly Lok)	1-1/2 sanitary	500	35	3.5	30	114	SST

- Waterborne compatible

Part Number	Description
521276	Stainless steel strainer basket, perforated
521280	Stainless steel strainer basket, perforated with 100 mesh liner
521306	Replacement eye-bolt and nut
521691	Replacement o-ring

Instruction manual: [311775](#)



Filters

Model 12 Bag Filter Elements

Filters

- Many mesh sizes available to meet you exact filtration needs
- Polypropylene rim top uses fluid pressure to improve sealing force
- Stainless steel rim top uses friction to seal



Poly Rim Top

Ordering Information

Micron	Polypropylene Rim Top	SST Ring Top	Compatible Filter Housings
5	16K510	521254	915517 915518
10	16K511	521255	
25	16K512	521256	
50	16K513	521257	
75	16K514	521258	
100	16K515	521259	
125	16K516	521260	
150	16K517	521261	
200	16K518	521262	
250	16K519	521263	
300	16K520	521264	

Replacement Filters

Part Number	Material	Micron Size
521183	Glazed polyester felt encased in spun bonded nylon cover	5
521184		10
521189		100
521342	Glazed polyester felt encased in nylon mono-filament mesh cover.	10
521344		25
521347		100
521254	Nylon monofilament mesh.	5
521255		10
521256		25
521257		50
521258		75
521259		100
521260		125
521261		150
521262		200
521263		250
521264		300



Hoses, Fittings, Swivels and Gauges



Hoses, Fittings, Swivels and Gauges

The key to a productivity is a complete system with hoses, fittings, swivels and gauges. Our gauges, fittings and hoses have options for both air and fluids, and our material selections cater to the needs of the finishing industry. They handle tough solvents, moisture sensitive or corrosive acid catalysts. They withstand the harshest environments and minimize downtime.



Hoses, Fittings, Swivels and Gauges

Bulk Hose and Fittings

Nylon Fluid Hose

- Nylon tube
- Compatible with catalyst and waterborne materials
- Order 500 ft (152 m) increments



2-piece Reusable Hose Fittings

- Compatible with catalyst and waterborne materials
- Easily create custom fluid hoses



Part No.	Size and Pressure	No Spring Guard		No Spring Guard		Spring Guard	
		1/8 in NPT(M)	1/4 in NPT(M)	1/4 in NPSM(F)	3/8 in NPSM(F)	1/4 in NPSM(F)	3/8 in NPSM(F)
061135	1/8 in ID – 475 psi (33 bar)	205436		206020			
061132	1/4 in ID – 225 psi (16 bar)	205437		205447	205448	111913	111914
061134	3/8 in ID – 200 psi (14 bar)				205439		



Hoses, Fittings, Swivels and Gauges

Bulk Hose and Fittings

Braided Fluid Hose

- Nylon braided hose
- Neoprene cover
- Compatible with catalyst and waterborne materials
- Order 500 ft (152 m) increments



3-piece Reusable Hose Fittings

- Easily create custom fluid hoses
- Three piece threaded design
- Fittings can be reused



Part No.	Size and Pressure	3 piece couplers		2 piece couplers	
		1/4 in NPSM(F)	3/8 in NPSM(F)	1/4 in NPSM(F)	3/8 in NPSM(F)
061205	1/4 in ID – 500 psi (35 bar)	104415	104084	16A989	16A990
061195	3/8 in ID – 300 psi (21 bar)		104414	16A992	16A993
061200	1/2 in ID – 500 psi (35 bar)				
061185	3/4 in ID – 500 psi (35 bar)				
061188	1 in ID – 500 psi (35 bar)				



Hoses, Fittings, Swivels and Gauges

Bulk Hose and Fittings

Flexible Air Hose

- PVC braided hose
- PVC cover
- Flexible hose allows easy movement and improved ergonomics
- Bulk ordering allows custom fabrication of specialized hoses
- Order 500 ft (152 m) increments



2-piece Reusable Hose Fittings

- Simple two piece threaded design
- Easily create custom fluid hoses



Part No.	Size and Pressure	2 piece couplers			
		1/4 in NPT(M)	1/4 in NPSM(F)	3/8 in NPSM(F)	1/2 in NPSM(F)
15E291	1/4 in ID – 300 psi (21 bar)		16A989	16A990	
15E292	5/16 in ID – 300 psi (21 bar)	16A997	15K920		
15E293	3/8 in ID – 300 psi (21 bar)		16A992	16A993	
15E294	1/2 in ID – 300 psi (21 bar)				16A995



Hoses, Fittings, Swivels and Gauges

Coupled Stainless Steel Hoses



- Compatible with moisture sensitive materials
- Many different sizes, lengths, pressures, and connections available
- Fully assembled, includes couplings
- PTFE hose with braided SST cover

Ordering Information

Part No.	Coupling Size/Type	Length	Maximum WPR			ID Size	Electrical Grounding	Tube Material	Braid No. Material	Cover Material	Cover Color	Bend Radius (in (cm))	Max. Temp. °F (°C)
			psi	bar	MPa								
205324	1/4 npsm(fbe)	12 in (0.3 m)	3000	210	21.0	1/4 in	Wire Braid	PTFE	1-Wire	SST	SST	2.0 (5)	200 (93)
206966	1/4 npsm(fbe)	19 in (0.48 m)	3000	210	21.0	1/4 in	Wire Braid	PTFE	1-Wire	SST	SST	2.0 (5)	200 (93)
205099	1/4 npsm(fbe)	30 in (0.76 m)	3000	210	21.0	1/4 in	Wire Braid	PTFE	1-Wire	SST	SST	2.0 (5)	200 (93)
205058	1/4 npsm(fbe)	6 ft (1.8 m)	3000	210	21.0	1/4 in	Wire Braid	PTFE	1-Wire	SST	SST	2.0 (5)	200 (93)
205349	1/4 npsm(fbe)	15 ft (4.5 m)	3000	210	21.0	1/4 in	Wire Braid	PTFE	1-Wire	SST	SST	2.0 (5)	200 (93)
204938	1/4 npsm(fbe)	25 ft (7.6 m)	3000	210	21.0	1/4 in	Wire Braid	PTFE	1-Wire	SST	SST	2.0 (5)	200 (93)
206024	1/4 npsm(fbe)	50 ft (15.2 m)	3000	210	21.0	1/4 in	Wire Braid	PTFE	1-Wire	SST	SST	2.0 (5)	200 (93)



Hoses, Fittings, Swivels and Gauges

Moisture-Lok

Hoses

- Compatible with moisture sensitive materials
- Designed specifically to prevent moisture permeation through hose lining
- Many different sizes, lengths, pressures, and connections available
- Fully assembled, includes couplings
- Ideal for use with plural component materials

Ordering Information

Part No.	Coupling Size/Type	Length	Maximum WPR			ID Size
			psi	bar	MPa	
947233	1/4 npsm(fbe)	3 ft (0.9 m)	2750	190	19.0	1/4 in (6 mm)
947076	1/4 npsm(fbe)	6 ft (1.8 m)	2750	190	19.0	1/4 in (6 mm)
947077	1/4 npsm(fbe)	10 ft (3 m)	2750	190	19.0	1/4 in (6 mm)
947078	1/4 npsm(fbe)	15 ft (4.6 m)	2750	190	19.0	1/4 in (6 mm)
947079	1/4 npsm(fbe)	25 ft (7.6 m)	2750	190	19.0	1/4 in (6 mm)
947080	1/4 npsm(fbe)	50 ft (15.2 m)	2750	190	19.0	1/4 in (6 mm)
947475	3/8 npt(mbe)	2 ft (0.6 m)	2250	160	16.0	3/8 in (10 mm)
947081	3/8 npt(mbe)	6 ft (1.8 m)	2250	160	16.0	3/8 in (10 mm)
947082	3/8 npt(mbe)	10 ft (3 m)	2250	160	16.0	3/8 in (10 mm)
947083	3/8 npt(mbe)	15 ft (4.6 m)	2250	160	16.0	3/8 in (10 mm)
947084	3/8 npt(mbe)	25 ft (7.6 m)	2250	160	16.0	3/8 in (10 mm)
947085	3/8 npt(mbe)	50 ft (15.2 m)	2250	160	16.0	3/8 in (10 mm)
947086	1/2 npt(mbe)	6 ft (1.8 m)	2000	140	14.0	1/2 in (13 mm)
947087	1/2 npt(mbe)	10 ft (3 m)	2000	140	14.0	1/2 in (13 mm)
947089	1/2 npt(mbe)	25 ft (7.6 m)	2000	140	14.0	1/2 in (13 mm)
947091	3/4 npt(mbe)	6 ft (1.8 m)	1500	103	10.3	3/4 in (19 mm)
947092	3/4 npt(mbe)	10 ft (3 m)	1500	103	10.3	3/4 in (19 mm)
947093	3/4 npt(mbe)	15 ft (4.6 m)	1500	103	10.3	3/4 in (19 mm)
947094	3/4 npt(mbe)	25 ft (7.6 m)	1500	103	10.3	3/4 in (19 mm)
947096	1 npt(mbe)	6 ft (1.8 m)	1500	103	10.3	1 in (25 mm)



Hoses, Fittings, Swivels and Gauges

High Pressure Swivels

Swivels and Valves

- Improve mobility and ergonomics with high pressure swivels
- Swivels provide added rotational flexibility while providing high quality sealing even at high pressures
- Inline and Z configurations available



189018



207948

Ordering Information

Part No.	Inlet/Outlet npt	Maximum WPR			Packings	Wetted Parts	Manual	Suggested Material*
		psi	bar	MPa				
204083	1/4 npt(m) 1/8 npt(f)	8000	551	55.1	Leather	Steel-plated	306708	Oil, Grease, Lubricants
204084	1/4 npt(m) 1/4 npt(f)	8000	551	55.1	Leather	Steel-plated	306708	Oil, Grease, Lubricants
214925	1/4 npsm(f) 3/8 npt(f)	5000	345	34.5	Leather	Steel-plated	306861	Oil, Grease, Lubricants
207946	1/2 npsm(f) 3/8 npt(f)	6000	413	41.3	Polyurethane	Steel-plated	307005	Oil, Grease, Lubricants, Solventborne Paint
207947	1/2 npt(f) 1/2 npt(m)	6000	413	41.3	Polyurethane	Steel-plated	307005	Oil, Grease, Lubricants, Solventborne Paint
214926	1/2 npsm(f) 3/8 npt(f)	5000	345	34.5	Leather	Steel-plated	306861	Oil, Grease, Lubricants
• 239394	1/4 npsm(m) 1/4 npsm(f) Includes: filter chamber and 100 mesh tip filter (205264)	7500	517	51.7	PTFE	SST		Paint
• 189018	1/4 npsm(m) 1/4 npsm(f)	7500	517	51.7	PTFE	SST		Paint & Catalyst
• Waterborne compatible								
207948 (Z-Type Swivel)	1/2 (m) 1/2 (f)	6000	413	41.3	Polyurethane	Steel-plated	307005	Oil, Grease, Lubricants, Solventborne Paint

Caution: Z-swivels to be used with non-abrasive fluids only.

*General suggestion only. Results may vary depending on chemical composition.



Hoses, Fittings, Swivels and Gauges

Automatic Spray Gun Valve

Swivels and Valves

- Automate your system with this robust pneumatically operated valve
- Mount easily to 1/2in (12.7mm) rod using built-in set screw
- Stainless steel wetted materials are compatible with catalyst, waterborne, and other finishing materials
- Easily install a wide variety of flat tips for many spraying options
- Adjustment knob for fine tuning your process



206660

Ordering Information

Part No.	Inlet/Outlet npt	Maximum WPR		
		psi	bar	MPa
206660	1/4 npt(m) 1/8 npt(f)	3000	517	51.7

Instruction manual: [306830](#)



Hoses, Fittings, Swivels and Gauges

Check Valves

Swivels and Valves

- Stainless steel and PTFE materials are compatible with catalyst, waterborne, and other finishing materials
- Prevent fluid leakage and backflow
- Compact and easy to install
- Improves pump performance
- Easily install a wide variety of flat tips for many spraying options



501867

Ordering Information

Part No.	Inlet/Outlet npt	Maximum WPR			Packings	Wetted Parts
		psi	bar	MPa		
• 501867*	1/4 x 1/4 npt(mbe)	3000	207	20.7	PTFE	303 SST
• 501684*	3/8 x 3/8 npt(mbe)	3000	207	20.7	PTFE	303 SST
• 501603*	1/2 x 1/2 npt(fbe)	3000	207	20.7	PTFE	303 SST

- Waterborne compatible

*501867, 501684 and 501603 are poppet style



Hoses, Fittings, Swivels and Gauges

Pressure Relief Valve

Swivels and Valves

- Automatically relieves system pressure at specified rating to protect your system from overpressure
- Stainless steel and PTFE materials are compatible with catalyst, waterborne, and other finishing materials
- Compact and easy to install
- Tungsten and carbide materials ensure low wear and long life



237073

Ordering Information

Part No.	Inlet/ Outlet npt 1/2 (m)	Relief Port 1/2 npt(m) 1/2 (m)	Maximum WPR			Relief "Cracking" Pressure			Packings	Wetted Parts	Manual
			psi	bar	MPa	psi	bar	MPa			
• 237060	1/2 (f) 1/2 (m)	1/2 npt(m)	475-575	33-40	3.3-4.0	750	52	5.2	PTFE	304 SST, tungsten carbide	308547
• 237061	1/2 (f) 1/2 (m)	1/2 npt(m)	950-1150	66-79	6.6-7.9	1500	103	10.3	PTFE	304 SST, tungsten carbide	308547
• 237112	1/2 (f) 1/2 (m)	1/2 npt(m)	1400-1800	97-124	9.7-12.4	2250	155	15.5	PTFE	304 SST, tungsten carbide	308547
• 237062	1/2 (f) 1/2 (m)	1/2 npt(m)	1800-2300	124-159	12.4-15.9	3000	207	20.7	PTFE	304 SST, tungsten carbide	308547
• 237073	1/2 (f) 1/2 (m)	1/2 npt(m)	2300-2900	159-200	15.9-20.0	3750	259	25.9	PTFE	304 SST, tungsten carbide	308547
• 237063	1/2 (f) 1/2 (m)	1/2 npt(m)	2900-3600	200-248	20.0-24.8	4500	310	31.0	PTFE	304 SST, tungsten carbide	308547
• 237074	1/2 (f) 1/2 (m)	1/2 npt(m)	3600-5000	248-345	24.8-34.5	6000	414	41.4	PTFE	304 SST, tungsten carbide	308547

- Waterborne compatible



Hoses, Fittings, Swivels and Gauges

Ball Valves

Swivels and Valves

- Stainless steel and PTFE materials are compatible with catalyst, waterborne, and other finishing materials
- Many different connection options to meet your specific needs
- 500 psi (35 bar) pressure ratio



Part No. Inlet/Outlet npt
237528 1/4" NPT(M) x
1/4" NPT(M)



Part No. Inlet/Outlet npt
237529 1/4" NPT(M) x
3/8" NPSM(M)



Part No. Inlet/Outlet npt
237530 3/8" NPT(M) x
1/4" NPT(M)



Part No. Inlet/Outlet npt
237531 3/8" NPT(M) x
3/8" NPT(M)



Part No. Inlet/Outlet npt
237532 3/8" NPT(F) x
3/8" NPT(F)



Part No. Inlet/Outlet npt
237533 3/8" NPSM(M) x
3/8" NPT(M)



Part No. Inlet/Outlet npt
237535 3/8" NPT(F) x
3/8" NPSM(M)



Part No. Inlet/Outlet npt
237536 3/8" OD Tube x 3/8"
NPSM(M)



Part No. Inlet/Outlet npt
237537 3/8" OD Tube x
3/8" OD Tube



Part No. Inlet/Outlet npt
237538 3/8" OD Tube x
3/8" NPT(M)



Part No. Inlet/Outlet npt
237539 3/8" OD Tube x
3/8" NPSM(M)



Part No. Inlet/Outlet npt
237540 1/2" OD Tube x
3/8" NPSM(M)



Part No. Inlet/Outlet npt
237541 1/2" OD Tube x
3/8" NPSM(M)



Part No. Inlet/Outlet npt
237542 3/8" OD Tube x
3/8" OD Tube

Instruction manual: [307628](#)



Hoses, Fittings, Swivels and Gauges

Pipe Fittings

Other Accessories

Bushing

Reducing, Standard & Expanding



Part No.	Male Thread	Female Thread
100030	1/4 npt	1/8 npt
100730	3/8 npt	1/8 npt
100176	3/8 npt	1/4 npt
159841	3/8 npt	1/4 npt
168160	3/8 npt	1/4 npt
100329	1/2 npt	1/8 npt
100206	1/2 npt	1/4 npt

Part No.	Male Thread	Female Thread
102022	1/2 npt	1/4 npt
100081	1/2 npt	3/8 npt
100615	3/4 npt	1/4 npt
100896	3/4 npt	1/2 npt
100380	1 npt	1/2 npt
158586	1 npt	3/4 npt

Street Elbow



Part No.	Male Thread	Female Thread
100840	1/4 npt	1/4 npt
155699	3/8 npt	3/8 npt
158683	1/2 npt	1/2 npt
176393	3/4 npt	3/4 npt

Pipe Adapters



Part No.	Male Thread	Female Thread
150171	1/8 npt	1/8 npt
159840	1/8 npt	1/4 npt
156580	1/8 npt	3/8 npt
150287	1/4 npt	3/8 npt

Part No.	Male Thread	Female Thread
159842	1/4 npt	1/2 npt
150286	3/8 npt	3/8 npt
156022	3/8 npt	1/2 npt
168595	1/2 npt	3/4 npt

Coupling

Standard



Part No.	Thread
100451	1/8 npt
100175	1/4 npt
162024	3/8 npt
158581	1/2 npt
100385	3/4 npt
100474	1 npt

Hex Nipple

Standard & Reducing

Part No.	Male Thread	Female Thread
151519	1/4 npt	1/8 npt
156971	1/4 npt	1/4 npt
156296	3/8 npt	1/8 npt
165198	3/8 npt	1/4 npt
156849	3/8 npt	3/8 npt
162449	1/2 npt	1/4 npt

Part No.	Male Thread	Female Thread
159239	1/2 npt	3/8 npt
158491	1/2 npt	1/2 npt
157191	3/4 npt	1/2 npt
175013	3/4 npt	3/4 npt
158555	1 npt	3/4 npt

Square

Head Plug



Part No.	Thread
111697	1/4 npt
100040	3/8 npt
100737	1/2 npt
104663	3/4 npt



Hoses, Fittings, Swivels and Gauges

Pipe Swivels

Other Accessories

Straight Swivel Adapter

Male x Female



Part No.	Rigid Thread	Swivel Thread	Part No.	Rigid Thread	Swivel Thread
208434	1/8 npt	1/4 npt	156684	1/2 npt	1/2 npt
156823	1/4 npt	1/4 npt	158256	1/2 npt	3/8 npt
157705	1/4 npt	3/8 npt	157785	3/4 npt	3/4 npt
155665	3/8 npt	3/8 npt	202965	1 npt	3/4 npt
162505	3/8 npt	1/2 npt	160022	1 npt	1 npt

90° Swivel Adapter

Female x Female



Part No.	Rigid Thread	Swivel Thread
157676	1/4 npt	1/4 npt
155677	3/8 npt	3/8 npt
159801	3/8 npt	1/2 npt
157416	1/2 npt	1/2 npt
156589	3/4 npt	3/4 npt

Straight Swivel Adapter

Female x Female



Part No.	Rigid Thread	Swivel Thread	Part No.	Rigid Thread	Swivel Thread
155570	1/4 npt	1/4 npt	161077	1/2 npt	3/8 npt
159153	3/8 npt	1/4 npt	155865	1/2 npt	1/2 npt
156173	3/8 npt	3/8 npt	156172	3/4 npt	3/4 npt
155653	1/2 npt	1/4 npt	158383	1 npt	1 npt

90° Swivel Adapter

Male x Female



Part No.	Rigid Thread	Swivel Thread
155541	1/4 npt	1/4 npt
155495	3/8 npt	1/4 npt
155494	3/8 npt	3/8 npt
217430	3/8 npt	1/2 npt
161037	1/2 npt	3/8 npt
155470	1/2 npt	1/2 npt
160327	3/4 npt	3/4 npt

45° Swivel Adapter

Male x Female



Part No.	Rigid Thread	Swivel Thread
161889	3/8 npt	3/8 npt
105281	3/4 npt	3/4 npt



Hoses, Fittings, Swivels and Gauges

Stainless Steel Fittings

Other Accessories

Nipple

Part No.	Fitting Conf.	Pipe or Hose/ Tube	Fitting Type	Swivel	JIC or 37° Flare	Pressure Rating	Type of Connection	First Connection	Second Connection	Overall Length in (cm)	Material
166421	Straight	Pipe	Nipple	No	No	7500 psi (516 bar)	npt(m) x npt(m)	npt - 1/4 npt	npt - 1/4 npt	1.38 (3.5)	416 SST
166469	Straight	Pipe	Nipple	No	No	6000 psi (413 bar)	npt(m) x npt(m)	npt - 3/8 npt	npt - 3/8 npt	1.50 (3.8)	416 SST
166846	Straight	Pipe	Adapter	No	No	7250 psi (499 bar)	npt(m) x nps(m)	npt - 1/4 npt	nps - 1/4 npsm	1.19 (3.0)	304 SST
171195	Straight	Pipe	Adapter	No	No	–	npt(m) x nps(m)	npt - 3/8 npt	nps - 3/8 npsm	1.31 (3.3)	303 SST

Reducing Nipple

Part No.	Fitting Conf.	Pipe or Hose/ Tube	Fitting Type	Swivel	JIC or 37° Flare	Pressure Rating	Type of Connection	First Connection	Second Connection	Overall Length in (cm)	Material
166863	Straight	Pipe	Nipple	No	No	5000 psi (344 bar)	npt(m) x npt(m)	npt - 3/8 npt	npt - 1/4 npt	1.31 (3.3)	303 SST
166443	Straight	Pipe	Nipple	No	No	7250 psi (499 bar)	npt(m) x npt(m)	npt - 3/4 npt	npt - 1/2 npt	1.75 (4.4)	303 SST



Hoses, Fittings, Swivels and Gauges

Stainless Steel Fittings

Other Accessories

45° Elbow

Part No.	Fitting Conf.	Pipe or Hose/ Tube	Fitting Type	Swivel	JIC or 37° Flare	Pressure Rating	Type of Connection	First Connection	Second Connection	Overall Length in (cm)	Material
209029	Elbow	Pipe	45°	Yes	No	4600 psi (316 bar)	npt(m) x nps(f)	npt - 3/8 npt	nps - 3/8 npsm	1.06 x 1.25 (2.6 x 3.1)	303 SST

90° Elbow

Part No.	Fitting Conf.	Pipe or Hose/ Tube	Fitting Type	Swivel	JIC or 37° Flare	Pressure Rating	Type of Connection	First Connection	Second Connection	Overall Length in (cm)	Material
102325	Elbow	Pipe	90°	No	No	–	npt(f) x npt(f)	npt - 3/4 npt	npt - 3/4 npt	–	304 SST
110756	Elbow	Pipe	90°	No	No	150 psi (10 bar)	npt(m) x npt(m)	npt - 3/8 npt	npt - 3/8 npt	–	304 SST
207123	Elbow	Pipe	90°	Yes	No	5000 psi (344 psi)	npt(m) x nps(f)	npt - 3/8 npt	nps - 3/8 npsm	1.06 x 1.91 (2.6 x 4.8)	303 SST

90° Street Elbow

Part No.	Fitting Conf.	Pipe or Hose/ Tube	Fitting Type	Swivel	JIC or 37° Flare	Pressure Rating	Type of Connection	First Connection	Second Connection	Overall Length in (cm)	Material
166242	Elbow	Pipe	90°	No	No	4500	npt(m) x npt(f)	npt - 1/2 npt	npt - 1/2 npt	2.09 (5.3)	303 SST
166866	Elbow	Pipe	90°	No	No	9000	npt(m) x npt(f)	npt - 1/4 npt	npt - 1/4 npt	1.34 (3.4)	304 SST
515723	Elbow	Pipe	90°	No	No	150	npt(m) x npt(f)	npt - 1 npt	npt - 1 npt	–	304 SST



Hoses, Fittings, Swivels and Gauges

Stainless Steel Fittings

Other Accessories

Adapter

Part No.	Fitting Conf.	Pipe or Hose/ Tube	Fitting Type	Swivel	JIC or 37° Flare	Pressure Rating	Type of Connection	First Connection	Second Connection	Overall Length in (cm)	Material
119226	Straight	Pipe	Bushing	No	No	—	npt(m) x npt(f)	npt - 1/4 npt	npt - 1/4 npt	1.39 (3.5)	316 SST
114499	Straight	Pipe	Bushing	No	No	5000 psi (344 bar)	npt(m) x npt(f)	npt - 1/2 npt	npt - 1/2 npt	1.78 (4.5)	304/316 SST

Reducing Adapter

Part No.	Fitting Conf.	Pipe or Hose/ Tube	Fitting Type	Swivel	JIC or 37° Flare	Pressure Rating	Type of Connection	First Connection	Second Connection	Overall Length in (cm)	Material
512351	Straight	Pipe	Bushing	No	No	5000 psi (344 bar)	npt(m) x npt(f)	npt - 1/4 npt	npt - 3/8 npt	1.44 (3.6)	303 SST
121237	Straight	Pipe	Bushing	No	No	4000 (275 bar)	npt(m) x npt(f)	npt - 3/8 npt	npt - 1/2 npt	1.68 (4.2)	303 SST
121238	Straight	Pipe	Bushing	No	No	4000 (275 bar)	npt(m) x npt(f)	npt - 3/8 npt	npt - 3/4 npt	1.75 (4.4)	303 SST
16H491	Straight	Pipe	Adapter	No	No	5200 (358 bar)	npt(m) x npt(f)	npt - 1/4 npt	npt - 1/2 npt	1.69 (4.2)	SST
16J975	Straight	Pipe	Adapter	No	No	4300 (296 bar)	npt(m) x npt(f)	npt - 1/4 npt	npt - 3/4 npt	1.88 (4.7)	SST

Tee

Part No.	Fitting Conf.	Pipe or Hose/ Tube	Fitting Type	Swivel	JIC or 37° Flare	Pressure Rating	Type of Connection	First Connection	Second Connection	Third Connection	Overall Length in (cm)	Material
16C760	Tee	Pipe	Adapter	No	No	—	npt(m) x npt(m) x nps(m)	npt - 3/8 npt	npt - 1/4 npt	nps - 3/8 npsm	1.94 (4.9)	316 SST



Hoses, Fittings, Swivels and Gauges

Stainless Steel Fittings

Other Accessories

Bushing

Part No.	Fitting Conf.	Pipe or Hose/ Tube	Fitting Type	Swivel	JIC or 37° Flare	Pressure Rating	Type of Connection	First Connection	Second Connection	Overall Length in (cm)	Material
116350	Straight	Pipe	Bushing	No	No	150 psi (10 bar)	npt(m) x npt(f)	npt - 3/4 npt	npt - 3/8 npt	_	316 SST
502265	Straight	Pipe	Bushing	No	No	6000 psi (413 bar)	npt(m) x npt(f)	npt - 1/2 npt	npt - 3/8 npt	1.11 (2.8)	316 SST
502851	Straight	Pipe	Bushing	No	No	3000 (206 bar)	npt(m) x npt(f)	npt - 1 npt	npt - 3/4 npt	1.00 (2.5)	316 SST
16C475	Straight	Pipe	Bushing	No	No	6000 psi (413 bar)	npt(m) x npt(f)	npt - 3/4 npt	npt - 1/2 npt	1.17 (2.9)	304 SST

Coupling

Part No.	Fitting Conf.	Pipe or Hose/ Tube	Fitting Type	Swivel	JIC or 37° Flare	Pressure Rating	Type of Connection	First Connection	Second Connection	Overall Length in (cm)	Material
110336	Straight	Pipe	Coupling	No	No	5000 psi (344 bar)	npt(f) x npt(f)	npt - 1/4 npt	npt - 1/4 npt	1.13 (2.8)	316 SST

Socket Head Plug

Part No.	Fitting Conf.	Pipe or Hose/ Tube	Fitting Type	Swivel	JIC or 37° Flare	Pressure Rating	Type of Connection	First Connection	Second Connection	Overall Length in (cm)	Material
101748	Straight	Pipe	Plug - Socket Head	No	No	_	npt(m)	npt - 3/8 npt	_	0.46 (1.1)	304/316 SST
101970	Straight	Pipe	Plug - Socket Head	No	No	_	npt(m)	npt - 1/4 npt	_	0.41 (1.0)	300 Series SST
110208	Straight	Pipe	Plug - Socket Head	No	No	_	npt(m)	npt - 1/8 npt	_	0.25 (0.6)	304/316 SST



Hoses, Fittings, Swivels and Gauges

Stainless Steel Fittings

Other Accessories

Tube Connector

Part No.	Fitting Conf.	Pipe or Hose/ Tube	Fitting Type	Swivel	JIC or 37° Flare	Pressure Rating	Type of Connection	First Connection	Second Connection	Overall Length in (cm)	Material
513308	Straight	Hose/ Tube	Tube Connector	No	No	—	npt(m) x Tube OD	npt - 1/4 npt	Tube OD - .375	—	SST

Swivel Union

Part No.	Fitting Conf.	Pipe or Hose/ Tube	Fitting Type	Swivel	JIC or 37° Flare	Pressure Rating	Type of Connection	First Connection	Second Connection	Overall Length in (cm)	Material
112268	Straight	Pipe	Union	Yes	No	2250 psi (155 bar)	npt(m) x npt(f)	npt - 3/4 npt	npt - 3/4 npt	2.00 (5.1)	304/316 SST
207152	Straight	Pipe	Union	Yes	No	7250 psi (499 bar)	npt(f) x nps(f)	npt - 3/8 npt	nps - 3/8 npsm	1.63 (4.1)	316 SST
236433	Straight	Pipe	Union	No	No	—	npt(m) x nps(f)	npt - 1 npt	nps - 1 npsm	—	303 SST
236892	Straight	Pipe	Union	Yes	No	—	npt(m) x nps(f)	npt - 1/2 npt	nps - 3/8 npsm	—	316 SST
16P309	Straight	Pipe	Union	Yes	No	6000 psi (413 bar)	npt(f) x nps(f)	npt - 1/4 npt	nps - 1/4 npsm	1.43 (3.6)	316 SST

Swivel

Part No.	Fitting Conf.	Pipe or Hose/ Tube	Fitting Type	Swivel	JIC or 37° Flare	Pressure Rating	Type of Connection	First Connection	Second Connection	Overall Length in (cm)	Material
189018	Straight	Pipe	Union	Yes	No	7500 psi (516 bar)	nps(m) x nps(f)	nps - 1/4 npsm	nps - 1/4 npsm	1.41 (3.5)	303/316 SST
236987	Straight	Pipe	Union	Yes	No	7400 psi (509 bar)	nps(m) x nps(f)	nps - 1/4 npsm	nps - 1/4 npsm	—	SST



Hoses, Fittings, Swivels and Gauges

Fluid Gauges

Stainless Steel Low Pressure Fluid Gauges

- Corrosion Resistant
- 2.5 in (63 mm) diameter dial
- 1/4 in NPT(M) connection
- Bottom mount
- Shatterproof glass



Part No.	Pressure Range
187875	0-30 psi (0-2 bar)
187874	0-100 psi (0-7 bar)
187873	0-200 psi (0-14bar)
187876	0-300 psi (0-21 bar)

Stainless Steel High Pressure Fluid Gauges

- Corrosion Resistant
- 2.5 in (63 mm) diameter dial
- 1/4 in NPT(M) connection
- Bottom mount
- Shatterproof glass
- Liquid filled to reduce indicator pulsation



Part No.	Pressure Range
105770	0-1000 psi (0-68 bar)
102814	0-5000 psi (0-344 bar)

Stainless Steel High Pressure Fluid Gauges

- Corrosion Resistant
- 2.5 in (63 mm) diameter dial
- 1/4 in NPT(M) connection
- Back mount
- Shatterproof glass
- Liquid filled to reduce indicator pulsation



Part No.	Pressure Range
113641	0-3000 psi (0-207 bar)
113654	0-5000 psi (0-344 bar)

Stainless Steel Fluid Gauges with Dampeners

- Dampener protects gauge from severe pressure pulsation
- Corrosion Resistant
- 2.5 in (63mm) diameter dial
- 1/4 in NPT connections



Part No.	Pressure Range / Inlet
208855	0-300 psi (0-21 bar) 1/4 in NPT(M)
110182	0-2000 psi (0-140 bar) 1/4 in NPT(F)
206171	0-200 psi (0-140 bar) 1/4 in NPT(F)

Air Gauges

Low Pressure Air Gauges

- Black enamel case
- Bottom mount
- 1/8 in NPT and 1/4 in NPT connections



Part No.	Pressure Range / Inlet
110436	0-100 psi (0-7 bar) 1/8 in NPT(M)
100960	0-200 psi (0-14 bar) 1/4 in NPT(M)

Low Pressure Air Gauges

- Black enamel case
- Back mount
- 1/8 in NPT and 1/4 in NPT connections



Part No.	Pressure Range / Inlet
108190	0-100 psi (0-7 bar) 1/8 in NPT(M)
101689	0-200 psi (0-14 bar) 1/4 in NPT(M)



Other Accessories

Standard Gun Washer

Other Accessories

- Cleans 2 guns and 2 cups
- Plastic tank and reservoir
- Waterborne and non-waterborne compatibility options
- High quality Graco pump for reliability
- Air pressure operating range of 25 to 100 psi (1.7 to 7 bar)
- Maximum tank capacity of 5 gal (18.9 l)
- 112635 has hose wash capability



112635

Ordering Information

Gun Washer Part No.	Description*	Part No.	Quantity	Air Inlet	Fluid Drain Valve	Approx. Dry Weight	Wetted Parts	Manual
112634 (Economy)	Long gun support	512800	1	1/2 npt(f)	1 in npt(m)	63 lb (28.6 kg)	carbon steel, polyethylene (tank), stainless steel, aluminum, brass, PTFE, acetal	308393
	Short gun support	112847	1					
	Spray nozzle	512799	2					
• 112635 (Standard)	Long gun support	512800	2	1/2 npt(f)	1 in npt(m)	65 lb (29.5 kg)	stainless steel, aluminum, polyethylene (tank) brass, PTFE, acetal	308393
	Short gun support	112847	1					
	Spray nozzle	512799	1					

*Long gun support is used to clean pressure feed, air spray and HVLP guns;
Short gun support is used to clean siphon air spray, air-assist and airless guns;
Spray nozzle is used to clean siphon and pressure cups

- Waterborne compatible

Kit Ordering Information

Kit Part No.	Typically Used to Clean	Kit Includes	
		Part No.	Description
236659	Graco Pro AA4500 air-assisted electrostatic guns	195903	Air cap blank
		188406	Tip housing
		183459	Washer (2)
		236689	PRO AA4500 support
		512835	Fluid inlet adapter
		512827	Plug
		512802	Wire trigger lock

Kit Part No.	Typically Used to Clean	Kit Includes	
		Part No.	Description
245271	Graco Pro Xs4 AA electrostatic guns	198786	Air cap blank
		188406	Housing tip
		183459	Washer (2)
		245300	Gun support
		512835	Fluid inlet adapter
		512827	Plug
		512802	Wire trigger lock
		112851	Snap clip



Other Accessories

Professional Gun Washer

Other Accessories

- Corrosion resistant materials
- Cleans 2 guns and 2 cups in one minute
- Cleans hoses and 5 gallon cans
- Pot cleaning kit available
- Flow-through brush/wand for manual cleaning
- Air pressure operating range of 25 to 100 psi (1.7 to 7 bar)
- Maximum tank capacity of 5 gal (18.9 l)
- Fume extractor
- Automatic timer
- FM Approved



117438

Ordering Information

Gun Washer Part No.	Description*	Part No.	Quantity	Air Inlet	Fluid Drain Valve	Approx. Dry Weight	Wetted Parts	Manual
• 117438 (Premium)	Long gun support	512800	2	1/4 npt(f)	1 in npt(m)	86 lb (39 kg)	stainless steel, brass, PTFE, acetal	308393
	Short gun support	112847	1					
	Spray nozzle	512799	1					

*Long gun support is used to clean pressure feed, air spray and HVLP guns;
Short gun support is used to clean siphon air spray, air-assist and airless guns;
Spray nozzle is used to clean siphon and pressure cups

- Waterborne compatible

Kit Ordering Information

Kit Part No.	Typically Used to Clean	Kit Includes	
		Part No.	Description
236659	Graco Pro AA4500 air-assisted electrostatic guns	195903	Air cap blank
		188406	Tip housing
		183459	Washer (2)
		236689	PRO AA4500 support
		512835	Fluid inlet adapter
		512802	Wire trigger lock

Kit Part No.	Typically Used to Clean	Kit Includes	
		Part No.	Description
245271	Graco Pro Xs4 AA electrostatic guns	198786	Air cap blank
		188406	Housing tip
		183459	Washer (2)
		245300	Gun support
		512835	Fluid inlet adapter
		512827	Plug
		512802	Wire trigger lock
112851	Snap clip		



Other Accessories

Fluid Heater Kit

Other Accessories

- Variable heating levels for consistent viscosity control
- Approved for hazardous locations
- 7250 psi (500 bar) maximum working pressure
- Stainless steel construction is compatible with catalyst, waterborne, and other finishing materials
- Includes bracket, hose, and fittings for easy integration



Ordering Information

Part No.	Description
239850	120V fluid heater kit (includes bracket, hose, fittings)
239851	240V fluid heater kit (includes bracket, hose, fittings)
239852	240V fluid heater kit (includes hose, fittings)
241883	200V fluid heater kit (includes bracket, hose, fittings)

Instruction manual [308771](#).

Kits (For President 3:1 Circ Pkgs)

Part No.	Description
Hazardous Location Fluid Heaters, Series A	
245848	120 VAC single phase, 2300 watts, 19.2 amps
245862	200 VAC single phase, 4000 watts, 20 amps
245863	240 VAC single phase, 4000 watts, 16.7 amps
246254	380 VAC single phase, 4000 watts, 10.5 amps
245864	480 VAC single phase, 4000 watts, 8.3 amps
Non-Hazardous Location Fluid Heaters, Series A	
245867	120 VAC single phase, 2300 watts, 19.2 amps
245868	200 VAC single phase, 4000 watts, 20 amps
245869	240 VAC single phase, 4000 watts, 16.7 amps
246276	380 VAC single phase, 4000 watts, 10.5 amps
245870	480 VAC single phase, 4000 watts, 8.3 amps



Other Accessories

Siphon Kits

Other Accessories

Siphon Kits, Tubes, Filters and Intake Extensions

5 gal (19 l) Siphon Kits

Part No.	Description/ Material	Inlet Thread	Hose Tube Material	Hose ID in (mm)	Hose Length ft (m)	Suction Tube Material	Suction Tube Length in (mm)	Use	Manual
206268	CS	3/4 npt(m)	Nylon	3/4 (19)	3.5 (1.0)	Aluminum	18 (457)		
207484	CS	3/4 npsm(f)	Nylon	3/4 (19)	3.5 (1.0)	Aluminum	18 (457)	Pail	
208920	CS	3/4 npsm(f)	Nylon	1.0 (25)	4.0 (1.2)	Aluminum	15 (381)	Pail	
223105	SST	3/4 npt(m)	Nylon	3/4 (19)	6.0 (1.8)	Aluminum	18 (457)		
237068	CS	2.0 npt(m)	Nylon	1.0 (25)	6.0 (1.8)	Aluminum	18 (457)		308415
241634	SST	3/8 JIC	LDPE	0.37 (9.4)	4.0 (1.2)	304 SST	17 (432)		308994
243832	SST	1/2 npsm(f)	LDPE	0.37 (9.4)	3.0 (0.9)	304 SST	17 (432)		309106
244675	CS	3/8 npsm(f)	LDPE	0.37 (9.4)	4.0 (1.0)	Aluminum	17 (432)		
245082	244675 with rock catcher	3/8 npsm(f)	LDPE	0.37 (9.4)	4.0 (1.0)	Aluminum	17 (432)		
245083	241634 with rock catcher	3/8 JIC	LDPE	0.37 (9.4)	4.0 (1.2)	304 SST	17 (432)		
245176	CS	1-1/4 npt(f)	LDPE	1.0 (25)	6 (1.8)	Aluminum	18.25 (464)		
24B337	Merkur cart	3/4 NT	PTFE	0.625 (15.9)	4.0 (1.0)	304 SST	18 (457)		
24B338	Merkur cart	3/4 NT	PTFE	0.875 (22.2)	4.0 (1.0)	304 SST	18 (457)		
24B424	Merkur wall	3/4 NT	PTFE	0.625 (15.9)	4.0 (1.0)	304 SST	18 (457)		
24B425	Merkur wall	3/4 NT	PTFE	0.875 (22.2)	4.0 (1.0)	304 SST	18 (457)		



Other Accessories

Siphon Kits

Other Accessories

Siphon Kits

55 gal (208 l) Siphon Kits

Part No.	Description/ Material	Inlet Thread	Hose Tube Material	Hose ID in (mm)	Hose Length ft (m)	Suction Tube Material	Suction Tube Length in (mm)	Use	Manual
203992	low level shut off/CS	1-1/2 npt(m)	Buna	3/4 (19)	6 (1.8)	CS	36 (914)	Drum	306508
207485	with ball check/CS	3/4 npsm(f)	Nylon	3/4 (19)	6 (1.8)	CS	36 (914)	Drum	
208259	CS	3/4 npsm(f)	Nylon	3/4 (19)	6 (1.8)	CS	36 (914)	Drum	
222916	CS	2 npt(m0)	Polyethylene	1.5 (38)	8 (2.4)	CS	36 (914)	Drum	308081
223009	with screen filter/CS	3/4 npt(m)	Nylon	3/4 (19)	6 (1.8)	CS	36 (914)	Drum	
224834	Husky 307 drum mount kit/Acetal	3/8 npt(m)	NA	NA	NA	Acetal	34.75 (883)		
235502	Husky 307 wall mount	3/8 npt(m)	Polypropylene	3/8 (9.5)	6 (1.8)	Polypropylene	38 (965)		
236951	CS	1 npt(m)	Nylon	3/4 (19)	6 (1.8)	CS	36 (914)		
241321	CS	1 npsm(f)	Nylon	3/4 (19)	6 (1.8)	CS	36 (914)		
245084	244677 with strainer	3/8 npsm(f)	LDPE	.037 (9.4)	6 (1.8)	Aluminum	38 (965)		
245085	244676 with strainer	3/8 JIC(f)	LDPE	.037 (9.4)	6 (1.8)	304 SST	38 (965)		
244676	Triton/SST	3/8 JIC(f)	LDPE	.037 (9.4)	6 (1.8)	304 SST	38 (965)		
244677	Triton/CS	3/8 npsm(f)	LDPE	.037 (9.4)	6 (1.8)	Aluminum	38 (965)		
685599	SST	3/4 npt(f)	Nylon	3/4 (19)	6 (1.8)	304 SST	34 (864)		
24A954	Merkur drum		Nylon	3/4 (19)	5 (1.5)	304 SST	42 (1067)		
24A598	Merkur drum		Nylon	1 (25.4)	5 (1.5)	304 SST	41 (1041)		

Siphon Tubes

Part No.	Outlet Size in	Length in (mm)	OD Size	Use
165767	3/4 npt(f)	18.0 (450)	7/8 in	Pail
206266	3/4 npt(f)	37.0 (940)	1-1/2 in	Drum
170113	3/4 in dia.*	18.0 (450)	.840 in	Pail
166630	1 npt(mbe)	30.0 (762)	1-5/16 in	Drum
246419	1 npt	37.0 (940)	1-1/2 in	Drum

*Non-threaded: 101818 hose clamp required.



Other Accessories

Ground Clamp

Other Accessories

- Properly ground equipment to prevent sparks or other hazards.
- Ground work piece to maximize transfer efficiency with electrostatic guns.
- Spring-loaded clamp with sharp teeth ensure proper connection.
- Up to 16 feet long when fully uncoiled. Easily reach and move your work piece.



238909

Ordering Information

Part No.	Description
238909	Coil extends 16 ft 14 GA wire



ABOUT GRACO

PROVEN QUALITY. LEADING TECHNOLOGY.

Founded in 1926, Graco is a world leader in fluid handling systems and components. Graco products move, measure, control, dispense and apply a wide range of fluids and viscous materials used in vehicle lubrication, commercial and industrial settings.

The company's success is based on its unwavering commitment to technical excellence, world-class manufacturing and unparalleled customer service. Working closely with qualified distributors, Graco offers systems, products and technology that set the quality standard in a wide range of fluid handling solutions. Graco provides equipment for spray finishing, protective coating, paint circulation, lubrication, and dispensing sealants and adhesives, along with power application equipment for the contractor industry. Graco's ongoing investment in fluid management and control will continue to provide innovative solutions to a diverse global market.

GRACO LOCATIONS

MAILING ADDRESS

P.O. Box 1441
Minneapolis, MN 55440-1441
Tel: 612-623-6000
Fax: 612-623-6777

AMERICAS

MINNESOTA

Worldwide Headquarters
Graco Inc.
88-11th Avenue N.E.
Minneapolis, MN 55413

EUROPE

BELGIUM

European Headquarters
Graco N.V.
Industrieterrein-Oude Bunders
Slakweidestraat 31
3630 Maasmechelen,
Belgium
Tel: 32 89 770 700
Fax: 32 89 770 777

ASIA PACIFIC

AUSTRALIA

Graco Australia Pty Ltd.
Suite 17, 2 Enterprise Drive
Bundoora, Victoria 3083
Australia
Tel: 61 3 9468 8500
Fax: 61 3 9468 8599

CHINA

Graco Hong Kong Ltd.
Shanghai Representative Office
Building 7
1029 Zhongshan Road South
Huangpu District
Shanghai 200011
The People's Republic of China
Tel: 86 21 649 50088
Fax: 86 21 649 50077

INDIA

Graco Hong Kong Ltd.
India Liaison Office
Room 443, Augusta Point
Regus Business Centre 53
Golf Course Road
Gurgaon, Haryana
India 122001
Tel: 91 124 435 4208
Fax: 91 124 435 4001

JAPAN

Graco K.K.
1-27-12 Hayabuchi
Tsuzuki-ku
Yokohama City, Japan 2240025
Tel: 81 45 593 7300
Fax: 81 45 593 7301

KOREA

Graco Korea Inc.
Shinhan Bank Building
4th Floor #1599
Gwanyang-Dong, Dongan-Ku,
Anyang-si, Korea 431-060
Tel: 82 31 476 9400
Fax: 82 31 476 9801

SALES/ DISTRIBUTION/ SERVICE

Call today for product information or to request a demonstration.

877-84GRACO (1-877-844-7226) or visit us at www.graco.com.

Graco Inc. is registered to I.S. EN ISO 9001



North America
Customer Service
800-328-0211
Fax 877-340-6427