

Integrated Air Control Modules

311239H

EN

Integrated air controls for use with NXT[®] Model 2200, 3400, and 6500 Air Motors. For professional use only.

100 psi (0.69 MPa, 6.9 bar) Maximum Regulated Working Pressure

NXT011, Series E

With locking air regulator and 110 psi (0.76 MPa, 7.6 bar) relief valve

NXT021, Series E

With non-locking air regulator and 110 psi (0.76 MPa, 7.6 bar) relief valve

NXT031, Series E

With locking air regulator and 85 psi (0.58 MPa, 5.8 bar) relief valve



Important Safety Instructions

Read all warnings and instructions in this manual and in NXT air motor manual 311238. Save these instructions.

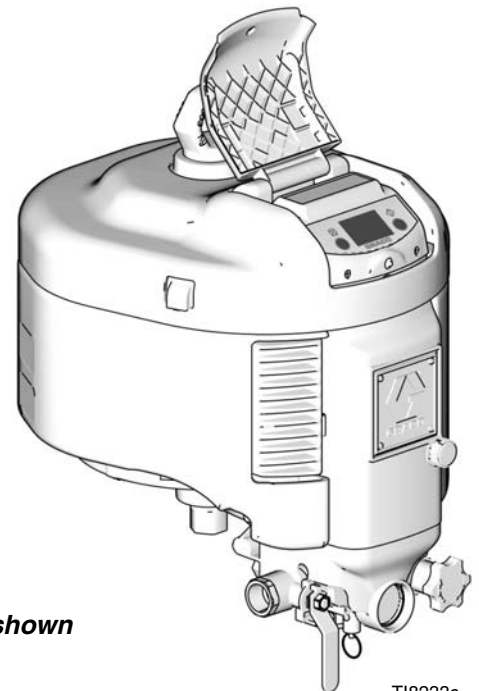

Integrated Air Control Module shown mounted on an NXT Air Motor

T18233c

Contents

Related Manuals	2	Parts	12
Warnings	3	Accessories	13
Installation	4	Schematic Diagram	14
Operation	5	Technical Data	15
Troubleshooting	7	Graco Standard Warranty	16
Repair	9	Graco Information	16

Related Manuals





Manuals are available at www.graco.com.

This manual is available in the following languages:

Manual	Language
3A0081	Chinese
3A0082	Danish
3A0083	French
3A0084	Finnish
3A0085	German
3A0086	Greek
3A0087	Italian
3A0088	Japanese
3A0089	Korean
3A0090	Norwegian
3A0091	Polish
3A0092	Portuguese
312917	Russian
313800	Spanish
3A0093	Swedish
3A0094	Turkish

Warnings

The following warnings are for the setup, use, grounding, maintenance, and repair of this equipment. The exclamation point symbol alerts you to a general warning and the hazard symbols refer to procedure-specific risks. Refer back to these Warnings. Additional, product-specific warnings may be found throughout the body of this manual where applicable.

 WARNING	
	<p>PRESSURIZED EQUIPMENT HAZARD</p> <p>Fluid from the gun/dispense valve, leaks, or ruptured components can splash in the eyes or on skin and cause serious injury.</p> <ul style="list-style-type: none"> • Follow Pressure Relief Procedure in this manual, when you stop spraying and before cleaning, checking, or servicing equipment. • Tighten all fluid connections before operating the equipment. • Check hoses, tubes, and couplings daily. Replace worn or damaged parts immediately.
	<p>PERSONAL PROTECTIVE EQUIPMENT</p> <p>You must wear appropriate protective equipment when operating, servicing, or when in the operating area of the equipment to help protect you from serious injury, including eye injury, inhalation of toxic fumes, burns, and hearing loss. This equipment includes but is not limited to:</p> <ul style="list-style-type: none"> • Protective eyewear • Clothing and respirator as recommended by the fluid and solvent manufacturer • Gloves • Hearing protection
	<p>EQUIPMENT MISUSE HAZARD</p> <p>Misuse can cause death or serious injury.</p> <ul style="list-style-type: none"> • Do not operate the unit when fatigued or under the influence of drugs or alcohol. • Do not exceed the maximum working pressure or temperature rating of the lowest rated system component. See Technical Data in all equipment manuals. • Use fluids and solvents that are compatible with equipment wetted parts. See Technical Data in all equipment manuals. Read fluid and solvent manufacturer's warnings. For complete information about your material, request MSDS forms from distributor or retailer. • Check equipment daily. Repair or replace worn or damaged parts immediately with genuine Graco replacement parts only. • Do not alter or modify equipment. • Use equipment only for its intended purpose. Call your Graco distributor for information. • Route hoses and cables away from traffic areas, sharp edges, moving parts, and hot surfaces. • Do not kink or over bend hoses or use hoses to pull equipment. • Keep children and animals away from work area. • Comply with all applicable safety regulations.

Installation

 Air Control Modules NXT011 and NXT031 (locking air regulator) and NXT021 (non-locking air regulator) are available.

1. Install supplied o-ring (43) into counterbore on upper side of air control module (D). Fasten module to air motor (M) with two supplied screws (44). Start threading screws by hand before using a tool. Torque to 20 ft-lb (27.1 N•m).

 Screws are thread-forming. Start threading by hand before using a tool. Torque to 20 ft-lb (27.1 N•m).

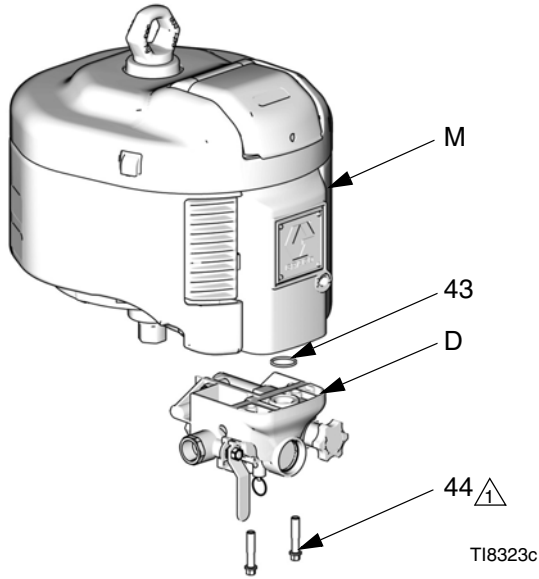

2. Close bleed-type master air valve (B).

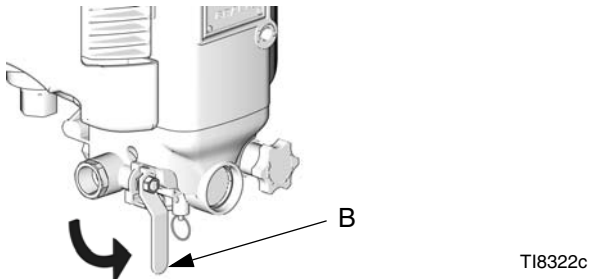

3. Turn air regulator knob (C) fully counterclockwise.

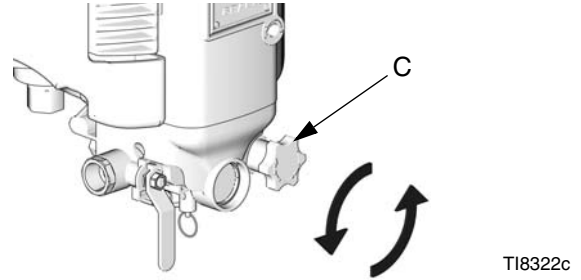

4. Hold the 3/4 npt(f) air inlet fitting (A) with a 1-5/16 in. wrench to prevent it from turning while securely connecting the air supply hose.

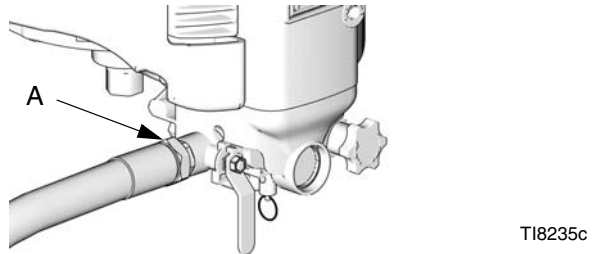

Operation



Component Identification

 Air Control Modules NXT011 and NXT031 (locking air regulator) and NXT021 (non-locking air regulator) include air line components in an integrated assembly. See FIG. 1.

Key for FIG. 1

- A Air Inlet, 3/4 npt(f)
- B Bleed-type Master Air Valve
- C Air Regulator Adjustment Knob (locking or non-locking)
- D Air Pressure Gauge
- E Air Filter (partially hidden)
- F Safety Relief Valve

Bleed-type Master Air Valve (B)

						
Trapped air can cause the pump to cycle unexpectedly, which could result in serious injury from splashing or moving parts.						

The bleed-type master air valve is required in your system to relieve air trapped between it and the air motor when the valve is closed.

Air Regulator (C)

Adjusts air pressure to the motor and fluid outlet pressure of pump. View the gauge (D) to read air pressure.

Air Filter (E)

Removes harmful contaminants from entering the air control module and air motor.

Safety Relief Valve (F)

Automatically opens to relieve air pressure, to prevent pump overpressurization.

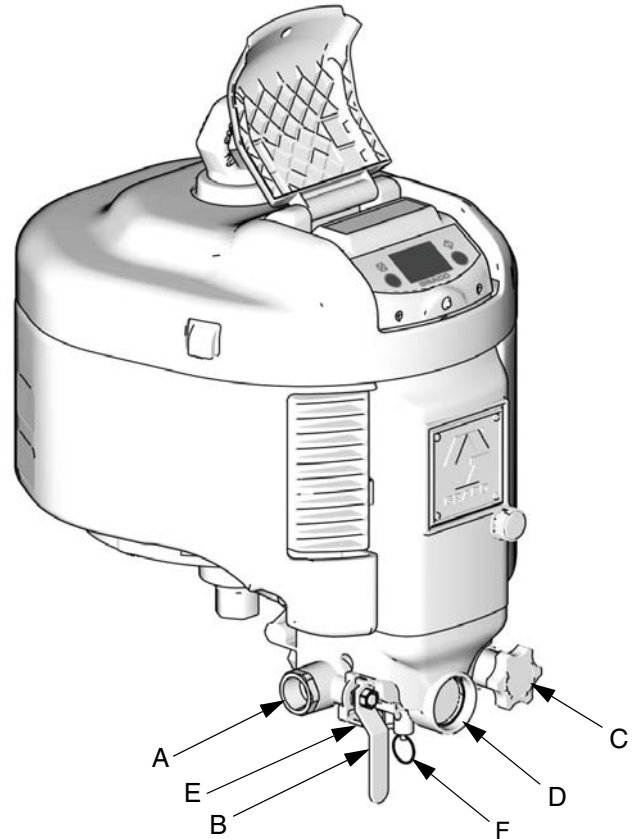

TI8233c

FIG. 1: Air Control Module Mounted on NXT Air Motor

Startup

1. Turn air regulator knob (C) fully counterclockwise.

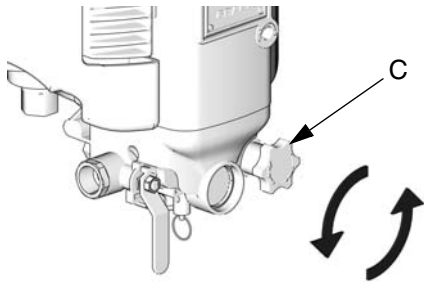

TI8322c

 A small amount of air venting through knob assembly (18) is normal.

2. Open bleed-type master air valve (B).

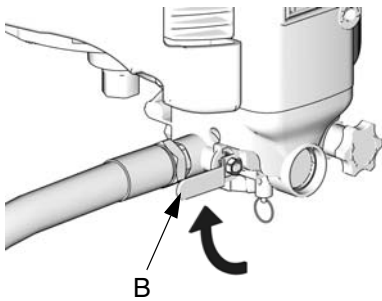

TI8236c

3. Turn air regulator knob (C) clockwise until air pressure reaches desired setpoint.

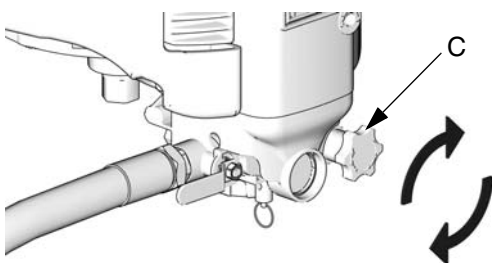

TI8236c

Locking Regulator (NXT011 and NXT031 only)

1. To lock pressure setpoint, push knob (C) in.

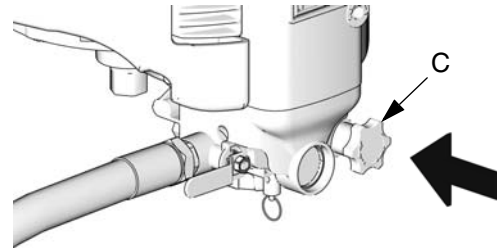

TI8236c

2. Pull knob out to unlock, then adjust regulator to desired pressure setpoint.

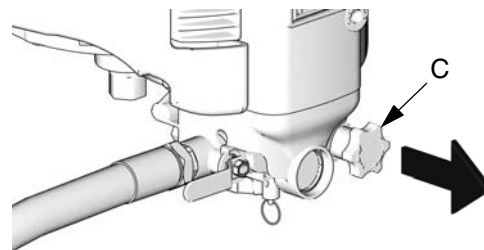

TI8236c



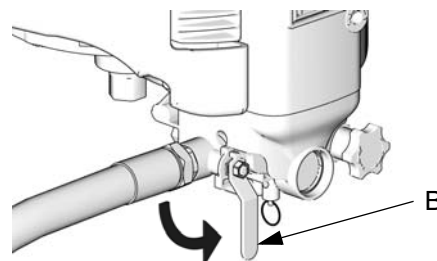

Shutdown

Close bleed-type master air valve (B).



TI8235c



Troubleshooting

Problem	Cause	Solution
Excess air leaking from regulator housing, or gauge shows unstable regulated pressure.	Loose or worn diaphragm (17d).	Tighten housing or repair regulator using repair kit NXT095. See page 10.
	Worn seat (17e) or poppet (17f).	Repair regulator using repair kit NXT095. See page 10.
	Main spool seals or relief valve worn.	Replace with spool kit NXT098, page 10.
	Quick exhaust poppet (20b) or seat (20a) worn.	Replace with quick exhaust repair kit NXT099, page 10.
Air leaking from quick exhaust vent hole.	Worn poppet o-ring (20c).	Replace with quick exhaust repair kit NXT099, page 10.
	Quick exhaust poppet (20b) or seat (20a) worn.	Replace with quick exhaust repair kit NXT099, page 10.
Air leaking from ball valve vent hole.	Loose inlet fitting (32a).	Tighten inlet fitting. See page 11.
	Worn valve seals (32b, 32d).	Repair ball valve using repair kit NXT097. See page 11.
Regulator does not regulate pressure.	Worn spool o-rings or worn/damaged diaphragm (17d).	   
		<p>With air on and bleed-type master air valve (B) open, unscrew the regulator housing (19).</p> <ul style="list-style-type: none"> If pressure drops, diaphragm is damaged. Install Repair Kit NXT095, page 10. If air leaks out bottom orifice, spool o-rings are worn. Install Repair Kit NXT098, page 10.
Gauge will not go to 0 when ball valve is open and knob is turned counter-clockwise to 0.	Washer (17c) is on wrong side of diaphragm (17d).	Move washer (17c) to spring side of diaphragm.
	Pilot air seat (17e) is not fully seated.	Turn pilot air seat (17e) in until it fully seats.
	Seal (3) is too thin or damaged causing air to leak into pilot air chamber.	Replace snail seal (3). Seal should have a minimum thickness of 0.065 in. (1.65 mm).

Problem	Cause	Solution
Gauge pressure increases above set point pressure.	Leak across rear spool (8) o-ring, which raises pilot air pressure even while spraying.	Replace spool assembly (8) with spool kit NXT098.
	Leak across front spool (8) o-ring, which raises air motor pressure when stalled.	Replace spool assembly (8) with spool kit NXT098.
	Spool assembly (8) sticking.	Clean and lubricate spool (8). Add oil to filter cup and run motor. Or, add a lubricator to air supply.
	Seal (3) leaking.	Replace snail seal (3). Seal should have a minimum thickness of 0.065 in. (1.65 mm).
	Side hole or through vent plugged on diaphragm tube (17d).	Clean through vent and side 0.015 in. (0.381 mm) hole.
Air pressure drops when pump is cycling.	Air hose has too small of an inside diameter.	Use a 3/4 in. ID air hose.
	Air supply is not adequate. (Check gauge between hose and inlet.)	Use a larger air compressor.
	Air filter (6) is plugged.	Replace air filter with kit NXT092. Or, upgrade to a larger coalescing filter with a manual drain (NXT094), or with an automatic drain (NXT093). See Accessories (page 13) and manual 406659.

Repair

Pressure Relief Procedure

						
<p>Follow Pressure Relief Procedure when you stop spraying and before cleaning, checking, or servicing equipment.</p>						

1. Close bleed-type master air valve (B).

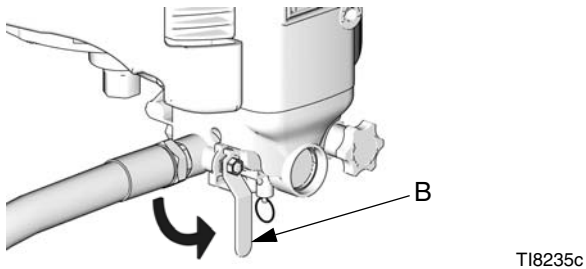

2. Make sure gauge (D) reads zero (0). If not, pull on pressure relief ring to bleed off air pressure.

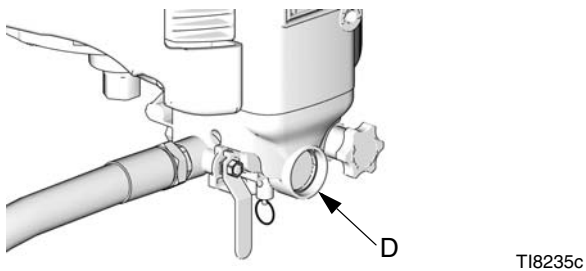

3. Turn air regulator knob (C) fully counterclockwise.

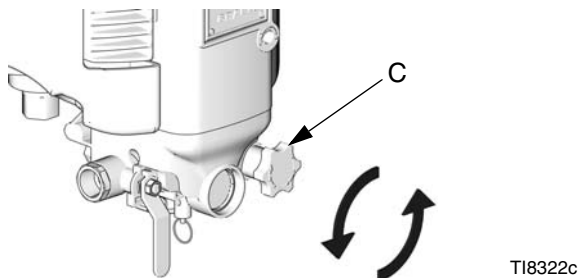

Replace Filter Element

1. Relieve pressure, page 9.
2. Remove filter bowl (E) with wrench. Remove filter element (G).
3. Install new filter element (G) on boss within the bowl (E). Reinstall bowl 1/4 turn past handtight.

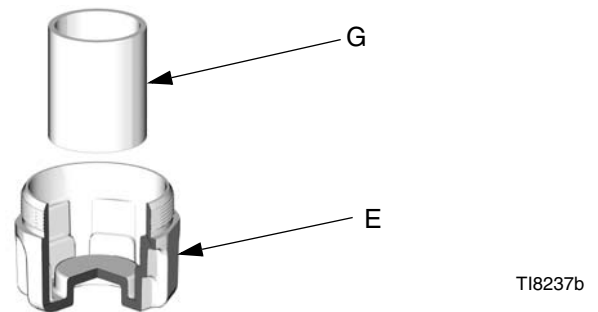

Replace Gauge

1. Relieve pressure, page 9.
2. See **Parts** drawing, page 12. Using a 7/16 open-end wrench on the flats, unscrew old gauge (31).
3. Apply PTFE tape to threads before installing new gauge.

Spool Repair Kit NXT098

1. Relieve pressure, page 9.
2. See **Parts** drawing, page 12. Using a 1/4 in. drive ratchet or a 3/8 in. deep well socket, remove 2 screws (37). Use a 3/8 in. open-end wrench to remove the third screw (37) and disassemble front cover (5) from housings (1, 2). Remove spring (16).
3. Pull the spool assembly (8) out of the housing (1). Use a pliers to carefully pull the spool assembly out by the tip.
4. Clean and lubricate the bore in the housing (1).
5. Install the new spool (8), spring (16), and o-ring (38).

Regulator Repair Kit NXT095

1. Relieve pressure, page 9.
2. See **Parts** drawing, page 12. Using a 1-3/8 in. open-end wrench, unscrew the regulator housing (19).
3. Remove adjustment screw (17a), spring (17b), slip ring (17c), diaphragm (17d), and washer (48).
4. Using #2 Phillips screwdriver, remove valve seat (17e) slowly to avoid damaging flutes. Remove valve assembly (17f) and spring (17g).
5. Use all new parts in the kit. Reinstall the spring (17g), valve assembly (17f), washer (48), and valve seat (17e). Tighten seat slowly to avoid damaging flutes.
6. Do not apply any lubricant on the seating area of the diaphragm (17d). Reinstall diaphragm, slip ring (17c), spring (17b), and adjustment screw (17a).

Quick Exhaust Repair Kit NXT099

1. Relieve pressure, page 9.
2. See **Parts** drawing, page 12. Using a 3/8 in. deep well socket, remove 2 screws (37). Use a 3/8 in. open-end wrench to remove the third screw (37) and disassemble front cover (5) from housings (1, 2). Remove spring (16).
3. Remove seat (20a) with large flat blade screwdriver. Work out the poppet (20b) from the hole beneath the poppet using an o-ring pick or an allen wrench.
4. Liberally grease housing threads to avoid damaging o-ring (20c) on new poppet (20b). Install new poppet with o-ring. Install new seat (20a) until it bottoms out tight in the housing.

Ball Valve Seal Repair Kit NXT097

1. Relieve pressure, page 9.
2. See **Parts** drawing, page 12. Remove the inlet fitting (32a) using a 1 5/16 in. wrench.
3. See FIG. 2. Move the handle to the 7:30 position. Remove the outboard seal (32b) with an o-ring pick.
4. See FIG. 2. Move the handle to the 6:00 position. Remove the ball (32c) using adhesive tape. Remove the inboard seal (32d) with an o-ring pick.

 Use notes on page 12 as a guide while completing step 5.

5. Install the new inboard seal (32d). Install the new ball (32c) with the notch (N) facing the front of the module, so it engages the valve stem (33). The flat spot on the ball must face inward.

6. Install the new outboard seal (32b) and inlet fitting (32a). Torque to 500 in-lb (56 N•m).

 The stem seal components (32e-32k) do not need replacement unless leakage is noted. If necessary, replace parts as shown on page 12.

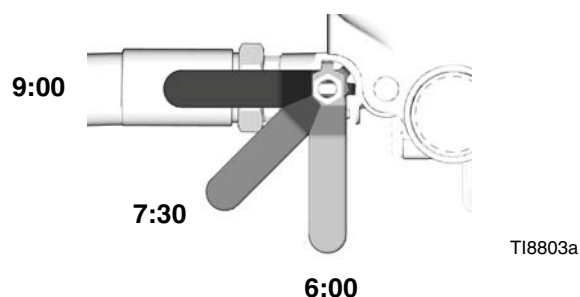
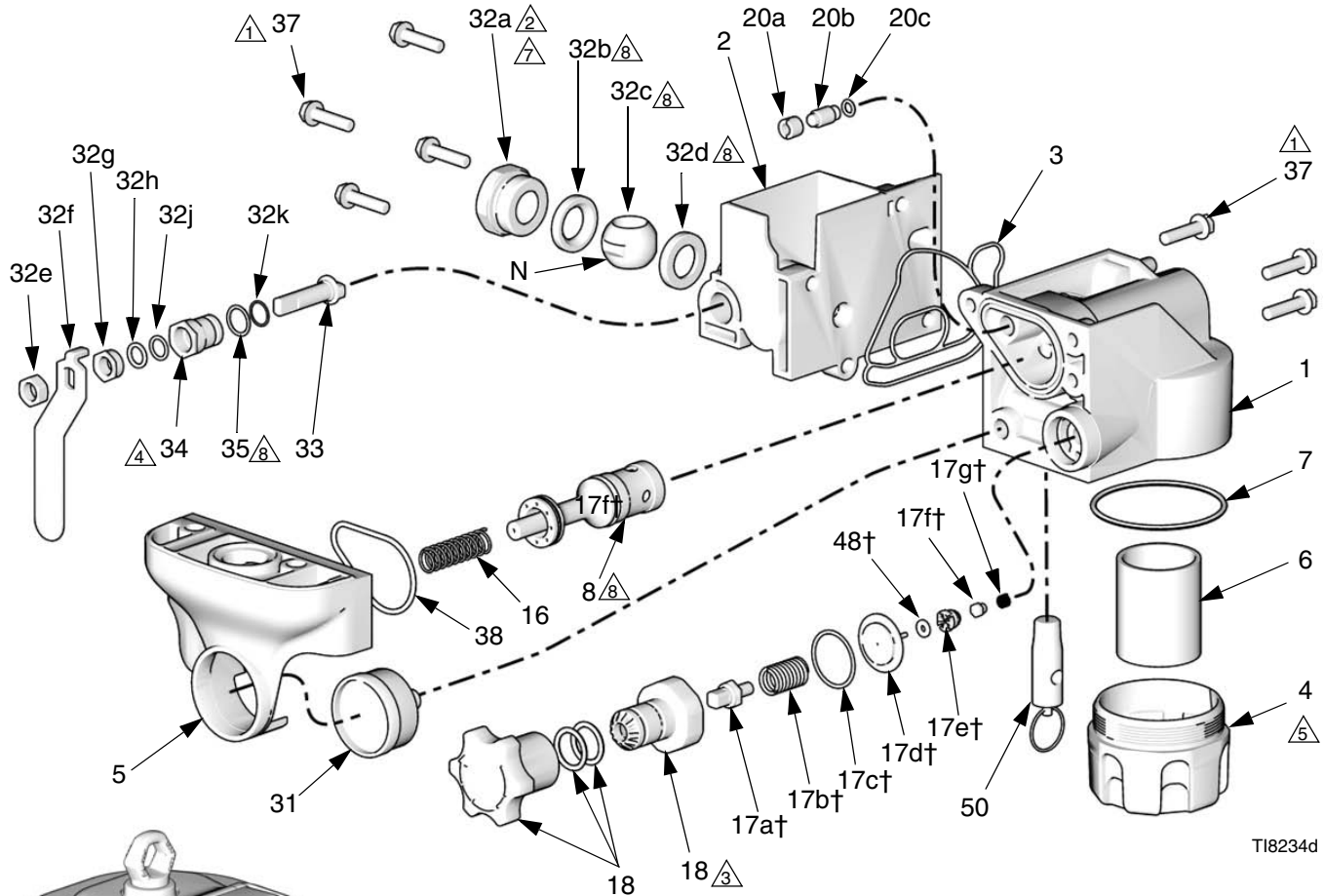

FIG. 2. Valve Handle Positions

Parts

NXT011 and NXT031 Locking Integrated Air Control Module

NXT021 Non-Locking Integrated Air Control Module



T18234d

- △1 Torque to 140 in-lb (16 N•m).
- △2 Torque to 500 in-lb (56 N•m).
- △3 Torque to 240 in-lb (27 N•m).
- △4 Torque to 130 in-lb (15 N•m).
- △5 Install bowl 1/4 turn past handtight.
- △6 Screws are thread-forming. Start threading by hand before using a tool. Torque to 20 ft-lb (27.1 N•m).
- △7 Apply blue thread lock sealant.
- △8 Apply lithium grease.

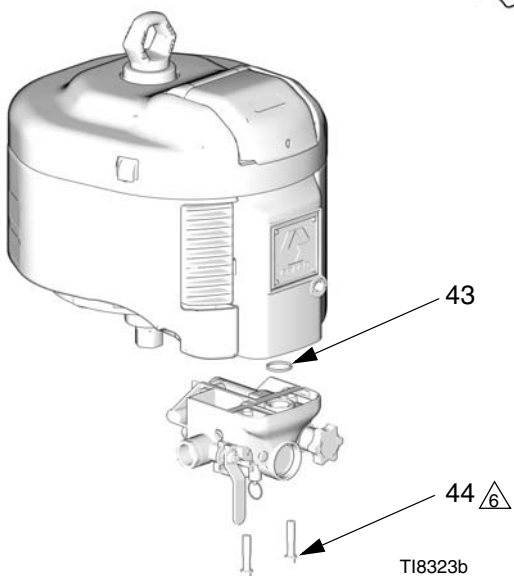

T18323b

Ref. No.	Part No.	Description	Qty
1	15G298	HOUSING, right	1
2	15G299	HOUSING, left	1
3*	15G439	GASKET; nitrile	1
4	277109	BOWL, filter	1
5	277107	COVER, front	1
6✓	NXT092	ELEMENT, filter, 40 micron; package of 10	1
7*	103209	O-RING; fluoroelastomer	1
8	NXT098	SPOOL, valve	1
16	119987	SPRING, compression	1
17†	NXT095	KIT, repair, regulator; includes items 17a-17g	1
18	NXT090	KNOB ASSEMBLY, regulator, locking; NXT011 and NXT031	1
	NXT091	KNOB ASSEMBLY, regulator, non-locking; NXT021	1
20	NXT099	KIT, relief valve; includes items 20a-20c	1
31✓	108190	GAUGE, pressure, air	1
32	NXT097	KIT, repair, ball valve; 3/4 npt(f) inlet; includes items 32a-32k	1
33	15F726	STEM, ball valve	1
34	15F727	INSERT, threaded, ball valve	1
35*	C20145	O-RING; buna-N	1
37	119426	SCREW, machine, hex washer hd, thread-forming; 1/4-20 x 1 in. (25 mm)	7
38*	115078	O-RING; nitrile	1
43	110782	O-RING; buna-N	1
44	120089	SCREW; 3/8-16 x 1-3/4 in. (44 mm)	2
48†	187509	WASHER, flat	1
50	113498	RELIEF VALVE, safety; 110 psi (0.76 MPa, 7.6 bar); NXT011 and NXT021	1
	108124	RELIEF VALVE, safety; 75 psi (0.51 MPa, 5.1 bar); NXT031	1

* Parts included in Seal Repair Kit NXT096 (purchase separately).

✓ Recommended spare parts. Keep on hand to avoid downtime.

† Parts included in Air Regulator Repair Kit NXT095 (purchase separately.)

Accessories

Kit	Description
NXT090	Locking knob kit
NXT091	Non-locking knob kit
NXT092	Filter element, 40 micron, package of 10
NXT093	Coalescing filter with automatic drain
NXT094	Coalescing filter with manual drain
NXT095	Regulator repair kit
NXT096	Seal repair kit
NXT097	Ball valve repair kit
NXT098	Spool valve kit
NXT099	Relief valve kit
116635	Element replacement kit. For use with kits NXT093 and NXT094.

Schematic Diagram

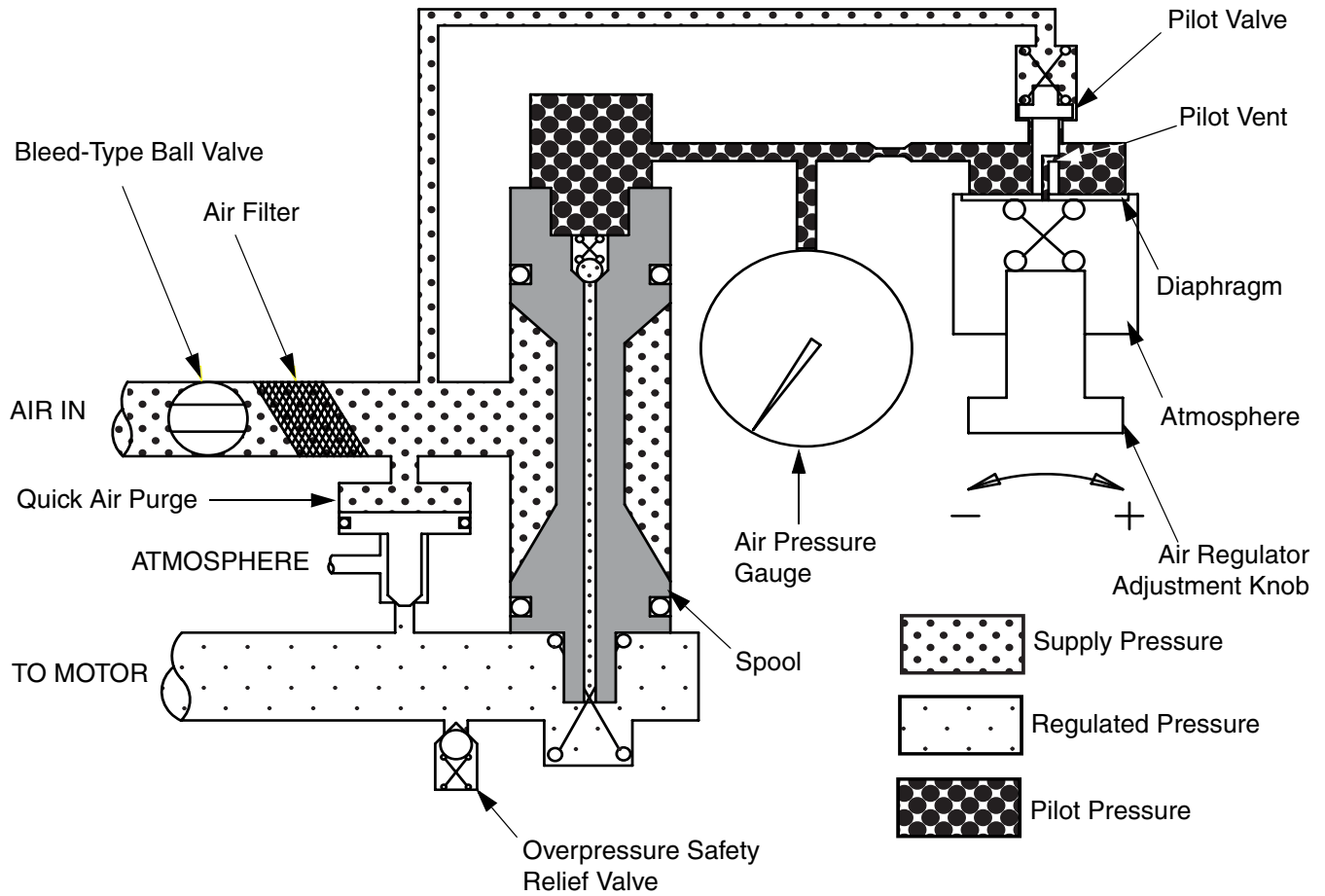

Technical Data

Maximum air inlet pressure	140 psi (0.97 MPa, 9.7 bar)
Maximum regulated working pressure	100 psi (0.69 MPa, 6.9 bar)
Maximum operating temperature	140°F (60°C)
Air Inlet Size	3/4 npt(f)
Air Gauge Port Size	1/8 npt(m)
Height	6.5 in. (165 mm)
Width	6.75 in. (171 mm)
Depth	4.75 in. (121 mm)
Weight	5.1 lb (2.3 kg)
Materials of construction	Chrome, brass, aluminum, acetal, fluorocarbon rubber, nylon, nitrile rubber, fluoroelastomer

Graco Standard Warranty

Graco warrants all equipment referenced in this document which is manufactured by Graco and bearing its name to be free from defects in material and workmanship on the date of sale to the original purchaser for use. With the exception of any special, extended, or limited warranty published by Graco, Graco will, for a period of twelve months from the date of sale, repair or replace any part of the equipment determined by Graco to be defective. This warranty applies only when the equipment is installed, operated and maintained in accordance with Graco's written recommendations.

This warranty does not cover, and Graco shall not be liable for general wear and tear, or any malfunction, damage or wear caused by faulty installation, misapplication, abrasion, corrosion, inadequate or improper maintenance, negligence, accident, tampering, or substitution of non-Graco component parts. Nor shall Graco be liable for malfunction, damage or wear caused by the incompatibility of Graco equipment with structures, accessories, equipment or materials not supplied by Graco, or the improper design, manufacture, installation, operation or maintenance of structures, accessories, equipment or materials not supplied by Graco.

This warranty is conditioned upon the prepaid return of the equipment claimed to be defective to an authorized Graco distributor for verification of the claimed defect. If the claimed defect is verified, Graco will repair or replace free of charge any defective parts. The equipment will be returned to the original purchaser transportation prepaid. If inspection of the equipment does not disclose any defect in material or workmanship, repairs will be made at a reasonable charge, which charges may include the costs of parts, labor, and transportation.

THIS WARRANTY IS EXCLUSIVE, AND IS IN LIEU OF ANY OTHER WARRANTIES, EXPRESS OR IMPLIED, INCLUDING BUT NOT LIMITED TO WARRANTY OF MERCHANTABILITY OR WARRANTY OF FITNESS FOR A PARTICULAR PURPOSE.

Graco's sole obligation and buyer's sole remedy for any breach of warranty shall be as set forth above. The buyer agrees that no other remedy (including, but not limited to, incidental or consequential damages for lost profits, lost sales, injury to person or property, or any other incidental or consequential loss) shall be available. Any action for breach of warranty must be brought within two (2) years of the date of sale.

GRACO MAKES NO WARRANTY, AND DISCLAIMS ALL IMPLIED WARRANTIES OF MERCHANTABILITY AND FITNESS FOR A PARTICULAR PURPOSE, IN CONNECTION WITH ACCESSORIES, EQUIPMENT, MATERIALS OR COMPONENTS SOLD BUT NOT MANUFACTURED BY GRACO. These items sold, but not manufactured by Graco (such as electric motors, switches, hose, etc.), are subject to the warranty, if any, of their manufacturer. Graco will provide purchaser with reasonable assistance in making any claim for breach of these warranties.

In no event will Graco be liable for indirect, incidental, special or consequential damages resulting from Graco supplying equipment hereunder, or the furnishing, performance, or use of any products or other goods sold hereto, whether due to a breach of contract, breach of warranty, the negligence of Graco, or otherwise.

FOR GRACO CANADA CUSTOMERS

The Parties acknowledge that they have required that the present document, as well as all documents, notices and legal proceedings entered into, given or instituted pursuant hereto or relating directly or indirectly hereto, be drawn up in English. Les parties reconnaissent avoir convenu que la rédaction du présente document sera en Anglais, ainsi que tous documents, avis et procédures judiciaires exécutés, donnés ou intentés, à la suite de ou en rapport, directement ou indirectement, avec les procédures concernées.

Graco Information

For the latest information about Graco products, visit www.graco.com.

TO PLACE AN ORDER, contact your Graco distributor or call to identify the nearest distributor.

Phone: 612-623-6921 **or Toll Free:** 1-800-328-0211 **Fax:** 612-378-3505

*All written and visual data contained in this document reflects the latest product information available at the time of publication.
Graco reserves the right to make changes at any time without notice.*

Original instructions. This manual contains English. MM 311239

Graco Headquarters: Minneapolis

International Offices: Belgium, China, Japan, Korea

GRACO INC. AND SUBSIDIARIES • P.O. BOX 1441 • MINNEAPOLIS MN 55440-1441 • USA

Copyright 2006, Graco Inc. All Graco manufacturing locations are registered to ISO 9001.

www.graco.com
Revised 07/2011