

AirPro™ Gravity Feed Airspray Gun

312579K
EN

***Conventional, HVLP, and compliant guns for specialty industrial applications.
For professional use only.***

100 psi (0.7 MPa, 7 bar) Maximum Air Inlet Pressure



Important Safety Instructions

Read all warnings and instructions in this manual. Save these instructions.

See page 3 for model information.

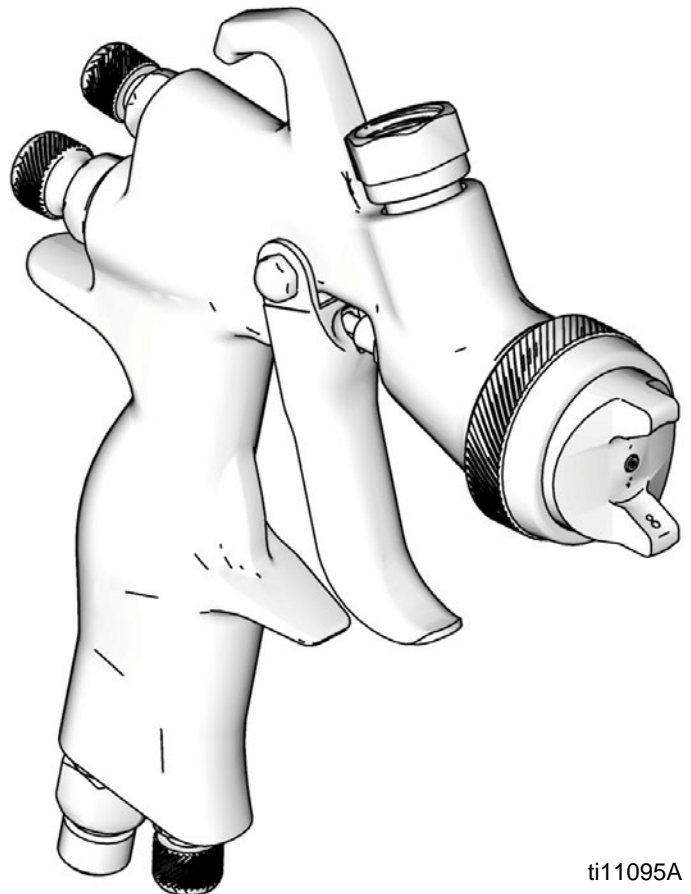

ti11095A



Contents

Models	3
Gravity Feed without Cup	3
Gravity Feed with Plastic Cup	3
Gravity Feed with 3M™ PPS™ Cup	3
Warnings	4
Gun Selection	5
Conventional Guns	5
HVLP Guns	5
Compliant Guns	5
Setup	6
Ground the Gun	6
Flush Before Using Equipment	6
Adjust Spray Pattern	7
Operation	8
Pressure Relief Procedure	8
Apply Fluid	8
Volatile Organic Compounds (VOC) Regulation ..	8
Daily Gun Maintenance	9
General Tasks	9
Flush	9
Clean Gun and Cup	9
Clean Nozzle and Air Cap	10
Compliant Cleaning Methods	10
Troubleshooting	12
Repair	14
Disassembly	14
Fluid Inlet Fitting Replacement	14
Reassembly	15
Parts	16
Accessories	18
Repair Kits	19
Technical Data	20
Graco Standard Warranty	22
Graco Information	22

Models

Gravity Feed without Cup

Orifice Size in. (mm)	Conventional			HVLP			Compliant		
	Model	Series	Max. HVLP/Compliant Air Pressure psi (MPa, bar)	Model	Series	Max. HVLP/Compliant Air Pressure psi (MPa, bar)	Model	Series	Max. HVLP/Compliant Air Pressure psi (MPa, bar)
0.055 (1.4)	289002	A	N/A	289005	A	29 (0.2, 2.0)	289008	A	35 (0.24, 2.4)
0.070 (1.8)	289003	A	N/A	289006	A	29 (0.2, 2.0)	289009	A	35 (0.24, 2.4)

Gravity Feed with Plastic Cup





Orifice Size in. (mm)	Conventional			HVLP			Compliant		
	Model	Series	Max. HVLP/Compliant Air Pressure psi (MPa, bar)	Model	Series	Max. HVLP/Compliant Air Pressure psi (MPa, bar)	Model	Series	Max. HVLP/Compliant Air Pressure psi (MPa, bar)
0.055 (1.4)	289011	A	N/A	289014	A	29 (0.2, 2.0)	289017	A	35 (0.24, 2.4)
0.070 (1.8)	289012	A	N/A	289015	A	29 (0.2, 2.0)	289018	A	35 (0.24, 2.4)

Gravity Feed with 3M™ PPS™ Cup

Orifice Size in. (mm)	Conventional			HVLP			Compliant		
	Model	Series	Max. HVLP/Compliant Air Pressure psi (MPa, bar)	Model	Series	Max. HVLP/Compliant Air Pressure psi (MPa, bar)	Model	Series	Max. HVLP/Compliant Air Pressure psi (MPa, bar)
0.055 (1.4)	289020	A	N/A	289023	A	29 (0.2, 2.0)	289026	A	35 (0.24, 2.4)
0.070 (1.8)	289021	A	N/A	289024	A	29 (0.2, 2.0)	289027	A	35 (0.24, 2.4)

Warnings

The following warnings are for the setup, use, grounding, maintenance, and repair of this equipment. The exclamation point symbol alerts you to a general warning and the hazard symbols refer to procedure-specific risks. Refer back to these warnings. Additional, product-specific warnings may be found throughout the body of this manual where applicable.

 WARNING	
	<p>FIRE AND EXPLOSION HAZARD</p> <p>Flammable fumes, such as solvent and paint fumes, in work area can ignite or explode. To help prevent fire and explosion:</p> <ul style="list-style-type: none"> • Use equipment only in well ventilated area. • Eliminate all ignition sources; such as pilot lights, cigarettes, portable electric lamps, and plastic drop cloths (potential static arc). • Keep work area free of debris, including solvent, rags and gasoline. • Do not plug or unplug power cords or turn lights on or off when flammable fumes are present. • Ground all equipment in the work area. See Grounding instructions. • If there is static sparking or you feel a shock, stop operation immediately. Do not use equipment until you identify and correct the problem. • Keep a working fire extinguisher in the work area.
	<p>PRESSURIZED EQUIPMENT HAZARD</p> <p>Fluid from the gun/dispense valve, leaks, or ruptured components can splash in the eyes or on skin and cause serious injury.</p> <ul style="list-style-type: none"> • Follow Pressure Relief Procedure in this manual, when you stop spraying and before cleaning, checking, or servicing equipment. • Tighten all fluid connections before operating the equipment. • Check hoses, tubes, and couplings daily. Replace worn or damaged parts immediately.
	<p>EQUIPMENT MISUSE HAZARD</p> <p>Misuse can cause death or serious injury.</p> <ul style="list-style-type: none"> • Do not exceed the maximum working pressure or temperature rating of the lowest rated system component. See Technical Data in all equipment manuals. • Use fluids and solvents that are compatible with equipment wetted parts. See Technical Data in all equipment manuals. Read fluid and solvent manufacturer's warnings. • Check equipment daily. Repair or replace worn or damaged parts immediately. • Do not alter or modify equipment. • Use equipment only for its intended purpose. Call your Graco distributor for information. • Route hoses and cables away from traffic areas, sharp edges, moving parts, and hot surfaces. • Do not kink or overbend hoses or use hoses to pull equipment. • Keep children and animals away from work area. • Comply with all applicable safety regulations.

 **WARNING****PERSONAL PROTECTIVE EQUIPMENT**

You must wear appropriate protective equipment when operating, servicing, or when in the operating area of the equipment to help protect you from serious injury, including eye injury, inhalation of toxic fumes, burns, and hearing loss. This equipment includes but is not limited to:

- Protective eyewear
- Clothing and respirator as recommended by the fluid and solvent manufacturer
- Gloves
- Hearing protection

Gun Selection

Conventional Guns

Excellent atomization and high production rates typically with some reduction in transfer efficiency.

HVLP Guns

An HVLP gun is a high transfer efficiency gun which limits the air pressure at the air cap to 10 psi (0.07 MPa, 0.7 bar) maximum. In some areas, an HVLP gun is required for compliance with environmental standards.

Compliant Guns

A compliant gun is a high transfer efficiency gun which has been tested to have a transfer efficiency greater than or equal to HVLP guns. The Graco compliant guns have no restrictions on air cap pressures, but the gun inlet pressure must remain under 35 psi (0.24 MPa, 2.4 bar) to remain in compliance.

Setup



- Check that your shop air provides adequate air flow. See **Technical Data**, page 20, for minimum cfm requirements.
 - Recommended 5/16 in. (7.9 mm) ID hose, optional 3/8 in. (10 mm) ID air hose.
 - Set shop air pressure regulator (not supplied) according to paint manufacturer's recommendation. See maximum compliant air pressure on air cap.
 - Make sure no air restrictions, such as low-volume cheater-valves, obstruct the air flow. If an air adjusting valve is desired, use a Graco adjustable air valve (234784).
1. Shut off the air supply.
 2. Install a shutoff valve (not supplied) downstream of the air regulator to shut off gun air.
 3. Install an inline air filter (not supplied) to clean and dry the gun air supply.
 4. Connect a clean, dry, filtered air supply to the air inlet fitting. See FIG. 1.

5. Connect the fluid supply to the fluid inlet fitting.

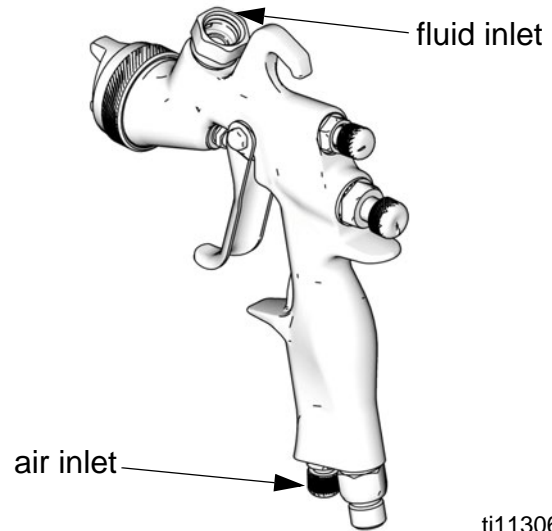

ti11306A

FIG. 1

Ground the Gun

Check your local electrical code for detailed grounding instructions.

Ground the gun through connection to a Graco-approved conductive air supply hose.

Flush Before Using Equipment

The equipment was tested with lightweight oil, which is left in the fluid passages to protect parts. To avoid contaminating your fluid with oil, flush the equipment with a compatible solvent before using the equipment. See **Flush**, page 9.

Adjust Spray Pattern

1. Rotate the air cap to achieve desired spray pattern. See FIG. 2.

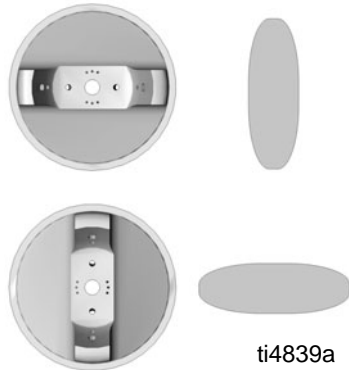

FIG. 2

2. To achieve full fan pattern, open the air control valve by turning the knob fully counterclockwise. See FIG. 3.
3. To create a round pattern, turn the pattern air off by turning the air control valve fully clockwise. See FIG. 3.
4. Trigger gun and adjust gun air pressure. Refer to **Technical Data**, page 20, for inlet air pressure.
5. To establish the correct fluid flow, turn the fluid control valve counterclockwise until no restriction of the trigger movement is felt, then turn out another half turn.

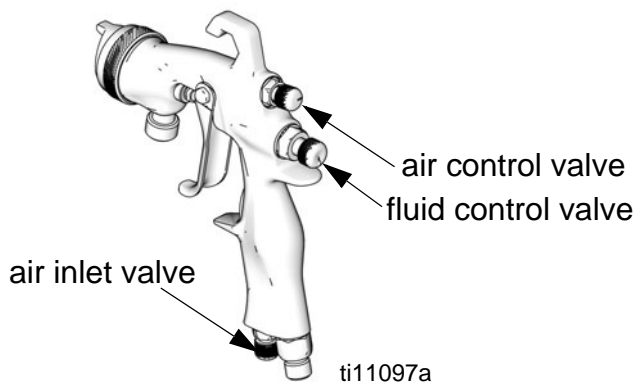
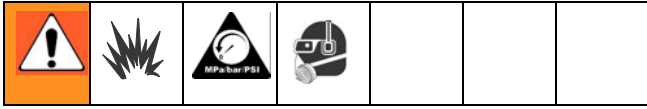

FIG. 3

6. To reduce fluid flow, turn the fluid control valve clockwise.
 - If the fluid control valve is turned clockwise all the way, the gun will emit only air.
 - If you cannot achieve the correct fluid flow with the fluid control valve, a different sized nozzle may be necessary. For smaller fluid flow, use the next size smaller nozzle. For a larger fluid flow, use the next size larger nozzle.
7. Spray a test pattern. Evaluate the spray pattern size and atomization.
8. To achieve a narrow spray pattern, turn air control valve clockwise.
9. To improve atomization, reduce the fluid flow rate. Increasing the air pressure can improve atomization but may result in poor Transfer Efficiency (TE) or non-compliant operation.

Operation



Pressure Relief Procedure

1. Turn off the gun air supply.
2. Trigger the gun to relieve pressure.

Apply Fluid

CAUTION

Excessive atomizing air pressure can increase over-spray, reduce transfer efficiency, and result in a poor quality finish. Regulatory agencies in certain states prohibit the operation of a spray gun above 10 psi (69 kPa, 0.7 bar) atomizing air cap pressure.

1. Fill the cup with material. Do not fill past the full markings on cup.
2. Turn on the shop air to the gun. Set atomizing pressure with the gun fully triggered.
3. Adjust the pattern size and shape. See page 7.
4. To achieve the best results when applying fluid:
 - Keep the gun perpendicular and 6 to 8 inches (150 to 200 mm) from the object being sprayed.
 - Use smooth, parallel strokes across the surface to be sprayed with 50% overlap.

 See **Troubleshooting**, page 11, if you experience an irregular pattern.

When using the HVLP spray gun, instead of a conventional airspray gun, you may need to use a slightly slower hand movement and make fewer passes with the gun to coat a part. This is due to the reduced spray velocity produced by lower HVLP air pressures, along with a larger fluid particle size because there is less air to blow off solvents than is produced by conventional airspray. Take care to avoid runs or sags as you spray.

Volatile Organic Compounds (VOC) Regulation

In certain states, spraying solvents that release VOCs into the atmosphere when cleaning a spray gun is prohibited. To comply with these air quality laws, you must use a cleaning method that prevents the escape of VOC vapors into the atmosphere. See **Compliant Cleaning Methods**, page 10.

 Clean air line filters as directed by the manufacturer.

Daily Gun Maintenance



General Tasks

Follow the **Pressure Relief Procedure**, page 8.

- Frequently lubricate the gun moving parts with a drop of non-silicone oil.
- Do not disassemble the spray gun if you are having a spray pattern problem. See **Troubleshooting**, page 11, for information on how to correct the problem.
- Clean the fluid and air line filters daily.
- Check for fluid leakage. Tighten fittings or replace equipment as needed.

CAUTION

Solvent left in gun air passages could result in a poor quality paint finish. Do not use any cleaning method that may allow solvent into the gun air passages.

- Do not point gun up while cleaning it.
- Do not wipe gun with a cloth soaked in solvent; wring out the excess.
- Do not immerse the gun in solvent.

Flush

Flush before using the equipment, before changing colors, and when you are done spraying. Use solvent that is compatible with gun wetted parts and with the fluid that will be sprayed.

 See **Compliant Cleaning Methods**, page 10, to comply with air quality laws if applicable.

1. Follow **Pressure Relief Procedure**, page 8.

2. Dispose of any paint in the cup.
3. Fill the cup with a small amount of solvent.
4. Spray into a grounded metal waste container until the equipment is clean.
5. Follow **Pressure Relief Procedure**, page 8.

Clean Gun and Cup

CAUTION

- Do not submerge gun in solvent. Solvent dissolves lubricant, dries out packings, and clogs air passages.
- Do not use metal tools to clean air cap holes as this may scratch them and distort the spray pattern.
- Use a compatible solvent.

1. Flush, page 9.
2. Dampen a soft cloth with solvent and wring out the excess. Point the gun down and wipe off the outside of the gun and cup.
3. Make sure cup lid vent hole is clear.
4. Blow dry gun inside and out. Lubricate.

 See **Compliant Cleaning Methods**, page 10, to comply with air quality laws if applicable.

Clean Nozzle and Air Cap

1. Remove air cap (13), trigger gun, remove nozzle (11), and soak both in a compatible cleaning solution.

CAUTION
Trigger the gun whenever you tighten or remove the nozzle. This keeps the needle tip away from the nozzle seating surface and prevents the tip from being damaged.

2. Clean air cap, nozzle, and front of the gun with a soft-bristle brush dipped into compatible solvent. Do not use a wire brush or metal tools.
3. Use a soft implement, such as a toothpick, to clean out air cap holes.
4. Trigger the gun while you install the fluid nozzle with the gun tool. Tighten the nozzle securely to 155-165 in-lb (17.5-18.6 N•m) to obtain a good seal.
5. Install the retaining ring (14) and air cap (13).

 When reassembling, make sure the air cap matches the color etched onto the side of the nozzle (gold, brown, grey, blue, etc.).





6. After cleaning the gun, lubricate the following parts with lubricant 111265 daily:
 - fluid control valve threads
 - trigger pivot pin
 - fluid needle shaft

Compliant Cleaning Methods

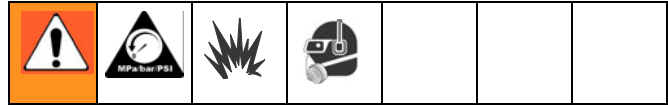
1. Place spray gun in a gun washer that completely encloses the gun and components during cleaning, rinsing, and draining.
2. Spray solvent through the spray gun into a closed gun cleaning station.

Troubleshooting



Problem	Cause	Solution
Spray Pattern  Right	Normal pattern.	No action necessary.
Spray Pattern  Wrong Heavy top or bottom	Dirty or damaged air cap or fluid nozzle.	Rotate air cap 180°. <i>If pattern follows air cap, problem is in air cap (13). Clean and inspect. If pattern is not corrected, replace air cap.</i> <i>If pattern does not follow the air cap, the problem is with the fluid nozzle. Clean and inspect the nozzle. If the pattern is not corrected, replace nozzle.</i>
Spray Pattern  Wrong Split pattern	Pressure too high for viscosity of material being sprayed.	Reduce air pressure and increase material viscosity. Correct pattern by narrowing fan size with fluid control valve (8).
Spray Pattern  Wrong	Dirty or distorted air horn holes.	Clean and inspect air cap. If pattern is not corrected, replace air cap.
Gun spitting	Air getting into paint stream.	Check if cup is empty and fill. Tighten fluid nozzle (11). Check and tighten needle packing nut (17). Check fluid nozzle (11) for damage. Replace fluid inlet gasket (3)
	Damaged fluid nozzle seal (19).	Replace seal (19).
Will not spray	Cup is empty.	Fill cup.
	Fluid control valve (8) turned too far clockwise.	Adjust valve (8) counterclockwise.

Problem	Cause	Solution
Excessive air blowing back	Loose fluid nozzle (11).	Tighten fluid nozzle (11).
	Damaged fluid nozzle seal (19).	Replace seal (19).
Excessive air leak behind trigger.	Worn u-cups/air valve.	Repair gun (Kit 289408). Be sure to use all included parts.
	Worn trigger.	Replace trigger (part 289140). If leak persists repair gun (Kit 289408).

Repair



						
Follow Pressure Relief Procedure , page 8 .						

See **Parts**, page 16, for callout references.

Disassembly

1. Unscrew retaining ring (14) to remove air cap (13b). Check o-rings (13a and 13c) and replace if necessary.
2. Trigger gun while unscrewing nozzle (11) to prevent needle damage.
3. Check o-ring (19) and replace if necessary.
4. Remove fluid control valve (8), spring (26), needle (9), and nut (7). Inspect. Replace tip (9c), needle (9), and u-cup seal (20) as necessary. If replacing needle tip, use low strength thread adhesive on needle tip threads.
5. Remove spring (28) and push the air valve assembly (6) out the back of the gun. Inspect. Replace air valve assembly (6) and u-cup seal (20) as necessary. Use tool (33) to install u-cup seal.
6. Remove trigger nut (22), trigger pin (21), wave washer (18), and trigger (10).
7. Unscrew needle packing nut (17) and remove u-cup packing (16) and spreader (15).
8. Remove air control valve assembly (5). Inspect and replace as necessary.
9. Remove air inlet valve assembly (27). Inspect and replace as necessary.

Fluid Inlet Fitting Replacement

						
PRESSURIZED EQUIPMENT HAZARD						
<ul style="list-style-type: none"> • Fluid inlet gasket (3) must be replaced if fluid inlet fitting (4) is removed from spray gun. • Failure to replace gasket (3) may result in air leakage into the fluid section causing a non-vented gravity cup to become pressurized. 						

1. Remove fluid inlet fitting (4).
2. Remove fluid inlet gasket (3) from gun body and discard.
3. Apply thread sealant to replacement fluid inlet fitting (4) threads.
4. Snap the fluid inlet gasket (3) securely onto the fluid inlet fitting (4).
5. Screw in fluid inlet fitting (4) and torque to 155-165 in.-lb (17.5-18.6 N•m).
6. Replace washer (28) as required.

Reassembly

1. Install air control valve assembly (5) with valve turned fully counterclockwise to outermost position. Torque to 85-90 in-lb (9.6-10.2 N•m).
2. Install air inlet valve assembly (27) with valve turned fully counterclockwise to outermost position. Torque to 205-215 in-lb (23.2-24.3 N•m).
3. Lubricate u-cup spreader (15) and u-cup packing (16). Install spreader (15) with tapered end facing rear of gun. Install u-cup packing (16) with open end facing front of gun. Install packing nut (17). Torque to 3 in-lb (0.3 N•m).
4. Install wave washer (18) with cupped side toward the gun body. Lubricate and apply thread retainer to trigger pin (10). Install trigger (10), trigger pin (21), and trigger nut (22). Torque to 15-20 in-lb (1.7-2.2 N•m).
5. Install air valve assembly (6), spring (28), and nut (7). Torque to 175-185 in-lb (19.8-20.9 N•m).
6. Install needle (9) and spring (26). Lightly lubricate and install fluid control valve (8).
7. Trigger gun while replacing nozzle (11). Torque to 155-165 in-lb (17.5-18.6 N•m).
8. Install air cap assembly (13) and retaining ring (14).

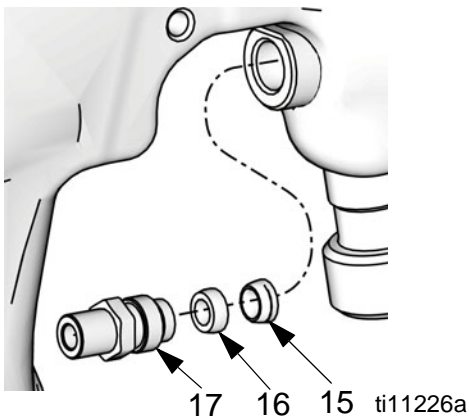

Parts

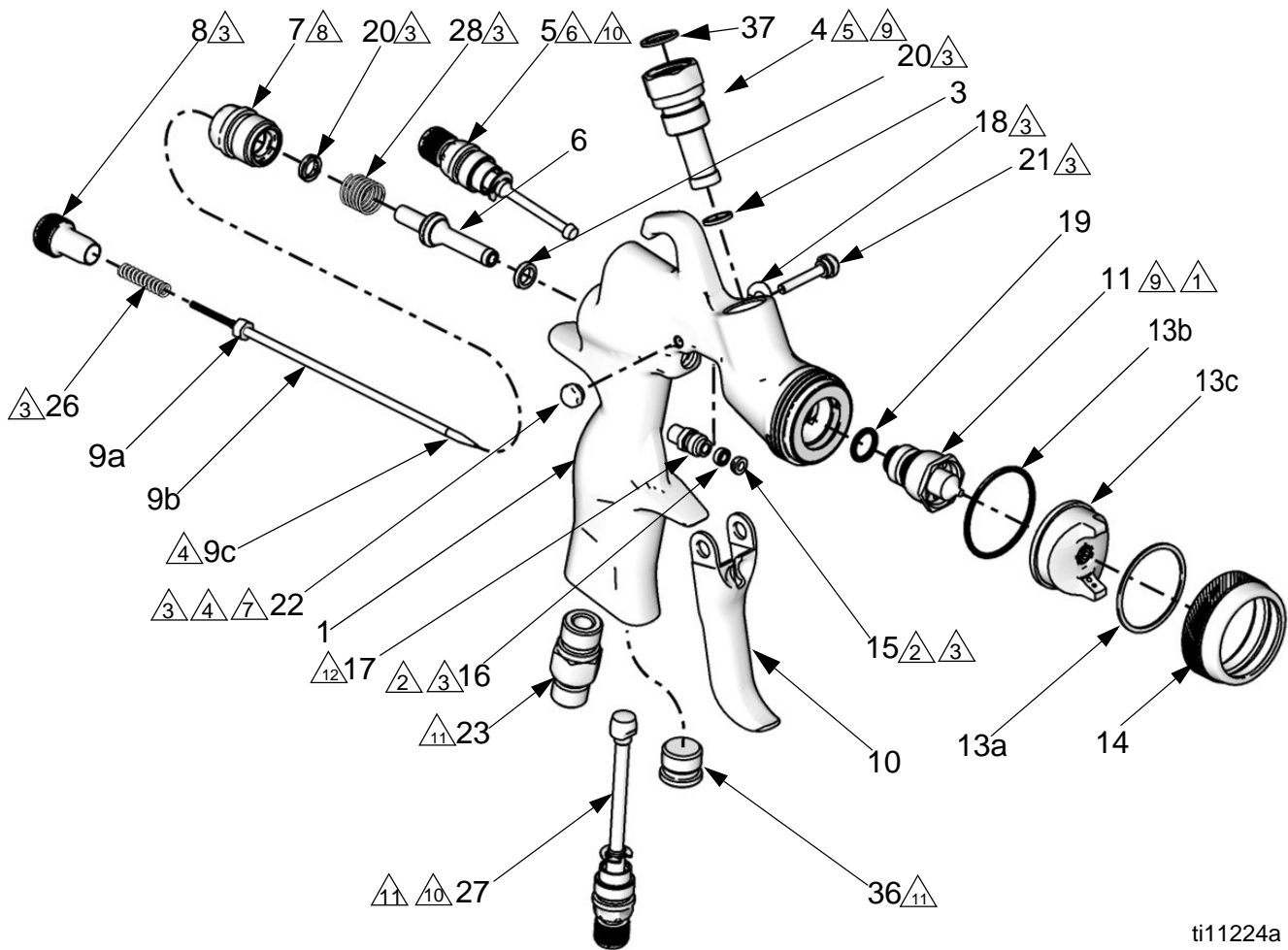

ti11224a

- ① Pull trigger before installing nozzle (11).
- ② Insert spreader (15) with tapered end facing rear of gun. Insert u-cup (16) with open end facing front of gun.
- ③ Apply lubricant.
- ④ Apply low strength thread retainer.
- ⑤ Apply thread sealant.
- ⑥ Torque to 85-90 in-lb (9.6-10.2 N•m).
- ⑦ Torque to 15-20 in-lb (1.7-2.2 N•m).
- ⑧ Torque to 175-185 in-lb (19.8-20.9 N•m).
- ⑨ Torque to 155-165 in-lb (17.5-18.6 N•m).
- ⑩ Install with valve assembly turned fully counterclockwise to outermost position.
- ⑪ Torque to 205-215 in-lb (23.2-24.3 N•m).
- ⑫ Torque to 3 in-lb (0.3 N•m).

Ref.	Part No.	Description	Qty.	Ref.	Part No.	Description	Qty.
1*	---	BODY, gun	1	27	289142	VALVE, assembly, air inlet	1
3*†	---	GASKET, fluid inlet	1	28*	---	SPRING, compression	1
4*	289792	FITTING, fluid inlet, includes gasket (item 3)	1	29	289794	TOOL, gun	1
5	289796	VALVE, air control assembly	1	33*★	---	TOOL, installation, seal	1
6*★	289039	VALVE, air, assembly	1	36	289452	NUT, air plug, not assembled	1
7*	289052	NUT, air valve, u-cup assembly	1	37❖★	---	WASHER, uhmw	1
8	289097	VALVE, fluid control	1	38	289770	CUP, gravity, 650 cc	1
9	See p. 19	NEEDLE, assembly	1	38a	289195	FILTER, cup (not shown)	
9a	---	NUT, needle	1	★ Included in Gun Repair Kit 289790.			
9b	---	NEEDLE	1	❖ Included in Trigger Repair Kit 289143 (contains 5 of each part).			
9c	See p. 19	TIP, needle	1	+ Included in Needle Packing Repair Kit 289455 (contains 5 of each part).			
10	289140	TRIGGER	1	* Included in Air Valve Repair Kit 289408.			
11	See p. 19	NOZZLE, fluid	1	◆ Included in Air Cap Seal Kit 289791 (contains 5 of each part).			
13	See p. 19	AIR CAP, assembly (includes 13a-13c)	1	✓ Included in Retaining Ring Kit 289079.			
13a★◆✓	---	WASHER	1	❖ Included in Cup Gasket Repair Kit 289213 (pack of 10).			
13b★◆✓	---	O-RING	1	* Included in Gun Body Kit 289022.			
13c	See p. 19	AIR CAP	1	† Included in Fluid Inlet Gasket Kit 24A560, package of 5 (purchase separately).			
14✓	---	RING, retaining	1				
15★+	---	SPREADER, u-cup	1				
16★+	---	PACKING, u-cup	1				
17	289793	NUT	1				
18❖	---	WASHER, wave	1				
19★	111457	O-RING	1				
20*	---	PACKING, u-cup	1				
21❖	---	PIN, pivot	1				
22❖	---	NUT, pivot pin	1				
23	289451	FITTING, air inlet	1				
26*	---	SPRING, compression	1				

--- Not sold separately.

Accessories

Cups

Part No. Description

289797	Cup, aluminum, 23 oz (650 cc)
289802	Cup, aluminum, 34 oz (1 liter)
289770	Cup, plastic, 23 oz (650 cc)
192407	Cup Holder

Repair Kits

Part No. Description

289455	Needle Packing Repair Kit
289790	Gun Repair Kit
289791	Air Cap Seal Kit
289143	Trigger Repair Kit
289408	Air Valve Repair Kit
289213	Cup Gasket Kit, 10 pack
289079	Retaining Ring Kit
289022	Gun Handle Replacement Kit
24A560	Fluid Inlet Gasket Kit, 5 pack
24C310	Nozzle O-Ring Kit, 5-pack
195065	Steel Air Inlet Fitting

Air Valves

Part No. Description

234784	Air Control Valve with Gauge
235119	Gun Air Regulator Assembly
239655	Swivel Air Valve

Cleaning Kit

Part No. Description

105749	Cleaning Brush
111265	Gun Lubricant
15C161	Ultimate Gun Cleaning Kit

3M™ PPS™ Cups and Accessories

Part No. Description

234941	Cup and Collar, 6 oz, 8-pack
234771	Cup and Collar 25 oz, 8-pack
234937	Cup and Collar 32oz, 4-pack
234940	Lid and Liner, 6 oz, 50-pack
234772	Lid and Liner, 25 oz, 50-pack
234938	Lid and Liner, 32 oz, 25-pack
234942	Ratio Film, insert, 6 oz, 50-pack
15F531	Ratio Film, insert, 25 oz, 100-pack
234939	Ratio Film, insert, 32 oz, 100-pack
289486	Gravity Cup Assembly, 25 oz, includes cup, collar, lid, liner, and adapter
289795	Gravity Feed Adapter
15E470	Lid Dispenser
15E469	Liner Dispenser
15E467	Gun Tray

Test Gauge

Part No. Description

289803	HVLP Verification
--------	-------------------

Hoses

Part No. Description

239631	4 ft Air Whip Hose Assembly (5/16 in.)
239636	15 ft Air Hose Assembly (5/16 in.)
239637	25 ft Air Hose Assembly (5/16 in.)

Tips

Part No. Description

24E484	.030 SST Needle Tips (Pack of 5)
--------	----------------------------------

Repair Kits

Without Gravity Cup

Model	Spray Type	Nozzle Size in. (mm)	Air Cap Kit (13a-13c)	Nozzle Kit (11, 19)	Needle Assembly Kit (9a-9c)	Needle/ Nozzle Kit (9a-9c, 11, 19)	Needle Tip Kit (9c, 5-pack)
289002	Conventional	0.055 (1.4)	289773	289780	289799	289493	288185
289003	Conventional	0.070 (1.8)	289773	289767	289786	289494	289001
289005	HVLP	0.055 (1.4)	289771	289776	289786	289495	289001
289006	HVLP	0.070 (1.8)	289771	289801	289786	289496	289001
289008	Compliant	0.055 (1.4)	289772	289779	289799	289497	288185
289009	Compliant	0.070 (1.8)	289772	289559	289799	289498	288185

With Gravity Cup

Model	Spray Type	Nozzle Size in. (mm)	Air Cap Kit (13a-13c)	Nozzle Kit (11, 19)	Needle Assembly Kit (9a-9c)	Needle/ Nozzle Kits (9a-9c, 11, 19)	Needle Tip Kit (9c, 5-pack)
289011	Conventional	0.055 (1.4)	289773	289780	289799	289493	288185
289012	Conventional	0.070 (1.8)	289773	289767	289786	289494	289001
289014	HVLP	0.055 (1.4)	289771	289776	289786	289495	289001
289015	HVLP	0.070 (1.8)	289771	289801	289786	289496	289001
289017	Compliant	0.055 (1.4)	289772	289779	289799	289497	288185
289018	Compliant	0.070 (1.8)	289772	289559	289799	289498	288185

With 3M PPS Cup

Model	Spray Type	Nozzle Size in. (mm)	Air Cap Kit (13a-13c)	Nozzle Kit (11, 19)	Needle Assembly Kit (9a-9c)	Needle/ Nozzle Kits (9a-9c, 11, 19)	Needle Tip Kit (9c, 5-pack)
289020	Conventional	0.055 (1.4)	289773	289780	289799	289493	288185
289021	Conventional	0.070 (1.8)	289773	289767	289786	289494	289001
289023	HVLP	0.055 (1.4)	289771	289776	289786	289495	289001
289024	HVLP	0.070 (1.8)	289771	289801	289786	289496	289001
289026	Compliant	0.055 (1.4)	289772	289779	289799	289497	288185
289027	Compliant	0.070 (1.8)	289772	289559	289799	289498	288185

Needle Tips

Grooves	Needle Tip Kit (5-pack)
4	288185
7	289001

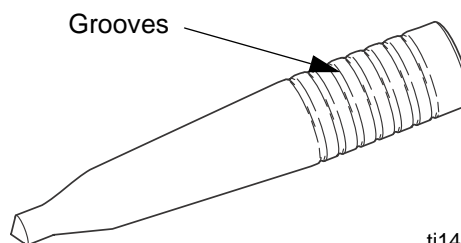

ti14043a

Technical Data

Maximum Air Inlet Pressure	100 psi (0.7 MPa, 7 bar)
Maximum HVLP/Compliant Inbound Air Pressure:	
HVLP gravity feed	29 psi (0.2 MPa, 2.0 bar)*
Compliant gravity feed	35 psi (0.24 MPa, 2.4 bar)*
Air Consumption:	
Conventional Gun	13.3 CFM at 43 psi (0.3 MPa, 3.0 bar)
HVLP Gun	14.4 CFM at 29 psi (0.2 MPa, 2.0 bar)
Compliant Gun	11.2 CFM at 35 psi (0.24 MPa, 2.4 bar)
Fluid and Air Operating Temperature Range	32°F to 109°F (0°C to 43°C)
Spray Gun:	
Air Inlet	1/4 npsm (R1/4-19)
Weight with cup	1.3 lbs (0.6 kg)
Sound Data:	
Conventional	
Sound pressure at 43 psi (0.3 MPa, 3.0 bar)	79.52 dB(A)**
Sound power at 43 psi (0.3 MPa, 3.0 bar)	88.05 dB(A)**
HVLP	
Sound pressure at 29 psi (0.2 MPa, 2.0 bar)	83.9 dB(A)**
Sound power at 29 psi (0.2 MPa, 2.0 bar)	90.8 dB(A)**
Compliant	
Sound pressure at 35 psi (0.24 MPa, 2.4 bar)	81.8 dB(A)**
Sound power at 35 psi (0.24 MPa, 2.4 bar)	88.7 dB(A)**
Gravity Cup Size	23 oz (0.68 liter) cup
Wetted Parts	303 stainless steel, 17-4 PH stainless steel, PEEK, acetal, UHMWPE

* Produces 10 psi (0.07 MPa, 0.7 bar) spraying pressure at air cap.

** All readings were taken with the fan valve fully open (fan full size) at the assumed operator position. Sound power was tested per ISO 9614-2.

Graco Standard Warranty

Graco warrants all equipment referenced in this document which is manufactured by Graco and bearing its name to be free from defects in material and workmanship on the date of sale to the original purchaser for use. With the exception of any special, extended, or limited warranty published by Graco, Graco will, for a period of twelve months from the date of sale, repair or replace any part of the equipment determined by Graco to be defective. This warranty applies only when the equipment is installed, operated and maintained in accordance with Graco's written recommendations.

This warranty does not cover, and Graco shall not be liable for general wear and tear, or any malfunction, damage or wear caused by faulty installation, misapplication, abrasion, corrosion, inadequate or improper maintenance, negligence, accident, tampering, or substitution of non-Graco component parts. Nor shall Graco be liable for malfunction, damage or wear caused by the incompatibility of Graco equipment with structures, accessories, equipment or materials not supplied by Graco, or the improper design, manufacture, installation, operation or maintenance of structures, accessories, equipment or materials not supplied by Graco.

This warranty is conditioned upon the prepaid return of the equipment claimed to be defective to an authorized Graco distributor for verification of the claimed defect. If the claimed defect is verified, Graco will repair or replace free of charge any defective parts. The equipment will be returned to the original purchaser transportation prepaid. If inspection of the equipment does not disclose any defect in material or workmanship, repairs will be made at a reasonable charge, which charges may include the costs of parts, labor, and transportation.

THIS WARRANTY IS EXCLUSIVE, AND IS IN LIEU OF ANY OTHER WARRANTIES, EXPRESS OR IMPLIED, INCLUDING BUT NOT LIMITED TO WARRANTY OF MERCHANTABILITY OR WARRANTY OF FITNESS FOR A PARTICULAR PURPOSE.

Graco's sole obligation and buyer's sole remedy for any breach of warranty shall be as set forth above. The buyer agrees that no other remedy (including, but not limited to, incidental or consequential damages for lost profits, lost sales, injury to person or property, or any other incidental or consequential loss) shall be available. Any action for breach of warranty must be brought within two (2) years of the date of sale.

GRACO MAKES NO WARRANTY, AND DISCLAIMS ALL IMPLIED WARRANTIES OF MERCHANTABILITY AND FITNESS FOR A PARTICULAR PURPOSE, IN CONNECTION WITH ACCESSORIES, EQUIPMENT, MATERIALS OR COMPONENTS SOLD BUT NOT MANUFACTURED BY GRACO. These items sold, but not manufactured by Graco (such as electric motors, switches, hose, etc.), are subject to the warranty, if any, of their manufacturer. Graco will provide purchaser with reasonable assistance in making any claim for breach of these warranties.

In no event will Graco be liable for indirect, incidental, special or consequential damages resulting from Graco supplying equipment hereunder, or the furnishing, performance, or use of any products or other goods sold hereto, whether due to a breach of contract, breach of warranty, the negligence of Graco, or otherwise.

FOR GRACO CANADA CUSTOMERS

The Parties acknowledge that they have required that the present document, as well as all documents, notices and legal proceedings entered into, given or instituted pursuant hereto or relating directly or indirectly hereto, be drawn up in English. Les parties reconnaissent avoir convenu que la rédaction du présente document sera en Anglais, ainsi que tous documents, avis et procédures judiciaires exécutés, donnés ou intentés, à la suite de ou en rapport, directement ou indirectement, avec les procédures concernées.

Graco Information

For the latest information about Graco products visit www.graco.com.

TO PLACE AN ORDER, contact your Graco distributor or call to identify the nearest distributor.
Phone: 612-623-6921 or Toll Free: 1-800-328-0211 Fax: 612-378-3505

All written and visual data contained in this document reflects the latest product information available at the time of publication. Graco reserves the right to make changes at any time without notice.

Original instructions. This manual contains English. MM 312579

Graco Headquarters: Minneapolis
International Offices: Belgium, China, Japan, Korea

GRACO INC. AND SUBSIDIARIES • P.O. BOX 1441 • MINNEAPOLIS MN 55440-1441 • USA
Copyright 2007, Graco Inc. All Graco manufacturing locations are registered to ISO 9001.

www.graco.com
Revised 10/2011