

Repair Parts for Xtreme™ and XP Xtreme 115cc Lower

406889H

EN



Important Safety Instructions

Read all warnings and instructions in manual 311762. Save those instructions.

25D233 - Complete Repair Kit, Graco Formulated UHMWPE/Leather
(Abrasive Applications - General Use)

25D243 - Complete Repair Kit, Graco Formulated PTFE
(Chemical Resistance and Higher Temperatures)

25D257 - Complete Repair Kit, Graco Formulated UHMWPE/PTFE
(Chemical Resistance and Durability)

Bulk Pack Replacement Parts

Non-filter models do not use items 122, 125, and 159.

- Torque to 115-135 ft-lb (155-182 N•m)
- Torque to 75 ft-lb (100 N•m).
- Torque to 135-150 ft-lb (183-203 N•m)
- Torque to 40-60 ft-lb (52-82 N•m)
- Apply lubricant to threads before assembly.
- Lubricate
- Circular grooves on top filter caps (not included) indicates pump series. See page 3 for detailed information.
- 8. Thick, medium, and thin refers to the relative cross-section thickness of the o-rings.
- Pumps with 3 in. (76.2 mm) filters can be upgraded with 5.65 in. (143.5 mm) filters from kit 24F975.

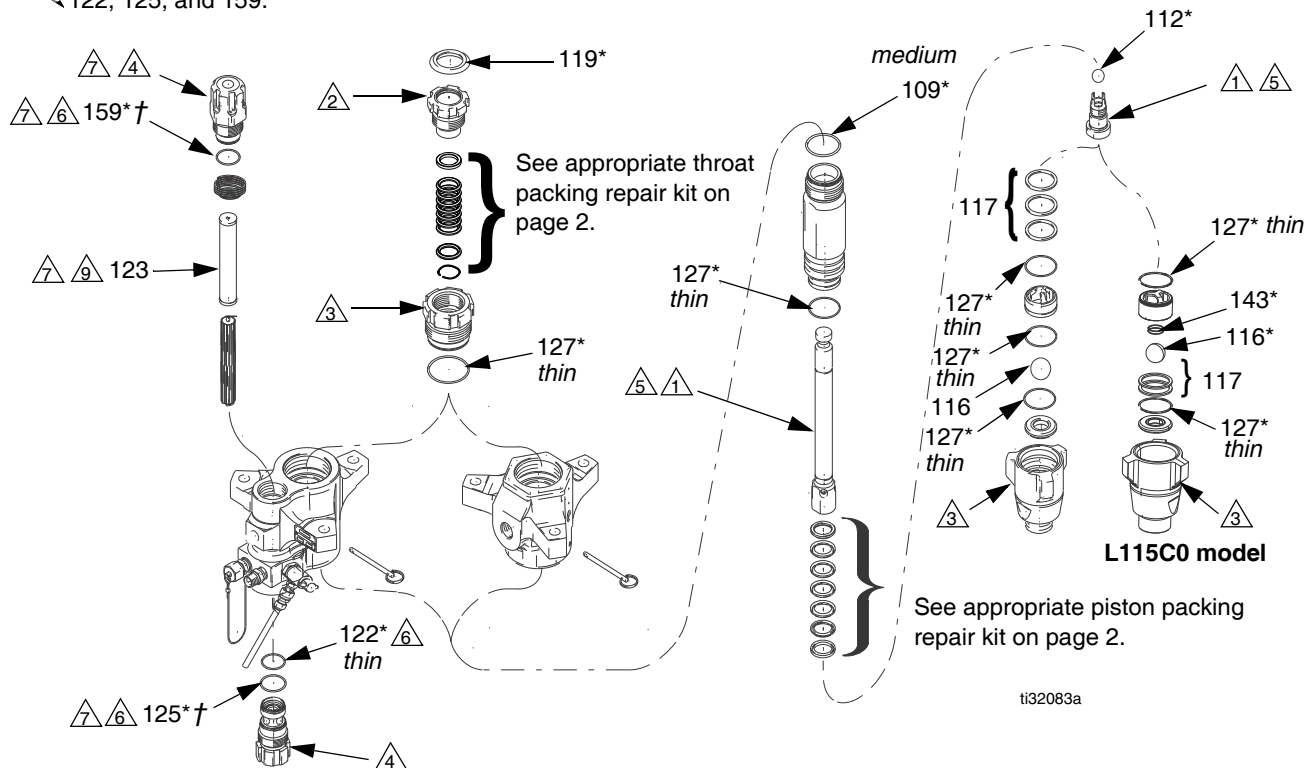

Bulk Pack Replacement Parts

Ref.	Part	Description	Qty.
103*	---	THROAT PACKINGS	1
104*	---	PISTON PACKINGS	1
109*	288067	O-RING, PTFE, top cylinder; medium	1
		(10/pack)	
112*	288065	BALL, piston (3/pack)	1
116*	244899	BALL, inlet (3/pack)	1
117	288064	SHIM, inlet, ball guide (9/pack)	2 or 3
119*	247393	PLUG, throat seal (10/pack)	1
122*	244895	O-RING, filter; thin, PTFE	1
		(10/pack)	
123	224458	STRAINER, 30 mesh screen	1
		5.65 in. (143.5 mm) (2/pack)	
123	238436	STRAINER, 30 mesh screen,	1
		5.65 in. (143.5 mm) (25/pack)	
123	238438	STRAINER, 60 mesh screen	1
		5.65 in. (143.5 mm) (25/pack)	
123	224459	STRAINER, 60 mesh screen,	1
		5.65 in. (143.5 mm) (2/pack)	
125*	262484	O-RING, lower cap (10/pack)	1
	244896	For Series A pumps (10/pack)	1
127*	288068	O-RING, PTFE, thin(10/pack)	4 or 5
143*	124007	SPRING, foot valve; 262508 and	1
		262790 only	
159*	262483	O-RING, top cap (10 pack)	1
	244895	For Series A pumps (10/pack)	1

* Included in Seal Repair Kits.

† See page 3 to match correct o-ring with pump series. Discard unused o-rings; they do not fit different series pumps.

Thick, medium, and thin refers to the relative cross-section thickness of the o-rings.

NOTE: The L115C0 model uses a 30 mesh filter.

Complete Repair Kit 25D243* (Graco Formulated PTFE)

(*includes items shown in replacement parts table.
NOTE: Throat and Piston Packings are the same.)

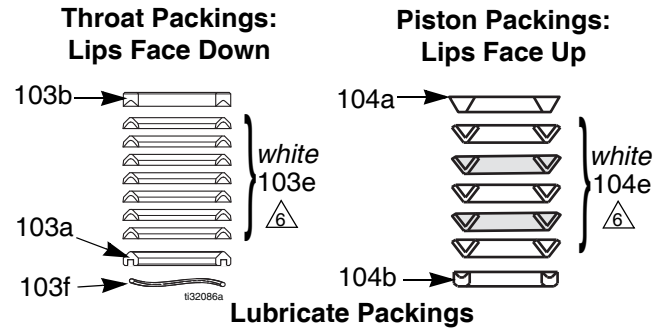

Throat Seal Repair Kit 25D150 (PTFE)

Includes:

Ref.	Description	Qty.
103a	GLAND, male, throat	1
103b	GLAND, female, throat	1
103e	V-PACKING, PTFE, throat (white)	7
103f	WAVE SPRING	1

Piston Seal Repair Kit 25D160 (PTFE)

Includes:

Ref.	Description	Qty.
104a	GLAND, male, piston	1
104b	GLAND, female, piston	1
104e	V-PACKING, PTFE, piston (white)	5

Complete Repair Kit 25D233*
Graco Formulated UHMWPE/Leather
 (*includes items shown in replacement parts table.)
NOTE: Throat and Piston Packings are the same.)

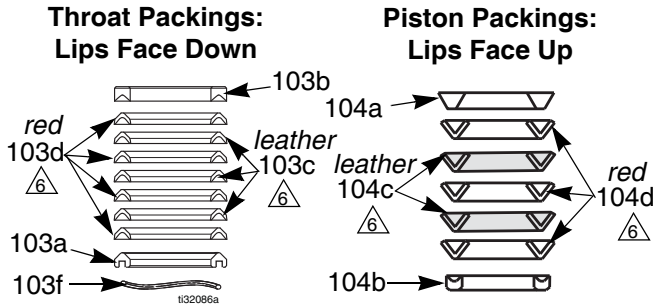

Lubricate Packings
 (soak leather packings in oil for 1 hour)

Complete Repair Kit 25D257*
Graco Formulated UHMWPE/PTFE
 (*includes items shown in replacement parts table.)
NOTE: Throat and Piston Packings are the same.)

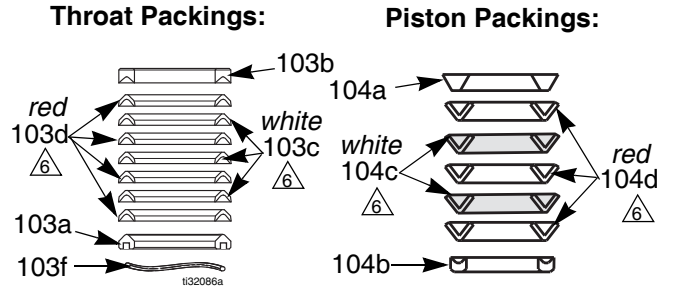

Lubricate Packings

Throat Seal Repair Kit 25D133
Graco Formulated UHMWPE/Leather

Includes:

Ref.	Description	Qty.
103a	GLAND, male, throat	1
103b	GLAND, female, throat	1
103c	V-PACKING, leather, throat	3
103d	V-PACKING, UHMWPE, throat (red)	4
103f	WAVE SPRING	1

Piston Seal Repair Kit 25D140
Graco Formulated UHMWPE/Leather

Includes:

Ref.	Description	Qty.
104a	GLAND, male, piston	1
104b	GLAND, female, piston	1
104c	V-PACKING, leather, piston	2
104d	V-PACKING, UHMWPE, piston (red)	3

Throat Seal Repair Kit 25D174
Graco Formulated UHMWPE/PTFE

Includes:

Ref.	Description	Qty.
103a	GLAND, male, throat	1
103b	GLAND, female, throat	1
103c	V-PACKING, PTFE, throat (white)	3
103d	V-PACKING, UHMWPE, throat (red)	4
103f	WAVE SPRING	1

Piston Seal Repair Kit 25D188
Graco Formulated UHMWPE/PTFE

Includes:

Ref.	Description	Qty.
104a	GLAND, male, piston	1
104b	GLAND, female, piston	1
104c	V-PACKING, PTFE, piston (white)	2
104d	V-PACKING, UHMWPE, piston (red)	3

O-ring Chart

The pump series for all Xtreme and XP lowers are identified by the circular grooves on the top filter cap. Use the chart below to match the correct o-rings when rebuilding the pump.

The original filter cap seals were changed in 2010 for improved sealing. The o-rings are not interchangeable between different series filter caps. See **24F975 Filter Cap Conversion Kit**, page 4.

Note: The top filter cap is shown (not included in the repair kit). O-rings below are shown at actual size.

Series A

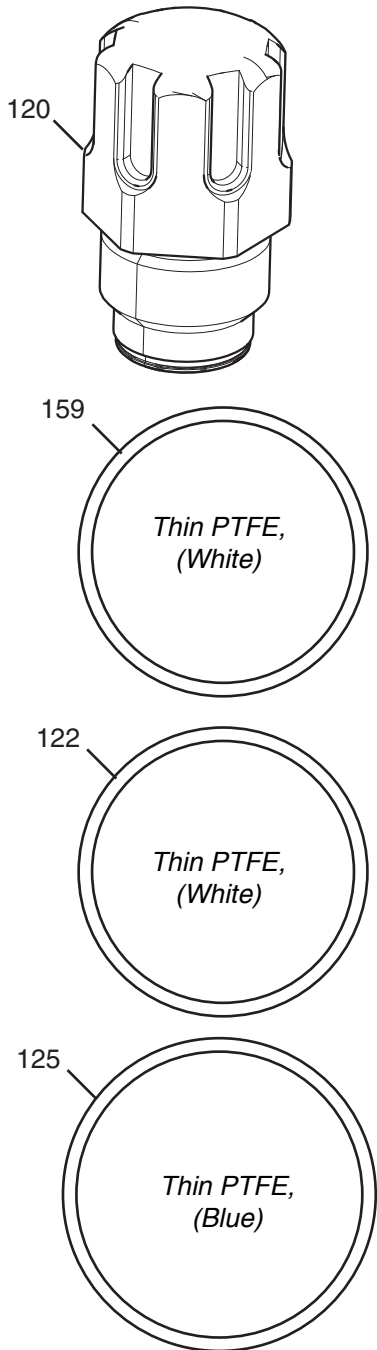

Series B

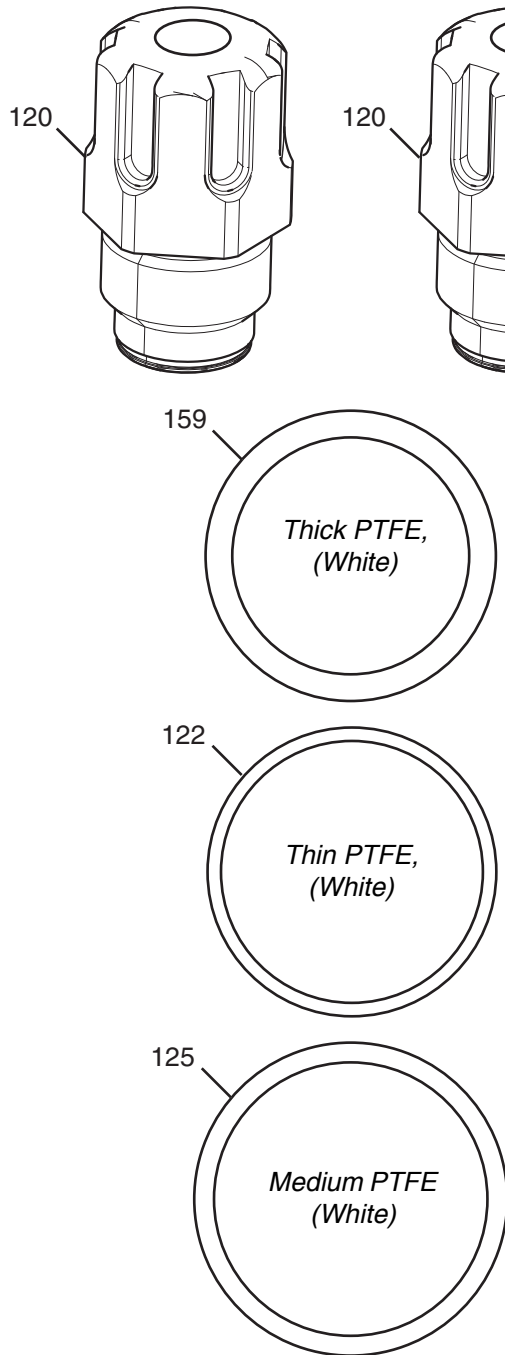

Series C

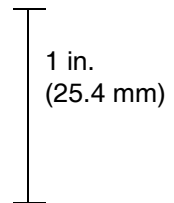
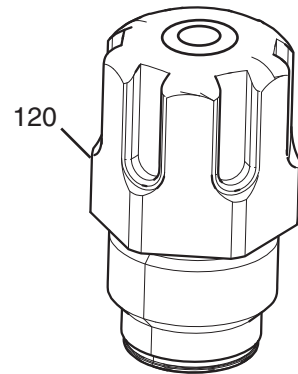

24F975 Filter Cap Conversion Kit

Purchase **24F975 Filter Cap Conversion Kit** to improve sealing of Series A filters. Includes components shown. See manual 406882 for more information.

Benefits:

- Compatible with all sizes.
- Improves sealing
- Ensures filters are installed correctly

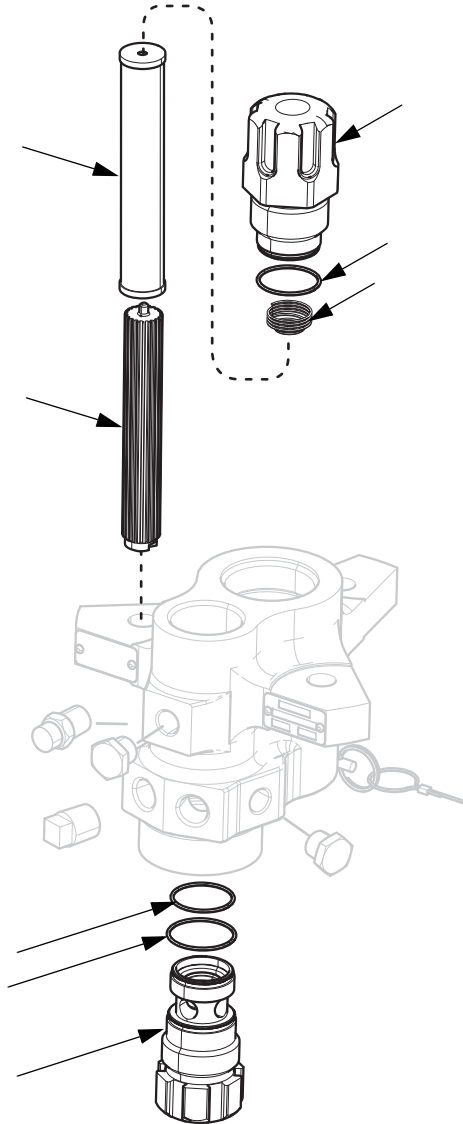

*All written and visual data contained in this document reflects the latest product information available at the time of publication.
Graco reserves the right to make changes at any time without notice.*

For patent information, see www.graco.com/patents.

Original instructions. This manual contains English. MM 406889

Graco Headquarters: Minneapolis

International Offices: Belgium, China, Japan, Korea

GRACO INC. AND SUBSIDIARIES • P.O. BOX 1441 • MINNEAPOLIS MN 55440-1441 • USA
Copyright 2010, Graco Inc. All Graco manufacturing locations are registered to ISO 9001.

www.graco.com

Revision H, September 2018