



6.3

# Proportional pressure relief valve

## Type DBE(E)/DBEM(E)...30

Sizes 10, 25 and 32  
Up to 315 bar  
Up to 600 L/min

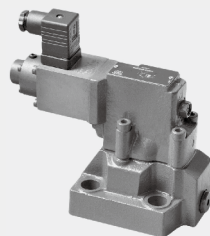

### Contents

Function and configuration	02
Ordering code	03
Symbols	03
Technical data	04
Electrical data	04
Characteristic curves	05-06
Unit dimensions	07-09

### Features

- Sub-plate mounting:
- Porting pattern to DIN 24 340 form E and ISO 6264
- For installation in manifolds
- 4 pressure ratings
- Max. pressure limitation , optional
- Amplifier type VT-2000 (must be ordered separately)

## Function and configuration

DBE valves are pilot operated pressure relief valves. They are used to continuously set the pressure in hydraulic systems by electrical signal.

Basically these valves consist of a pilot valve (1) with proportional solenoid (2) and the main valve (3) with main spool insert (4).

### Type DBE...

The pressure limit is in relation to the electrical current value and set by the proportional solenoid (2). The system pressure is applied to the main spool (4). At the same time the pressure is applied to the spring loaded side of the main spool (4) and the pilot poppet (6) via orifice (5) at the pilot valve (1). If the hydraulic force exceeds the solenoid force, the pilot poppet (6) opens. Pilot fluid can flow back to tank and pressure drop caused by the orifices effects the main spool (4). Then main spool (4) opens the channel from pump to tank.

### Type DBEM...

Optionally the valve can be supplied with an additional spring loaded pilot control valve (7) for maximum pressure safety (redundant pressure safety).

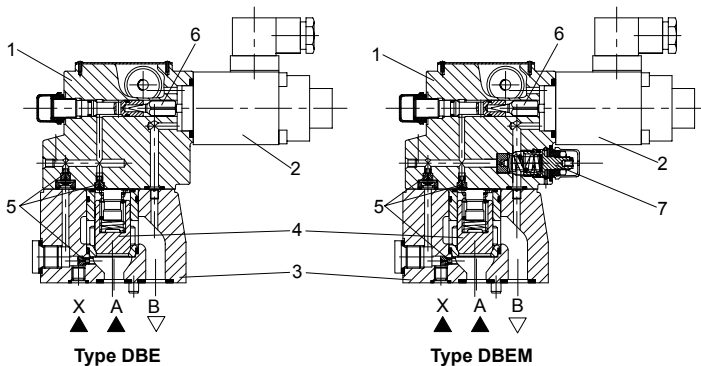

## Ordering code

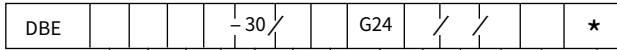

Without maximum pressure safety =No code  
 With maximum pressure safety =M

Pilot operated =No code  
 Pilot operated valve with main spool (enter nom. size 30) =C  
 Pilot operated valve without main spool (do not enter nom. size) =C  
 Pilot operated valve for remote controlling =T

For external control electronics =No code  
 With integrated electronics (OBE) =E

Nominal size 10 = 10  
 Nominal size 25 = 20  
 Nominal size 32 = 30

Series 30 = 30

Max. pressure 50 bar = 5  
 Max. pressure 100 bar = 10  
 Max. pressure 200 bar = 20  
 Max. pressure 315 bar = 31.5

Further information in plain text

V= FKM seals  
 No code=NBR seals

Pilot oil drain port Y  
 No code= Inch threaded  
 2= Metric threaded

For type DBE(M)E:  
 A1= Command/actual value 0-10V  
 F1= Command/actual value 4 to 20 mA

For type DBE(M)E:  
 K31 = With component plug,  
 Without plug-in connector  
 Z31 = With component plug  
 and plug-in connector

For type DBE(M)E, Supply voltage:  
 G24= +24VDC

Y= Pilot oil supply internal and drain external  
 Not for DBE(M)(E)C and DBE(M)(E)T  
 without main spool

XY= Pilot oil supply external and drain external  
 (only for with the pilot valve and main spool)

06

## Symbols

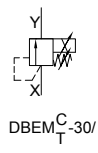
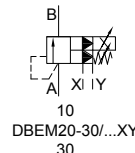
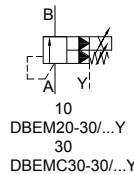
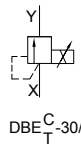
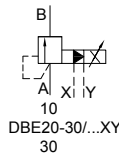
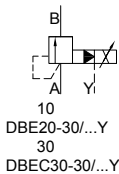

## Technical data

Fluid	Mineral oil suitable for NBR and FKM seal Phosphate ester for FKM seal			
Fluid temperature range	°C	-30 to +80 (NBR seal) -20 to +80 (FKM seal)		
Viscosity range	mm <sup>2</sup> /s	2.8 to 380		
Degree of contamination	Maximum permissible degree of fluid contamination: Class 9. NAS 1638 or 20/18/15, ISO4406			
Max. operating pressure Port A, B, X	bar	315		
Max. setting pressure	bar	50; 100; 200; 315		
Min. setting pressure	In relation to Flow (Q), see characteristic curves			
Pressure at zero command value	= min. setting pressure			
Return oil pressure port Y	bar	Separate and at zero pressure to tank		
Max. pressure safety (infinitely adjustable)	setting pressure	Pressure range under Max. safety pressure		
	50 bar	10-60 <sup>+20</sup> bar		
	100 bar	10-120 <sup>+20</sup> bar		
	200 bar	10-220 <sup>+20</sup> bar		
	315 bar	10-340 <sup>+20</sup> bar		
Max. pressure safety setting condition	When rated pressure is 50 bar, between 60 bar and 80 bar			
	When rated pressure is 100 bar, between 120 bar and 140 bar			
	When rated pressure is 200 bar, between 220 bar and 240 bar			
	When rated pressure is 315 bar, between 340 bar and 360 bar			
Nominal size		10	25	32
Max. flow-rate	L/min	200	400	600
Pilot oil (for pilot valve)	L/min	0.7 to 2		
Linearity	±3.5%			
Repeatability	<±2%			
Hysteresis	with shimmy		without shimmy	
	±1.5% P max (200Hz, amplitude 200mAssl)		±4.5% P max	
Shifting time	30~150ms (independent with the system)			

## Electrical data

Power source	DC	
Min. solenoid current	mA	100
Max. solenoid current	mA	800
Coil resistance	19.5Ω at 20°C, Max. warm value: 28.8Ω	
Working status	Continuous	
Max. working environmental temperature	+50°C	
Electrical connection	Plug-in connector to DIN EN 175301-803/ISO 4400	
Insulation to DIN 40 050	IP 65	
Ampilfier	VT2000	

# Characteristic curves

(Measured at  $\theta_{oil}=40^{\circ}\text{C} \pm 5^{\circ}\text{C}$ , using HLP46)

Operating pressure in relation to the flow

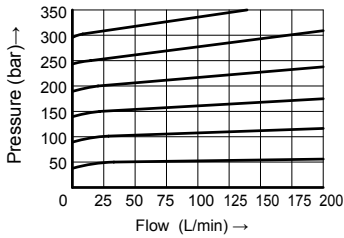

**DBE10**

Min. setting pressure in relation to the flow

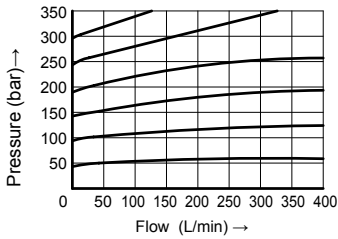
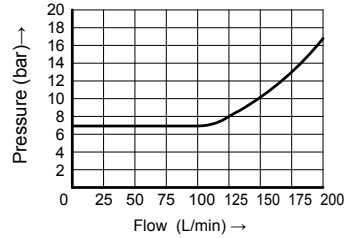

**DBE20**

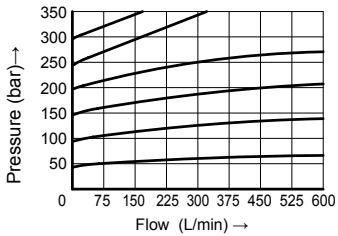
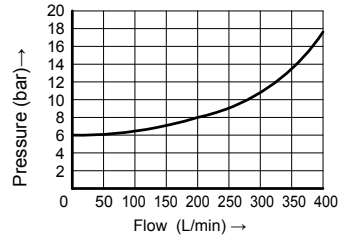

**DBE30**

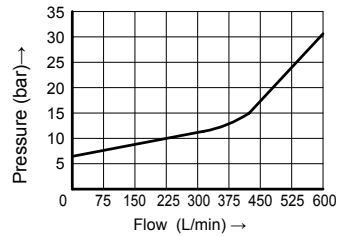

### Characteristic curves

(Measured at  $\vartheta_{oil}=40^{\circ}\text{C} \pm 5^{\circ}\text{C}$ , using HLP46)

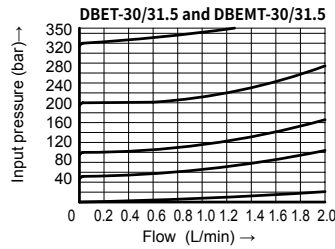
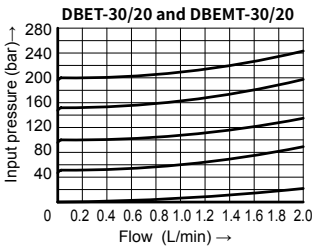
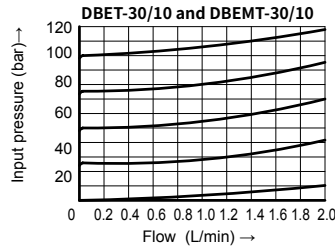
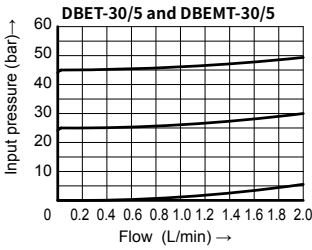

#### Inputting pressure/current demand curve type DBE10, 20 and 30/DBET

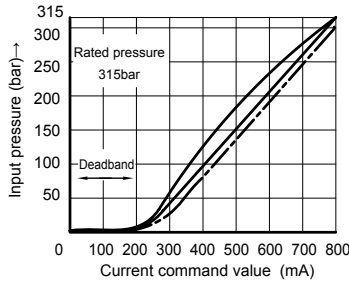
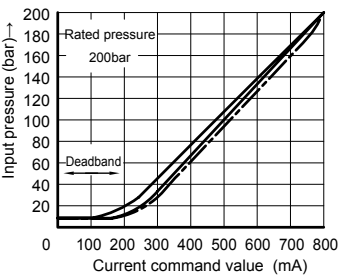
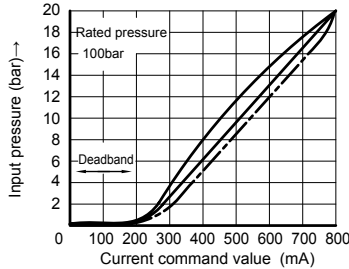
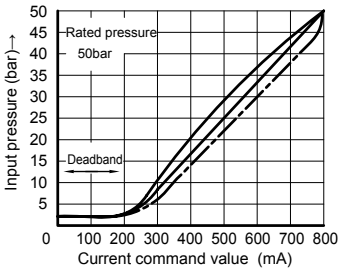

Measured under flow 27L/min of type DBE10, 20 and 30.  
Measured under flow 0.8L/min of type DBET.

#### Hysteresis

With shimmy —————  
Without shimmy - - - - -

**Note:** To get min. preset pressure, pilot current is not permitted to exceed 100mA.

# Unit dimensions

(Dimensions in mm)

## Pressure relief valve of type DBE/DBEM

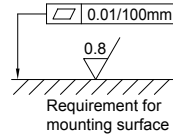
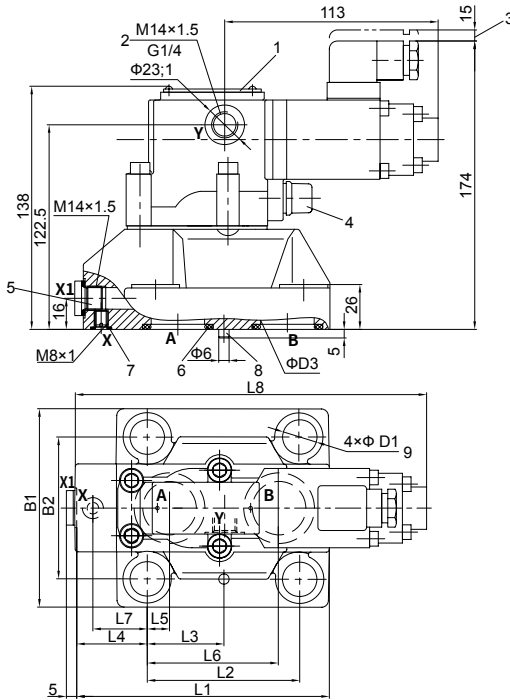

- 1 Name plate
- 2 (Port Y) pilot oil drain always external and separate to tank at zero pressure.
- 3 Space required to remove plug-in connector.
- 4 Max. pressure limitation
- 5 External pilot supply (X and X1, optional)
- 6 O-ring (port A and B)
- 7 O-ring 9.25 × 1.78 (port X)
- 8 Locating pin
- 9 Fixing screw hole

### Valve fixing screws:

Internal hexagon screw GB/T 70.1-10.9,

**DBE/DBEM10:** M12 × 45, tightening torque,  $M_t=130$  Nm

**DBE/DBEM20:** M16 × 50, tightening torque,  $M_t=310$  Nm

**DBE/DBEM30:** M18 × 50, tightening torque,  $M_t=430$  Nm

Type	B1	B2	Weight	O-ring (Port A and port B)		
DBEM DBE 10	10	78	53.8	4.4kg	17.12 × 2.62	
DBEM DBE 20	100	70	4.8kg	28.17 × 3.53		
DBEM DBE 30	115	82.6	7.1kg	34.52 × 3.53		
Type	L1	L2	L3	L4	L5	L6
DBEM DBE 10	91	53.8	22.1	27.5	22.1	47.5
DBEM DBE 20	116	66.7	33.4	33.3	11.1	55.6
DBEM DBE 30	147.5	88.9	44.5	41	12.7	76.2
Type	L7	L8	D1	D2	D3	D4
DBEM DBE 10	0	176.5	14	M12	6	12
DBEM DBE 20	23.8	190	18	M16	6	22
DBEM DBE 30	31.8	200	20	M18	7	30

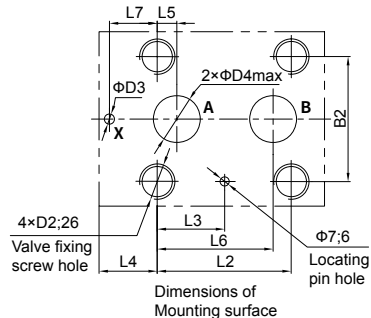

## Unit dimensions

(Dimensions in mm)

### Plug-in valve

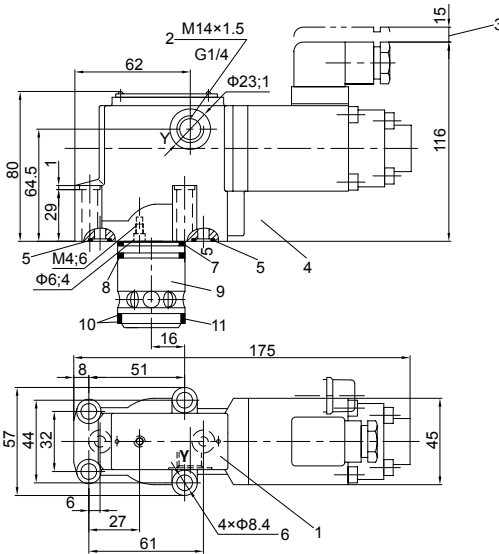

- 1 Name plate
- 2 (Port Y) pilot oil drain always External and separate to tank at zero pressure
- 3 Space required to remove plug-in connector
- 4 Max. pressure limitation
- 5 O-ring 9.25×1.78( port X and Y)
- 6 Fixing screw hole
- 7 O-ring 28×2.65
- 8 O-ring 28×1.8
- 9 Main spool assembly
- 10 Retaining ring 28.4×32×0.8
- 11 O-ring 27.3×2.4
- 12 Retaining ring and O-ring shall be fixed onto the hole before fixing the main spool
- 13 The throttle shall be ordered separately

06

Size	D1	D2	D3	Main spool assembly code		Valve fixing screw	Tighting touque	Weight
10	10	40	10	307341 (NBR)	307342 (FKM)	4-M8×40 internal hexagon GB/T70.1-10.9	20Nm	2.9kg
20	25	45	25					
30	32	45	32					

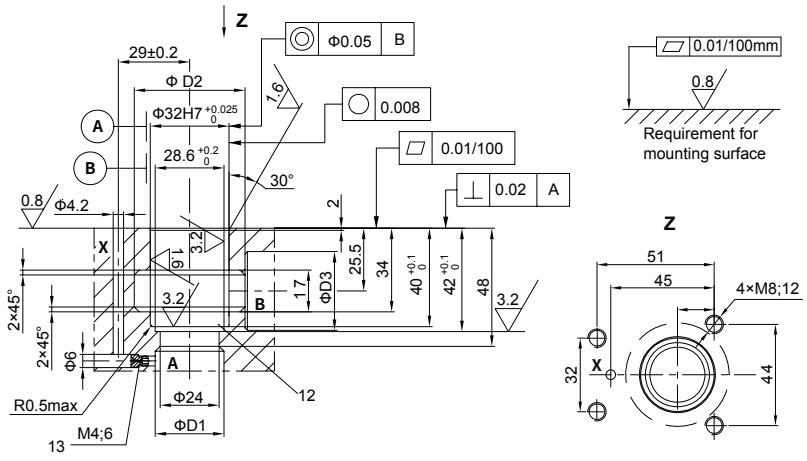



## Unit dimensions

(Dimensions in mm)

**Pressure relief valve as remote controller of valve type DBET/DBEMT  
Pilot valve without main spool assembly of valve type DBEC/DBEMC**

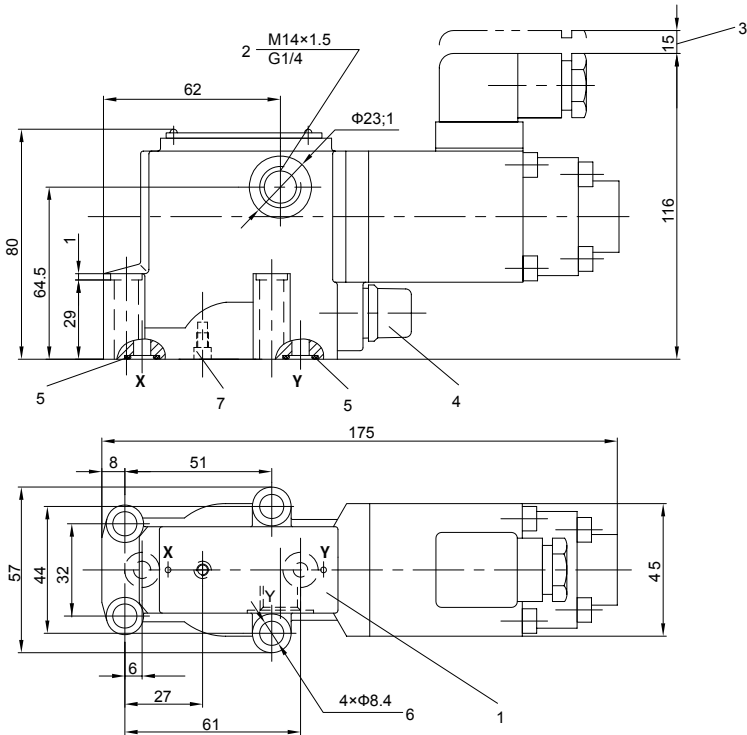

- 1 Name plate
- 2 Pilot oil drain port, optional
- 3 Space required to remove plug-in connector
- 4 Max. pressure limitation
- 5 O-ring 9.25×1.78 (port X and Y)
- 6 Fixing screw hole
- 7 Blocked up in valve type DBET/DBEMT  
Fixed with throttle hole in valve type DBEC/DBEMC
- 8 Pilot oil drain port, optional

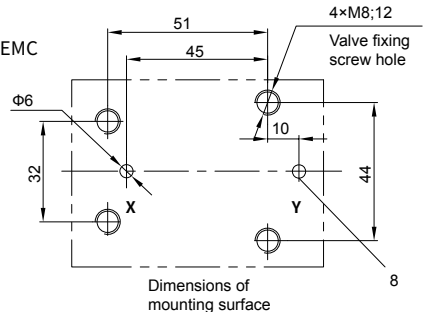
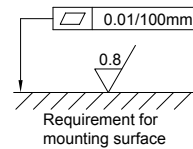

### Valve fixing screws:

Internal hexagon screw  
GB/T 70.1-10.9, 4-M8×40  
Tightening torque  $M_A=20Nm$