

Humphrey Super Quick Exhaust Valves

Humphrey Super Quick Exhaust valves feature a special molded shuttle designed especially for quick exhaust service. The shuttle's full-formed seating surface provides long cycle life and outperforms the flat-disk (sheet stock) diaphragms found in competitive valve designs. Because of its shuttle design, the Humphrey Super Quick Exhaust valve does not require the flow-restricting metal body webbing used in flat-disk designs. There are many practical uses for these low-cost Super Quick Exhaust valves, and there is a size for virtually every need, with pipe ports from #10-32 to 3/4-inch.

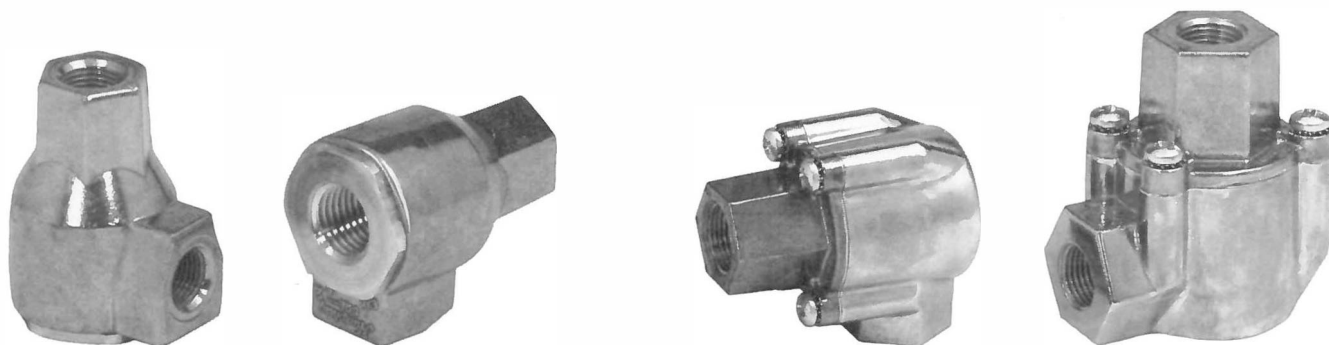

SQE1



SQE2



QE2



QE3



How Super Quick Exhaust Valves are used to enhance the performance of air cylinders

Lubrication Problem. Small bore cylinders are often poorly lubricated due to the small displacement of air per cycle. Lubricant back-flows through control valve on the exhaust cycle without reaching cylinder. Oil traces at the valve exhaust port does not prove proper cylinder lubrication.

Solution: Close nipple Super Quick Exhaust to cylinder. This stops back-flow and allows progressive oil flow to cylinder. Oil traces at the Super QE exhaust port prove cylinder lubrication.

"Air Spring" Return. Provides controlled "air spring" return, a potential advantage over standard spring return cylinders in that the "air spring" return force can be adjusted by a regulator. Also provides a method of controlling double acting cylinders with a 3-way valve. Return-regulator (1) set at selected pressure. (2) Normally closed 3-way valve. (3) Double acting cylinder. Example of use: Cylinder rod extends with high pressure. Rod retracts under low pressure.

Super Quick Exhaust used as a shuttle valve. Air from 3-way valves (1 or 2) always directed to cylinder (3).

High-Low Pressure. Reduce noise, shock, and stress on cylinder. Extend rod with low pressure (2) to position, hold, etc. Switch to high pressure (1) to lock, bend, reposition, etc. Return to low pressure by closing (1), or retract rod by closing (1) and (2).

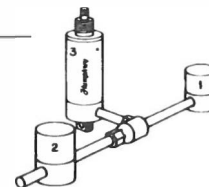
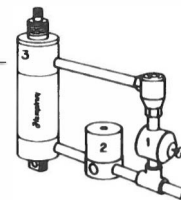
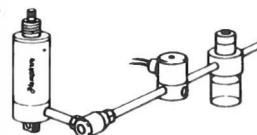

How It Works:

(Broken Lines - Shuttle Valve)
(Solid Lines - Quick Exhaust)

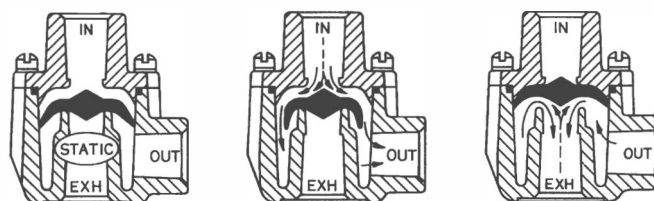

*Always exhausts out this port.
Add muffler to reduce noise. Plug for use as check valve.

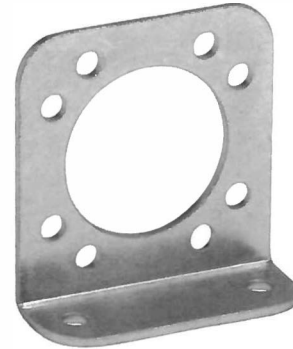
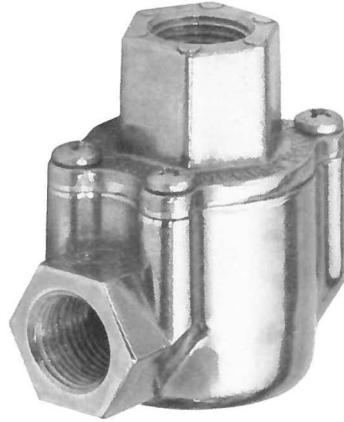

QE4



QE5



8-12 Mounting Bracket for QE4 and QE5

8-1A Mounting Bracket for QE2 and QE3

Specifications

MEDIA:
Compressed Air (Consult factor for others)
PRESSURE RANGE:
150 psig (10.7 bars) Maximum
TEMPERATURE RANGE:
-25 to 180°F (-31.7 to 82.2°C)

OPERATING SPEEDS:
To 600 CPM
MATERIALS:
Zinc & Aluminum Die Cast, Zinc Plated Steel
Fasteners, Buna N, Polyurethane
LUBRICATION Not required

MODEL	PORT SIZE			PSI/BARS		OPERATING SPEEDS			
	IN	OUT	EXHAUST	MIN	MAX	30 PSIG CFM	(2.1 BARS) LPM	50 PSIG CPM	(3.5 BARS) LPM
SQE1	1/4"	1/4"	1/4"	4/3	150/10.7	22.5	636.8	33.5	948.1
SQE2	1/4"	1/4"	1/4"	4/3	150/10.7	32.0	905.6	47.0	1330.1
QE2	1/4"	1/4"	3/8"	3/2	150/10.7	45.0	1273.5	65.0	1839.5
QE3	3/8"	3/8"	3/8"	2/14	150/10.7	55.0	1556.5	80.0	2264.0
QE4	1/2"	1/2"	3/8"	1/07	150/10.7	Consult Factory			
QE5	3/8"	3/8"	3/8"	1/07	150/10.7	Consult Factory			

Air Flow to Atmosphere

MODEL	AIR FLOW TO ATMOSPHERE						WEIGHT	
	80 PSIG CFM	(5.5 BARS) LPM	100 PSIG CFM	(7.0 BARS) LPM	125 PSIG CFM	(8.6 BARS) LPM	ACTUAL LBS	KGS
SQE1	51.0	1443.3	63.0	1782.9	75.0	2122.5	0.17	0.08
SQE2	70.0	1981.0	85.0	2405.5	104.0	2943.2	0.16	0.07
QE2	96.0	2716.8	120.0	3396.0	150.0	4245.0	0.31	0.14
QE3	125.0	3537.5	155.0	4386.5	190.0	5377.0	0.29	0.13
QE4	Consult Factory						0.99	0.45
QE5	Consult Factory						0.93	0.42

Fill/Exhaust Time (Seconds)

MODEL	PORT-NPT			A = 10 CU. IN. (164cc)	B = 100 CU. IN. (1640cc)	C = 1000 CU. IN. (16,400cc)
	IN	OUT	EXHAUST	FILL 0-80 PSIG (0-5.5 BARS) EXHAUST 100-20 PSIG (7.0-1.4 BARS)		
SQE1	1/4"	1/4"	1/4"	A	.036	.022
SQE2	1/4"	1/4"	1/4"	A	.027	.021
QE2	1/4"	1/4"	3/8"	B	.170	.160
QE3	3/8"	3/8"	3/8"	B	.130	.100
QE4	1/2"	1/2"	3/8"	C	.537	.440
QE5	3/8"	3/8"	3/8"	C	.508	.417

Dimensions

MODEL	A	B	C	D	E	F	G	H	J	K	L	
SQE1	1.09	.55	.81	1.22	1.67	BRACKET NOT AVAILABLE						INCHES
SQE2	27.7	13.9	20.5	30.9	42.4	BRACKET NOT AVAILABLE						MM
QE2	1.50	.83	1.25	1.78	2.38	1.14	1.50	2.19	.86	.55	.34	INCHES
QE3	38.1	21.1	31.8	45.2	60.4	28.9	38.1	55.6	21.8	13.9	.86	MM
QE4	2.18	1.14	1.81	2.78	3.66	1.48	2.00	2.75	1.33	.61	.27	INCHES
QE5	55.4	28.9	45.9	70.6	92.9	37.5	50.8	69.8	33.7	15.4	.68	MM

Steel brackets 8-1A (14 gauge) and 8-12 (12 gauge) are shipped loose. Mount to valve at 90° increment.

