

SACC-E-M12MS-8CON-M12 PSCUP

Order No.: 1436440

<http://eshop.phoenixcontact.de/phoenix/treeViewClick.do?UID=1436440>Sensor/actuator flush-type connector, socket, 8-pos., M12, A-coded,
front/screw mounting with M12 thread, with solder cups, plastic version

Commercial data	
GTIN (EAN)	 4 046356 438391
sales group	D125
Pack	20 pcs.
Customs tariff	85366990
Catalog page information	Page 36 (PC-2011)

Product notes

WEEE/RoHS-compliant since:
07/30/2008

<http://www.download.phoenixcontact.com>
Please note that the data given here has been taken from the online catalog. For comprehensive information and data, please refer to the user documentation. The General Terms and Conditions of Use apply to Internet downloads.

Technical data

General data

Rated current at 40°C	1.5 A
Rated voltage	30 V
Number of positions	17
Volume resistance	≤ 3 mΩ

Insulation resistance	≥ 100 MΩ
Ambient temperature (operation)	-25 °C ... 85 °C (Male connector / female connector)

General characteristics

Standards/regulations	M12 connector IEC 61076-2-101
Coding	A - standard
Surge voltage category	II
Pollution degree	3
Degree of protection	IP67
Contact material	CuZn
Contact surface material	Au
Contact carrier material	PA 66
Material, knurls	Zinc die-cast, nickel-plated
Sealing material	NBR
Mounting type	Rear mounting Pg9 With flat nut
Connection method	Solder pins
Length of the solder contacts	6 mm
Status display	No

Certificates / Approvals



Certification UL

Diagrams/Drawings

Drilling plan/solder pad geometry

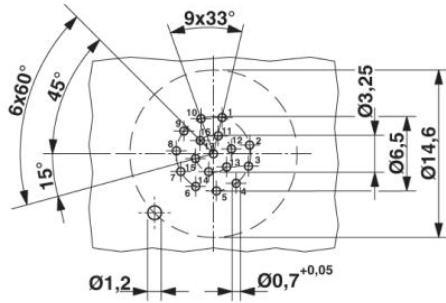

Dimensioned drawing

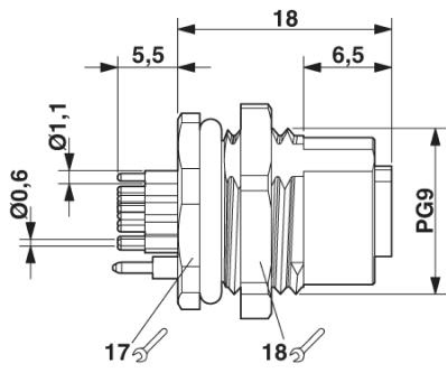

M12 flush-type connector

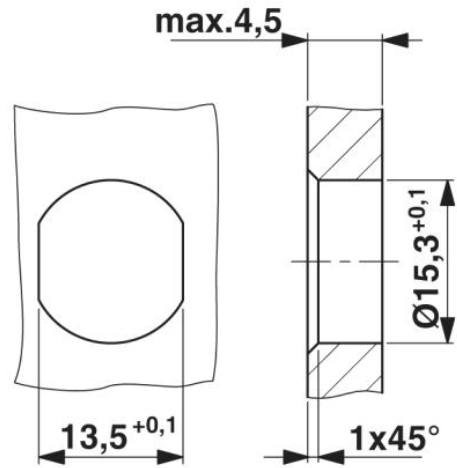

Mounting cutout with polarization for Pg9 thread

M12 front view

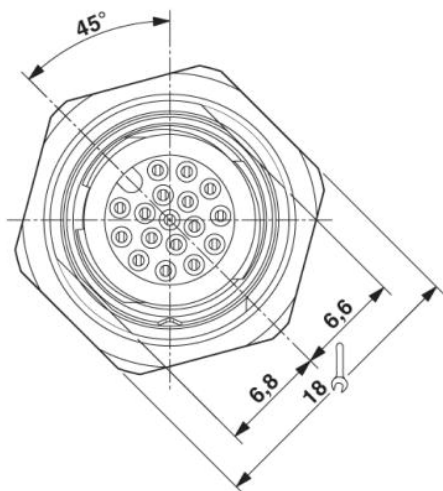

Schematic diagram

Pin assignment M12, 17-pos., female side view

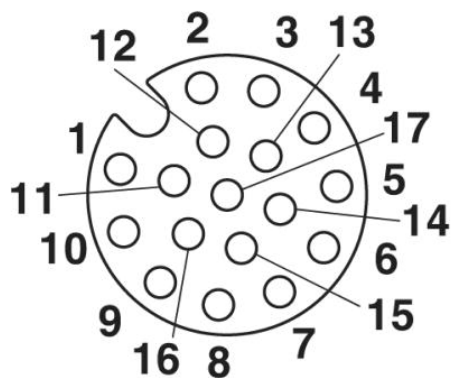

Address

PHOENIX CONTACT Deutschland GmbH
Flachmarktstr. 8
32825 Blomberg, Germany
Phone +49 5235 3 12000
Fax +49 5235 3 41200
<http://www.phoenixcontact.de>



© 2011 Phoenix Contact
Technical modifications reserved;