

SACC-E-M12MS-8CON-M12 PSCUP

Order No.: 1436440

<http://eshop.phoenixcontact.de/phoenix/treeViewClick.do?UID=1436440>Sensor/actuator flush-type connector, socket, 8-pos., M12, A-coded,
front/screw mounting with M12 thread, with solder cups, plastic version

Commercial data	
GTIN (EAN)	 4 046356 438391
sales group	D125
Pack	20 pcs.
Customs tariff	85366990
Catalog page information	Page 36 (PC-2011)

Product notes

WEEE/RoHS-compliant since:
07/30/2008

<http://www.download.phoenixcontact.com>
Please note that the data given here has been taken from the online catalog. For comprehensive information and data, please refer to the user documentation. The General Terms and Conditions of Use apply to Internet downloads.

Technical data

General data

Rated current at 40°C	4 A
Rated voltage	60 V
Number of positions	4
Volume resistance	≤ 3 mΩ

Insulation resistance	≥ 100 MΩ
Ambient temperature (operation)	-25 °C ... 85 °C (Male connector / female connector)

General characteristics

Coding	A - standard
Surge voltage category	II
Pollution degree	3
Degree of protection	IP67
Contact material	CuZn
Contact surface material	Au
Contact carrier material	PA 66
Material, knurls	Zinc die-cast, nickel-plated
Sealing material	NBR
Mounting type	Rear mounting M12 x 1 With flat nut
Connection method	Solder pins
Status display	No

Certificates / Approvals



Certification

UL

Diagrams/Drawings

Drilling plan/solder pad geometry

Drilling diagram

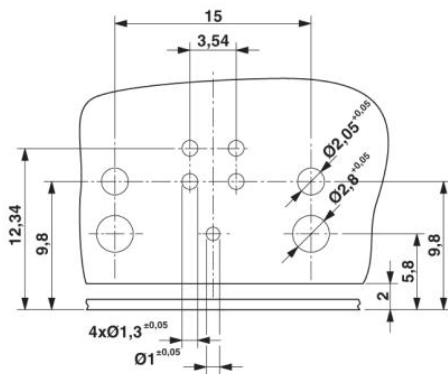

Dimensioned drawing

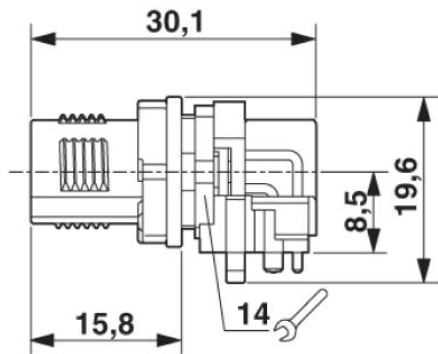

M12 flush-type connector, connector, side view

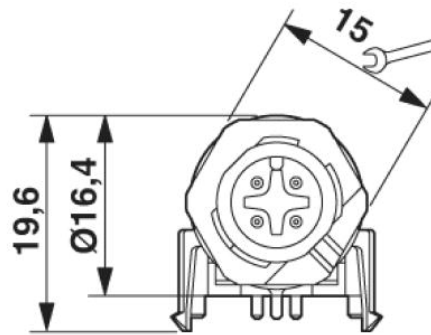

M12 flush-type connector, connector, front view

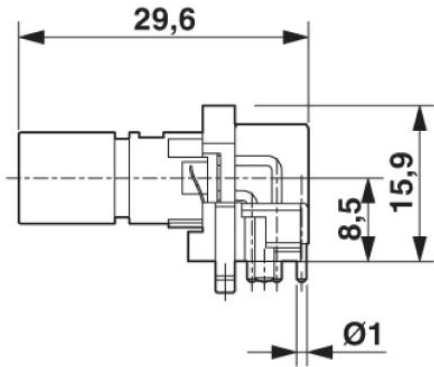

M12 flush-type connector, connector, contact carrier, side view

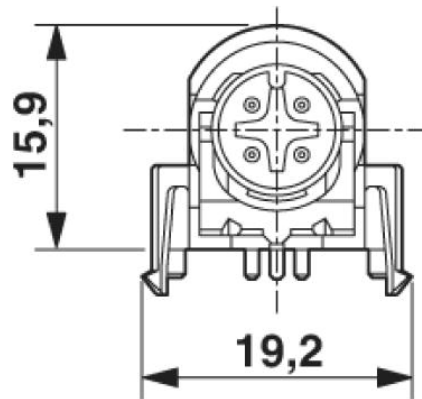

M12 flush-type connector, plug, contact carrier, front view

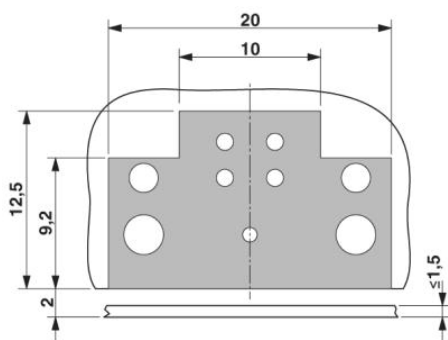

Locked area on the PCB

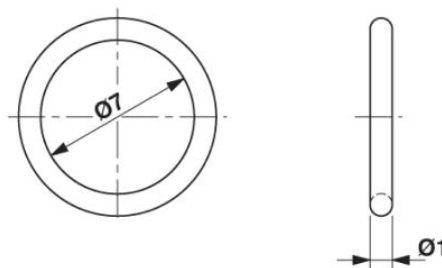

Optionally with O-ring (green) for tight seal when plugged in.
 - the axial mating force of 80 N per connector may not be exceeded when using with assembled O-ring!
 - Avoid radial forces!

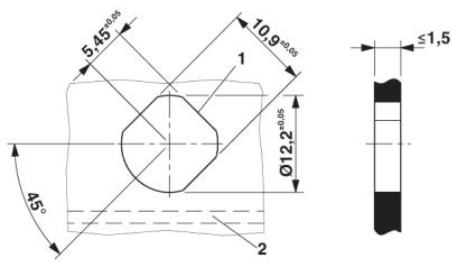

Panel cutout, view from front in case of horizontal PCB (2). The 3rd flat area is optional (1).

Schematic diagram

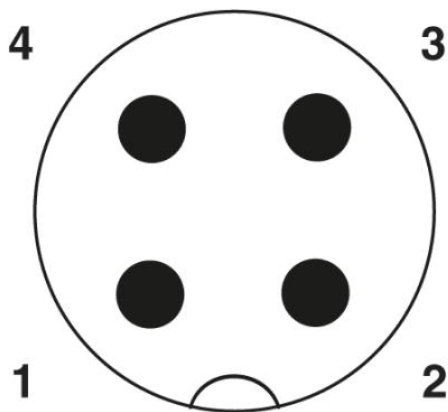

Pin assignment M12 plug, 4-pos., A-coded, view plug side

Address

PHOENIX CONTACT Deutschland GmbH
Flachmarktstr. 8
32825 Blomberg, Germany
Phone +49 5235 3 12000
Fax +49 5235 3 41200
<http://www.phoenixcontact.de>



© 2011 Phoenix Contact
Technical modifications reserved;