

SACC-DSIV-FSB-5CON-L180 SCO

Order No.: 1542606

<http://eshop.phoenixcontact.de/phoenix/treeViewClick.do?UID=1542606>

Sensor/actuator flush-type socket, 5-pos., M12 SPEEDCON, B-coded, rear/screw mounting with M12 thread, with polarity protection, with straight solder connection



Product notes

WEEE/RoHS-compliant since:
05/01/2006



Commercial data

GTIN (EAN)	 4 046356 097871
sales group	D125
Pack	10 pcs.
Customs tariff	85366990
Catalog page information	Page 30 (PC-2009)

<http://www.download.phoenixcontact.com>
Please note that the data given here has been taken from the online catalog. For comprehensive information and data, please refer to the user documentation. The General Terms and Conditions of Use apply to Internet downloads.

Technical data

General data

Rated current at 40°C	2 A
Rated voltage	30 V
Number of positions	8
Volume resistance	≤ 3 mΩ

Insulation resistance	≥ 100 MΩ
Ambient temperature (operation)	-25 °C ... 85 °C (female)

General characteristics

Coding	A - standard
Surge voltage category	II
Pollution degree	3
Degree of protection	IP67
Contact material	CuZn
Contact surface material	Au
Contact carrier material	PA 66
Material, knurls	Zinc die-cast, nickel-plated
Sealing material	FKM / EPDM
Mounting type	Rear mounting M12 x 1 With flat nut
Connection method	THR solder connection
Status display	No

Diagrams/Drawings

Drilling plan/solder pad geometry

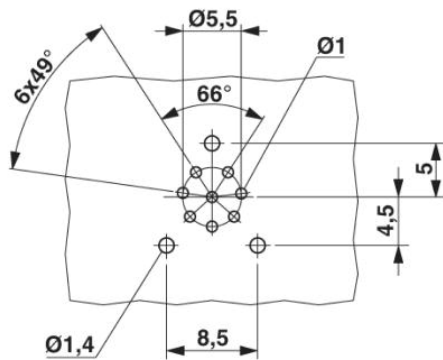

Dimensioned drawing

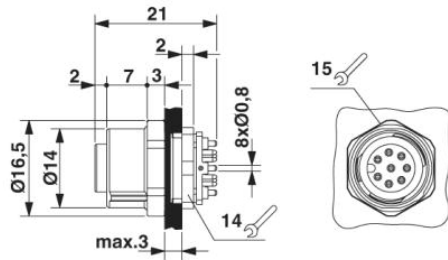

M12 flush-type connector

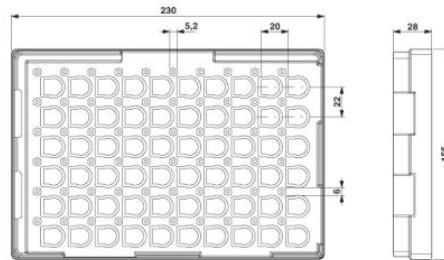

THR tray packaging

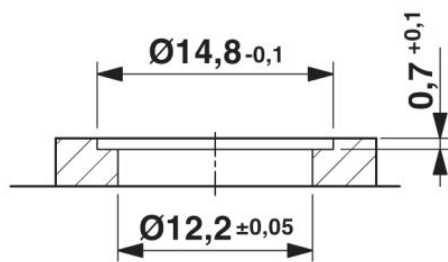

Housing cut-out for two-part M12 flush-type connectors with THR and wave soldering connection, version 1

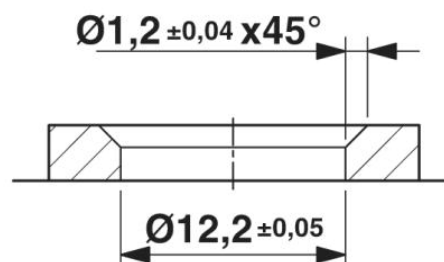

Housing cut-out for two-part M12 flush-type connectors with THR and wave soldering connection, version 2

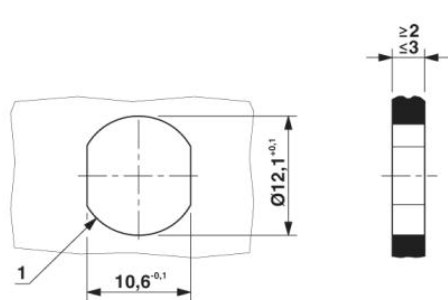

Housing cutout for M12 fastening thread, mounting panel with feed-through hole (alternative with surface as protection against rotation)

Schematic diagram

Pin assignment M12 socket, 8-pos., A-coded, view female side

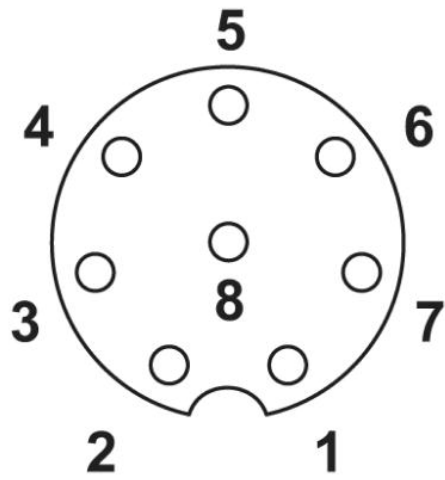

Address

PHOENIX CONTACT Deutschland GmbH
Flachmarktstr. 8
32825 Blomberg, Germany
Phone +49 5235 3 12000
Fax +49 5235 3 41200
<http://www.phoenixcontact.de>



© 2011 Phoenix Contact
Technical modifications reserved;