

Circular connectors M5 to M12

Product overview 2016/2017

Circular connectors for demanding applications

The PLUSCON circular M5-M12 product program from Phoenix Contact consists of standardized circular connectors that have been developed to the industry standard in industrial automation, from infrastructure and rail technology to outdoor applications.

The wide selection of designs enables comprehensive connection solutions for devices with data rates up to 10 Gbps, for connecting signals up to 17 pos. and for power supplies up to 630 V and 16 A in the smallest installation space.



Signals up to 17-pos.

- Currents up to 4 A
- Voltages up to 250 V
- Available with an optional shield connection

 Web code: #0680

Find out more with the web code

You can find our web code in any product table: a pound sign followed by a four-digit number combination (example: #1234).

This allows you to access information on our website quickly.

It couldn't be simpler:

1. Go to the Phoenix Contact website
2. Enter # and the number combination in the search field
3. Get more information and product versions

Or use the direct link:

phoenixcontact.net/webcode/#1234



Data up to 10 Gbps

- Codings for all commonly used fieldbus systems
- Hybrid connectors for simultaneous data and PoE transmission (Power over Ethernet)
- Components according to CAT6_A

 Web code: #0682



Power up to 16 A / 630 V

- Connection cross sections up to 2.5 mm²
- For 1-phase and 3-phase line voltage applications
- No risk of mismatching for AC and DC applications

 Web code: #0681

Contents

Unique variety for signals, data and power	4
Page navigation	12
Device connectors for front and rear mounting	
Signal	14
Data	31
Power	40
Connectors for assembly	
Signal	44
Data, power	47
Assembled cables	
Signal	48
Data	49
Accessories	
Pin assignments and litz wire colors	
	52

Unique variety for signals, data and power

The rapid enhancement of industrial electronics is constantly placing new demands on device connection technology.

Phoenix Contact is your innovative partner for practice-oriented integration of device connectors in almost all applications.

The modular structure of device connectors facilitates the simple and cost-effective integration of various data, signal, and power supply pin assignments into a device concept.



For high contact density

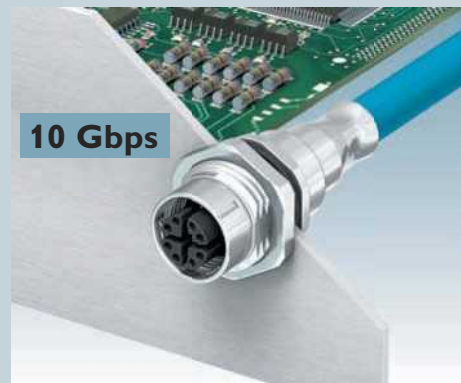

For fast data transmission



For high performance

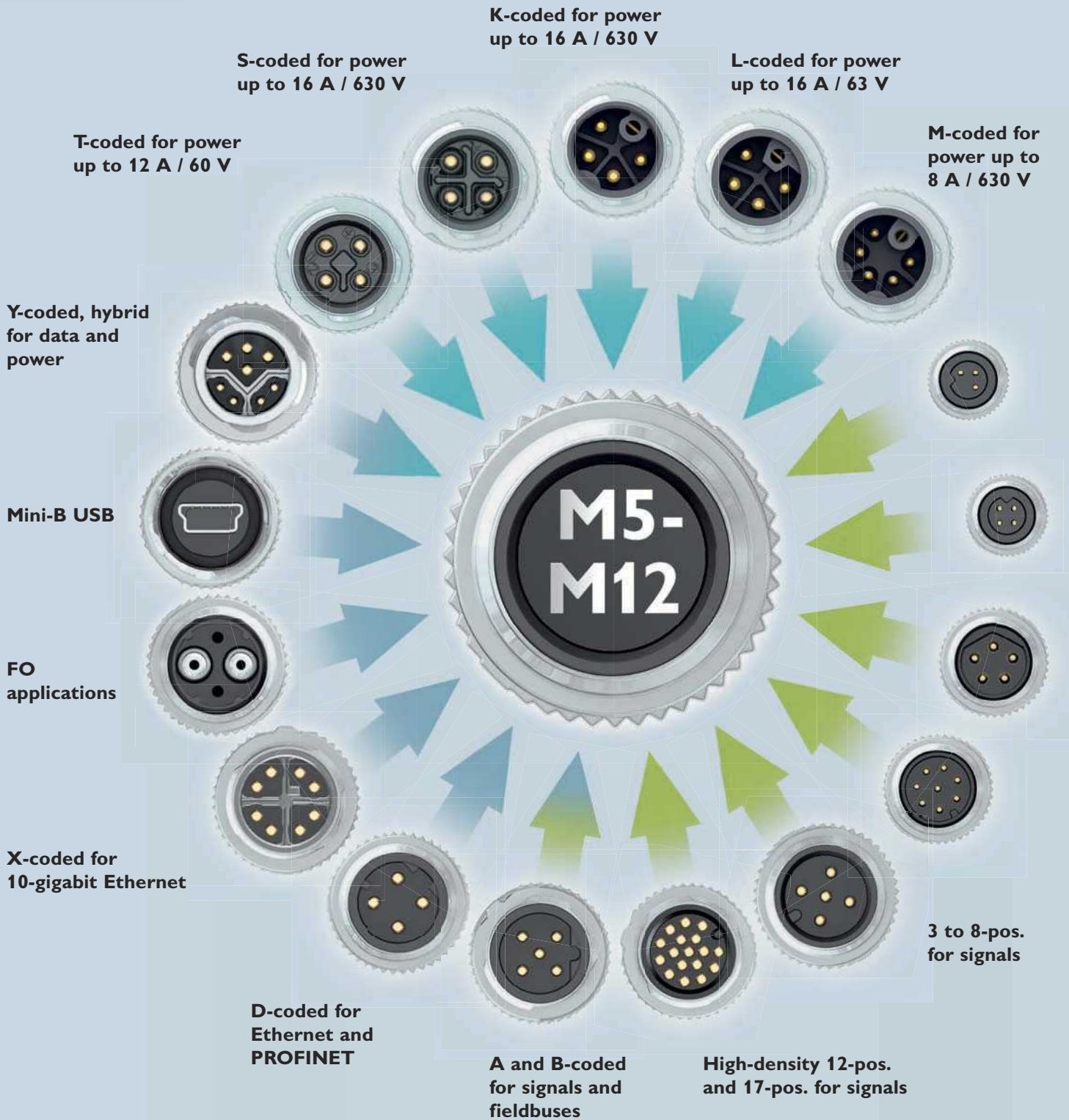

Device connectors with litz wires and cable connection

Pluggable device connectors with litz wires or size M5, M8, and M12 round cables are available as an alternative to a fixed cable connection. Thanks to its wide range of housing designs, Phoenix Contact can offer an appropriate solution for every individual application.



Variety of mounting options



Front mounting



Rear mounting



Modular mounting

Main features

- Pre-assembled with litz wires or cables
- Optional shield connection
- Various assembly methods with metric or Pg fastening threads



Device connection technology by Phoenix Contact for distributed modules is designed for harsh ambient conditions in industrial production processes.

Advantages at a glance



Pre-assembled cables

- No field assembly necessary
- Various cable lengths and assemblies



Easy positioning

- Defined cable outlet direction

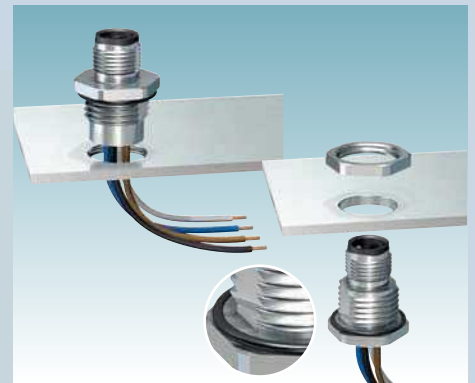

Safe mounting

- XL housing versions simplify the device cut-out
- Increased safety and tightness thanks to tightening limitation



Reliable seals

- When unplugged
- Device electronics protection



Reliable transmission

- 360° shield connection
- Fieldbus-specific cables



Fieldbus-specific coding

- No risk of mismatching, thanks to colored and mechanical, fieldbus-specific codings

Device connectors for PCB connection

Phoenix Contact offers a wide range of one-piece and two-piece device connectors for PCB assembly in M5, M8 and M12 types. This means that various connection solutions are available to you for wave, THR, and SMD soldering processes.

The two-piece device connectors facilitate the realization of all numbers of positions and codings for signal, data and power supply in identical mechanical installation conditions.



PCB connection



One-piece and two-piece, for wave soldering processes

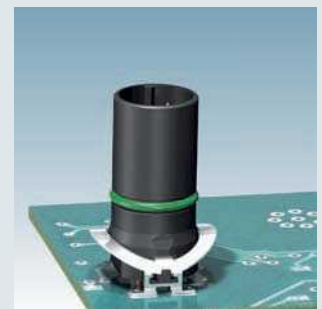

Two-piece, for SMD processes



Two-piece, for THR processes

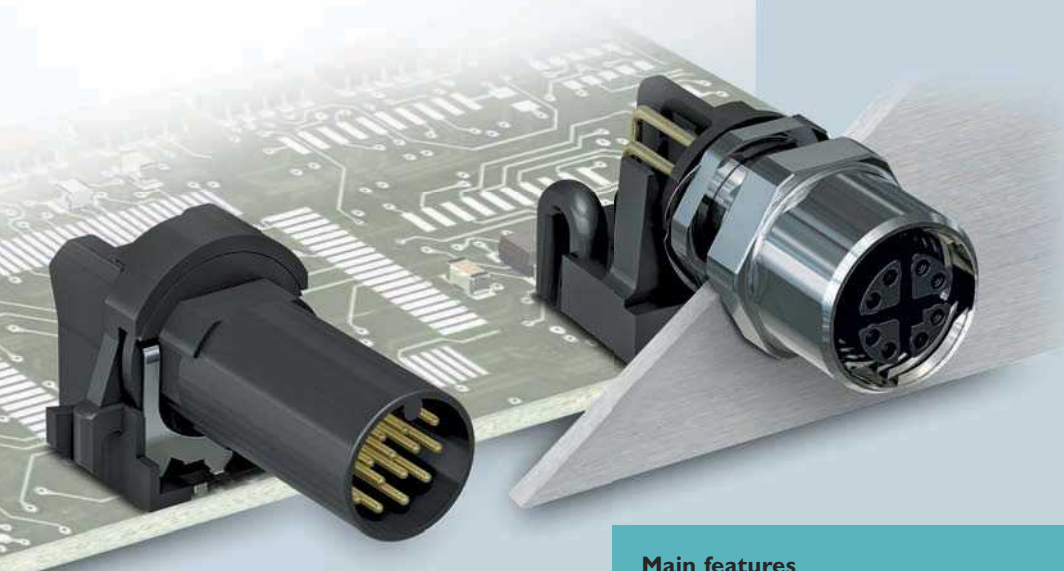

Main features

- One-piece connectors for the wave soldering process with 6 mm and 12 mm contact lengths
- Available with an optional shield connection
- Two-piece device connectors for wave, THR and SMD soldering processes in all available numbers of positions and codings
- Easy housing integration thanks to uniform Design-In design

Advantages at a glance

new

Unique tolerance compensation

- M12 VARIOPORT screw connection compensates for process-related production tolerances between the housing and PCB

A wide variety of device port solutions

- Use of housing screw connections with threaded fastening, press-in contour or for direct integration into the front panel

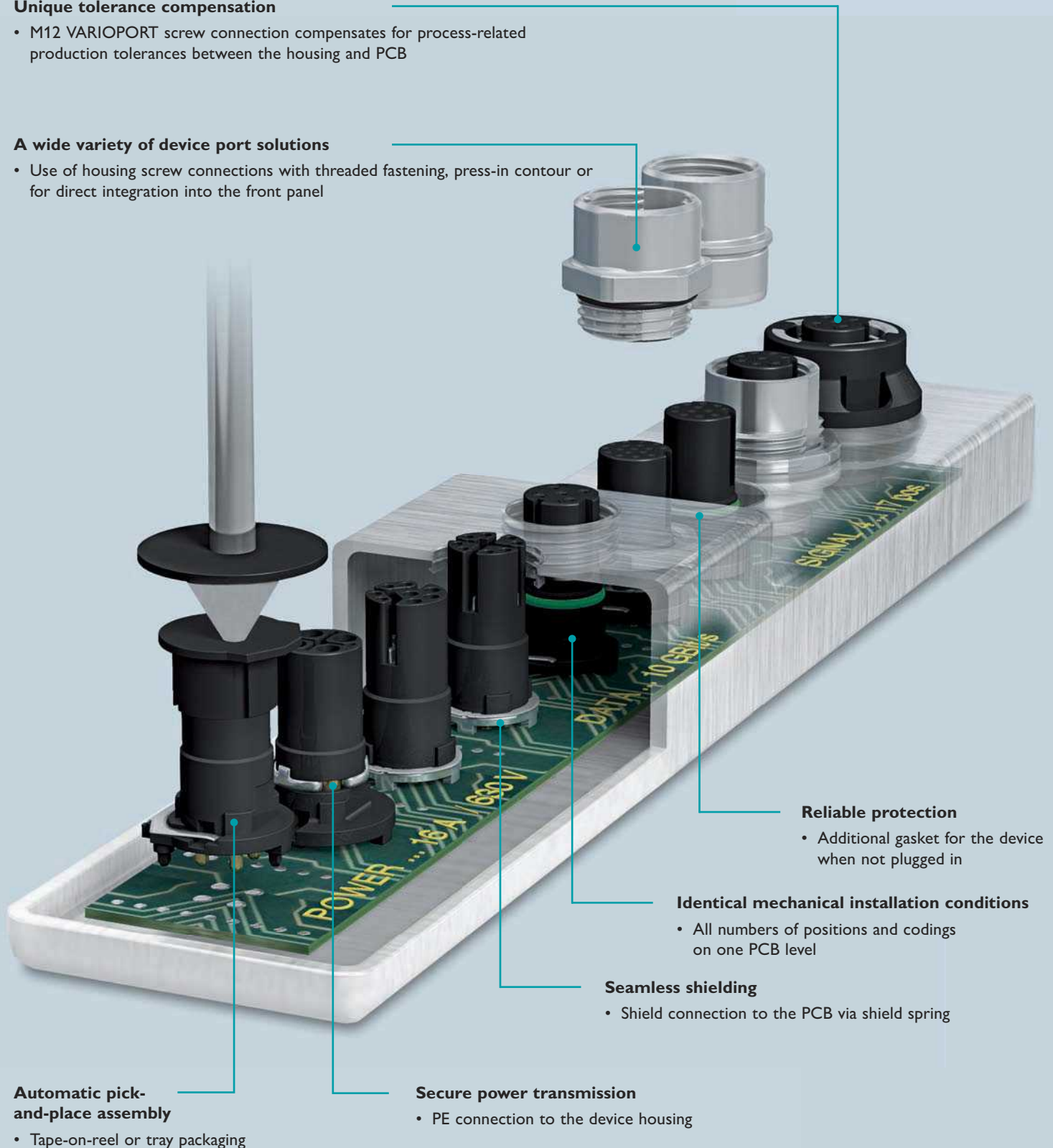

Connectors and cables for field cabling

Connect your devices quickly and safely in the field. You can wire different cable types and lengths on-site with connectors for assembly.

You have access to a comprehensive product range of assembled cables for quick and convenient field cabling. Halogen-free PUR cabling, which we use as standard, already meets the requirements of many fields of application.



Wide variety of cabling



For fieldbuses and networks



For signals,
3 to 17-pos.



For power,
up to 16 A / 630 V

Main features

Short connect time, thanks to SPEEDCON fast locking system

- The right cable and right connector for every application
- Flexible cabling arrangement thanks to connectors for assembly in socket and connector versions



Special shielding concepts and torsion-resistant cables are essential for the reliable operation of systems and robots.

Advantages at a glance



Fast locking

- Reduced connection times with optional SPEEDCON fast locking system



Application-specific solutions

- Customer-specific assemblies and cable lengths



Screw connection

- Well-known connection technology for all cable and insulation types



IDC displacement connection QUICKON

- Fastest connection on the market, gas-tight contact and vibration-resistant

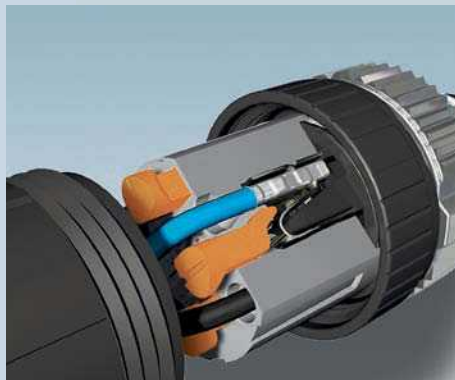

Spring connection

- Easy, secure wiring for all cable and insulation types with and without ferrules

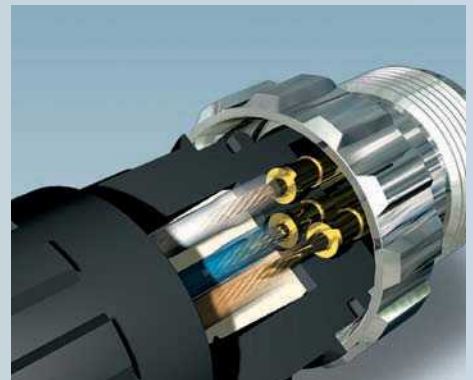









Pierce connection

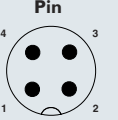
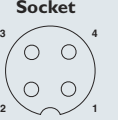
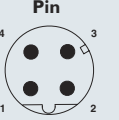
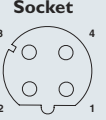



- Reliable connection to the smallest installation space



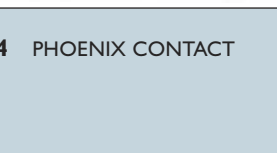

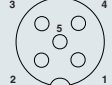
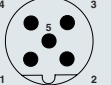
Page navigation – Circular connectors in M5, M8 and M12

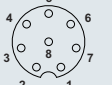
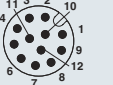

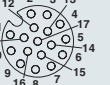

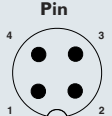
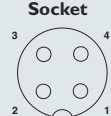
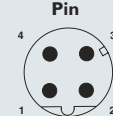
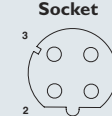
Design	Number of positions	3	4		5	
	Coding	A	A	D	A	B
M12 device connector for litz wire connection						
	Front mounting with litz wires	–	14 / 37	14	14	14
	Rear mounting with litz wires	–	16	16	16	16
	Front mounting, modular, crimp connection	–	16	16	16	16
	Front mounting, with solder cups	–	–	–	18	–
	Rear mounting, with solder cups	–	–	–	20	–
M12 device connector with assembled cable						
	Front mounting	–	–	31	36	34
	Rear mounting	–	18 / 37	31 / 33	18 / 36	34
M12 device connector for PCB connection						
	One-piece, front mounting	–	18	18	18	18
	One-piece, rear mounting	–	20 / 37	20 / 31 33	20 / 36	34
	Two-piece, for wave/THR soldering processes	–	22	22	22	22
	Two-piece, for SMD soldering processes	–	24	24	24	24
M12 connector, for assembly / with molded cable						
	Plastic-molded cables	48	48	49	48	48
	Can be assembled	–	44	47	44 / 47	47
M8 device connector with litz wires						
	Front mounting	26	26	–	–	39
	Rear mounting	26	26	–	–	–
M8 device connector for PCB connection						
	One-piece, rear mounting	26	26	–	–	39
	Two-piece, for SMD soldering processes	28	28	–	–	39
M8 connector, for assembly / with molded cable						
	Plastic-molded cables	48	48	–	–	–
	Can be assembled	46	46	–	–	–
M5 device connector with litz wires						
	Front mounting	30	30	–	–	–
M5 device connector for PCB connection						
	One-piece, rear mounting	30	30	–	–	–



6	8			12	17	2+PE	3+PE	4	4+PE	4+PE	5+PE
A	A	X	Y	A	A	S	S	T	K	L	M
-	14	-	-	14	14	40	40	40	40	40	40
-	16	-	32	16	16	40	40	40	40	40	40
-	16	-	-	-	-	-	40	40	-	-	-
-	18	-	-	-	-	-	-	-	-	-	-
-	20	-	-	-	-	-	-	-	-	-	-
-	-	-	-	-	-	-	-	-	-	-	-
-	18 / 31 33	32	32	18	18	-	-	-	-	-	-
-	18	-	-	-	-	-	-	-	-	-	-
-	20	32	32	20	20	-	-	-	-	43	-
-	22	32	32	22	22	-	42	42	43	43	43
-	24	32	32	24	24	-	-	42	-	-	-
-	49	49	-	-	-	-	-	-	-	-	-
-	44 / 47	47	-	-	45	-	47	47	-	-	-
26	26	-	-	-	-	-	-	-	-	-	-
26	26	-	-	-	-	-	-	-	-	-	-
26	26	-	-	-	-	-	-	-	-	-	-
28	28	-	-	-	-	-	-	-	-	-	-
-	-	-	-	-	-	-	-	-	-	-	-
-	-	-	-	-	-	-	-	-	-	-	-
-	-	-	-	-	-	-	-	-	-	-	-
-	-	-	-	-	-	-	-	-	-	-	-

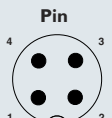
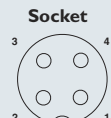
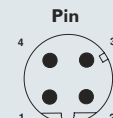
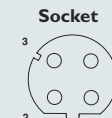

Signal – M12, with litz wires, front mounting		4-pos.			
Pre-assembled with 0.5 m long litz wires	Coding	A		D	
	Rated voltage	250 V		250 V	
	Nominal current	4 A		4 A	
	Conductor cross section	0.34 mm ²		0.34 mm ²	
 Web code: #0207	Pin assignment				
Versions with cast zinc housing for screw fastening					
	Pg9	1693762	1693788	–	–
	Pg9 flat nut				
	M16 x 1.5	1523450	1523434	1551558	1535202
	M16 x 1.5 flat nut				
	M16 x 1.5, XL versions, wrench size 19	1411577	1411568	1411578	1411569
	M16 x 1.5 flat nut				
	Pg9, can be positioned	1693775	1693791	–	–
	M16 x 1.5, can be positioned	1523463	1523447	1552256	1535215
	20 mm square flange, mounting holes 4 x Ø 3.2 mm	1419784	1419797	1441626	1441639
	25 mm square flange, mounting holes 4 x Ø 2.7 mm	1419991	1420003	1440957	1440960
Versions with plastic and brass (nickel-plated) housing for screw fastening					
	Plastic M16 x 1.5	–	–	–	–
	Brass (nickel-plated) M20 x 1.5	1408451	1408436	–	–
Versions with stainless steel housing (1.4404) for screw fastening					
	Pg9	1554555	1555448	–	–
	Pg9 flat nut				
	M16 x 1.5	1405233	1458855	–	–
	M16 x 1.5 flat nut				
	Pg9, can be positioned	1554610	1554649	–	–
	M20 x 1.5	1408415	1408416	–	–

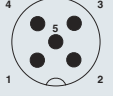
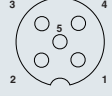
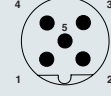
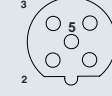
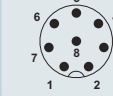
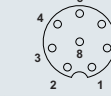

5-pos.				8-pos.		12-pos.		17-pos.	
A		B		A		A		A	
60 V		60 V		30 V		30 V		30 V	
4 A		4 A		2 A		1.5 A		1.5 A	
0.34 mm ²		0.34 mm ²		0.25 mm ²		0.14 mm ²		0.14 mm ²	
Pin	Socket	Pin	Socket	Pin	Socket	Pin	Socket	Pin	Socket
									
1671111	1671098	–	–	1513774	1513758	–	–	–	–
1504084									
1520055	1520039	1520013	1520000	1523492	1523476	1556265	1556252	1556304	1556294
1504097									
1411579	1411571	1411580	1411572	1411581	1411573	1411582	1411574	1411583	1411576
1504097									
1671124	1671108	1515057	1515044	1513787	1513761	–	–	–	–
1520068	1520042	1520026	1519998	1523502	1523489	–	–	–	–
1441642	1441655	1441668	1441671	1441684	1441697	1441707	1441710	1441723	1441736
1440973	1440986	1440999	1441558	1441561	1441574	1441587	1441590	1441600	1441613
1436411	–	–	–	1436424	–	–	–	–	–
1408446	1408454	–	–	1408442	1408453	–	–	–	–
1554568	1699863	–	1452343	1554571	1554607	–	–	–	–
1404984									
1458868	1458871	–	–	1405221	1458842	1405238	1405242	1405243	1405244
1404983									
1554623	1554652	–	1424023	1554636	1554665	–	–	–	–
1452068	1452071	1452084	1452097	1452107	1452110	–	–	–	–

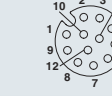
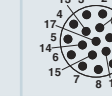
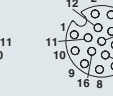
Signal – M12, crimp connection, front mounting		4-pos.			
Modular	Coding	A		D	
	Rated voltage	250 V		250 V	
	Nominal current	4 A		4 A	
	Conductor cross section	0.34 mm ²		0.34 mm ²	
 Web code: #0208	Pin assignment				
	25 mm square flange, mounting holes 4 x Ø 3.2 mm				
	Pre-assembled contact carrier, with 0.5 m long litz wires	1440805	–	1440821	–
	Contact carrier for crimp contacts, can be assembled	1440931	–	1440944	–
	Crimp contacts Ø 1.0 mm, 0.08 ... 0.34 mm ²	1452356	–	1452356	–
	Crimp contacts Ø 0.8 mm, 0.08 ... 0.34 mm ²	–	–	–	–
	Crimping tool				

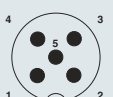
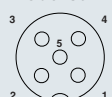
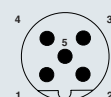
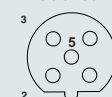
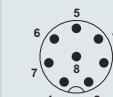
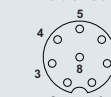
Signal – M12, with litz wires, rear mounting		4-pos.			
Pre-assembled with 0.5 m long litz wires	Coding	A		D	
	Rated voltage	250 V		250 V	
	Nominal current	4 A		4 A	
	Conductor cross section	0.34 mm ²		0.34 mm ²	
 Web code: #0209	Pin assignment				
Versions with cast zinc housing for screw fastening					
	Pg9	1556618	1556621	1551532	1551529
	M12 x 1	1551875	–	1551901	–
	M16 x 1.5	1419629	1419632	1419603	1419616
	M16 x 1.5, XL versions, wrench size 19	1411591	1411584	1411592	1411585
Versions with plastic housing for screw fastening					
	Pg9	–	–	–	–
Versions with stainless steel housing (1.4404) for screw fastening					
	Pg9	1405239	1405240	–	–

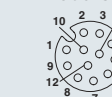
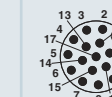
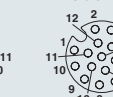
5-pos.		8-pos.		12-pos.		17-pos.			
A	B	A	A	A	A	A	A		
60 V	60 V	30 V	30 V	30 V	30 V	30 V	30 V		
4 A	4 A	2 A	2 A	1.5 A	1.5 A	1.5 A	1.5 A		
0.34 mm ²	0.34 mm ²	0.25 mm ²	0.25 mm ²	0.14 mm ²	0.14 mm ²	0.14 mm ²	0.14 mm ²		
Pin 	Socket 	Pin 	Socket 	Pin 	Socket 	Pin 	Socket 	Pin 	Socket 
1419959									
1440818	–	1440759	–	1457827	–	–	–	–	–
1419988	–	1440915	–	1440928	–	–	–	–	–
1452356	–	1452356	–	–	–	–	–	–	–
–	–	–	–	1452372	–	–	–	–	–
1212510									

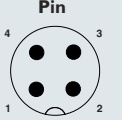
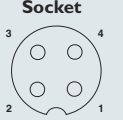
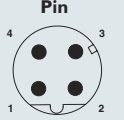
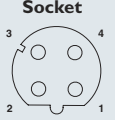





5-pos.		8-pos.		12-pos.		17-pos.			
A	B	A	A	A	A	A	A		
60 V	60 V	30 V	30 V	30 V	30 V	30 V	30 V		
4 A	4 A	2 A	2 A	1.5 A	1.5 A	1.5 A	1.5 A		
0.34 mm ²	0.34 mm ²	0.25 mm ²	0.25 mm ²	0.14 mm ²	0.14 mm ²	0.14 mm ²	0.14 mm ²		
Pin 	Socket 	Pin 	Socket 	Pin 	Socket 	Pin 	Socket 	Pin 	Socket 
1542703	1542729	1543663	1543676	1542716	1542732	1430459	1430446	1430475	1430462
1551888	–	1551891	–	1551914	–	1437122	–	1437135	–
1419645	1419658	1419661	1419674	1419687	1419690	1419700	1419713	1419726	1419739
1411593	1411586	1411594	1411587	1411595	1411588	1411596	1411589	1411597	1411590
–	1436356	–	–	–	1436369	–	–	–	–
1554681	1554717	–	–	1554694	1554720	–	–	–	–

Signal – M12, with cable, rear mounting		4-pos.			
Assembled cable/control cabinet feed-through	Coding	A		D	
	Rated voltage	250 V		250 V	
	Nominal current	4 A		4 A	
 Web code: #0210	Pin assignment				
Versions for screw fastening, shielded					
	M16 x 1.5 cable length 1 m, PUR black	1419399	1419302	–	–
	M16 x 1.5 cable length 2 m, PUR black	1419386	1419315	–	–
Control cabinet feed-throughs for screw fastening					
	M16 x 1.5 pin to socket	–	–	–	–
	M16 x 1.5 socket to socket	–	–	–	1424326

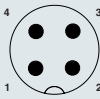
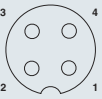
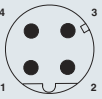
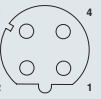
Signal – M12, solder connection, front mounting		4-pos.			
For soldering processes	Coding	A		D	
	Rated voltage	250 V		250 V	
	Nominal current	4 A		4 A	
 Web code: #0212	Pin assignment				
Versions for PCB mounting featuring torsion protection, for wave soldering processes					
	20 mm square flange, direct PCB mounting	1456417	1456420	1456394	1456404
	Plastic versions, with solder cups, straight, for screw fastening				
	M12 x 1	–	–	–	–
		M16 x 1.5	–	–	–



5-pos.				8-pos.		12-pos.		17-pos.	
A		B		A		A		A	
60 V		60 V		30 V		30 V		30 V	
4 A		4 A		2 A		1.5 A		1.5 A	
Pin	Socket	Pin	Socket	Pin	Socket	Pin	Socket	Pin	Socket
1419409	1419328	–	–	1419425	1419357	1442227	1442188	1442308	1442269
1419412	1419331	–	–	1419438	1419344	1442230	1442191	1442311	1442272
1551671	–	1551684	–	1551697	–	–	–	–	–
–	–	–	–	–	–	–	–	–	–

5-pos.				8-pos.		12-pos.		17-pos.	
A		B		A		A		A	
60 V		60 V		30 V		30 V		30 V	
4 A		4 A		2 A		1.5 A		1.5 A	
Pin	Socket	Pin	Socket	Pin	Socket	Pin	Socket	Pin	Socket
1456433	1456446	1456459	1456462	1408574	1408573	–	–	–	–
1436437	–	–	–	1436440	–	–	–	–	–
1436398	–	–	–	1436408	–	–	–	–	–

Signal – M12, solder connection, rear mounting		4-pos.				
For wave soldering processes	Coding	A		D		
	Rated voltage	250 V		250 V		
	Nominal current	4 A		4 A		
 Web code: #0213	Pin assignment					
Versions with cast zinc housing, one-piece, straight, for screw fastening						
	Pg9	6 mm solder pins	1553459	1553462	1551516	1551503
		12 mm solder pins	–	–	1552308	1552272
	M12 x 1	6 mm solder pins	1551820	–	1551859	–
	M16 x 1.5	6 mm solder pins	1419742	1419755	1441749	1441752
	Pg9, with shield contact	6 mm solder pins	1556841	–	1553035	1553006
		12 mm solder pins	1558535	1558522	1558519	1558506
	M12 x 1, with shield contact	6 mm solder pins	1552955	–	1552984	–
	M16 x 1.5, with shield contact	6 mm solder pins	1419768	1419771	1441862	1441875
Versions with plastic housing, one-piece, straight for screw fastening						
	Pg9		–	–	–	–
	Pg9 with solder cups	Max. 0.34 mm ²	–	–	–	–
		Max. 0.25 mm ²	–	–	–	–
Versions with stainless steel housing (1.4404), one-piece, straight for screw fastening						
	Pg9		1404979	1404974	–	–
Versions with brass housing (nickel-plated), two-piece including housing, straight*						
	Straight, shielded, for fastening in the feed-through hole		–	–	–	1534627
	Straight, for fastening in the feed-through hole		–	–	–	–

* Cannot be combined with two-piece contact carriers for PCB mounting for THR, SMD and wave soldering processes

5-pos.				8-pos.		12-pos.		17-pos.	
A		B		A		A		A	
60 V		60 V		30 V		30 V		30 V	
4 A		4 A		2 A		1.5 A		1.5 A	
1542745	1542761	1543647	1543650	1542758	1542774	1559932	1559929	1559961	1559958
1552311	1552285	1552324	1552298	-	1408770	-	-	-	-
1551833	-	1551846	-	1551862	-	1559945	-	1559974	-
1441765	1441778	1441781	1441794	1441804	1441817	1441820	1441833	1441846	1441859
1553048	1553019	1553051	1553022	1553873	1553860	1436783	1436770	1436819	1436806
1558551	1558548	1558577	1558564	-	1408771	-	-	-	-
1552968	-	1552971	-	1552997	-	1437106	-	1437119	-
1441888	1441891	1441901	1441914	1441927	1441930	1441943	1441956	1441969	1441972
-	1436330	-	-	-	1436343	-	-	-	-
-	1436314	-	-	-	-	-	-	-	-
-	-	-	-	-	1436327	-	-	-	-
1554746	1554733	-	-	1529807	1529797	-	-	-	-
1437193	1421685	1437203	1437180	-	-	-	-	-	-
1694211	1694237	1514883	1515934	-	1556854	-	-	-	-

Signal – M12, solder connection, PCB mounting		4-pos.			
For reflow and wave soldering processes	Coding	A		D	
	Rated voltage	250 V		250 V	
	Nominal current	4 A		4 A	
 Web code: #0214	Pin assignment	Pin	Socket	Pin	Socket
					
Two-piece, THR contact carrier					
	Straight, shielded, THR, in tray	1439939	1439955	1552214	1551451
	Straight, shielded, THR, on reel	1457500*	1457623*	1457513*	1457636*
	Straight, THR, in tray	1437164	1439942	–	–
	Straight, THR, on reel	1457490*	1457610*	–	–
Two-piece, wave soldering contact carrier					
	Angled, shielded, wave soldering, in blister pack	1439887	1432444	1436673	1432457
	Angled, wave soldering, in blister pack	1436660	1436628	–	–
	Straight, shielded, wave soldering, in blister pack	–	–	–	1551480
	Straight, wave soldering, in blister pack	–	–	–	–
Two-piece, housing screw connections for THR and wave soldering contact carriers					
	SPEEDCON screw versions with O-ring, front mounting, M12 x 1 screw fastening				
	Screw versions with O-ring, front mounting, M12 x 1 screw fastening				
	SPEEDCON screw versions with flat gasket, front mounting, M12 x 1 screw fastening				
	Screw versions with O-ring, rear mounting, M15 x 1 screw fastening				
	SPEEDCON screw versions with O-ring, rear mounting, M15 x 1 screw fastening				
	Clip-in versions, for straight, two-piece socket contact carriers, tolerance-compensating, rear snap-in mounting		For housing panel thickness 1.0 ... 1.8 mm		
			For housing panel thickness 1.7 ... 2.5 mm		
			For housing panel thickness 2.4 ... 3.2 mm		
			For housing panel thickness 3.1 ... 3.9 mm		
	Threaded sleeve				
	Fixing sleeve, can be used universally with any threaded sleeve			Color	
	Press-in versions, front mounting				

^{1), 2), 3)} Distance from PCB upper edge to housing front panel rear edge: ¹⁾ 6 mm / ²⁾ 7 mm / ³⁾ 9 mm

5-pos.				8-pos.		12-pos.		17-pos.	
A		B		A		A		A	
60 V		60 V		30 V		30 V		30 V	
4 A		4 A		2 A		1.5 A		1.5 A	
1432350	1432363	1552230	1551435	1557581	1551422	1442065*	1442052*	1442081*	1442078*
1457539*	1457652*	1457542*	1457665*	1457568*	1457681*	1457584*	1457704*	1457607*	1457720*
1552227	1551448	–	–	1552269	1557808	1441985*	1441970*	1442007*	1441998*
1457526*	1457649*	–	–	1457555*	1457678*	1457571*	1457694*	1457597*	1457717*
1439890	1432431	1436699	1432512	1437038	1437009	1424198	1424199	1424200	1424201
1436686	1436644	–	–	1436987	1436990	1424194	1424195	1424196	1424197
–	–	–	1551477	–	–	–	–	–	–
–	1551464	–	–	–	–	–	–	–	–
Pin: 1551493 / Socket: 1552243									
Pin: 1416145²⁾ / 1417984³⁾ / Socket: 1416144²⁾ / 1417989³⁾									
Pin: 1436709 / Socket: 1432460									
Pin: 1413997¹⁾ / 1413996²⁾ / Socket: 1414004¹⁾ / 1414003²⁾									
Pin: 1413999¹⁾ / 1413998²⁾ / Socket: 1414020¹⁾ / 1414005²⁾									
Socket: 1419630									
Socket: 1419631									
Socket: 1419633									
Socket: 1419634									
Black	Blue	Water blue	Red	Yellow	Green	Violet	Orange		
1419697	1417782	1417783	1417784	1417785	1417787	1417788	1417789		
Pin: 1437892 / Socket: 1437889									

* Contact carrier with assembly pad













Signal – M12, solder connection, PCB mounting		4-pos.			
For reflow soldering processes	Coding	A		D	
	Rated voltage	250 V		250 V	
	Nominal current	4 A		4 A	
 Web code: #0215	Pin assignment				
Two-piece, SMD contact carrier					
	Straight, SMD, in tray	1411924*	1411907	1411925*	1411912
	Straight, SMD, on reel	1411982*	1411974	1411983*	1411975
	Straight, shielded, SMD, in tray, additional gasket for the device when not plugged in	1411955*	1411949	1411956*	1411950
	Straight, shielded, SMD, on reel, additional gasket for the device when not plugged in	1412010*	1412004	1412011*	1412005
	Straight, SMD, in tray, additional gasket for the device when not plugged in	1411941*	1411935	1411942*	1411936
	Straight, SMD, on reel, additional gasket for the device when not plugged in	1411996*	1411990	1411997*	1411991
Two-piece, housing screw connections for SMD contact carriers					
	Screw versions, rear mounting, M15 x 1 screw fastening				
	SPEEDCON screw versions, rear mounting, M15 x 1 screw fastening				
new 	Clip-in versions, tolerance-compensating, rear snap-in mounting, threaded sleeve	For housing panel thickness 0.9 ... 1.6 mm			
		For housing panel thickness 1.6 ... 2.3 mm			
		For housing panel thickness 2.3 ... 3.0 mm			
	Fixing sleeve, can be used universally with any threaded sleeve	Color			
	Screw versions, front mounting, M14 x 1 screw fastening				
	M14 x 1 flat nut				
	Press-in versions, front mounting				

¹⁾ Without additional gasket for the device when not plugged in

5-pos.		8-pos.		12-pos.		17-pos.			
A	B	A	A	A	A	A	A		
60 V	60 V	30 V	30 V	30 V	30 V	30 V	30 V		
4 A	4 A	2 A	2 A	1.5 A	1.5 A	1.5 A	1.5 A		
1411926*	1411913	1411927*	1411914	1411928*	1411915	1411929*	1411916	1411930*	1411917
1411984*	1411976	1411985*	1411977	1411986*	1411978	1411987*	1411979	1411988*	1411980
1411957*	1411951	1411958*	1411952	1411959*	1411953	1411960*	1411954	1411961*	1411966 ¹⁾
1412012*	1412006	1412013*	1412007	1412014*	1412008	1412015*	1412009	1412016*	1412018 ¹⁾
1411943*	1411937	1411944*	1411938	1411945*	1411939	1411946*	1411940	1411947*	—
1411998*	1411992	1411999*	1411993	1412000*	1411994	1412001*	1411995	1412002*	—
Pin: 1414000 / Socket: 1414021									
Pin: 1414002 / Socket: 1414023									
Socket: 1419569									
Socket: 1419570									
Socket: 1419571									
Black	Water blue	Green	Violet						
1419568	1419565	1419566	1419567						
Pin: 1412078 / Socket: 1412079									
1412077									
Pin: 1412080 / Socket: 1412081									







* Contact carrier with assembly pad







Signal – M8, with litz wires		3-pos.	
Pre-assembled with 0.5 m long litz wires	Coding	A	
	Rated voltage	50 V AC / 60 V DC	
	Nominal current	4 A	
	Conductor cross section	0.25 mm ²	
 Web code: #0216	Pin assignment		
Front mounting			
	M8 x 0.5 fastening thread	1500334	1500350
	M8 flat nut		
	M10 fastening thread	–	–
Rear mounting			
	M8 x 1 fastening thread	1453478	–
	M10 fastening thread	–	1456080
	M12 fastening thread	–	1453449
Signal – M8, solder connection		3-pos.	
For wave soldering processes	Coding	A	
	Rated voltage	50 V AC / 60 V DC	
	Nominal current	4 A	
 Web code: #0218	Pin assignment		
Rear mounting, one-piece			
	M8 fastening thread, straight	1694334	–
	M12 fastening thread, straight	–	1694363
	M8 fastening thread, straight, shielded	1455997	–
	M8 fastening thread, angled, shielded	1456035	–
	M10 fastening thread, straight, shielded	–	1456116
	M10 fastening thread, angled, shielded	–	1456145
Rear mounting, two-piece			
	M8 fastening thread, straight	–	1524776
	M8 fastening thread, angled	1440070	1524788

4-pos.		6-pos.		8-pos.	
A		A		A	
50 V AC / 60 V DC		30 V AC / 30 V DC		30 V AC / 30 V DC	
4 A		2 A		1.5 A	
0.25 mm ²		0.14 mm ²		0.14 mm ²	
Pin	Socket	Pin	Socket	Pin	Socket
					
1500347	1500363	1542664	1542677	-	-
1504071					
-	-	-	-	1424232	1424231
1453481	-	1453494	-	1424230	-
-	1456093	-	1456103	-	-
-	1453452	-	1453465	-	-
4-pos.		6-pos.		8-pos.	
A		A		A	
50 V AC / 60 V DC		30 V AC / 30 V DC		30 V AC / 30 V DC	
4 A		2 A		1.5 A	
Pin	Socket	Pin	Socket	Pin	Socket
					
1694347	-	1436521	-	1424238	-
-	1694376	-	1436534	-	1424237
1456019	-	1456022	-	1424236	-
1456048	-	1424244	-	-	-
-	1456129	-	1456132	-	1424235
-	1456158	-	1424243	-	-
-	1524789	-	-	-	-
1440096	1526169	-	-	-	-

Signal – M8, solder connection, PCB mounting		3-pos.	
For reflow soldering processes	Coding	A	
	Rated voltage	50 V AC / 60 V DC	
	Nominal current	4 A	
 Web code: #0219	Pin assignment		
		Two-piece, SMD contact carrier	
	Straight, SMD, in tray	1412225*	1412220
	Straight, SMD, on reel	1412248*	1412243
	Straight, shielded, SMD, in tray, additional gasket for the device when not plugged in	1412240*	1412235
	Straight, shielded, SMD, on reel, additional gasket for the device when not plugged in	1412263*	1412257
	Straight, SMD, in tray, additional gasket for the device when not plugged in	1412233*	1412227
	Straight, SMD, on reel, additional gasket for the device when not plugged in	1412255*	1412250
Two-piece, housing screw connections for SMD contact carriers			
	Screw versions, rear mounting, M12 x 1 screw fastening		
	Screw versions, front mounting, M10 x 0.75 screw fastening		
	M10 x 0.75 flat nut		
	Press-in versions for front mounting		

* Contact carrier with assembly pad

4-pos.		6-pos.		8-pos.	
A		A		A	
50 V AC / 60 V DC		30 V AC / 30 V DC		30 V AC / 30 V DC	
4 A		2 A		1.5 A	
Pin	Socket	Pin	Socket	Pin	Socket
					
1412226*	1412221	–	1412223	–	1412224
1412249*	1412244	–	1412246	–	1412247
1412241*	1412236	–	1412238	–	1412239
1412264*	1412258	–	1412261	–	1412262
1412234*	1412228	–	1412230	–	1412232
1412256*	1412251	–	1412253	–	1412254
Pin: 1412505 / Socket: 1412506					
Pin: 1412502 / Socket: 1412504					
1412508					
Pin: 1412500 / Socket: 1412501					

Signal – M5		3-pos.		4-pos.	
	Coding	A		A	
	Rated voltage	60 V		60 V	
	Nominal current	1 A		1 A	
	Conductor cross section	0.14 mm ²		0.14 mm ²	
 Web code: #0220	Pin assignment	Pin	Socket	Pin	Socket
					
Front mounting, pre-assembled with 0.5 m long litz wires					
	M5 fastening thread	1530582	1530605	1530595	1530618
	Flat nut with M5 thread	1535901			
Rear mounting, one-piece for wave soldering processes					
	M5 fastening thread	1530621	1530647	1530634	1530650
	Flat nut with M5 thread	1535901			

Data – M12 for networks		4-pos.		8-pos.		
	Coding	D		A		
	Rated voltage	250 V		30 V		
	Nominal current	4 A		2 A		
	Conductor cross section	0.14/0.34 mm ²		0.14 mm ²		
 Web code: #0222	Pin assignment	Pin	Socket	Pin	Socket	
						
Front/screw mounting, with assembled cable						
Ethernet 	M16 x 1.5, can be positioned, water blue, cable type 93E	2 m	–	1405837	–	–
Rear/screw mounting, with assembled cable						
Ethernet 	M16 x 1.5, water blue, cable type 93E	2 m	–	1405866	–	–
	M16 x 1.5, water blue, cable type 94B	5 m	–	–	–	1407877
	M16 x 1.5, water blue, cable type 94C	2 m	–	–	–	1412820
Rear/screw mounting, for wave soldering processes						
Ethernet 	M16 x 1.5, one-piece, contact carrier, water blue		1456514	1456527	–	–
Rear/screw mounting, with assembled cable						
 	Pg9, green, cable type 93B	0.5 m	1437805	1437766	–	–
		1 m	1437818	1437779	–	–
		2 m	1437821	1437782	–	–
		5 m	1437834	1437795	–	–
	M16 x 1.5, green, cable type 93C	2 m	–	1416209	–	–
M16 x 1.5, green, cable type 93R	2 m	–	1416263	–	–	
Rear/screw mounting, for wave soldering processes						
 	M16 x 1.5, one-piece, contact carrier, green		1456556	1456569	–	–

See the Signal – M12 section for additional 4-pos., D-coded connectors and 8-pos., A-coded connectors

Data – M12 for networks		8-pos.	8-pos.	
	Coding	X (CAT6_A)	Y (hybrid)	
	Rated voltage	50 V AC / 60 V DC	30 V	
	Nominal current	0.5 A	0.5 A / 6 A	
	Conductor cross section	0.25 mm ²	0.14/0.5 mm ²	
 Web code: #0224	Pin assignment	Socket	Socket	
				
Rear/screw mounting, with assembled cable				
	Ethernet M16 x 1.5, water blue, cable type 94F	0.5 m	1424135	–
		1 m	1424148	–
		2 m	1424151	–
		5 m	1424164	–
	Hybrid M16 x 1.5, black, cable type 94H	0.5 m	–	1407504
		1 m	–	1407505
		2 m	–	1407506
		5 m	–	1407507
Rear/screw mounting, pre-assembled with 0.5 m long litz wires				
	Hybrid M16 x 1.5	–	1407618	
Rear/screw mounting, for wave soldering processes				
	Ethernet Hybrid M16 x 1.5, one-piece, wave soldering	1424177	1407503	
		Pg9, one-piece, wave soldering	1404741	–
Two-piece, contact carrier for wave and reflow soldering processes				
	Ethernet	Straight, shielded, THR , in blister pack	1402457	–
		Straight, shielded, THR , on reel	1413446*	–
		Straight, shielded, SMD , in tray	1411964*	–
		Angled, shielded, wave soldering	1424180	–
	Hybrid	Straight, shielded, THR , in blister pack	–	1405225
		Straight, shielded, THR , on reel	–	1413445*
		Straight, shielded, SMD , in tray	–	1411965*
		Angled, shielded, wave soldering	–	1424193

Housing screw connections for THR and wave soldering contact carriers, see Page 22.

Housing screw connections for SMD contact carriers, see Page 24.











* Contact carrier with assembly pad

Data – M12 for networks		4-pos.		8-pos.		
Coding		D		A		
Rated voltage		250 V		30 V		
Nominal current		4 A		2 A		
Conductor cross section		0.14/0.34 mm ²		0.14 mm ²		
 Web code: #0226	Pin assignment	Pin	Socket	Pin	Socket	
						
Rear/screw mounting, with assembled cable						
	Sercos the automation bus M16 x 1.5, red, cable type 93K	0.5 m	1419158	1419154	–	–
		1 m	1419159	1419155	–	–
		2 m	1419160	1419156	–	–
		5 m	1419161	1419157	–	–
Rear/screw mounting, for wave soldering processes						
	Sercos the automation bus M16 x 1.5, one-piece, contact carrier, red		1457979	1457966	–	–
Rear/screw mounting, with assembled cable						
	EtherCAT Technology Group M16 x 1.5, green, cable type 93G	0.5 m	1419138	1419134	–	–
		1 m	1419139	1419135	–	–
		2 m	1419140	1419136	–	–
		5 m	1419141	1419137	–	–
Rear/screw mounting, for wave soldering processes						
	EtherCAT Technology Group M16 x 1.5, one-piece, contact carrier, green		1456556	1456569	–	–
Rear/screw mounting, with assembled cable						
	VARAN M16 x 1.5, black, cable type 970	0.5 m	–	–	1429059	1429091
		1 m	–	–	1429062	1429101
		2 m	–	–	1429075	1429114
		5 m	–	–	1429088	1429127

See the Signal – M12 section for additional 4-pos., D-coded connectors and 8-pos., A-coded connectors

Data – M12 for fieldbuses		5-pos.		
	Coding	B		
	Rated voltage	60 V		
	Nominal current	4 A		
	Conductor cross section	0.34 mm ²		
 Web code: #0229	Pin assignment	Pin 	Socket 	
		Front/screw mounting, with assembled cable		
	M16 x 1.5, can be positioned, violet, cable type 910	0.5 m	1525555	1525597
		1 m	1525568	1525607
		2 m	1519561	1519574
		5 m	1525571	1525610
		Rear/screw mounting, with assembled cable		
	Pg9, violet, cable type 910	0.5 m	1437481	1437449
		1 m	1437494	1437452
		2 m	1437504	1437465
		5 m	1437517	1437478
	M16 x 1.5, violet, cable type 910	0.5 m	1534342	1534384
		1 m	1534355	1534397
		2 m	1534368	1534407
		5 m	1534371	1534410
Rear/screw mounting, for wave soldering processes				
	M16 x 1.5, one-piece, contact carrier, violet		1456475	1456488

See the Signal – M12 section for additional 5-pos., B-coded connectors

Data – M12 for fieldbuses		5-pos.		
	Coding	B		
	Rated voltage	60 V		
	Nominal current	4 A		
	Conductor cross section	0.34 mm ²		
 Web code: #0230	Pin assignment	Pin 	Socket 	
		Front/screw mounting, with assembled cable		
  	M16 x 1.5, green, cable type 910	0.5 m	1529629	1529742
		1 m	1530223	1529755
		2 m	1529726	1529768
		5 m	1529739	1529771
Rear/screw mounting, with assembled cable				
  	Pg9, green, cable type 900	0.5 m	1437643	1437601
		1 m	1437656	1437614
		2 m	1437669	1437627
		5 m	1437672	1437630
	Pg 9 EMC nut		1440177	
	M16 x 1.5, green, cable type 900	0.5 m	1534504	1534546
		1 m	1534517	1534559
		2 m	1534520	1534562
5 m		1534533	1534575	
M16 x 1.5 EMC nut		1440164		
Rear/screw mounting, for wave soldering processes				
  	M16 x 1.5, one-piece, contact carrier, green		1456572	1456585
		M16 x 1.5 EMC nut		1440164





See the Signal – M12 section for additional 5-pos., B-coded connectors



Data – M12 for fieldbuses		5-pos.		
	Coding	A		
	Rated voltage	60 V		
	Nominal current	4 A		
	Conductor cross section	0.25/0.34 mm ²		
 Web code: #0231	Pin assignment	Pin	Socket	
				
Front/screw mounting, with assembled cable				
 	M16 x 1.5, violet, cable type 920	0.5 m	1525623	1525678
		1 m	1525636	1525681
		2 m	1525649	1525694
		5 m	1525652	1525704
Rear/screw mounting, with assembled cable				
 	Pg9, violet, cable type 920	0.5 m	1437562	1437520
		1 m	1437575	1437533
		2 m	1437588	1437546
		5 m	1437591	1437559
	Pg 9 EMC nut		1440177	
	M16 x 1.5, violet, cable type 920	0.5 m	1534423	1534465
		1 m	1534436	1534478
		2 m	1534449	1534481
		5 m	1534452	1534494
	M16 x 1.5 EMC nut		1440164	
Rear/screw mounting, for wave soldering processes				
 	M16 x 1.5, one-piece, contact carrier, violet		1456491	1456501
	M16 x 1.5 EMC nut		1440164	





See the Signal – M12 section for additional 5-pos., A-coded connectors

Data – M12 for fieldbuses		4-pos.		
	Coding	A		
	Rated voltage	250 V		
	Nominal current	4 A		
	Conductor cross section	0.34 mm ²		
 Web code: #0232	Pin assignment	Pin 	Socket 	
		Rear/screw mounting, with assembled cable		
 	M16 x 1.5, red, cable type 990	0.5 m	–	1559819
		1 m	–	1559822
		2 m	–	1559835
		5 m	–	1559848
	Pg9, red, cable type 990	0.5 m	–	1437847
		1 m	–	1437850
		2 m	–	1437863
		5 m	–	1437876
Rear/screw mounting, for wave soldering processes				
 	M16 x 1.5, one-piece, contact carrier, red		1457856	1457869
Front/screw mounting, pre-assembled with 0.5 m long litz wires				
 	Pg9, shielded	1431432	1431429	
	Pg9 flat nut		1504084	
Rear/screw mounting, for wave soldering processes, shielded				
 	M16 x 1.5, one-piece, stainless steel (1.4404)		1554746	1554733
	M16 x 1.5, one-piece, contact carrier, yellow		1457872	1457885
	M16 x 1.5, one-piece, contact carrier, blue		1457953	1457940

See the Signal – M12 section for additional 4-pos., A-coded connectors

Data – M12 for USB		USB	
 Web code: #0235	Pin assignment		
Rear/screw mounting, for wave soldering processes			
 	M12 x 1, Mini-B USB 2.0	1440711	-

Data – M12 for FO			FO
 Web code: #0236			
Rear/screw mounting, for wave soldering processes			
	M16 x 1.5, fiber optic transceiver	-	1416716

Data – M8 for fieldbuses		5-pos.		
	Coding	B		
	Rated voltage	30 V AC / 30 V DC		
	Nominal current	3 A		
	Conductor cross section	0.25 mm ²		
 Web code: #0237	Pin assignment	Pin 	Socket 	
		Front mounting, pre-assembled with 0.5 m long litz wires		
 	M10 fastening thread	1424234	1424233	
Rear mounting, for wave soldering processes				
 	M8 fastening thread, straight, shielded	1424242	–	
	M8 fastening thread, angled, shielded	1424240	–	
	M10 fastening thread, straight, shielded	–	1424241	
	M10 fastening thread, angled, shielded	–	1424239	
Two-piece, contact carrier for reflow soldering processes				
 	Straight, SMD in tray	–	1412222	
	Straight, SMD on reel	–	1412245	
	Straight, SMD in tray, additional gasket for the device when not plugged in		–	1412229
		Shielded	–	1412237
	Straight, SMD on reel, additional gasket for the device when not plugged in		–	1412252
		Shielded	–	1412259

Housing screw connections for SMD contact carriers, see Page 28.

Power – M12 up to 16 A / 630 V		3 (2+PE)-pos.	
	Coding	S (AC)	
	Rated voltage	630 V	
	Nominal current	16 A	
	Conductor cross section	1.5 mm ²	
 Web code: #0238	Pin assignment	Pin	Socket
		 	
Front mounting, pre-assembled with 0.5 m long litz wires			
	M16 x 1.5 fastening thread, one-piece	1411655	1411654
	M16 x 1.5 flat nut		
new 	M16 x 1.5 fastening thread, XL versions, wrench size 19	–	–
	M16 x 1.5 flat nut	–	–
	25 mm square flange, modular, mounting holes 4 x Ø 2.7 mm	–	–
	Pre-assembled contact carrier, modular	–	–
Rear mounting, pre-assembled with 0.5 m long litz wires			
	M16 x 1.5 fastening thread, one-piece	1411653	1411652
new 	M16 x 1.5 fastening thread, XL versions, wrench size 19	–	–

¹⁾ Articles are available from the third quarter 2016



4 (3+PE)-pos.		4-pos.		5 (4+PE)-pos.		5 (4+PE)-pos.		6 (5+PE)-pos.	
S (AC)		T (DC)		K (AC)		L (DC)		M (AC)	
630 V		60 V		630 V		63 V		630 V	
12 A		12 A		16 A		16 A		8 A	
1.5 mm ²		1.5 mm ²		2.5 mm ²		2.5 mm ²		1.5 mm ²	
Pin	Socket	Pin	Socket	Pin	Socket	Pin	Socket	Pin	Socket
1424139	1424137	1424140	1424138	-	-	-	-	-	-
1504097				-	-	-	-	-	-
1411607	1411605	1411608	1411606	1415291 ¹⁾	1415292 ¹⁾	1415295 ¹⁾	1415296 ¹⁾	1415300 ¹⁾	1415301 ¹⁾
1504097									
1424131				-	-	-	-	-	-
1424129	-	1424130	-	-	-	-	-	-	-
1424132	1424133	1424136	1424134	-	-	-	-	-	-
1411603	1411598	1411604	1411599	1415293 ¹⁾	1415294 ¹⁾	1415297 ¹⁾	1415299 ¹⁾	1415302 ¹⁾	1415303 ¹⁾

Power – M12 up to 16 A / 630 V		4 (3+PE)-pos.		4-pos.	
For reflow soldering processes	Coding	S (AC)		T (DC)	
	Rated voltage	630 V		60 V	
	Nominal current	12 A		12 A	
 Web code: #0240	Pin assignment	Pin	Socket	Pin	Socket
					
Two-piece, THR contact carrier					
	Straight, THR, in blister pack	1406410	1406409	1406396	1406411
	Straight, THR, on reel	1418343	1418344	1418339*	1418340*
	Straight, shielded, THR, in blister pack	–	–	1406397	1406412
	Straight, shielded, THR, on reel	–	–	1418341*	1418342*
Two-piece SMD contact carriers					
	Straight, SMD, in tray	–	–	1411931*	1411918
	Straight, SMD, on reel	–	–	1411989*	1411981
	Straight, shielded, SMD, in tray	–	–	–	1411967
	Straight, shielded, SMD, on reel	–	–	–	1412019
	Straight, SMD, in tray, additional gasket for the device when not plugged in	–	–	1411948*	–
	Straight, SMD, on reel, additional gasket for the device when not plugged in	–	–	1412003*	–
	Straight, shielded, SMD, in tray, additional gasket for the device when not plugged in	–	–	1411962*	–
	Straight, shielded, SMD, on reel, additional gasket for the device when not plugged in	–	–	1412017*	–

Housing screw connections for S- and T-coded THR contact carriers, see Page 22.

Housing screw connections for T-coded SMD contact carriers, see Page 24.

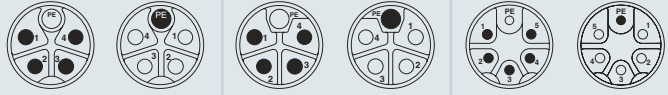
* Contact carrier with assembly pad

Power – M12 up to 16 A / 630 V		5 (4+PE)-pos.	5 (4+PE)-pos.	6 (5+PE)-pos.				
For wave soldering and reflow soldering processes	Coding	K (AC)	L (DC)	M (AC)				
	Rated voltage	630 V	63 V	630 V				
	Nominal current	16 A	16 A	8 A				
 Web code: #0240	Pin assignment	Pin	Socket	Pin	Socket	Pin	Socket	
								
One-piece, rear/screw mounting								
new		M16 x 1.5, XL versions, wrench size 19, wave soldering	–	–	1415337 ¹⁾	1415338 ¹⁾	–	–
Two-piece, THR contact carrier								
new		Straight, THR, in tray*	1420819 ¹⁾	1420821 ¹⁾	1420817 ¹⁾	1420818 ¹⁾	1420822 ¹⁾	1420823 ¹⁾
		Straight, THR, on reel*	1420830 ¹⁾	1420831 ¹⁾	1420828 ¹⁾	1420829 ¹⁾	1420832 ¹⁾	1420833 ¹⁾
		Straight, shielded, THR, in tray*	–	–	1421314 ¹⁾	1421315 ¹⁾	–	–
		Straight, shielded, THR, on reel*	–	–	1421317 ¹⁾	1421318 ¹⁾	–	–
Two-piece, housing screw connections for K-, L- and M-coded THR contact carriers								
new		Screw versions, front mounting, M14 x 1 screw fastening	Pin: 1420824 ¹⁾ / Socket: 1420825 ¹⁾					
		M14 x 1 flat nut	1412077					
		Screw versions, rear mounting, M15 x 1 screw fastening	Pin: 1420826 ¹⁾ / Socket: 1420827 ¹⁾					

K and M-coding: PE applied to housing, L-coding: PE separately applied to the PCB

* contact carrier with assembly pad

¹⁾ Articles are available from the third quarter 2016

Signal – M12 connectors that can be assembled

 Web code: #0242

	Coding	Design	4-pos.		5-pos.		8-pos.	
			Pin	Socket	Pin	Socket	Pin	Socket
Screw connection, SPEEDCON knurl, cable outer Ø: 4 mm ... 6 mm								
	A - Standard	straight	1542952	1543029	1542965	1543032		
	A - Standard	angled	1542981	1543058	1542994	1543061		
Screw connection, SPEEDCON knurl, cable outer Ø: 6 mm ... 8 mm								
	A - Standard	straight			1542978	1543045		
	A - Standard	angled			1543003	1543414		
Screw connection, metal knurl, cable outer Ø: 4 mm ... 6 mm								
	A - Standard	straight	1662528	1681127	1663116	1662968		
	A - Standard	angled	1681101	1681143	1663129	1662984		
Screw connection, metal knurl, cable outer Ø: 6 mm ... 8 mm								
	A - Standard	straight	1523230	1696439	1681460	1681486	1513334	1513347
	A - Standard	angled			1681473	1681499		
Screw connection, metal knurl, cable outer Ø: 4 mm ... 6 mm, with SKINTOP® screw connection								
	A - Standard	straight	1556870	1430381	1456466	1559000		
Screw connection, metal knurl, cable outer Ø: 6 mm ... 8 mm, with SKINTOP® screw connection								
	A - Standard	straight			1556825	1556838		
	A - Standard	angled			1561742	1556812		
Screw connection, metal knurl, cable outer Ø: 4 mm ... 6 mm, shielded								
	A - Standard	straight	1693830	1694295	1693416	1694305		
	A - Standard	angled	1694279		1693429			
Screw connection, metal knurl, cable outer Ø: 6 mm ... 8 mm, shielded								
	A - Standard	straight	1501540	1515170	1694266	1694318	1511857	1511860
	A - Standard	angled			1694282	1430433		

Signal – M12 connectors that can be assembled

i Web code: #0243

	Coding	Design	4-pos.		5-pos.		8-pos.	
			Pin	Socket	Pin	Socket	Pin	Socket
Spring-cage connection								
	A - Standard	straight	1432635	1432619	1432567	1432583		
	A - Standard	angled	1432606	1432622	1432570	1432596		
Spring-cage connection, shielded								
	A - Standard	straight	1432729	1432745	1432648	1432664		
	A - Standard	angled	1432732	1432758	1432651	1432677		
IDC connection, conductor cross section: 0.14 mm² ... 0.34 mm²								
	A - Standard	plastic knurl	1641714	1641701				
	A - Standard	SPEEDCON knurl	1521575	1521588				
	A - Standard	metal knurl	1641691	1641688				
IDC connection, conductor cross section: 0.34 mm² ... 0.75 mm²								
	A - Standard	plastic knurl	1641769	1641756				
	A - Standard	SPEEDCON knurl	1521591	1521601				
	A - Standard	metal knurl	1641785	1641772				
IDC connection, conductor cross section: 0.14 mm² ... 0.75 mm², shielded								
	A - Standard	straight	1413993	1413994	1413991	1413992	1414610	1414611

Signal – M12 connectors that can be assembled, high pos.

i Web code: #0245

	Coding	Design	12-pos.		17-pos.			
			Pin	Socket	Pin	Socket		
Piercecon® connection, conductor cross section: 0.14 mm²								
	A - Standard	straight	1559592	1559631	1559602	1559644		
Solder connection, conductor cross section: 0.08 mm² ... 0.25 mm², shielded								
	A - Standard	straight	1404410	1404411				
	A - Standard	angled	1404412	1404413				

Signal – M8 connectors that can be assembled

 Web code: #0246

	Design	3-pos.		4-pos.	
		Pin	Socket	Pin	Socket
Solder connection, conductor cross section: 0.08 mm² ... 0.25 mm²					
	straight	1681156	1681172	1681169	1681185
	angled	1699902	1529399	1554209	1513444
Solder connection, shielded, conductor cross section: 0.08 mm² ... 0.25 mm²					
	straight	1506901	1506927	1506914	1506930
	angled	1436453	1436479	1436466	1436482
Screw connection, conductor cross section: 0.14 mm² ... 0.5 mm²					
	straight	1501252	1506888	1501265	1506891
	angled	1407583	1407582	1407585	1407584
Screw connection, shielded, conductor cross section: 0.14 mm² ... 0.5 mm²					
	straight	1542884	1542907	1542897	1542910
IDC connection, conductor cross section: 0.08 mm² ... 0.25 mm²					
	Straight	1441008	1441040	1441011	1441053
IDC connection, conductor cross section: 0.25 mm² ... 0.5 mm²					
	straight	1441024	1441066	1441037	1441079

Data – M12 connectors that can be assembled

i Web code: #0249





	Coding	Design	4-pos.		5-pos.		8-pos.	
			Pin	Socket	Pin	Socket	Pin	Socket
Spring-cage connection, shielded, for field buses								
	INTERBUS	straight			1432800	1432826		
		angled			1432813	1432839		
	PROFIBUS	straight			1432842	1432868		
		angled			1432855	1432871		
	DeviceNet™	straight			1432761	1432787		
		angled			1432774	1432790		
Spring-cage connection, shielded, for networks								
	PROFINET	straight	1436738	1436741				
		angled	1436754	1436767				
IDC connection, shielded, for networks								
new								
	Ethernet	straight	1411066	1411069			1421679	1421680
		angled	1553624	1553637			1553653	1553666
	Ethernet CAT 6 _A	straight					1411043	1414586
	PROFINET	straight	1411068	1411071				
		angled	1554539	1554542				
	PROFINET CAT 6 _A	straight					1411044	1414587
Piercecon connection, shielded, for networks								
	Ethernet CAT6 _A	straight					1417430	
		angled					1417443	

Power – M12 connectors that can be assembled





i Web code: #0252

	Coding	Design	4-pos. (DC)		3+PE-pos. (AC)		
			Pin	Socket	Pin	Socket	
Screw connection, conductor cross section up to 1.5 mm²							
	T power	straight	1404643	1404644			
		angled	1408988	1408989			
	S power	straight			1404641	1404642	
		angled			1408985	1408987	

Signal – Cable connector with IDC

i Web code: #0243				new 		
	Conductor cross section [mm ²]	0.14 ... 0.34	0.34 ... 0.75	0.5 ... 1.5	0.14 ... 0.75	
No. of pos.	unshielded	unshielded	unshielded	shielded		
3			1414702			
4	1641879	1642140	1414698	1414418		
5			1414742	1414417		
8				1414612		

Data – Cable connector with IDC

i Web code: #0249	new 	new 	new 	new 	new 	
	Conductor cross section [mm ²]	0.14 ... 0.34	0.25 ... 0.5	0.14 ... 0.34	0.25 ... 0.5	0.25 ... 0.75
	Ethernet CAT6 _A	PROFINET CAT 6 _A	Ethernet 4-pos.	PROFINET 4-pos.	PROFIBUS	
	1414412	1414413	1414415	1414416	1420426	

Signal – cables with M8 or M12 connectors

i Web code: #0283						
	Cable length	Signal cable M8, 3-pos.	Signal cable M8, 4-pos.	Signal cable M12, 3-pos.	Signal cable M12, 4-pos.	Signal cable M12, 5-pos.
Straight plug, free cable end						
3 m	1681677	1681790	1668027	1668056	1669770	1682744
5 m	1681680	1681800	1668030	1668069	1669783	1682731
10 m	1693584	1694143	1682566	1682993	1683361	1500732
Straight socket, free cable end						
3 m	1669725	1681855	1694499	1668111	1669835	1682948
5 m	1669628	1681868	1683510	1668124	1669848	1682951
10 m	1694101	1683484	1693034	1683002	1683374	1500758
Straight plug, straight socket						
0.3 m	1681907	–	–	1668357	1681583	–
0.6 m	1681910	–	–	1668360	1681596	–
1.5 m	1681923	–	–	1668373	1681606	–
3 m	1681936	–	–	1668386	1681619	–
Angled socket, free cable end						
3 m	1669741	1681884	1694512	1668234	1669864	1682977
5 m	1669631	1681897	1694525	1668247	1669877	1682980
10 m	1694169	1694172	1694538	1681389	1694541	1500761

Additional cables with connectors in sizes M5 to M40 for signals, data and power can be found at phoenixcontact.com

Data – Network cables with M12 connectors

i Web code: #0284



Cable length	Ethernet X-coded	Ethernet D-coded	PROFINET D-coded	PROFIBUS B-coded	DeviceNet/ CANopen A-coded	CC-Link A-coded
--------------	------------------	------------------	------------------	------------------	-------------------------------	-----------------

Straight plug, free cable end

1 m	1407467	1407356	1407495	–	–	–
2 m	1407468	1407357	1407496	1518025	1518177	1558328
5 m	1407469	1407358	1407497	1518038	1518180	1558331
10 m	1407470	1407359	1407498	1518041	1518193	1558344
15 m	–	–	–	–	–	1558357
Variable	1408648	1408713	1408640	1538050	1538115	–

Straight socket, free cable end

1 m	–	1407380	1407528	–	–	–
2 m	–	1407381	1407529	1518067	1518216	1558360
5 m	–	1407382	1407530	1518070	1518229	1558373
10 m	–	1407383	1407531	1518083	1518232	1558386
15 m	–	–	–	1518096	1518245	1558399
Variable	–	1408697	1408623	1538076	1538131	–

Straight plug, straight socket

0.3 m	–	–	–	1518106	1518258	1558409
0.5 m	–	–	–	1518119	1518261	–
0.6 m	–	–	–	–	–	1558412
1 m	–	1407400	1407553	1518122	1518274	1558425
2 m	–	1407401	1407554	1518135	1518287	1558438
5 m	–	1407402	1407555	1518148	1518290	1558441
10 m	–	1407403	1407556	1518151	1518300	1558454
15 m	–	–	–	1518164	1518313	1558467
Variable	–	1408692	1408617	1538092	1538157	–

Straight plug, straight plug

1 m	1407483	1407376	1407524	–	–	–
2 m	1407484	1407377	1407525	–	–	–
5 m	1407485	1407378	1407526	–	–	–
10 m	1407486	1407379	1407527	–	–	–
Variable	1408644	1408706	1408634	1433252	1433294	–



Termination resistors, M12 connector

PROFIBUS	DeviceNet/ CANopen	CC-Link
1507803	1507816	1558470

Additional cables with connectors in sizes M5 to M40 for signals, data and power can be found at phoenixcontact.com

Accessories

 Web code: #0559

Size	M5		M8		M12		
	Connectors	Sockets	Connectors	Sockets	Connectors	Sockets	
Locking screw							
	Plastic	–	1533288	–	1682540	–	1680539
	Metal	–	–	–	–	–	1503302 ¹⁾ 1414148 ²⁾
	Stainless steel V4A	–	–	–	–	–	1555538
Locking screw for SPEEDCON versions							
	Plastic	–	–	–	–	–	1553129
Sealing cap							
	Plastic	–	–	–	–	1560251	–
	Metal	–	–	–	–	1430488	–
Sealing elements for non-assigned housing cut-outs							
	Sealing plug, plastic, for Pg9/Pg11					1670235	
	Locking screw, metal, M16 x 1.5					1453368	
Plastic sealing caps and locking screws with retaining strap							
	For cables			1430857	1430860	1430873	1430899
	With Ø 3 mm fastening eye			–	1441105	–	–
	With Ø 8 mm fastening eye			1441082	–	–	–
	With Ø 12 mm fastening eye			–	1441095	1456187	–
	With Ø 15 mm fastening eye			–	–	1456190	1456200
Metal sealing caps and locking screws with fastening chain							
	With Ø 16 mm fastening eye			–	–	1430491	1414147

¹⁾ With slotted screw head

²⁾ With hexagonal screw head

Accessories

 Web code: #0559

EMC hexagonal nut with fine tothing for device connectors

	<p>With fine tothing facing inwards. This prevents visible scratch marks from appearing on the device surface.</p>	M12 x 1	1440151
		M16 x 1.5	1440164
		Pg9	1440177

Seal for device connector

	Seal for M8 socket	1437070
	Flat gasket for M12 fastening thread	1424275
	Flat gasket for M16 fastening thread	1430394
	Flat gasket for Pg9 fastening thread	1556320

Pin assignments and litz wire colors

Signal

M5 device connectors

Pin assignments

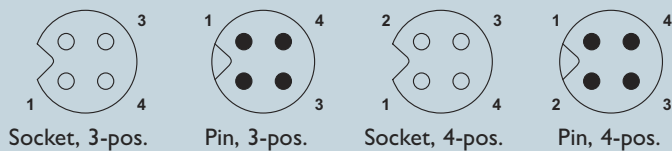

M8 device connectors

Pin assignments

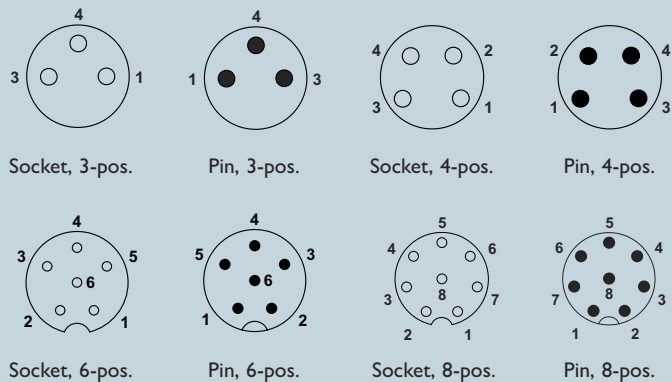

M12 device connectors

Pin assignments

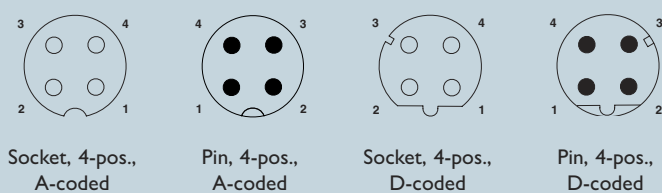

Litz wire colors

Assignment: M5 pin/socket

Pin	Wire color			
	3-pos.		4-pos.	
1	BN	■	BN	■
2	–	■	WH	■
3	BU	■	BU	■
4	BK	■	BK	■

Litz wire colors

Assignment: M8 pin/socket

Pin	Wire color			
	3-pos.		4-pos.	
1	BN	■	BN	■
2	–	■	WH	■
3	BU	■	BU	■
4	BK	■	BK	■
5	–	■	–	■
6	–	■	–	■

Assignment: M8 pin/socket

Pin	Wire color			
	6-pos.		8-pos.	
1	BN	■	WH	■
2	WH	■	BN	■
3	BU	■	GN	■
4	BK	■	YE	■
5	GY	■	GY	■
6	PK	■	PK	■
7	–	■	BU	■
8	–	■	RD	■

Litz wire colors

Assignment: M12 pin/socket

Pin	4-pos. A-coded		4-pos. D-coded	
	1	BN	■	YE
2	WH	■	WH	■
3	BU	■	OG	■
4	BK	■	BU	■

Signal

M12 device connectors

Pin assignments

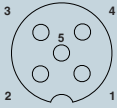

Socket, 5-pos.,
A-coded

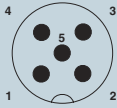

Pin, 5-pos.,
A-coded

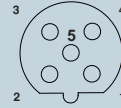

Socket, 5-pos.,
B-coded

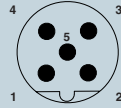

Pin, 5-pos.,
B-coded

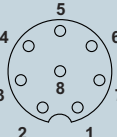

Socket, 8-pos.

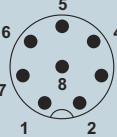

Pin, 8-pos.

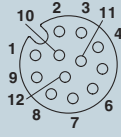

Socket, 12-pos.

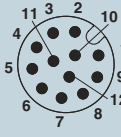

Pin, 12-pos.

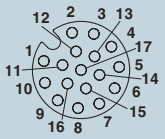

Socket, 17-pos.

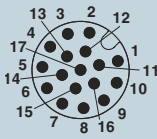

Pin, 17-pos.

Assignment: M12 pin/socket

Pin	8-pos.	12-pos.
1	WH	BN
2	BN	BU
3	GN	WH
4	YE	GN
5	GY	PK
6	PK	YE
7	BU	BK
8	RD	GY
9	–	RD
10	–	VT
11	–	GYPK
12	–	RDBU

Litz wire colors

Assignment: M12 pin/socket

Pin	5-pos. A-coded	5-pos. B-coded
1	BN	BN
2	WH	WH
3	BU	BU
4	BK	BK
5	GY	GY

Assignment: M12 pin/socket

Pin	17-pos.
1	BN
2	BU
3	WH
4	GN
5	PK
6	YE
7	BK
8	GY
9	RD
10	VT
11	GYPK
12	RDBU
13	WHGN
14	BNGN
15	WHYE
16	YEBN
17	WHGY

Data

M8 device connectors

Pin assignments

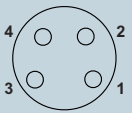

Socket, 4-pos.
Ethernet

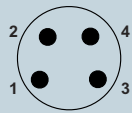

Pin, 4-pos.
Ethernet

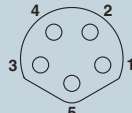

Socket, 5-pos.,
DeviceNet™,
B-coded

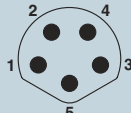

Pin, 5-pos.,
DeviceNet™,
B-coded

Assignment: CANopen®/DeviceNet™, 5-pos., B-coded

Pin	Wire color	Signal DeviceNet™
1	Shield	Drain
2	RD	V+
3	WH	CAN_H
4	BK	V–
5	BU	CAN_L

Assignment: Ethernet, 4-pos., A-coded

Pin	Wire color	Signal Ethernet
1	YE	TD+
2	OG	TD–
3	WH	RD+
4	BU	RD–

Pin assignments and litz wire colors

Data

M12 device connectors

Pin assignments

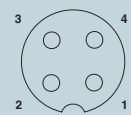

Socket, 4-pos., A-coded

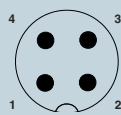

Pin, 4-pos., A-coded

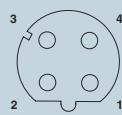

Socket, 4-pos., D-coded

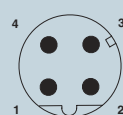

Pin, 4-pos., D-coded

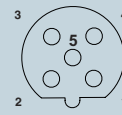

Socket, 5-pos., B-coded

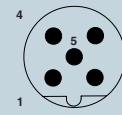

Pin, 5-pos., B-coded

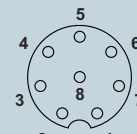

Socket, 8-pos., A-coded



Pin, 8-pos., A-coded

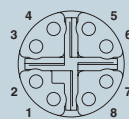

Socket, 8-pos., X-coded

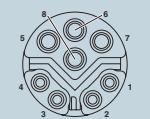

Socket, 8-pos., Y-coded

Litz wire colors

Assignment: PROFIBUS, 5-pos., B-coded

Pin	Wire color	Signal PROFIBUS
1	–	–
2	GN	A cable
3	–	–
4	RD	B cable
5	Filler litz wire	–

Shield on housing

Assignment: CANopen®, 5-pos., A-coded

Pin	Wire color	Signal CANopen®
1	Shield	Drain
2	RD	V+
3	BK	V–
4	WH	CAN_H
5	BU	CAN_L

Shield on housing

Assignment: DeviceNet, 5-pos., A-coded

Pin	Wire color	Signal DeviceNet
1	Shield	Drain
2	RD	V+
3	BK	V–
4	WH	CAN_H
5	BU	CAN_L

Shield on housing

Assignment: INTERBUS, 5-pos., B-coded

Pin	Wire color	Signal
1	YE	DO
2	GN	<u>DO</u>
3	GY	DI
4	PK	<u>DI</u>
5	BN	COM
–	WH	NC

Shield on housing

Assignment: PROFINET, EtherCAT, Sercos, 4-pos., D-coded

Pin	Wire color	Signal
1	YE	TD+
2	WH	RD+
3	OG	TD–
4	BU	RD–

Assignment: Ethernet, 4-pos., D-coded

Pin	Wire color	Signal Ethernet
1	WHOG	TD+
2	WHGN	RD+
3	OG	TD–
4	GN	RD–

Shield on housing

Assignment: FOUNDATION Fieldbus, 4-pos., A-coded

Pin	Wire color	Signal
1	BU	DATA–
2	OG	DATA+
3		Shield
4		

Data

M12 device connectors

Litz wire colors

Assignment: Ethernet, 8-pos., A-coded

Pin	Wire color	Signal Ethernet
1	WHBU	D3-
2	WHBN	D4+
3	BN	D4-
4	OG	D1-
5	WHGN	D2+
6	WHOG	D1+
7	BU	D3+
8	GN	D2-

Assignment: Ethernet, 8-pos., X-coded

Pin	Wire color	Signal Ethernet
1	WHOG	D1+
2	OG	D1-
3	WHGN	D2+
4	GN	D2-
5	WHBN	D4+
6	BN	D4-
7	WHBU	D3-
8	BU	D3+

Assignment: Ethernet hybrid, 8-pos., Y-coded

Pin	Wire color	Signal Ethernet
1	WHOG	TD+
2	OG	TD-
3	WHGN	RD+
4	GN	RD-
5	BU	
6	WH	
7	BN	
8	BK	

Assignment: Varan, 8-pos., A-coded

Pin	Wire color	Signal
1	n. c.	
2	OG	TD-
3	WHOG	TD+
4	n. c.	
5	WHGN	RD+
6	BU	
7	BN	
8	GN	RD-

Assignment: AS-Interface, 4-pos., A-coded

Pin	Wire color	Signal
1	BU	AS-i+
2	WH	
3	BN	AS-i-
4	BK	

Assignment: CC-Link, 4-pos., A-coded

Pin	Wire color	Signal
1	Shield	SLD
2	WH	DS
3	YE	DG
4	BU	DA

Power

M12 device connectors

Pin assignments



Socket, 2+PE, S-coded



Pin, 2+PE, S-coded



Socket, 3+PE, S-coded



Pin, 3+PE, S-coded



Socket, 4-pos., T-coded



Pin, 4-pos., T-coded



Socket, 4+PE, K-coded

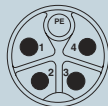

Pin, 4+PE, K-coded

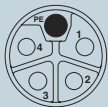

Socket, 4+PE, L-coded

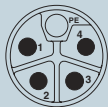

Pin, 4+PE, L-coded

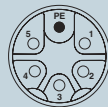

Socket, 5+PE, M-coded

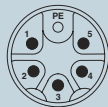

Pin, 5+PE, M-coded

Litz wire colors

Assignment: 2+PE, S-coded

Pin	Wire color
1	BK1
3	BK2
PE	GNYE

Assignment: 3+PE, S-coded

Pin	Wire color
1	BK1
2	BK2
3	BK3
PE	GNYE

Assignment: 5+PE, M-coded

Pin	Wire color
1	BK1
2	BK2
3	BK3
4	BK4
5	BK5
PE	GNYE

Assignm.: 4-pos., T-coded

Pin	Wire color
1	BN
2	WH
3	BU
4	BK

Assignm.: 4+PE, K-coded

Pin	Wire color
1	BK1
2	BK2
3	BK3
4	BK4
PE	GNYE

Assignm.: 4+PE, L-coded

Pin	Wire color
1	BK
2	BU
3	BN
4	WH
PE	GNYE



Always up-to-date, always available to you. Here you'll find everything on our products, solutions and service:

phoenixcontact.com

Product range

- Cables and wires
- Connectors
- Controllers
- Electronics housing
- Electronic switchgear and motor control
- Fieldbus components and systems
- Functional safety
- HMIs and industrial PCs
- I/O systems
- Industrial communication technology
- Industrial Ethernet
- Installation and mounting material
- Lighting and signaling
- Marking and labeling
- Measurement and control technology
- Modular terminal blocks
- Monitoring
- PCB terminal blocks and PCB connectors
- Power supply units and UPS
- Protective devices
- Relay modules
- Sensor/actuator cabling
- Software
- Surge protection and interference filters
- System cabling for controllers
- Tools
- Wireless data communication

USA:

PHOENIX CONTACT Inc.
P.O. Box 4100
Harrisburg
PA 17111-0100
Phone (717) 944-1300
Fax (717) 944-1625
phoenixcontact.com

Canada:

PHOENIX CONTACT Ltd.
8240 Parkhill Drive
Milton, Ontario L9T 5V7
Toll Free (800) 890-2820
Phone (905) 864-8700
Fax (905) 890-0180
phoenixcontact.ca