

Sensor/Actuator Cabling and Industrial Connectors

2015/2016

4





Sensor/actuator cabling and industrial connectors



Terminal blocks

- Terminal blocks



Interface technology and switching devices

- Electronic switching devices and motor control
- Measurement and control technology
- Monitoring
- Relay modules
- System cabling for controllers



Marking systems, tools, and mounting material

- Marking and labeling
- Tools
- Installation and mounting material



Control technology, I/O systems, and automation infrastructure

- Lighting and signaling
- Fieldbus components and systems
- Functional Safety
- HMIs and industrial PCs
- I/O systems
- Industrial Ethernet
- Industrial communication technology
- Software
- Controllers
- Wireless data communication



Surge protection and power supplies

- Surge protection and interference suppression filters
- Power supplies and UPS
- Protective devices

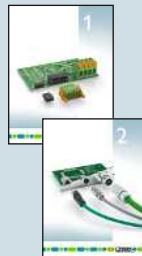

PCB connection technology and electronics housing 2013/14

- PCB terminal blocks and PCB connectors
- Electronics housing

Connection technology for field devices 2013/14

- Connectors
- Cables and lines

Find out more with the web code

On some of the catalog pages, you can find our web codes: a number sign followed by a four-digit number combination.

i Web code: #1234 (example)

This allows you to reach information on our website quickly.

It couldn't be simpler:

1. Go to the Phoenix Contact website
2. Enter # and the number combination in the search field
3. Receive more information and product versions

Or use the direct link:

phoenixcontact.net/webcode/#1234

Information on these products can be found in the electronic product catalogs for 2013/14.







Or get the latest on all the new products and additional information directly in the product area of our website:

phoenixcontact.net/products



Also discover the Phoenix Contact catalog app interactively on your tablet.

Table of contents

Connection technology from Phoenix Contact Implement your individual connection for field cabling with the expertise of Phoenix Contact		4
Product range overview The illustrated table of contents will help you find the right product more quickly.		6
Connectors M5 to M12 sensor/actuator connectors, M17 to M58 power connectors, valve connectors		13
Sensor/actuator cabling Sensor/actuator cables in M5 to M40, connectors and boxes in M5 to M12, with SPEEDCON fast locking system as an option. M17 to M40		169
Data connectors and cables Connectors, flush-type connectors, and cables for fieldbuses and networks: M8, M12, 7/8", RJ45, SC-RJ, D-SUB, and USB.		319
Installation systems Panel feed-throughs, cable connectors, connectors, and distributors with QUICKON fast connection technology for easy installation.		451
Heavy-duty connectors HEAVYCON heavy-duty connectors for signal and power transmission. DUPLICON stackable connectors for flexible power distribution.		479
Installation and mounting material CES cable entry system for space-saving feed-through, plug assembly frames, cable glands, and service interfaces.		667
Charging connectors Charging systems for E-Mobility up to 400 A and connectors for power electronics up to 150 A.		713
Technical information General information on the degree of protection, properties of plastics, approvals, insulation coordination, etc.		728
Index		742



Screw connection

The screw connection is the most universal and globally accepted conductor connection technology. An important characteristic is the maintenance-free conductor contact. It is not necessary to tighten the terminal screw again. All kinds of copper cables can be clamped without pretreatment, thereby making gas-tight and reliable contact. The wire protector, which protects the individual litz wires from damage, is located between the screw and the conductor. It also performs a screw locking function to prevent release due to vibrations and temperature fluctuations. Splicing protection can be implemented in the form of ferrules. With a screw connection, several wires may also be clamped under one screw. The current-carrying parts of the screw connections are made of high-grade, strain-crack, and corrosion-proof copper alloys.

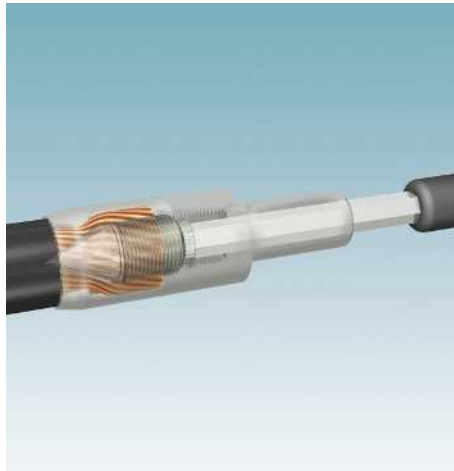

Axial screw connection

With this method, the wire end to be contacted is guided into the connection area of the pin or socket contact. A cone-shaped prong (part of the contact) is then screwed into the stranded wire from the front. The strands of the wire are radially pressed against the contact wall. This results in a gas-tight connection with long-term stability between the wire and contact. It is important that the specified tightening torque is observed. The prong is pressed in using a hexagon key which is applied to the front of the contact. This connection technology combines the advantages of screw and crimp connection. It requires very little space, is easy to execute, and only requires a standard Allen key.

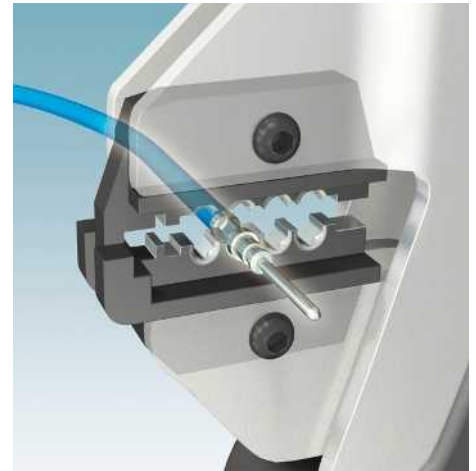

Crimp connection

The crimp connection impresses with its small space requirements and its cost-effective creation in series production. For a reliable connection, it is essential that the conductor cross section, the crimp contact, and the crimping tool are compatible. Furthermore, the crimping process must be monitored during large-scale production as the crimping tools are subject to a certain degree of wear.

Crimp connections can be established with the aid of crimping pliers or crimp machines through specific deformation of the crimping ranges of the contact. The requirements for crimp connections are defined in DIN EN 60352-2. Proof of the quality of a crimp connection can be seen in the tensile strength of the connection and crack-free deformation of the crimp contact. Crimping must not result in impermissible elongation of crimp contacts, as this would prevent them from latching correctly in the contact carrier. The contact is released using an unlocking tool. Assembly tools are also available for very thin conductors.



Spring connection

The spring connection contains a steel spring which pushes the stripped conductor against a busbar. The terminal point is opened with a standard screwdriver. After the conductor has been inserted into the clamping space, the screwdriver is removed and the conductor automatically makes contact. The contact force is independent of the user and a vibration-proof, gas-tight connection with long-term stability is established. The front connection provides an additional advantage. The conductor and screwdriver come in parallel from the same direction and are always within the user's field of vision. Contact inserts can thereby also be connected or re-wired even when mounted. All kinds of copper cables can be clamped without pretreatment, thereby making gas-tight and reliable contact. Splicing protection can also be implemented in the form of a ferrule.



Push-in connection

Stranded conductors with ferrules or solid conductors can be quickly and easily inserted directly into the connection without tools. The contact spring is formed in such a way that it opens automatically when the conductor is pushed in and thereby provides the required pressure force against the current bar for a gas-tight, vibration and shock-proof connection. With the aid of the orange pusher, the terminal block can be opened manually so that conductors with smaller cross sections can also be securely connected. To release the conductor, the orange pusher features a confusion-free and defined operating element. The conductive metals are made from high-grade copper alloys. All metal parts of the connection are made of corrosion-resistant materials.



QUICKON fast connection for single wires

The QUICKON connection is equipped with an IDC insulation displacement contact. The term "IDC" stands for Insulation Displacement Connection. With this connection method, a non-stripped wire with insulation is positioned in front of the gap of the insulation displacement contact and then pushed into the blade gap through insulation displacement. In so doing, the wire insulation is severed and a gas-tight contact is made between the wire and the contact. This can save at least 60% of connection time.

The connection force is independent of the user and completely reliable provided the permitted conductor cross sections and connection conditions are observed. Solid and stranded conductors can be rewired up to 10 times. However, the wire end should be cut off before connecting again.

QUICKON connections have proven themselves in numerous applications for Phoenix Contact over recent years, such as connectors, for COMBICON, and modular terminal blocks to CEE plug-in equipment from 0.14 to 6.0 mm².

Product range overview

Connectors



M8 connectors, for assembly
page 14



M12 connectors, for assembly
page 17



7/8" connectors, for assembly
page 24



Valve connectors, for assembly
page 26



M5 and M8 device connectors with litz wires
page 30



M12 device connectors with litz wire
page 33



M12 device connectors with square flange
page 38



7/8" device connectors with litz wires
page 49



M17 - signal connectors
page 58



M23 - signal connectors
page 74



M23 - feedback connectors
page 88



M23 - hybrid connectors
page 100



M17 - power connectors
page 110



M23 - power connectors
page 126



M40 - power connectors
page 138



M58 - power connectors
page 148

Sensor/actuator cabling



3-pos. sensor/actuator cables in M5, M8, and M12
page 170



4-pos. sensor/actuator cables in M5, M8, and M12
page 180



5-pos. sensor/actuator cables in M8 and M12
page 186



6-pos. sensor/actuator cable in M8
page 191



8-pos. sensor/actuator cables in M8 and M12
page 193



12 and 17-pos. sensor/actuator cables in M12 and M23
page 198



Cables with plastic molded M17 to M40 connectors
page 202



Cables with valve connector
page 214



Cables with valve connectors, Deutsch
page 230



Cables with valve connectors, Superseal
page 233



M8 and M12 Y-cables
page 234



M8 and M12 Y/T-distributors
page 238



M8 and M12 adapters
page 240



7/8" T-distributors
page 241



Valve plug adapters
page 242



M5 distributor boxes with metal thread
page 255

Product range overview



M8 distributor boxes with metal thread
page 246



M12 distributor boxes with plastic and metal thread
page 248



Distributor boxes with QUICKON fast connection
page 252



M12 distributor boxes, shielded
page 254



Cabling for the railway industry
page 256



Cabling for the food industry
page 258



Cabling for outdoor applications
page 260



Cabling for robots and drag chains
page 262



Cabling for power applications
page 264



Power connectors, size M12, for assembly
page 266



Power device connectors, size M12
page 267



Power cables, size M12 and 7/8"
page 271



Power distributors, size M12
page 280



Cable rings
page 282



Cable drum
page 283



Accessories
page 286

Data connectors and cables



M12 connectors for Gigabit Ethernet, for assembly page 324



M12 connectors for networks, for assembly page 325



Version 1 connectors page 330



Version 4 connectors page 334



Version 6 connectors page 336



Version 14 connectors page 344



IP20 connectors page 360



Accessories for network components page 370



Assembled cables with RJ45 or M12 connectors for networks page 382



Assembled fiber optic cables page 396



M12 connectors for fieldbuses page 406



M12 device connectors for fieldbuses page 408



Assembled cables with M8, M12 or 7/8" connectors for fieldbuses page 409



Cables, connectors, and distributors for AS-Interface page 426



D-SUB-based fieldbus connectors page 432



USB cables, socket inserts, and panel mounting frames, IP67 page 438

Product range overview

Installation system



H and T-distributors
1.5 mm² page 452
2.5 mm² page 461
6.0 mm² page 469



Cable connectors
1.5 mm² page 454
2.5 mm² page 463
6.0 mm² page 471



Panel feed-throughs
1.5 mm² page 456
2.5 mm² page 464
6.0 mm² page 472



Connectors
1.5 mm² page 459
2.5 mm² page 467
6.0 mm² page 473

Heavy-duty connectors



D7 - contact inserts
A3, A4 series page 484
D7, D8 series page 486
Q series page 488



D7 series housing
Plastic page 490
Metal page 491



D - contact inserts
A10 ... A16 series page 494
D15 ... D25 series page 498



D series housing
Plastic page 502
Metal page 503



B - contact inserts
D40 ... DD108 series page 512
B6 ... BBB64 series page 520
HV03 ... K series page 536



B - contact inserts
Modular contact inserts page 548



B - contact inserts
D40 ... D64 terminal adapters page 514
B6 ... B24 terminal adapters page 528



ADVANCE B series housing page 570



STANDARD B series housing page 571



EVO B series housing
Plastic page 572
Metal page 573



HPR B series housing page 626



Compact - contact inserts
Compact series page 630



Compact series housing page 632



Accessories for contact inserts and housing page 634



Stackable power distribution Connector sets page 656 Contact inserts page 658



Stackable power distribution Housing page 660

Installation and mounting material



Sealing frame for cable entry system page 668



Cable sleeves Rubber page 670 Thermoplastic page 672



Accessories for cable entry system page 674



Multigates and module plates page 676



Cable feed-throughs page 678 Plug assembly frames page 679



Cable glands page 680



Ex cable glands page 697



Service interfaces page 704

Plug-in charging connector systems - PLUSCON power



DC charging cables page 716



AC charging cables page 718



Mobile AC charging cables page 722



Infrastructure Socket Outlets page 726



Connectors

PLUSCON circular is the range of circular connectors for use in industrial automation. The sizes available range from M5, M8, and M12 through M17 and M23 to M40 and M58 connectors. The latter are used exclusively to transmit electrical power up to 150 A at 630 V per contact feed-through. The complete range covers the entire scope of circular connectors for industrial applications.

Sensor/actuator connectors

Safe and efficient assembly is of utmost importance in field wiring. You can choose from all connection technologies, enabling you to precisely adapt to the relevant application or requirements in the field. The connectors for assembly are available in various versions, unshielded and EMC-compliant.

Sensor/actuator device connectors

A comprehensive range of device connectors and panel feed-throughs has emerged as a result of the various requirements for device connection technology in industrial environments. Customer-specific developments enable optimum adaptation to individual device concepts.

Signal, feedback, hybrid, and power connectors

The product portfolio for M17 to M58 connectors covers all common applications in industrial environments for signal, hybrid, and power plug-in connections up to 630 V/150 A. This also includes requirements relating to tightness of seal, vibration resistance, and shielding against EMI. The circular connector range is rounded off with a complete portfolio of plastic molded connectors.

Sensor/actuator connectors

M8 connectors	14
M12 connectors	17
7/8" connectors	24
Valve connectors	26

Sensor/actuator device connectors

M5 device connectors	30
M8 device connectors	31
M12 device connectors	33
7/8" device connectors	49
Accessories	52

Signal connectors

M17 signal connectors	58
M23 signal connectors	74

Feedback connectors

M23 feedback connectors	88
-------------------------	----

Hybrid connectors

M23 hybrid connectors	100
-----------------------	-----

Power connectors

M17 power connectors	110
M23 power connectors	126
M40 power connectors	138
M58 power connectors	148

Tools and accessories	156
-----------------------	-----

Connectors

M8 sensor/actuator connectors

M8, solder connection



Unshielded,
3-, 4-pos.



Shielded,
3-, 4-pos.

ERC

ERC

	Technical data			
	3-pos.	4-pos.		
General data				
M8 circular connector according to:	IEC 61076-2-104			
Pollution degree	3			
Degree of protection	IP67			
Connection method	Solder connection			
Cable diameter	3.5 mm ... 5 mm			
Connection cross section [mm ²]	0.08 mm ² ... 0.25 mm ²			
Electrical data				
Rated voltage	60 V	30 V		
Rated current	4 A			
Insulation resistance	≥ 100 MΩ			
Material data				
Material contact/contact surface	CuZn / Au			
Contact carrier material	PA			
Inflammability class according to UL 94	HB			
Temperature data				
Plug/socket	-40 ... 85 [°C]			
	Ordering data			
Description	Order No.	Pcs. / Pkt.	Order No.	Pcs. / Pkt.
	3-pos.		4-pos.	
Connectors				
Socket, angled	1529399	1	1513444	1
Plug, angled	1699902	1	1554209	1
Socket, straight	1681172	1	1681185	1
Plug, straight	1681156	1	1681169	1
	Accessories			
Pressure screw and seal, for cable diameters:				
2.5 mm ... 3.5 mm	SACC-M 8-SET/2,2-3,5	1436945		5

	Technical data			
	3-pos.	4-pos.		
General data				
M8 circular connector according to:	IEC 61076-2-104			
Pollution degree	3			
Degree of protection	IP67			
Connection method	Solder connection			
Cable diameter	3.5 mm ... 5 mm			
Connection cross section [mm ²]	0.08 mm ² ... 0.25 mm ²			
Electrical data				
Rated voltage	60 V	30 V		
Rated current	4 A			
Insulation resistance	≥ 100 MΩ			
Material data				
Material contact/contact surface	CuZn / Au			
Contact carrier material	PA			
Inflammability class according to UL 94	HB			
Temperature data				
Plug/socket	-40 ... 85			
	Ordering data			
Description	Order No.	Pcs. / Pkt.	Order No.	Pcs. / Pkt.
	3-pos.		4-pos.	
Connectors				
Socket, angled	1436479	1	1436482	1
Plug, angled	1436453	1	1436466	1
Socket, straight	1506927	1	1506930	1
Plug, straight	1506901	1	1506914	1
	Accessories			
Pressure screw and seal, for cable diameters:				
2.5 mm ... 3.5 mm				

M8, insulation displacement connection



0.08 mm² - 0.25 mm²,
3-, 4-pos.



0.25 mm² - 0.5 mm²,
3-, 4-pos.



	Technical data	
	3-pos.	4-pos.
General data		
M8 circular connector according to:	IEC 61076-2-104	
Pollution degree	3	
Degree of protection	IP65/IP67	
Connection method	Insulation displacement connection	
Cable diameter	2.5 mm ... 5 mm ±0.2 mm	
Electrical data		
Rated voltage	60 V	30 V
Rated current	4 A	
Insulation resistance	≥ 100 MΩ	
Material data		
Material contact/contact surface	CuSn / Ni/Au	
Contact carrier material	TPU GF	
Inflammability class according to UL 94	HB	
Temperature data		
Plug/socket	-25 ... 80 [°C]	



	Technical data	
	3-pos.	4-pos.
General data		
M8 circular connector according to:	IEC 61076-2-104	
Pollution degree	3	
Degree of protection	IP65/IP67	
Connection method	Insulation displacement connection	
Cable diameter	2.5 mm ... 5 mm ±0.2 mm	
Electrical data		
Rated voltage	60 V	30 V
Rated current	4 A	
Insulation resistance	≥ 100 MΩ	
Material data		
Material contact/contact surface	CuSn / Ni/Au	
Contact carrier material	TPU GF	
Inflammability class according to UL 94	HB	
Temperature data		
Plug/socket	-25 ... 80	

Description	Ordering data			
	Order No.	Pcs. / Pkt.	Order No.	Pcs. / Pkt.
	3-pos.		4-pos.	
Connectors				
Socket, straight	1441040	1	1441053	1
Plug, straight	1441008	1	1441011	1

Description	Ordering data			
	Order No.	Pcs. / Pkt.	Order No.	Pcs. / Pkt.
	3-pos.		4-pos.	
Connectors				
Socket, straight	1441066	1	1441079	1
Plug, straight	1441024	1	1441037	1

Connectors

M8 sensor/actuator connectors

M8, screw connection



Unshielded,
3-, 4-pos.



Shielded,
3-, 4-pos.

ERC

Technical data

General data		
M8 circular connector according to:	IEC 61076-2-104	
Pollution degree	3	
Degree of protection	IP67	
Connection method	Screw connection	
Cable diameter	3.5 mm ... 5 mm	
Connection cross section [mm ²]	0.14 mm ² ... 0.5 mm ²	
Electrical data		
Rated voltage	60 V	30 V
Rated current	4 A	
Insulation resistance	≥ 100 MΩ	
Material data		
Material contact/contact surface	CuZn / Au	
Contact carrier material	PA	
Inflammability class according to UL 94	HB	
Temperature data		
Plug/socket	-40 ... 85 [°C]	

Ordering data

Description	Order No.	Pcs. / Pkt.	Order No.	Pcs. / Pkt.
	3-pos.		4-pos.	
Connectors				
Socket, straight	1506888	1	1506891	1
Plug, straight	1501252	1	1501265	1
Socket, angled	1407582	1	1407584	1
Plug, angled	1407583	1	1407585	1

Accessories

Pressure screw and seal, for cable diameters:		
2.5 mm ... 3.5 mm	SACC-M 8-SET/2,2-3,5	1436945 5

ERC

Technical data

General data		
M8 circular connector according to:	IEC 61076-2-104	
Pollution degree	3	
Degree of protection	IP67	
Connection method	Screw connection	
Cable diameter	3.5 mm ... 5.5 mm	
Connection cross section [mm ²]	0.14 mm ² ... 0.5 mm ²	
Electrical data		
Rated voltage	60 V	30 V
Rated current	4 A	
Insulation resistance	≥ 100 MΩ	
Material data		
Material contact/contact surface	CuZn / Au	
Contact carrier material	PA	
Inflammability class according to UL 94	HB	
Temperature data		
Plug/socket	-40 ... 85 [°C]	

Ordering data

Description	Order No.	Pcs. / Pkt.	Order No.	Pcs. / Pkt.
	3-pos.		4-pos.	
Connectors				
Socket, straight	1542907	1	1542910	1
Plug, straight	1542884	1	1542897	1

Accessories

Pressure screw and seal, for cable diameters:		
2.5 mm ... 3.5 mm	SACC-M 8-SET/2,2-3,5	1436945 5

**M12, solder and Piercecon®
connection**

**Solder connection,
12-pos.**

**Piercecon® connection,
12, 17-pos.**

ERC

	Technical data	
	Unshielded	Shielded
General data		
M12 circular connector according to:	IEC 61076-2-101	
Pollution degree	3	
Degree of protection	IP67	
Connection method	Solder connection	
Cable diameter	6 mm ... 8 mm	
Connection cross section [mm ²]	0.08 mm ² ... 0.25 mm ²	
Electrical data		
Rated voltage	30 V	
Rated current	1 A	
Insulation resistance	> 10 GΩ	
Material data		
Material contact/contact surface	CuZn / Au	
Contact carrier material	PA	
Inflammability class according to UL 94	HB	
Temperature data		
Plug/socket	-40 ... 85	

ERC

	Technical data	
	12-pos.	17-pos.
General data		
M12 circular connector according to:	IEC 61076-2-101	
Pollution degree	3	
Degree of protection	IP67	
Connection method	Piercecon® fast connection	
Cable diameter	5.4 mm ... 8.2 mm	
Connection cross section [mm ²]	0.14 mm ²	
Electrical data		
Rated voltage	30 V	
Rated current	1.5 A	
Insulation resistance	≥ 100 MΩ	
Material data		
Material contact/contact surface	CuZn / Ni/Au	
Contact carrier material	PA	
Inflammability class according to UL 94	V0	
Temperature data		
Plug/socket	-25 ... 85	

Description	Coding	Ordering data			
		Unshielded		shielded	
		Order No.	Pcs. / Pkt.	Order No.	Pcs. / Pkt.
Connectors					
Socket, straight	A - standard	1404420	1	1404411	1
Plug, straight	A - standard	1404419	1	1404410	1
Socket, angled	A - standard	1404423	1	1404413	1
Plug, angled	A - standard	1404421	1	1404412	1

Description	Coding	Ordering data			
		12-pos.		17-pos.	
		Order No.	Pcs. / Pkt.	Order No.	Pcs. / Pkt.
Connectors					
Socket, straight	A - standard	1559631	1	1559644	1
Plug, straight	A - standard	1559592	1	1559602	1

M12 sensor/actuator connectors

M12, insulation displacement connection

new

Notes:

M12 connectors for assembly for networks and fieldbuses can be found in the data connectors and cables section from page 319



unshielded,
4-pos.



shielded, 0.14 mm² ... 0.75 mm²,
4, 5-pos.



	Technical data		Technical data		
	0.14 mm ² ... 0.34 mm ²	0.34 mm ² ... 0.75 mm ²	4-pos.	5-pos.	
General data	IEC 61076-2-101		IEC 61076-2-101		
M12 circular connector according to:	3		3		
Pollution degree	IP65/IP67		IP65/IP67		
Degree of protection	Insulation displacement connection		Insulation displacement connection		
Connection method	3.5 mm ... 6 mm	4 mm ... 8 mm	5 mm ... 9.7 mm		
Cable diameter	125 V	250 V	250 V AC/DC	60 V AC/DC	
Electrical data	4 A		4 A		
Rated voltage	≥ 100 MΩ		≥ 100 MΩ		
Rated current	CuSn / Ni/Au		CuSn / Ni/Au		
Insulation resistance	TPU		PA		
Material data	V0		V0		
Material contact/contact surface	-25 ... 80		-40 ... 85		
Contact carrier material					
Inflammability class according to UL 94					
Temperature data					
Plug/socket	[°C]				
Description	Coding	Ordering data		Ordering data	
		Order No.	Pcs. / Pkt.	Order No.	Pcs. / Pkt.
Connector , with plastic knurl		0.14 mm² ... 0.34 mm²	0.34 mm² ... 0.75 mm²	4-pos.	5-pos.
Socket, straight	A - standard	1641701	1	1641756	1
Plug, straight	A - standard	1641714	1	1641769	1
Connector , with metal knurl, SPEEDCON					
Socket, straight	A - standard	1521588	1	1521601	1
Plug, straight	A - standard	1521575	1	1521591	1
				1413994	1
				1413993	1
				1413992	1
				1413991	1
Connector , with metal knurl					
Socket, straight	A - standard	1641688	1	1641772	1
Plug, straight	A - standard	1641691	1	1641785	1
Connector , with stainless steel knurl					
Socket, straight	A - standard	1440766	1	1440782	1
Plug, straight	A - standard	1440753	1	1440779	1
Cable connector , shielded, color-coded terminal blocks, cable diameter: 5.0 mm ... 10.0 mm				1414418	1
				1414417	1

M12, spring connection

Notes:

M12 connectors for assembly for networks and fieldbuses can be found in the data connectors and cables section from page 319



Unshielded,
4-, 5-pos.



Shielded,
4-, 5-pos.



	Technical data	
	4-pos.	5-pos.
General data		
M12 circular connector according to:	IEC 61076-2-101	
Pollution degree	3	
Degree of protection	IP65/IP67	
Connection method	Spring connection	
Cable diameter	4 mm ... 8 mm	
Connection cross section [mm ²]	0.14 mm ² ... 0.5 mm ²	
Electrical data		
Rated voltage	250 V	60 V
Rated current	4 A	
Insulation resistance	≥ 100 MΩ	
Material data		
Material contact/contact surface	CuSn / Ni/Au	
Contact carrier material	TPU	
Inflammability class according to UL 94	V0	
Temperature data		
Plug/socket	-40 ... 85 [°C]	



	Technical data	
	4-pos.	5-pos.
General data		
M12 circular connector according to:	IEC 61076-2-101	
Pollution degree	3	
Degree of protection	IP65/IP67	
Connection method	Spring connection	
Cable diameter	4 mm ... 8 mm	
Connection cross section [mm ²]	0.14 mm ² ... 0.5 mm ²	
Electrical data		
Rated voltage	60 V DC	
Rated current	4 A	
Insulation resistance	≥ 100 MΩ	
Material data		
Material contact/contact surface	CuSn / Ni/Au	
Contact carrier material	TPU	
Inflammability class according to UL 94	V0	
Temperature data		
Plug/socket	-40 ... 85	

Description	Coding	Ordering data			
		4-pos.		5-pos.	
		Order No.	Pcs. / Pkt.	Order No.	Pcs. / Pkt.
Connector , terminal marking: standard color coding and numbering					
Socket, angled	A - standard	1432622	1	1432596	1
Plug, angled	A - standard	1432606	1	1432570	1
Socket, straight	A - standard	1432619	1	1432583	1
Plug, straight	A - standard	1432635	1	1432567	1

Description	Coding	Ordering data			
		4-pos.		5-pos.	
		Order No.	Pcs. / Pkt.	Order No.	Pcs. / Pkt.
Connector , terminal marking: standard color coding and numbering					
Socket, angled	A - standard	1432758	1	1432677	1
Plug, angled	A - standard	1432732	1	1432651	1
Socket, straight	A - standard	1432745	1	1432664	1
Plug, straight	A - standard	1432729	1	1432648	1

Connectors

M12 sensor/actuator connectors

M12, screw connection

Notes:
M12 connectors for assembly for networks and fieldbuses can be found in the data connectors and cables section from page 319



Plastic knurl,
4, 5-pos.



Metal knurl, SPEEDCON,
4, 5-pos.



Technical data	
4-pos.	5-pos.
General data	
M12 circular connector according to:	
Pollution degree	
Degree of protection	
Connection method	
Connection cross section [mm ²]	
Electrical data	
Rated voltage	250 V
Rated current	4 A
Insulation resistance	≥ 100 MΩ
Material data	
Material contact/contact surface	
Contact carrier material	
Inflammability class according to UL 94	
Temperature data	
Plug/socket	[°C]

Technical data	
4-pos.	5-pos.
IEC 61076-2-101	
3	
IP67	
Screw connection	
0.25 mm ² ... 0.75 mm ²	
250 V	60 V
4 A	
≥ 100 MΩ	
CuZn / CuSnZn	
PA	
HB	
-40 ... 85	

Technical data	
4-pos.	5-pos.
IEC 61076-2-101	
3	
IP67	
Screw connection	
0.25 mm ² ... 0.75 mm ²	
250 V	60 V
4 A	
≥ 100 MΩ	
CuZn / CuSnZn	
PA	
HB	
-40 ... 85	

Description	Coding
Connector, cable diameter: 4 mm ... 6 mm	
Socket, angled	A - standard
Plug, angled	A - standard
Socket, straight	A - standard
Plug, straight	A - standard
Connector, cable diameter: 6 mm ... 8 mm	
Socket, angled	A - standard
Plug, angled	A - standard
Socket, straight	A - standard
Plug, straight	A - standard
Connector, cable diameter: 8 mm ... 10 mm	
Socket, straight	A - standard
Plug, straight	A - standard
Power connector, cable diameter: 8 mm ... 10 mm, rated current: up to 8 A (5th pos. max. 2 A) with 1.5 mm² wires/litz wires	
Socket, angled	A - standard
Plug, angled	A - standard
Socket, straight	A - standard
Plug, straight	A - standard

Ordering data					
Order No.	Pcs. / Pkt.	Order No.	Pcs. / Pkt.	Order No.	Pcs. / Pkt.
4-pos.		5-pos.			
1681130	1	1662308	1		
1681091	1	1662269	1		
1681114	1	1662298	1		
1681088	1	1662256	1		
		1500790	1		
		1513431	1		
		1500787	1		
		1500774	1		

Ordering data					
Order No.	Pcs. / Pkt.	Order No.	Pcs. / Pkt.	Order No.	Pcs. / Pkt.
4-pos.		5-pos.			
1543058	1	1543061	1		
1542981	1	1542994	1		
1543029	1	1543032	1		
1542952	1	1542965	1		
		1543414	1		
		1543003	1		
		1543045	1		
		1542978	1		

Accessories	
Pressure screw and seal, for cable diameters:	
2.5 mm ... 3.5 mm	

Accessories		
SACC-M12-SET/2,5-3,5	1436505	5

Accessories		
SACC-M12-SET/2,5-3,5	1436505	5



Metal knurl,
4, 5, 8-pos.



Metal knurl,
4, 5-pos.,
with SKINTOP® screw connection



Stainless steel knurl,
4, 5-pos.



Technical data		
4-pos.	5-pos.	8-pos.
IEC 61076-2-101		
3		
IP67		
Screw connection		
0.25 mm ² ... 0.75 mm ²	0.25 mm ² ... 0.5 mm ²	
250 V	60 V	30 V
4 A	2 A	
≥ 100 MΩ		
CuZn / CuSnZn		CuZn / Au
PA		
HB		
-40 ... 85		

Technical data		
4-pos.	5-pos.	
IEC 61076-2-101		
3		
IP67		
Screw connection		
0.25 mm ² ... 0.75 mm ²		
250 V	60 V	
4 A		
≥ 100 MΩ		
CuZn / CuSnZn		
PA		
HB		
-20 ... 80		

Technical data		
4-pos.	5-pos.	
IEC 61076-2-101		
3		
IP65/IP67/IP69K		
Screw connection		
0.25 mm ² ... 0.75 mm ²		
250 V	60 V	
4 A		
≥ 100 MΩ		
CuZn / Au		
PA		
V0		
-40 ... 85		

Ordering data					
Order No.	Pcs. / Pkt.	Order No.	Pcs. / Pkt.	Order No.	Pcs. / Pkt.
4-pos.		5-pos.		8-pos.	
1681143	1	1662984	1		
1681101	1	1663129	1		
1681127	1	1662968	1		
1662528	1	1663116	1		
		1681499	1		
		1681473	1		
1696439	1	1681486	1	1513347	1
1523230	1	1681460	1	1513334	1

Ordering data					
Order No.	Pcs. / Pkt.	Order No.	Pcs. / Pkt.	Order No.	Pcs. / Pkt.
4-pos.		5-pos.			
1430381	1	1559000	1		
1556870	1	1456466	1		
		1556812	1		
		1561742	1		
		1556838	1		
		1556825	1		

Ordering data					
Order No.	Pcs. / Pkt.	Order No.	Pcs. / Pkt.	Order No.	Pcs. / Pkt.
4-pos.		5-pos.			
1553284	1	1553297	1		
1553200	1	1553213	1		
1553242	1	1553255	1		
1553161	1	1553187	1		
		1553307	1		
1553226	1	1553239	1		
1553268	1	1553271	1		
1553174	1	1553190	1		

		1410665	1		
		1410666	1		
1408991	1	1408993	1		
1408990	1	1408992	1		
1404416	1	1404418	1		
1404415	1	1404417	1		

Accessories		
SACC-M12-SET/2,5-3,5	1436505	5

Accessories		

Accessories		
SACC-M12-SET/2,5-3,5	1436505	5

Connectors

M12 sensor/actuator connectors

M12, screw connection, shielded



Cast zinc housing,
4, 5, 8-pos.



Stainless steel housing,
5-pos.



	Technical data						Technical data						
	4-pos.		5-pos.		8-pos.		5-pos.						
General data													
M12 circular connector according to:	IEC 61076-2-101						IEC 61076-2-101						
Pollution degree	3						3						
Degree of protection	IP67						IP65/IP67/IP69K						
Connection method	Screw connection						Screw connection						
Connection cross section [mm ²]	0.25 mm ² ... 0.75 mm ²		0.25 mm ² ... 0.5 mm ²		0.25 mm ² ... 0.5 mm ²		0.25 mm ² ... 0.75 mm ²						
Electrical data													
Rated voltage	60 V DC		30 V		30 V		60 V DC						
Rated current	4 A		2 A		2 A		4 A						
Insulation resistance	≥ 100 MΩ						≥ 100 MΩ						
Material data													
Material contact/contact surface	CuZn / Au						CuZn / Au						
Contact carrier material	PA						PA						
Inflammability class according to UL 94	HB						V0						
Temperature data													
Plug/socket	[°C]		-40 ... 85		-40 ... 85		-40 ... 85						
Ordering data													
Description	Coding	4-pos.		5-pos.		8-pos.		5-pos.					
		Order No.	Pcs. / Pkt.	Order No.	Pcs. / Pkt.	Order No.	Pcs. / Pkt.	Order No.	Pcs. / Pkt.	Order No.	Pcs. / Pkt.	Order No.	Pcs. / Pkt.
Connector, cable diameter: 4 mm ... 6 mm													
Plug, angled	A - standard	1694279	1	1693429	1								
Socket, straight	A - standard	1694295	1	1694305	1								
Plug, straight	A - standard	1693830	1	1693416	1								
Connector, cable diameter: 6 mm ... 8 mm													
Socket, angled	A - standard			1430433	1								
Plug, angled	A - standard			1694282	1								
Socket, straight	A - standard	1515170	1	1694318	1	1511860	1						
Plug, straight	A - standard	1501540	1	1694266	1	1511857	1						
Connector, cable diameter: 6 mm ... 8.5 mm													
Socket, straight	A - standard			1508365	1								
Plug, straight	A - standard			1508352	1								
Connector, cable diameter: 3 mm ... 5.5 mm													
Socket, straight	A - standard							1440038	1				
Plug, straight	A - standard							1440012	1				
Connector, cable diameter: 5.5 mm ... 8.6 mm													
Socket, straight	A - standard							1440041	1				
Plug, straight	A - standard							1440025	1				

M12, DUO connector, screw connection

Notes:
SPEEDCON and plastic knurls without key areas.



Metal knurl, 4-, 5-pos.



Plastic and stainless steel knurl, 5-pos.



	Technical data	
	4-pos.	5-pos.
General data	IEC 61076-2-101	
M12 circular connector according to:	3	
Pollution degree	IP67	
Degree of protection	Screw connection	
Connection method	2x 2.1 mm ... 3 mm	
Cable diameter	(when using the seal for small outer cable diameters)	
	2x 4 mm ... 5.2 mm	
	(when using the seal for large outer cable diameters)	
	0.25 mm ² ... 0.75 mm ²	
Electrical data		
Rated voltage	250 V	60 V
Rated current	4 A	
Insulation resistance	≥ 100 MΩ	
Material data		
Material contact/contact surface	CuZn / CuSnZn	
Contact carrier material	PA	
Inflammability class according to UL 94	V0	
Temperature data		
Plug/socket	-40 ... 85 [°C]	



	Technical data	
	Plastic knurl	Stainless steel knurl
General data	IEC 61076-2-101	
M12 circular connector according to:	3	
Pollution degree	IP67	
Degree of protection	Screw connection	
Connection method	2x 2.1 mm ... 3 mm	
Cable diameter	(when using the seal for small outer cable diameters)	
	2x 4 mm ... 5.2 mm	
	(when using the seal for large outer cable diameters)	
	0.25 mm ² ... 0.75 mm ²	
Electrical data		
Rated voltage	60 V	
Rated current	4 A	
Insulation resistance	≥ 100 MΩ	
Material data		
Material contact/contact surface	CuZn / CuSnZn	CuZn / Au
Contact carrier material	PA	
Inflammability class according to UL 94	V0	
Temperature data		
Plug/socket	-40 ... 85	

Description	Coding	Ordering data			
		4-pos.		5-pos.	
		Order No.	Pcs. / Pkt.	Order No.	Pcs. / Pkt.
Connector, with metal knurl, for connecting two cables					
Plug, straight	A - standard	1507052	1	1662748	1
Connector, with metal knurl, SPEEDCON, for connecting two cables					
Plug, straight	A - standard			1543016	1
Connector, with plastic knurl, for connecting two cables					
Socket, straight	A - standard				
Plug, straight	A - standard				
Plug, angled	A - standard				
Connector, with stainless steel knurl, for connecting two cables					
Socket, straight	A - standard				
Plug, straight	A - standard				

Description	Coding	Ordering data			
		Plastic knurl		Stainless steel knurl	
		Order No.	Pcs. / Pkt.	Order No.	Pcs. / Pkt.
Connector, with plastic knurl, for connecting two cables					
Socket, straight	A - standard	1694596	1		
Plug, straight	A - standard	1662285	1		
Plug, angled	A - standard	1531044	1		
Connector, with stainless steel knurl, for connecting two cables					
Socket, straight	A - standard			1403372	1
Plug, straight	A - standard			1403371	1

Connectors

7/8" sensor/actuator connectors

7/8", screw connection



Connection cross section:
1.5 mm², 3-, 4-, 5-pos.



Connection cross section:
2.5 mm², 5-pos.



	Technical data		
	3-pos.	4-pos.	5-pos.
General data			
Pollution degree		3	
Degree of protection		IP67	
Connection method		Screw connection	
Connection cross section		0.34 mm ² ... 1.5 mm ²	
Connection cross section AWG		22 ... 16	
Electrical data			
Rated voltage		300 V	
Rated current	12 A		9 A
Insulation resistance		≥ 100 MΩ	
Material data			
Material contact/contact surface		CuZn / Au	
Contact carrier material		PUR / PA66	
Inflammability class according to UL 94		HB	
Temperature data			
Plug/socket		-25 ... 85	



	Technical data		
	5-pos.		
General data			
Pollution degree		3	
Degree of protection		IP67	
Connection method		Screw connection	
Connection cross section		0.34 mm ² ... 2.5 mm ²	
Connection cross section AWG		22 ... 14	
Electrical data			
Rated voltage		300 V	
Rated current		9 A	
Insulation resistance		≥ 100 MΩ	
Material data			
Material contact/contact surface		CuZn / Au	
Contact carrier material		PUR / PA66	
Inflammability class according to UL 94		HB	
Temperature data			
Plug/socket		-25 ... 85	

	Ordering data					
	Order No.	Pcs. / Pkt.	Order No.	Pcs. / Pkt.	Order No.	Pcs. / Pkt.
Description						
Connector, cable diameter: 6 mm ... 8 mm						
Socket, angled	1521478	1	1521494	1	1521517	1
Plug, angled	1521465	1	1521481	1	1521504	1
Socket, straight	1521300	1	1521342	1	1521384	1
Plug, straight	1521287	1	1521326	1	1521668	1
Connector, cable diameter: 8 mm ... 10 mm						
Socket, angled						
Plug, angled						
Socket, straight						
Plug, straight						
Connector, cable diameter: 10 mm ... 12 mm						
Socket, angled						
Plug, angled						
Socket, straight	1521313	1	1521355	1	1521397	1
Plug, straight	1521290	1	1521339	1	1521371	1
Connector, cable diameter: 12 mm ... 14 mm						
Socket, straight					1559071	1
Plug, straight					1559039	1

	Ordering data					
	Order No.	Pcs. / Pkt.	Order No.	Pcs. / Pkt.	Order No.	Pcs. / Pkt.
Description						
Connector, cable diameter: 6 mm ... 8 mm						
Socket, angled						
Plug, angled						
Socket, straight						
Plug, straight						
Connector, cable diameter: 8 mm ... 10 mm						
Socket, angled	1456297	1				
Plug, angled	1456242	1				
Socket, straight	1456271	1				
Plug, straight	1456226	1				
Connector, cable diameter: 10 mm ... 12 mm						
Socket, angled						
Plug, angled						
Socket, straight						
Plug, straight						
Connector, cable diameter: 12 mm ... 14 mm						
Socket, straight						
Plug, straight						

Connectors

Valve connectors

Valve connectors, type A, screw connection



Without protective circuit



Protective circuit: varistor

ERC

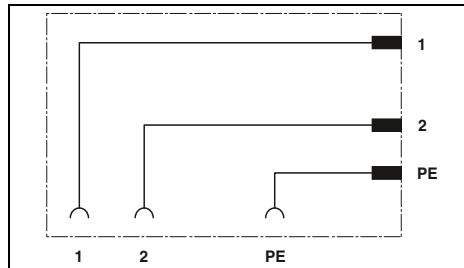

ERC

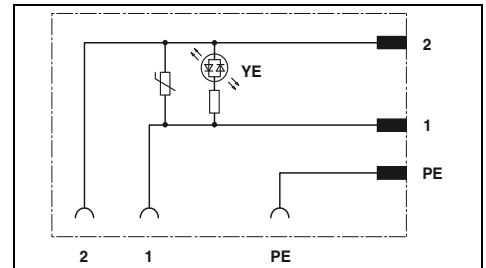

Technical data

General data	
Valve connector according to:	EN 175301-803
Pollution degree	3
Degree of protection	IP65
Connection method	Screw connection
Electrical data	
Rated current	10 A
Insulation resistance	> 2 GΩ
Material data	
Material contact valve connector	CuZn
Material contact surface valve connector	CuSn
Inflammability class according to UL 94	HB
Temperature data	
Valve connectors	[-25 ... 60] [°C]

Technical data	
EN 175301-803	
3	
IP65	
Screw connection	
Electrical data	
1.5 A	
> 2 GΩ	
Material data	
CuZn	
CuSn	
HB	
Temperature data	
-25 ... 60	

Ordering data

Description	
Valve connector , without protective circuit, rated voltage: 230 V	
3-pos.	
4-pos.	
Valve connector , with protective circuit, rated voltage:	
24 V	
110 V	
230 V	
Valve connector , 5-pos., type A, for pressure switch, 2 LEDs, without protective circuit, M16 cable gland, rated voltage: 24 V	
Valve connector , with protective circuit, rated voltage: 24 V, cable gland:	
Pg9	
M16	

Type	Order No.	Pcs. / Pkt.
SACC-VB-3CON-M16/A	1452123	1
SACC-VB-4CON-M16/A	1452136	1

Technical data

General data	
Valve connector according to:	EN 175301-803
Pollution degree	3
Degree of protection	IP65
Connection method	Screw connection
Electrical data	
Rated current	1.5 A
Insulation resistance	> 2 GΩ
Material data	
Material contact valve connector	CuZn
Material contact surface valve connector	CuSn
Inflammability class according to UL 94	HB
Temperature data	
Valve connectors	[-25 ... 60] [°C]

Type	Order No.	Pcs. / Pkt.
SACC-VB-3CON-M16/A-1L-SV 24V	1452149	1
SACC-VB-3CON-M16/A-1L-SV 110V	1452152	1
SACC-VB-3CON-M16/A-1L-SV 230V	1452165	1



Protective circuit: varistor and rectifier



Pressure switch



Protective circuit: Z diode

ERC

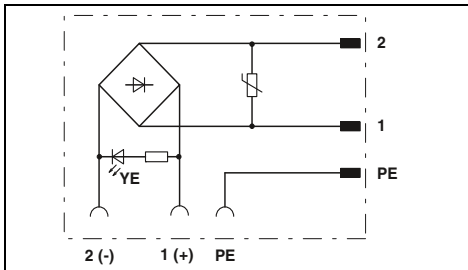

Technical data

EN 175301-803
3
IP65
Screw connection

1.5 A
> 2 GΩ

CuZn
CuSn
HB

-25 ... 60

Ordering data

Type	Order No.	Pcs. / Pkt.
SACC-VB-3CON-M16/A-GVL 12/24V	1452178	1
SACC-VB-3CON-M16/A-GVL 110V	1452181	1
SACC-VB-3CON-M16/A-GVL 230V	1452194	1

ERC

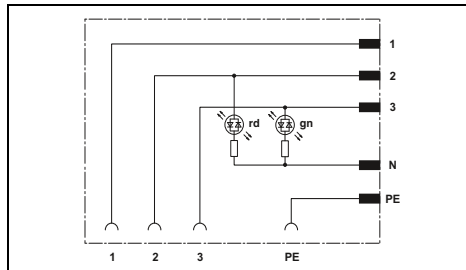

Technical data

EN 175301-803
3
IP65
Screw connection

1.5 A
> 2 GΩ

CuZn
CuSn
HB

-25 ... 60

Ordering data

Type	Order No.	Pcs. / Pkt.
SACC-VB-5CON-M16/AD-2L 24V	1457908	1

ERC

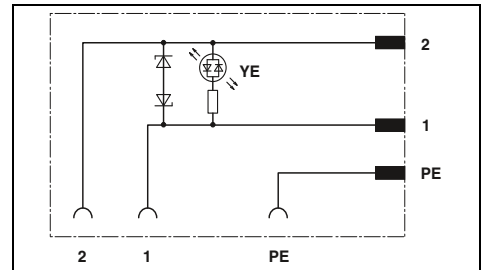

Technical data

EN 175301-803
3
IP65
Screw connection

4 A
> 2 GΩ

CuSn
Ag
HB

-25 ... 60

Ordering data

Type	Order No.	Pcs. / Pkt.
SACC-V-3CON-PG9/A-1L-S	1671137	1
SACC-V-3CON-M16/A-1L-S	1544714	1

Connectors

Valve connectors

Valve connectors, types B and BI, screw connection



Protective circuit: Z diode



Protective circuit: varistor

ERC

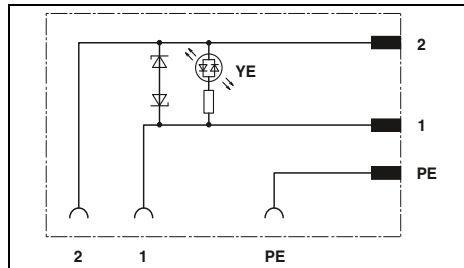

ERC

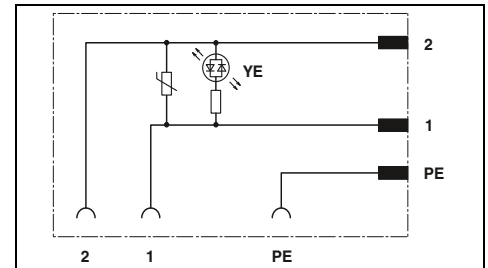

Technical data

Type B	Type BI
EN 175301-803	-
3	-
IP65	-
Screw connection	-
24 V	-
4 A	-
> 2 GΩ	-
Ag	-
PA	-
HB	-
-25 ... 60	-

Technical data

Type B	Type BI
EN 175301-803	-
3	-
IP65	-
Screw connection	-
24 V	-
1.5 A	-
> 2 GΩ	-
CuSn	-
PA	-
HB	-
-25 ... 60	-

General data	
Valve connector according to:	
Pollution degree	
Degree of protection	
Connection method	
Electrical data	
Rated voltage	
Rated current	
Insulation resistance	
Material data	
Material contact surface valve connector	
Material housing valve connector	
Inflammability class according to UL 94	
Temperature data	
Valve connectors	[°C]

Ordering data

Order No.	Pcs. / Pkt.	Order No.	Pcs. / Pkt.
Type B		Type BI	
1671153	1	1671140	1

Ordering data

Order No.	Pcs. / Pkt.	Order No.	Pcs. / Pkt.
Type B		Type BI	
1452204	1	1452233	1
1452217	1	1452246	1
1452220	1	1452259	1

Description	
Valve plug, 3-pos., with protective circuit, Pg9 cable gland	
Valve plug, with protective circuit, yellow LED, rated voltage:	
24 V	
110 V	
230 V	

Valve connectors, type C and CI, screw connection



Protective circuit: varistor

ERC

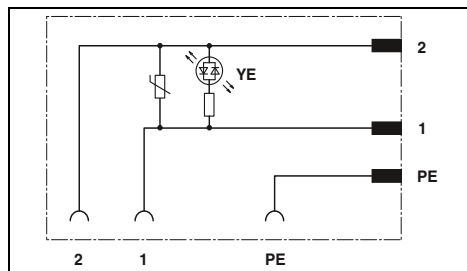

Technical data

General data	Type C	Type CI
	Valve connector according to:	EN 175301-803
Pollution degree		3
Degree of protection		IP65
Connection method	Screw connection	
Electrical data		
Rated current	1.5 A	
Insulation resistance	> 2 GΩ	
Material data		
Material contact valve connector	CuZn	
Material contact surface valve connector	CuSn	
Inflammability class according to UL 94	HB	
Temperature data		
Valve connectors [°C]	-25 ... 60	

Ordering data

Description	Order No.	Pcs. / Pkt.	Order No.	Pcs. / Pkt.
	Type C		Type CI	
Valve plug, with protective circuit, yellow LED, rated voltage:				
24 V	1452262	1	1452291	1
110 V	1452275	1	1452301	1
230 V	1452288	1	1452314	1

Connectors

M5 sensor/actuator device connectors, front mounting

M5, with 0.5 m long litz wires

Notes:
Flat nut recommended for housing wall thicknesses < 2.5 mm.



M5, 3, 5-pos.

ERC

Technical data

	3-pos.	4-pos.
General data		
M5 circular connector according to:	IEC 61076-2-105	IEC 61076-2-105
Pollution degree	3	3
Degree of protection	IP67	IP67
Connection method	Individual wires	Individual wires
Electrical data		
Rated voltage	60 V	60 V
Rated current	1 A	1 A
Material data		
Material contact/contact surface	CuSn / Au	CuSn / Au
Contact carrier material	PA 66	PA 66
Inflammability class according to UL 94	HB	HB
Cable type	TPE litz wire	TPE litz wire
Temperature data		
Plug/socket	-25 ... 85 [°C]	-25 ... 85

Ordering data

Description	Coding	3-pos.		4-pos.	
		Order No.	Pcs. / Pkt.	Order No.	Pcs. / Pkt.
Device connectors					
Socket	A - standard	1530605	1	1530618	1
Plug	A - standard	1530582	1	1530595	1

Accessories

Flat nut, with: M5 thread	SACC-E-MU-M 5	1535901	100
-------------------------------------	---------------	---------	-----

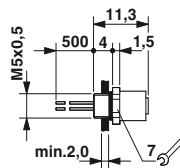

Dimensions: socket

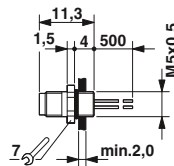

Dimensions: plug

M8 sensor/actuator device connectors, front mounting

M8, with 0.5 m long litz wires



M8, 3, 4, 5-pos.



M8, 6, 8-pos.



	Technical data		
	3-pos.	4-pos.	5-pos.
General data			
M8 circular connector according to:	IEC 61076-2-104	IEC 61076-2-104	IEC 61076-2-104
Pollution degree	3	3	3
Degree of protection	IP67	IP67	IP67
Connection method	Individual wires	Individual wires	Individual wires
Electrical data			
Rated voltage	60 V	30 V	30 V
Rated current	4 A	4 A	3 A
Material data			
Material contact/contact surface	Cu alloy / Au	Cu alloy / Au	Cu alloy / Au
Contact carrier material	PA 66	PA 66	PA 66
Inflammability class according to UL 94	HB	HB	HB
Cable type	TPE litz wire	TPE litz wire	PVC litz wire
Temperature data			
Plug/socket	-25 ... 85	-25 ... 85	-25 ... 85

	Technical data	
	6-pos.	8-pos.
General data		
M8 circular connector according to:	IEC 61076-2-104	IEC 61076-2-104
Pollution degree	3	3
Degree of protection	IP67	IP67
Connection method	Individual wires	Individual wires
Electrical data		
Rated voltage	30 V	30 V
Rated current	2 A	1.5 A
Material data		
Material contact/contact surface	Cu alloy / Au	Cu alloy / Au
Contact carrier material	PA 66	PA 66
Inflammability class according to UL 94	HB	HB
Cable type	TPE litz wire	PVC litz wire
Temperature data		
Plug/socket	-25 ... 85	-25 ... 85

Description	Coding	Ordering data					
		3-pos.		4-pos.		5-pos.	
		Order No.	Pcs. / Pkt.	Order No.	Pcs. / Pkt.	Order No.	Pcs. / Pkt.
Device connectors							
Socket	A - standard	1500350	1	1500363	1		
Plug	A - standard	1500334	1	1500347	1		
Socket	B - inverse					1424233	1
Plug	B - inverse					1424234	1
Flat nut, with:							
M8 thread		1504071	100	1504071	100		

Description	Coding	Ordering data			
		6-pos.		8-pos.	
		Order No.	Pcs. / Pkt.	Order No.	Pcs. / Pkt.
Socket	A - standard	1542677	1	1424231	1
Plug	A - standard	1542664	1	1424232	1
Socket	B - inverse				
Plug	B - inverse				
Flat nut, with:					
M8 thread		1504071	100		

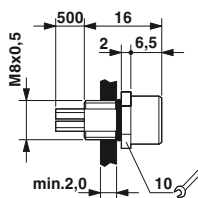

Dimensions: socket, 3, 4, 6-pos.

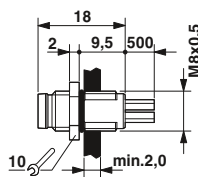

Dimensions: plug, 3, 4, 6-pos.

Connectors

M8 sensor/actuator device connectors, rear mounting

M8, with 0.5 m long litz wires



3-, 4-pos.



6, 8-pos.

us ERIC

ERIC

	Technical data			
	3-pos.		4-pos.	
General data				
M8 circular connector according to:	IEC 61076-2-104		IEC 61076-2-104	
Pollution degree	3		3	
Degree of protection	IP67		IP67	
Connection method	Individual wires		Individual wires	
Electrical data				
Rated voltage	60 V		30 V	
Rated current	4 A		4 A	
Material data				
Material contact/contact surface	Cu alloy / Au		Cu alloy / Au	
Contact carrier material	PUR / PA66		PUR / PA66	
Inflammability class according to UL 94	HB		HB	
Cable type	TPE litz wire		TPE litz wire	
Temperature data				
Plug/socket	-25 ... 85		-25 ... 85	

	Technical data			
	6-pos.		8-pos.	
General data				
M8 circular connector according to:	IEC 61076-2-104		IEC 61076-2-104	
Pollution degree	3		3	
Degree of protection	IP67		IP67	
Connection method	Individual wires		Individual wires	
Electrical data				
Rated voltage	30 V		30 V	
Rated current	2 A		1.5 A	
Material data				
Material contact/contact surface	Cu alloy / Au		Cu alloy / Au	
Contact carrier material	PUR / PA66		PUR / PA66	
Inflammability class according to UL 94	HB		HB	
Cable type	TPE litz wire		PVC litz wire	
Temperature data				
Plug/socket	-25 ... 85		-25 ... 85	

	Coding	Ordering data			
		Order No.	Pcs. / Pkt.	Order No.	Pcs. / Pkt.
Description		3-pos.		4-pos.	
Device connector, M8 fastening thread					
Plug	A - standard	1453478	1	1453481	1
Device connector, M10 fastening thread					
Socket	A - standard	1456080	1	1456093	1
Device connector, M12 fastening thread					
Socket	A - standard	1453449	1	1453452	1

	Coding	Ordering data			
		Order No.	Pcs. / Pkt.	Order No.	Pcs. / Pkt.
Description		6-pos.		8-pos.	
Device connector, M8 fastening thread					
Plug	A - standard	1453494	1	1424230	1
Device connector, M10 fastening thread					
Socket	A - standard	1456103	1	1424229	1
Device connector, M12 fastening thread					
Socket	A - standard	1453465	1		

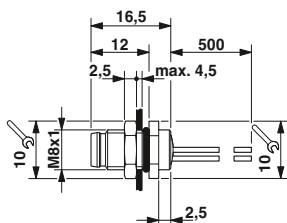

Dimensions: connector, M8 fastening thread

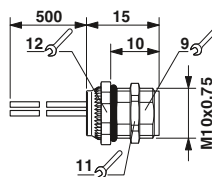

Dimensions: socket, M10 fastening thread

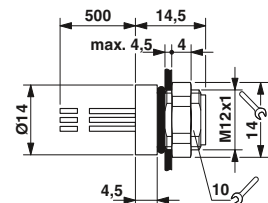

Dimensions: socket, M12 fastening thread

M12 sensor/actuator device connectors, front mounting

Pg9 fastening thread, with 0.5 m long litz wires



4-, 5-, 8-pos.



can be positioned, 4-, 5-, 8-pos.



	Technical data		
	4-pos.	5-pos.	8-pos.
General data			
M12 circular connector according to:	IEC 61076-2-101	IEC 61076-2-101	IEC 61076-2-101
Pollution degree	3	3	3
Degree of protection	IP67	IP67	IP67
Connection method	Individual wires	Individual wires	Individual wires
Electrical data			
Rated voltage	250 V	60 V	30 V
Rated current	4 A	4 A	2 A
Material data			
Material contact/contact surface	CuZn / NiAu	CuZn / NiAu	CuZn / NiAu
Contact carrier material	PA66	PA66	PA66
Inflammability class according to UL 94	V0	V0	V0
Cable type	TPE litz wire	TPE litz wire	TPE litz wire
Temperature data			
Plug/socket	-25 ... 85	-25 ... 85	-25 ... 85

	Ordering data					
	Order No.	Pcs. / Pkt.	Order No.	Pcs. / Pkt.	Order No.	Pcs. / Pkt.

Accessories		
Flat nut, with: Pg9 thread	SACC-E-MU-PG9	1504084 100



	Technical data		
	4-pos.	5-pos.	8-pos.
General data			
M12 circular connector according to:	IEC 61076-2-101	IEC 61076-2-101	IEC 61076-2-101
Pollution degree	3	3	3
Degree of protection	IP67	IP67	IP67
Connection method	Individual wires	Individual wires	Individual wires
Electrical data			
Rated voltage	250 V	60 V	30 V
Rated current	4 A	4 A	2 A
Material data			
Material contact/contact surface	CuZn / NiAu	CuZn / NiAu	CuZn / NiAu
Contact carrier material	PA66	PA66	PA66
Inflammability class according to UL 94	V0	V0	V0
Cable type	TPE litz wire	TPE litz wire	TPE litz wire
Temperature data			
Plug/socket	-25 ... 85	-25 ... 85	-25 ... 85

	Ordering data					
	Order No.	Pcs. / Pkt.	Order No.	Pcs. / Pkt.	Order No.	Pcs. / Pkt.

Accessories		
Flat nut, with: Pg9 thread		

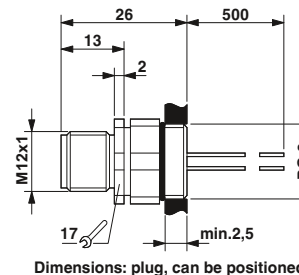
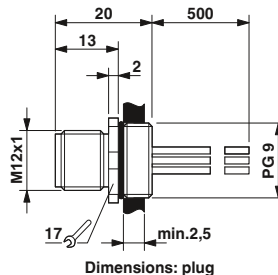
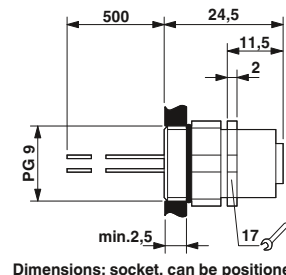
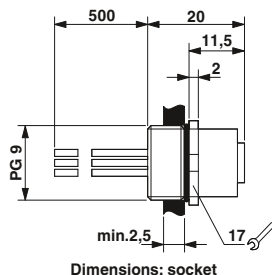

Connectors

M12 sensor/actuator device connectors, front mounting

M16 fastening thread, with 0.5 m long litz wires



4-, 5-, 8-pos.



12-, 17-pos.



	Technical data		
	4-pos.	5-pos.	8-pos.
General data			
M12 circular connector according to:	IEC 61076-2-101	IEC 61076-2-101	IEC 61076-2-101
Pollution degree	3	3	3
Degree of protection	IP65/IP67	IP65/IP67	IP65/IP67
Connection method	Individual wires	Individual wires	Individual wires
Electrical data			
Rated voltage	250 V	60 V	30 V
Rated current	4 A	4 A	2 A
Material data			
Material contact/contact surface	CuZn / Ni/Au	CuZn / Ni/Au	CuZn / Ni/Au
Contact carrier material	PA 66	PA 66	PA 66
Inflammability class according to UL 94	V0	V0	V0
Cable type	TPE litz wire	TPE litz wire	TPE litz wire
Temperature data			
Plug/socket	-25 ... 85	-25 ... 85	-25 ... 85



	Technical data	
	12-pos.	17-pos.
General data		
M12 circular connector according to:	IEC 61076-2-101	IEC 61076-2-101
Pollution degree	3	3
Degree of protection	IP65/IP67	IP65/IP67
Connection method	Individual wires	Individual wires
Electrical data		
Rated voltage	30 V	30 V
Rated current	1.5 A	1.5 A
Material data		
Material contact/contact surface	CuZn / Ni/Au	CuZn / Ni/Au
Contact carrier material	PA 66	PA 66
Inflammability class according to UL 94	V0	V0
Cable type	TPE litz wire	TPE litz wire
Temperature data		
Plug/socket	-25 ... 85	-25 ... 85

Description	Coding	Ordering data					
		4-pos.		5-pos.		8-pos.	
		Order No.	Pcs. / Pkt.	Order No.	Pcs. / Pkt.	Order No.	Pcs. / Pkt.
Device connectors							
Socket	A - standard	1523434	1	1520039	1	1523476	1
Plug	A - standard	1523450	1	1520055	1	1523492	1
Socket	D - data	1535202	1				
Plug	D - data	1551558	1				
Socket	B - inverse			1520000	1		
Plug	B - inverse			1520013	1		

Description	Coding	Ordering data					
		12-pos.		17-pos.			
		Order No.	Pcs. / Pkt.	Order No.	Pcs. / Pkt.	Order No.	Pcs. / Pkt.
Device connectors							
Socket	A - standard	1556252	1	1556294	1		
Plug	A - standard	1556265	1	1556304	1		

Accessories		
Flat nut, with: M16 thread	SACC-E-MU-M16	1504097 100

Accessories		
Flat nut, with: M16 thread	SACC-E-MU-M16	1504097 100

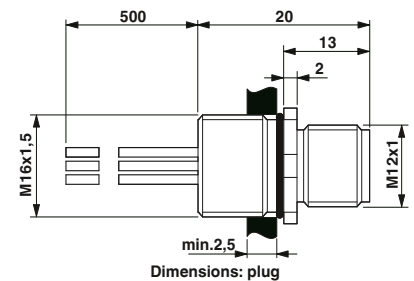
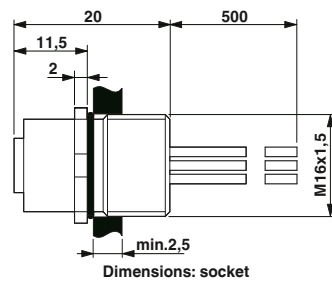

M12 sensor/actuator device connectors, front mounting

M16 fastening thread, with 0.5 m long litz wires, can be positioned



can be positioned, 4-, 5-pos.



can be positioned, 8-pos.



Technical data	
4-pos.	5-pos.
General data	
M12 circular connector according to: IEC 61076-2-101	
Pollution degree 3	
Degree of protection IP67	
Connection method Individual wires	
Electrical data	
Rated voltage 250 V	60 V
Rated current 4 A	4 A
Material data	
Material contact/contact surface CuZn / Ni/Au	CuZn / Ni/Au
Contact carrier material PA 66	PA 66
Inflammability class according to UL 94 V0	V0
Cable type TPE litz wire	TPE litz wire
Temperature data	
Plug/socket [°C]	-25 ... 85



Technical data	
8-pos.	
General data	
M12 circular connector according to: IEC 61076-2-101	
Pollution degree 3	
Degree of protection IP67	
Connection method Individual wires	
Electrical data	
Rated voltage 30 V	
Rated current 2 A	
Material data	
Material contact/contact surface CuZn / Ni/Au	
Contact carrier material PA 66	
Inflammability class according to UL 94 V0	
Cable type TPE litz wire	
Temperature data	
Plug/socket [°C]	-25 ... 85

		Ordering data			
Description	Coding	4-pos.		5-pos.	
		Order No.	Pcs. / Pkt.	Order No.	Pcs. / Pkt.
Device connectors					
Socket	A - standard	1523447	1	1520042	1
Plug	A - standard	1523463	1	1520068	1
Socket	D - data	1535215	1		
Plug	D - data	1552256	1		
Socket	B - inverse			1519998	1
Plug	B - inverse			1520026	1

		Ordering data			
Description	Coding	8-pos.			
		Order No.	Pcs. / Pkt.	Order No.	Pcs. / Pkt.
Socket		1523489	1		
Plug		1523502	1		

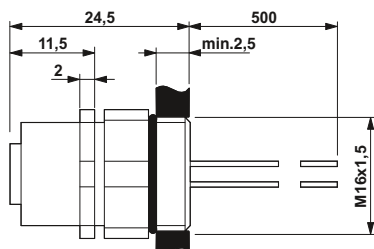

Dimensions: socket, can be positioned

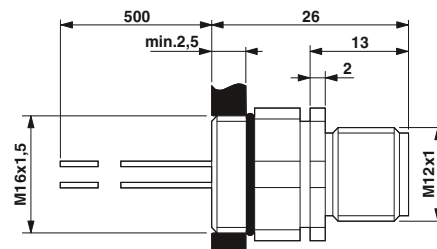

Dimensions: plug, can be positioned

Connectors

M12 sensor/actuator device connectors, front mounting

M12 XL device connector, M16 fastening thread, with 0.5 m long litz wires

- Tightening limitation
- Wrench size 19



4-, 5-, 8-pos.



12-, 17-pos.

	Technical data			Technical data			
	4-pos.	5-pos.	8-pos.	12-pos.	17-pos.		
General data							
M12 circular connector according to:	IEC 61076-2-101	IEC 61076-2-101	IEC 61076-2-101	IEC 61076-2-101	IEC 61076-2-101		
Pollution degree	3	3	3	3	3		
Degree of protection	IP65/IP67	IP65/IP67	IP65/IP67	IP65/IP67	IP65/IP67		
Connection method	Individual wires	Individual wires	Individual wires	Individual wires	Individual wires		
Electrical data							
Rated voltage	250 V	60 V	30 V	30 V	30 V		
Rated current	4 A	4 A	2 A	1.5 A	1.5 A		
Material data							
Material contact/contact surface	CuZn / Au	CuZn / Au	CuZn / Au	CuZn / Au	CuZn / Au		
Contact carrier material	PA 66	PA 66	PA 66	PA 66	PA 66		
Inflammability class according to UL 94	V0	V0	V0	V0	V0		
Cable type	TPE litz wire	TPE litz wire	TPE litz wire	TPE litz wire	TPE litz wire		
Temperature data							
Plug/socket	[-25 ... 85 °C]			[-25 ... 85 °C]			
Ordering data							
Description	Coding	Ordering data			Ordering data		
		Order No.	Pcs. / Pkt.	Order No.	Pcs. / Pkt.	Order No.	Pcs. / Pkt.
		4-pos.	5-pos.	8-pos.	12-pos.	17-pos.	
Device connectors							
Socket	A - standard	1411568	1	1411571	1	1411573	1
Plug	A - standard	1411577	1	1411579	1	1411581	1
Socket	D - data	1411569	1				
Plug	D - data	1411578	1				
Socket	B - inverse			1411572	1		
Plug	B - inverse			1411580	1		
Accessories							
Flat nut, with:		SACC-E-MU-M16			SACC-E-MU-M16		
M16 thread			1504097	100		1504097	100

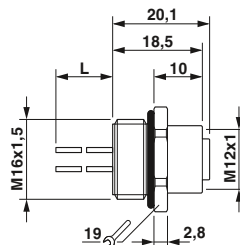

Dimensions: socket

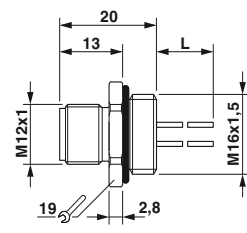

Dimensions: plug

M20 fastening thread, with 0.5 m long litz wires

– Housing material: brass, nickel-plated



4-, 5-, 8-pos.



	Technical data						
	4-pos.	5-pos.	8-pos.				
General data							
M12 circular connector according to:	IEC 61076-2-101	IEC 61076-2-101	IEC 61076-2-101				
Pollution degree	3	3	3				
Degree of protection	IP67/IP69K	IP67/IP69K	IP67/IP69K				
Connection method	Individual wires	Individual wires	Individual wires				
Electrical data							
Rated voltage	250 V	60 V	30 V				
Rated current	4 A	4 A	2 A				
Material data							
Material contact/contact surface	CuZn / Au	CuZn / Au	CuZn / Au				
Contact carrier material	PA 66	PA 66	PA 66				
Inflammability class according to UL 94	V0	V0	V0				
Cable type	TPE litz wire	TPE litz wire	TPE litz wire				
Temperature data							
Plug/socket	-25 ... 85	-25 ... 85	-25 ... 85				
			[°C]				
Ordering data							
Description	Coding	Order No.	Pcs. / Pkt.	Order No.	Pcs. / Pkt.	Order No.	Pcs. / Pkt.
		4-pos.		5-pos.		8-pos.	
Device connectors							
Socket	A - standard	1408436	1	1408454	1	1408453	1
Plug	A - standard	1408451	1	1408446	1	1408442	1

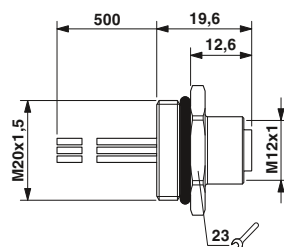

Dimensions: socket

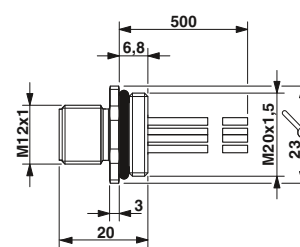

Dimensions: plug

Connectors

M12 sensor/actuator device connectors, front mounting

One-piece, 20 mm square flange, with 0.5 m long litz wires

- 4x fixing hole, 3.2 mm
- With form seal for M3 screws



4-, 5-, 8-pos.



12-, 17-pos.



	Technical data			Technical data			
	4-pos.	5-pos.	8-pos.	12-pos.	17-pos.		
General data							
M12 circular connector according to:	IEC 61076-2-101	IEC 61076-2-101	IEC 61076-2-101	IEC 61076-2-101	IEC 61076-2-101		
Pollution degree	3	3	3	3	3		
Degree of protection	IP67	IP67	IP67	IP67	IP67		
Connection method	Individual wires	Individual wires	Individual wires	Individual wires	Individual wires		
Electrical data							
Rated voltage	250 V	60 V	30 V	30 V	30 V		
Rated current	4 A	4 A	2 A	1.5 A	1.5 A		
Material data							
Material contact/contact surface	CuZn / Ni/Au	CuZn / Ni/Au	CuZn / Ni/Au	CuZn / Ni/Au	CuZn / Ni/Au		
Contact carrier material	PA 66	PA 66	PA 66	PA 66	PA 66		
Inflammability class according to UL 94	V0	V0	V0	V0	V0		
Cable type	TPE litz wire	TPE litz wire	TPE litz wire	TPE litz wire	TPE litz wire		
Temperature data							
Plug/socket	-25 ... 85	-25 ... 85	-25 ... 85	-25 ... 85	-25 ... 85	[°C]	
		Ordering data			Ordering data		
Description	Coding	Order No.	Pcs. / Pkt.	Order No.	Pcs. / Pkt.	Order No.	Pcs. / Pkt.
		4-pos.		5-pos.		8-pos.	
		12-pos.		17-pos.			
Device connectors							
Socket	A - standard	1419797	1	1441655	1	1441697	1
Plug	A - standard	1419784	1	1441642	1	1441684	1
Socket	D - data	1441639	1				
Plug	D - data	1441626	1				
Socket	B - inverse			1441671	1		
Plug	B - inverse			1441668	1		

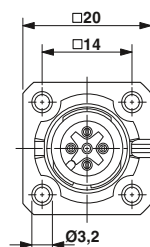

Dimensions: socket

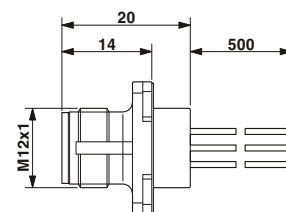
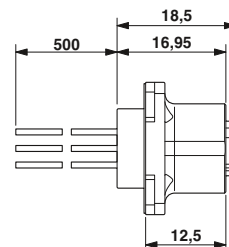

Dimensions: plug

M12 sensor/actuator device connectors, front mounting

One-piece, 25 mm square flange, with 0.5 m long litz wires

- 4 x fixing hole, 2.7 mm
- with form seal for M2.5 screws



4-, 5-, 8-pos.



12-, 17-pos.



	Technical data		
	4-pos.	5-pos.	8-pos.
General data			
M12 circular connector according to:	IEC 61076-2-101	IEC 61076-2-101	IEC 61076-2-101
Pollution degree	3	3	3
Degree of protection	IP67	IP67	IP67
Connection method	Individual wires	Individual wires	Individual wires
Electrical data			
Rated voltage	250 V	60 V	30 V
Rated current	4 A	4 A	2 A
Material data			
Material contact/contact surface	CuZn / Ni/Au	CuZn / Ni/Au	CuZn / Ni/Au
Contact carrier material	PA 66	PA 66	PA 66
Inflammability class according to UL 94	V0	V0	V0
Cable type	TPE litz wire	TPE litz wire	TPE litz wire
Temperature data			
Plug/socket	-25 ... 85	-25 ... 85	-25 ... 85



	Technical data	
	12-pos.	17-pos.
General data		
M12 circular connector according to:	IEC 61076-2-101	IEC 61076-2-101
Pollution degree	3	3
Degree of protection	IP67	IP67
Connection method	Individual wires	Individual wires
Electrical data		
Rated voltage	30 V	30 V
Rated current	1.5 A	1.5 A
Material data		
Material contact/contact surface	CuZn / Ni/Au	CuZn / Ni/Au
Contact carrier material	PA 66	PA 66
Inflammability class according to UL 94	V0	V0
Cable type	TPE litz wire	TPE litz wire
Temperature data		
Plug/socket	-25 ... 85	-25 ... 85

Description	Coding	Ordering data					
		4-pos.		5-pos.		8-pos.	
		Order No.	Pcs. / Pkt.	Order No.	Pcs. / Pkt.	Order No.	Pcs. / Pkt.
Device connectors							
Socket	A - standard	1420003	1	1440986	1	1441574	1
Plug	A - standard	1419991	1	1440973	1	1441561	1
Socket	D - data	1440960	1				
Plug	D - data	1440957	1				
Socket	B - inverse			1441558	1		
Plug	B - inverse			1440999	1		

Description	Coding	Ordering data			
		12-pos.		17-pos.	
		Order No.	Pcs. / Pkt.	Order No.	Pcs. / Pkt.
Device connectors					
Socket	A - standard	1441590	1	1441613	1
Plug	A - standard	1441587	1	1441600	1

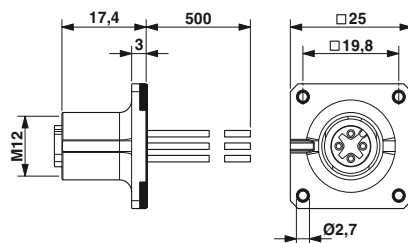

Dimensions: socket

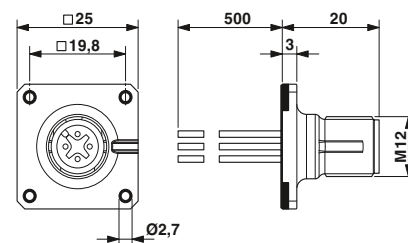

Dimensions: plug

Connectors

M12 sensor/actuator device connectors, front mounting

Modular, 25 mm square flange, pre-assembled



Flange housing, housing bore holes 3.2 mm



with 0.5 m long litz wires, assembled contact carrier and insulating body

ERC

Technical data

General data			
M12 circular connector according to:	IEC 61076-2-101		
Pollution degree	-		
Degree of protection	-		
Connection method	-		
Electrical data			
Rated voltage	-		
Rated current	-		
Material data			
Material contact/contact surface	- / -		
Contact carrier material	-		
Cable gland material	Zinc die-cast, nickel-plated		
Inflammability class according to UL 94	-		
Cable type	-		
Temperature data			
Plug/socket	[°C]	-25 ... 85	

Ordering data

Description	Coding	Order No.	Pcs. / Pkt.	Order No.	Pcs. / Pkt.	Order No.	Pcs. / Pkt.
		4-pos.	5-pos.	8-pos.			
Square flange housing, with O-ring		1419959	10				
Assembled contact carrier and insulating body, with 0.5 m litz wires and crimp contacts							
Plug	A - standard						
Plug	D - data						
Plug	B - inverse						

ERC

Technical data

4-pos.	5-pos.	8-pos.
IEC 61076-2-101	IEC 61076-2-101	IEC 61076-2-101
3	3	3
IP67	IP67	IP67
Crimp contacts	Crimp contacts	Crimp contacts
250 V	60 V	30 V
4 A	4 A	2 A
CuZn / Au	CuZn / Au	CuZn / Au
PA 66	PA 66	PA 66
-	-	-
V0	V0	V0
TPE litz wire	TPE litz wire	TPE litz wire
-25 ... 85	-25 ... 85	-25 ... 85

Ordering data

Order No.	Pcs. / Pkt.	Order No.	Pcs. / Pkt.	Order No.	Pcs. / Pkt.
4-pos.	5-pos.	8-pos.			
1440805	1	1440818	1	1457827	1
1440821	1	1440759	1		

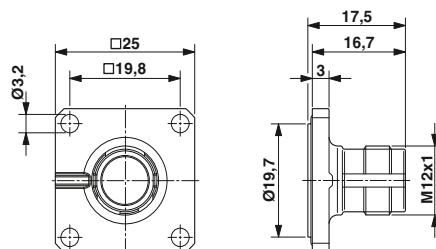

M12 square flange housing

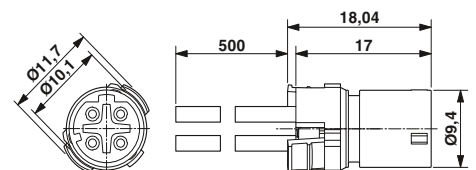

M12 contact carrier, with litz wires

M12 sensor/actuator device connectors, front mounting

Modular, 25 mm square flange, for free assembly



Flange housing, housing bore holes 3.2 mm



Contact carriers and insulating bodies for assembly

ERC

Technical data

General data	
M12 circular connector according to:	IEC 61076-2-101
Pollution degree	-
Degree of protection	-
Connection method	-
Electrical data	
Rated voltage	-
Rated current	-
Material data	
Contact carrier material	-
Cable gland material	Zinc die-cast, nickel-plated
Inflammability class according to UL 94	-
Temperature data	
Plug/socket	[°C] -25 ... 85

Ordering data

Description	Coding	Order No.	Pcs. / Pkt.
-------------	--------	-----------	-------------

Square flange housing, with O-ring

Contact carriers and insulating bodies		Order No.	Pcs. / Pkt.
Plug	A - standard		
Plug	D - data		
Plug	B - inverse		

Crimp contacts, for 4- and 5-pos. contact carriers, contact material: CuZn, surface: gold-plated, connection cross section: 0.08 mm² ... 0.34 mm²

Contact Ø: 1.0 mm

Crimp contacts, for 8-pos. contact carriers, contact material: CuZn, surface: gold-plated, connection cross section: 0.08 mm² ... 0.34 mm²

Contact Ø: 0.8 mm

Accessories

Crimping pliers	Order No.	Pcs. / Pkt.
-----------------	-----------	-------------

ERC

Technical data

4-pos.	5-pos.	8-pos.
IEC 61076-2-101	IEC 61076-2-101	IEC 61076-2-101
3	3	3
IP67	IP67	IP67
Crimp contacts	Crimp contacts	Crimp contacts
250 V	60 V	30 V
4 A	4 A	2 A
PA 66	PA 66	PA 66
-	-	-
V0	V0	V0
-25 ... 85	-25 ... 85	-25 ... 85

Ordering data

Order No.	Pcs. / Pkt.	Order No.	Pcs. / Pkt.	Order No.	Pcs. / Pkt.
4-pos.		5-pos.		8-pos.	

1440931	10	1419988	10	1440928	10
1440944	10	1440915	10		

1452356	100	1452356	100		
				1452372	100

Accessories

CRIMPFOX-TC MP	Order No.	Pcs. / Pkt.
	1212510	1

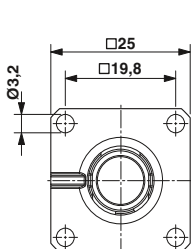

M12 square flange housing

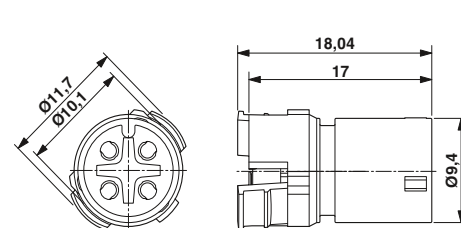

M12 contact carrier

Connectors

M12 sensor/actuator device connectors, rear mounting

Pg9 fastening thread, with 0.5 m long litz wires



4-, 5-, 8-pos.



12-, 17-pos.



	Technical data			Technical data			
	4-pos.	5-pos.	8-pos.	12-pos.	17-pos.		
General data							
M12 circular connector according to:	IEC 61076-2-101	IEC 61076-2-101	IEC 61076-2-101	IEC 61076-2-101	IEC 61076-2-101		
Pollution degree	3	3	3	3	3		
Degree of protection	IP67	IP67	IP67	IP67	IP67		
Connection method	Individual wires	Individual wires	Individual wires	Individual wires	Individual wires		
Electrical data							
Rated voltage	250 V	60 V	30 V	30 V	30 V		
Rated current	4 A	4 A	2 A	1.5 A	1.5 A		
Material data							
Material contact/contact surface	CuZn / Au	CuZn / Au	CuZn / Au	CuZn / Au	CuZn / Au		
Contact carrier material	PA 66	PA 66	PA 66	PA 66	PA 66		
Inflammability class according to UL 94	V0	V0	V0	V0	V0		
Cable type	TPE litz wire	TPE litz wire	TPE litz wire	TPE litz wire	TPE litz wire		
Temperature data							
Plug/socket	[-25 ... 85]			[-25 ... 85]			
Ordering data							
Description	Coding	Ordering data			Ordering data		
		Order No.	Pcs. / Pkt.	Order No.	Pcs. / Pkt.	Order No.	Pcs. / Pkt.
		4-pos.	5-pos.	8-pos.	12-pos.	17-pos.	
Device connectors							
Socket	A - standard	1556621	1	1542729	1	1542732	1
Plug	A - standard	1556618	1	1542703	1	1542716	1
Socket	D - data	1551529	1				
Plug	D - data	1551532	1				
Socket	B - inverse			1543676	1		
Plug	B - inverse			1543663	1		

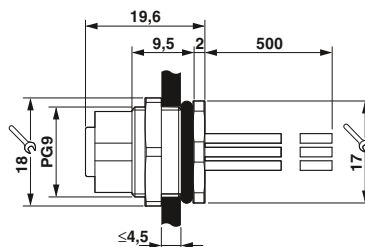

Dimensions: socket

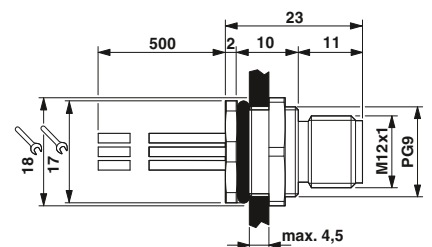

Dimensions: plug

M12 sensor/actuator device connectors, rear mounting

M12 fastening thread, with 0.5 m long litz wires



4-, 5-, 8-pos.



12-, 17-pos.



	Technical data		
	4-pos.	5-pos.	8-pos.
General data			
M12 circular connector according to:	IEC 61076-2-101	IEC 61076-2-101	IEC 61076-2-101
Pollution degree	3	3	3
Degree of protection	IP67	IP67	IP67
Connection method	Individual wires	Individual wires	Individual wires
Electrical data			
Rated voltage	250 V	60 V	30 V
Rated current	4 A	4 A	2 A
Material data			
Material contact/contact surface	CuZn / Au	CuZn / Au	CuZn / Au
Contact carrier material	PA 66	PA 66	PA 66
Inflammability class according to UL 94	V0	V0	V0
Cable type	TPE litz wire	TPE litz wire	TPE litz wire
Temperature data			
Plug/socket	-25 ... 85	-25 ... 85	-25 ... 85



	Technical data	
	12-pos.	17-pos.
General data		
M12 circular connector according to:	IEC 61076-2-101	IEC 61076-2-101
Pollution degree	3	3
Degree of protection	IP67	IP67
Connection method	Individual wires	Individual wires
Electrical data		
Rated voltage	30 V	30 V
Rated current	1.5 A	1.5 A
Material data		
Material contact/contact surface	CuZn / Au	CuZn / Au
Contact carrier material	PA 66	PA 66
Inflammability class according to UL 94	V0	V0
Cable type	TPE litz wire	TPE litz wire
Temperature data		
Plug/socket	-25 ... 85	-25 ... 85

Description	Coding	Ordering data					
		4-pos.		5-pos.		8-pos.	
		Order No.	Pcs. / Pkt.	Order No.	Pcs. / Pkt.	Order No.	Pcs. / Pkt.
Device connectors							
Plug	A - standard	1551875	1	1551888	1	1551914	1
Plug	D - data	1551901	1				
Plug	B - inverse			1551891	1		

Description	Coding	Ordering data			
		12-pos.		17-pos.	
		Order No.	Pcs. / Pkt.	Order No.	Pcs. / Pkt.
Device connectors					
Plug		1437122	1	1437135	1

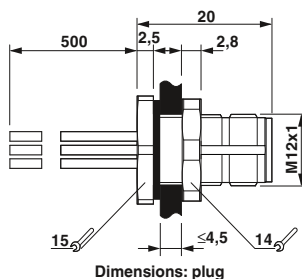

Connectors

M12 sensor/actuator device connectors, rear mounting

M16 fastening thread, with 0.5 m long litz wires



4-, 5-, 8-pos.



12-, 17-pos.



	Technical data		
	4-pos.	5-pos.	8-pos.
General data			
M12 circular connector according to:	IEC 61076-2-101	IEC 61076-2-101	IEC 61076-2-101
Pollution degree	3	3	3
Degree of protection	IP65/IP67	IP65/IP67	IP65/IP67
Connection method	Individual wires	Individual wires	Individual wires
Electrical data			
Rated voltage	250 V	60 V	30 V
Rated current	4 A	4 A	2 A
Material data			
Material contact/contact surface	CuZn / Au	CuZn / Au	CuZn / Au
Contact carrier material	PA 66	PA 66	PA 66
Inflammability class according to UL 94	V0	V0	V0
Cable type	TPE litz wire	TPE litz wire	TPE litz wire
Temperature data			
Plug/socket	-25 ... 85	-25 ... 85	-25 ... 85



	Technical data	
	12-pos.	17-pos.
General data		
M12 circular connector according to:	IEC 61076-2-101	IEC 61076-2-101
Pollution degree	3	3
Degree of protection	IP65/IP67	IP65/IP67
Connection method	Individual wires	Individual wires
Electrical data		
Rated voltage	30 V	30 V
Rated current	1.5 A	1.5 A
Material data		
Material contact/contact surface	CuZn / Au	CuZn / Au
Contact carrier material	PA 66	PA 66
Inflammability class according to UL 94	V0	V0
Cable type	TPE litz wire	TPE litz wire
Temperature data		
Plug/socket	-25 ... 85	-25 ... 85

Description	Coding	Ordering data					
		4-pos.		5-pos.		8-pos.	
		Order No.	Pcs. / Pkt.	Order No.	Pcs. / Pkt.	Order No.	Pcs. / Pkt.
Device connectors							
Socket	A - standard	1419632	1	1419658	1	1419690	1
Plug	A - standard	1419629	1	1419645	1	1419687	1
Socket	D - data	1419616	1				
Plug	D - data	1419603	1				
Socket	B - inverse			1419674	1		
Plug	B - inverse			1419661	1		

Description	Coding	Ordering data			
		12-pos.		17-pos.	
		Order No.	Pcs. / Pkt.	Order No.	Pcs. / Pkt.
Socket	A - standard	1419713	1	1419739	1
Plug	A - standard	1419700	1	1419726	1

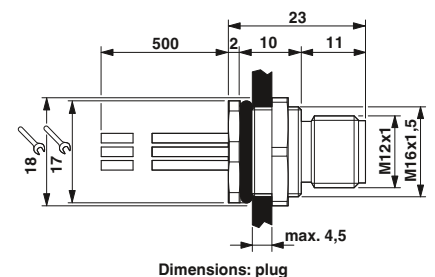
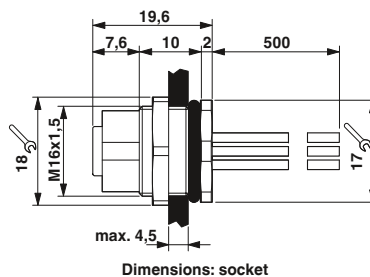

M12 sensor/actuator device connectors, rear mounting

M12 XL device connector, M16 fastening thread, with 0.5 m long litz wires

- Tightening limitation
- Wrench size 19



4-, 5-, 8-pos.



12-, 17-pos.

	Technical data			Technical data							
	4-pos.	5-pos.	8-pos.	12-pos.	17-pos.						
General data											
M12 circular connector according to:	IEC 61076-2-101	IEC 61076-2-101	IEC 61076-2-101	IEC 61076-2-101	IEC 61076-2-101						
Pollution degree	3	3	3	3	3						
Degree of protection	IP65/IP67	IP65/IP67	IP65/IP67	IP65/IP67	IP65/IP67						
Connection method	Individual wires	Individual wires	Individual wires	Individual wires	Individual wires						
Electrical data											
Rated voltage	250 V	60 V	30 V	30 V	30 V						
Rated current	4 A	4 A	2 A	1.5 A	1.5 A						
Material data											
Material contact/contact surface	CuZn / Au	CuZn / Au	CuZn / Au	CuZn / Au	CuZn / Au						
Contact carrier material	PA 66	PA 66	PA 66	PA 66	PA 66						
Inflammability class according to UL 94	V0	V0	V0	V0	V0						
Cable type	TPE litz wire	TPE litz wire	TPE litz wire	TPE litz wire	TPE litz wire						
Temperature data											
Plug/socket	-25 ... 85	-25 ... 85	-25 ... 85	-25 ... 85	-25 ... 85						
	Ordering data			Ordering data							
Description	Coding	Order No.	Pcs. / Pkt.	Order No.	Pcs. / Pkt.	Order No.	Pcs. / Pkt.	Order No.	Pcs. / Pkt.		
		4-pos.		5-pos.		8-pos.		12-pos.		17-pos.	
Device connectors											
Socket	A - standard	1411584	1	1411586	1	1411588	1	1411589	1	1411590	1
Plug	A - standard	1411591	1	1411593	1	1411595	1	1411596	1	1411597	1
Socket	D - data	1411585	1								
Plug	D - data	1411592	1								
Socket	B - inverse			1411587	1						
Plug	B - inverse			1411594	1						

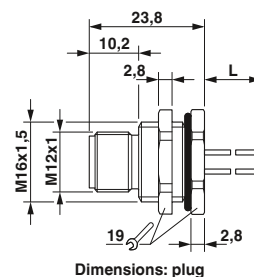
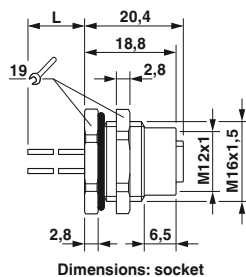

Connectors

M12 sensor/actuator device connectors, rear mounting

M16 fastening thread, with assembled cable, shielded



PUR cable,
4-, 5-, 8-pos., shielded



PVC cable,
12-, 17-pos., shielded

ERC

	Technical data		
	4-pos.	5-pos.	8-pos.
General data			
M12 circular connector according to:	IEC 61076-2-101	IEC 61076-2-101	IEC 61076-2-101
Pollution degree	3	3	3
Degree of protection	IP67	IP67	IP67
Connection method	Individual wires	Individual wires	Individual wires
Electrical data			
Rated voltage	250 V	60 V	30 V
Rated current	4 A	4 A	2 A
Material data			
Material contact/contact surface	CuZn / Au	CuZn / Au	CuZn / Au
Contact carrier material	PA 66	PA 66	PA 66
Inflammability class according to UL 94	V0	V0	V0
Cable type	PUR halogen-free, black	PUR halogen-free, black	PUR halogen-free, black
Temperature data			
Plug/socket	-25 ... 85	-25 ... 85	-25 ... 85

ERC

	Technical data	
	12-pos.	17-pos.
General data		
M12 circular connector according to:	IEC 61076-2-101	IEC 61076-2-101
Pollution degree	3	3
Degree of protection	IP67	IP67
Connection method	Individual wires	Individual wires
Electrical data		
Rated voltage	30 V	30 V
Rated current	1.5 A	1.5 A
Material data		
Material contact/contact surface	CuZn / Au	CuZn / Au
Contact carrier material	PA 66	PA 66
Inflammability class according to UL 94	V0	V0
Cable type	PVC black	PVC black
Temperature data		
Plug/socket	-25 ... 85	-25 ... 85

Description	Cable length	Ordering data									
		4-pos.		5-pos.		8-pos.					
		Order No.	Pcs. / Pkt.	Order No.	Pcs. / Pkt.	Order No.	Pcs. / Pkt.				
Device connector, A-coded											
Socket	1 m	1419302	1	1419328	1	1419357	1	1442188	1	1442269	1
Plug	1 m	1419399	1	1419409	1	1419425	1	1442227	1	1442308	1
Socket	2 m	1419315	1	1419331	1	1419344	1	1442191	1	1442272	1
Plug	2 m	1419386	1	1419412	1	1419438	1	1442230	1	1442311	1

Description	Cable length	Ordering data									
		12-pos.		17-pos.		17-pos.					
		Order No.	Pcs. / Pkt.	Order No.	Pcs. / Pkt.	Order No.	Pcs. / Pkt.				
Device connector, A-coded											
Socket	1 m	1419302	1	1419328	1	1419357	1	1442188	1	1442269	1
Plug	1 m	1419399	1	1419409	1	1419425	1	1442227	1	1442308	1
Socket	2 m	1419315	1	1419331	1	1419344	1	1442191	1	1442272	1
Plug	2 m	1419386	1	1419412	1	1419438	1	1442230	1	1442311	1

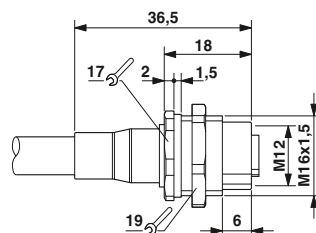

Dimensions: socket

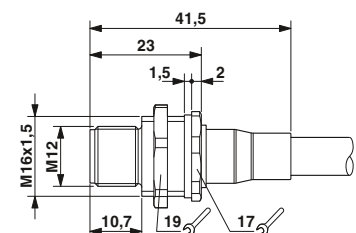

Dimensions: plug

Pg9 fastening thread, plastic, with 0.5 m long litz wires



5-, 8-pos.

ERC

		Technical data			
		5-pos.	8-pos.		
General data					
M12 circular connector according to:		IEC 61076-2-101	IEC 61076-2-101		
Pollution degree		3	3		
Degree of protection		IP67	IP67		
Electrical data					
Rated voltage		60 V	30 V		
Rated current		4 A	2 A		
Material data					
Material contact/contact surface		CuZn / Au	CuZn / Au		
Contact carrier material		PA 66	PA 66		
Inflammability class according to UL 94		HB	HB		
Temperature data					
Plug/socket [°C]		-25 ... 85	-25 ... 85		
		Ordering data			
Description	Coding	Order No.	Pcs. / Pkt.	Order No.	Pcs. / Pkt.
		5-pos.		8-pos.	
Device connectors					
Socket	A - standard	1436356	1	1436369	1

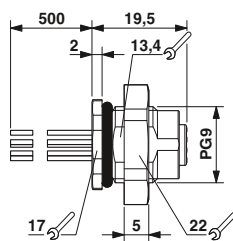

Dimensions: socket

Connectors

M12 sensor/actuator device connectors, rear mounting

Control cabinet feed-through



4-, 5-, 8-pos.

ERC

Technical data

	4-pos.	5-pos.	8-pos.
General data			
M12 circular connector according to:	IEC 61076-2-101	IEC 61076-2-101	IEC 61076-2-101
Pollution degree	3	3	3
Degree of protection	IP67	IP67	IP67
Electrical data			
Rated voltage	250 V	60 V	30 V
Rated current	4 A	4 A	2 A
Material data			
Contact material	CuZn	CuZn	CuZn
Contact surface material	Au	Au	Au
Contact carrier material	PA 66	PA 66	PA 66
Inflammability class according to UL 94	HB	HB	HB
Temperature data			
Plug/socket	-25 ... 85	-25 ... 85	-25 ... 85

Ordering data

Description	Coding	4-pos.		5-pos.		8-pos.	
		Order No.	Pcs. / Pkt.	Order No.	Pcs. / Pkt.	Order No.	Pcs. / Pkt.
Control cabinet feed-through, M16 fastening thread							
Pin to socket	A - standard			1551671	1	1551697	1
Pin to socket	B - inverse			1551684	1		
Socket to socket	D - data	1424326	1				

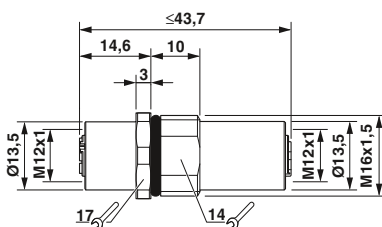

Control cabinet feed-through, socket to socket on both sides

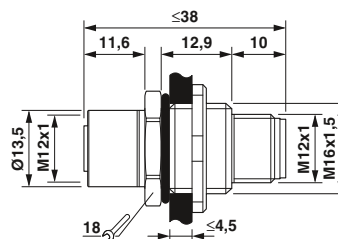

Control cabinet feed-through, socket to pin on both sides

7/8" sensor/actuator device connectors, front mounting

Pg13.5 fastening thread, with 0.5 m long litz wires

Notes:

Flat nut recommended for housing wall thicknesses < 2.5 mm.



3-, 4-pos.



5-pos.



Technical data

	3-pos.	4-pos.
General data		
Pollution degree	3	3
Degree of protection	IP67	IP67
Connection method	Individual wires	Individual wires
Electrical data		
Rated voltage	250 V	250 V
Rated current	12 A	9 A
Surge voltage category	II	II
Material data		
Material contact/contact surface	CuZn / Au	CuZn / Au
Contact carrier material	PUR	PUR
Inflammability class according to UL 94	HB	HB
Cable type	PVC litz wire	PVC litz wire
Temperature data		
Plug/socket	-40 ... 85	-40 ... 85

Ordering data

Description	Coding	3-pos.		4-pos.	
		Order No.	Pcs. / Pkt.	Order No.	Pcs. / Pkt.
Socket	A - standard	1521407	1	1521423	1
Plug	A - standard	1521410	1	1521436	1

Accessories

Flat nut, with: Pg13.5 thread	SACC-E-MU-PG13,5	1539143	100
----------------------------------	------------------	---------	-----



Technical data

	5-pos.
General data	
Pollution degree	3
Degree of protection	IP67
Connection method	Individual wires
Electrical data	
Rated voltage	250 V
Rated current	9 A
Surge voltage category	II
Material data	
Material contact/contact surface	CuZn / Au
Contact carrier material	PUR
Inflammability class according to UL 94	HB
Cable type	PVC litz wire
Temperature data	
Plug/socket	-40 ... 85

Ordering data

Description	Coding	5-pos.	
		Order No.	Pcs. / Pkt.
Socket	A - standard	1521449	1
Plug	A - standard	1521452	1

Accessories

Flat nut, with: Pg13.5 thread	SACC-E-MU-PG13,5	1539143	100
----------------------------------	------------------	---------	-----

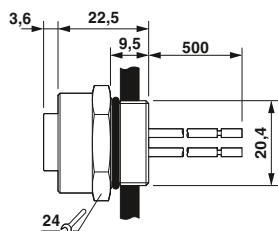

Dimensions: socket

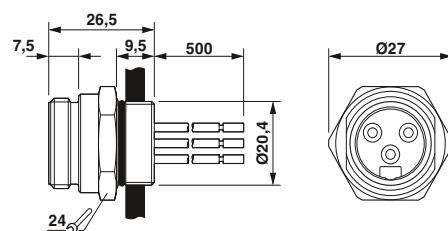

Dimensions: plug

Connectors

7/8" sensor/actuator device connectors, rear mounting

7/8", with 1.0 m long litz wires



3-, 4-, 5-position



3-, 4-, 5-position



Technical data

General data
Pollution degree
Degree of protection
Connection method
Electrical data
Rated voltage
Rated current
Surge voltage category
Material data
Contact material
Contact surface material
Contact carrier material
Inflammability class according to UL 94
Temperature data
Plug/socket

	3-pos.	4-pos.	5-pos.
3	3	3	
IP67	IP67	IP67	
Individual wires	Individual wires	Individual wires	
250 V	250 V	250 V	
12 A	9 A	9 A	
II	II	II	
CuZn	CuZn	CuZn	
Au	Au	Au	
PUR	PUR	PUR	
HB	HB	HB	
-40 ... 85	-40 ... 85	-40 ... 85	



Technical data

	3-pos.	4-pos.	5-pos.
3	3	3	
IP67	IP67	IP67	
Individual wires	Individual wires	Individual wires	
250 V	250 V	250 V	
12 A	9 A	9 A	
II	II	II	
CuZn	CuZn	CuZn	
Au	Au	Au	
PUR	PUR	PUR	
HB	HB	HB	
-40 ... 85	-40 ... 85	-40 ... 85	

Ordering data

Description
Device connector, M26 fastening thread
Socket
Device connector, 7/8" fastening thread
Plug

Order No.	Pcs. / Pkt.	Order No.	Pcs. / Pkt.	Order No.	Pcs. / Pkt.
3-pos.		4-pos.		5-pos.	
1453782	1	1453795	1	1453805	1

Ordering data

Order No.	Pcs. / Pkt.	Order No.	Pcs. / Pkt.	Order No.	Pcs. / Pkt.
3-pos.		4-pos.		5-pos.	
1453753	1	1453766	1	1453799	1

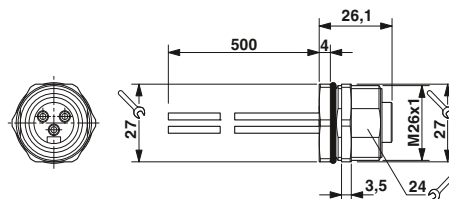

Dimensions: socket

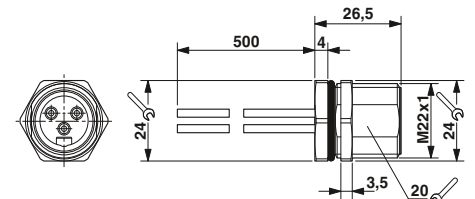

Dimensions: plug

Sealing elements

During transport or in the field, unoccupied plug-in connections must be protected or closed. The screw plugs, sealing caps and closing caps made of plastic or metal are suitable for this purpose. These achieve the IP65/IP67 as well as IP69K degrees of protection.



Description	Ordering data		
	Type	Order No.	Pcs. / Pkt.
M5 screw plug for unused M5 sockets of sensor/actuator cables, boxes, and device connectors ①	PROT-M5	1533288	10
M8 screw plug for unused M8 sockets of sensor/actuator cables, boxes, and device connectors ②	PROT-M8	1682540	5
M12 screw plug for unused M12 sockets of sensor/actuator cables, boxes, and device connectors ③	PROT-M12	1680539	5
M12 screw plug with SPEEDCON quick locking for unused M12 sockets of sensor/actuator cables, boxes, and device connectors ④	PROT-MS SCO	1553129	5
M12 sealing cap for unused M12 connectors of sensor/actuator cables, device connectors, and I/O devices in the field ⑤	PROT-M12 FS	1560251	5
Screw plug M12, made of metal for unused M12 sockets of shielded sensor/actuator cables, boxes, and device connectors ⑥	PROT-M12 SH	1503302	5
Metal M12 sealing cap for unused M12 connectors of sensor/actuator cables, device connectors, and I/O devices in the field ⑦	PROT-M12 FS-M	1430488	10
for unused M12 sockets M12 screw plug made of stainless steel ⑧	PROT-M12 MS-M	1414148	10
for unused M12 sockets of sensor/actuator cables, boxes, and device connectors in the food and outdoor range	PROT-M12 FB	1555538	5
Closing cap for Pg9/ Pg11, to close unoccupied connections ⑨	Q-PROT 9/11	1670235	10
M16 locking screw With flat nut for oval housing cutouts ⑩	SACC-M16-SEALING PLUG SET	1453368	10

Sealing elements with holding band or fixing chain

All IP67 interfaces can be closed tightly using the screw plugs and sealing caps in the sizes M8, M12, and 7/8". The holding bands are fastened on the cable or the housing and are thus held captive.

The M12 metal protective cap with fixing chain is suitable for all pin versions. It is used in harsh industrial environments or for EMC applications.



		Ordering data		
Description	Type	Order No.	Pcs. / Pkt.	
Screw plug made from plastic with retaining strap, for sealing unused sockets ①				
M8 for SAC cables	PROT-M 8 MS-PA-CHAIN	1430860	10	
M8 with 3 mm fastening eye	PROT-M 8 MS-PA-CHAIN-EYE-DM3	1441105	10	
M8 with 12 mm fastening eye	PROT-M 8 MS-PA-CHAIN-EYE	1441095	10	
M12 for SAC cables	PROT-M12 MS-PA-CHAIN	1430899	5	
M12 with 15 mm fastening eye	PROT-M12 MS-PA-CHAIN-EYE-DM14	1456200	5	
7/8" for SAC cables	PROT-MINMS-PA-CHAIN	1430925	10	
Plastic sealing cap with holding band, for closing unoccupied connectors ②				
M8 for SAC cables	PROT-M 8 FS-PA-CHAIN	1430857	10	
M8 with 8 mm fastening eye	PROT-M 8 FS-PA-CHAIN-EYE	1441082	10	
M12 for SAC cables	PROT-M12 FS-PA-CHAIN	1430873	5	
M12 with 12 mm fastening eye	PROT-M12 FS-PA-CHAIN-EYE-DM12	1456187	5	
M12 with 15 mm fastening eye	PROT-M12 FS-PA-CHAIN-EYE-DM14	1456190	5	
7/8" for SAC cables	PROT-MINFS-PA-CHAIN	1430912	10	
Sealing cap made of metal with fixing chain and 16 mm fastening eye, for sealing: ③				
unused M12 connectors	PROT-M12 FS-M-CHAIN	1430491	10	
unused M12 sockets	PROT-M12 MS-M-CHAIN	1414147	1	

Connectors

Accessories

Accessories for device connectors

Special fixing nuts are available for EMC-compliant installation of M12 device connectors for coated or painted housing surfaces. When tightened they cut through the surface coating and establish contact between the housing and the connector.

Flat seals can be used as an alternative option between the housing wall and the device connector. Flat seals are to be preferred for thin walls, as the housing cutouts do not have to be chamfered.



Description	Ordering data		
	Type	Order No.	Pcs. / Pkt.
EMC hexagonal nut with fine tooting, for all device connectors with: ①			
M12 fastening thread	SACC-M12-KD-NUT-SH	1440151	10
EMC hexagonal nut with fine tooting, for all device connectors with: ②			
M16 fastening thread	SACC-M16-KD-NUT-SH	1440164	10
Pg9 fastening thread	SACC-PG9-KD-NUT-SH	1440177	10
Flat gasket for all device connectors with: ③			
M16 fastening thread	SACC-M16-SEAL CLM	1430394	10
Pg9 fastening thread	SACC-PG9-SEAL CLM	1556320	10

Assembly tools for sensor/actuator cables

To achieve tight plug-in connections, we recommend using assembly tools. M12 and 7/8" circular connectors can be assembled using a torque screwdriver and plug attachment.

The benefits of the plug attachment become particularly clear when connecting the connectors to the distributor boxes. Thanks to the open design, it enables quick adjustment and installation even when space is at a premium.

The version for M12 connectors with hexagonal stainless steel knurl is also made from stainless steel. This prevents the connector knurls from being contaminated by corrosive materials.

For greater flexibility, screwdrivers with adjustable torque are also available. When used in conjunction with the adapter insert, they can also be used to accommodate the available plug attachments.



		Ordering data		
Description	Type	Order No.	Pcs. / Pkt.	
Torque screwdriver With a preset torque of 0.8 Nm and a 4 mm hexagonal drive	TSD 08 SAC	1212597	1	
Nut For assembling 7/8" connectors, with 4 mm hexagonal drive	SAC BIT MIN-D25	1212512	1	
Torque screwdriver With preset torque of 0.4 Nm and 4 mm hexagonal drive	TSD 04 SAC	1208429	1	
Nut For mounting M12 connectors with hexagonal stainless steel knurl, wrench size 14, with 4 mm hexagonal drive	SAC BIT M12-W14	1212513	1	
Torque screwdriver , accuracy according to standard EN ISO 6789 Adjustable from 0.3 - 1.2 Nm Adjustable from 1.2 - 3 Nm Adjustable from 3 - 6 Nm	TSD-M 1,2NM TSD-M 3NM TSD-M 6NM	1212224 1212225 1212226	1 1 1	
Adapter insert For torque screwdrivers with adjustable torque, for accommodating plug attachments with 4 mm hexagonal drive	TSD-M SAC-BIT ADAPTER	1212600	1	

Connectors

Pin assignments

M5 device connectors

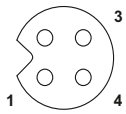

Socket, 3-pos.

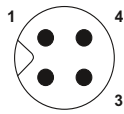

Pin, 3-pos.

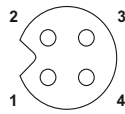

Socket, 4-pos.

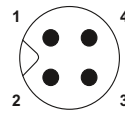

Pin, 4-pos.

Pin	3-pos.		4-pos.	
1	BN		BN	
2	-		WH	
3	BU		BU	
4	BK		BK	

M8 device connectors

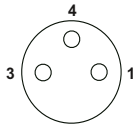

Socket, 3-pos.

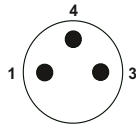

Pin, 3-pos.

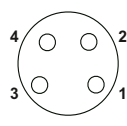

Socket, 4-pos.

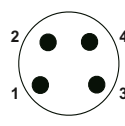

Pin, 4-pos.

Pin	3-pos., A-coded		4-pos., A-coded	
1	BN		BN	
2	-		WH	
3	BU		BU	
4	BK		BK	

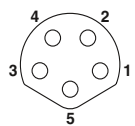

Socket, 5-pos., B-coded

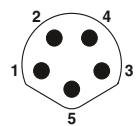

Pin, 5-pos., B-coded

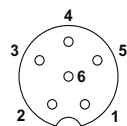

Socket, 6-pos.

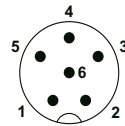

Pin, 6-pos.

Pin	5-pos. B-coded		6-pos., A-coded	
1	GY		BN	
2	RD		WH	
3	WH		BU	
4	BK		BK	
5	BU		GY	
6			PK	

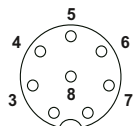

Socket, 8-pos.

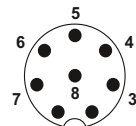

Pin, 8-pos.

Pin	8-pos., A-coded	
1	WH	
2	BN	
3	GN	
4	YE	
5	GY	
6	PK	
7	BU	
8	RD	

M12 device connectors

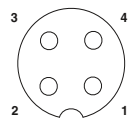

Socket, 4-pos., A-coded

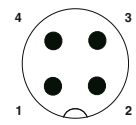

Pin, 4-pos., A-coded

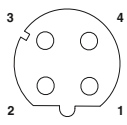

Socket, 4-pos., D-coded

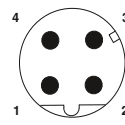

Pin, 4-pos., D-coded

Pin	4-pos., A-coded		4-pos., D-coded	
1	BN		YE	
2	WH		WH	
3	BU		OG	
4	BK		BU	

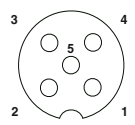

Socket, 5-pos., A-coded

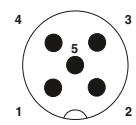

Pin, 5-pos., A-coded

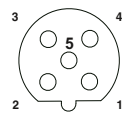

Socket, 5-pos., B-coded

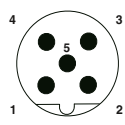

Pin, 5-pos., B-coded

Pin	5-pos., A-coded		5-pos., B-coded	
1	BN		BN	
2	WH		WH	
3	BU		BU	
4	BK		BK	
5	GY		GY	

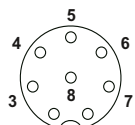

Socket, 8-pos.

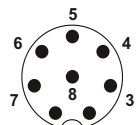

Pin, 8-pos.

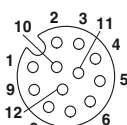

Socket, 12-pos.

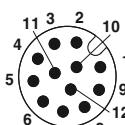

Pin, 12-pos.

Pin	8-pos.		12-pos.	
1	WH		BN	
2	BN		BU	
3	GN		WH	
4	YE		GN	
5	GY		PK	
6	PK		YE	
7	BU		BK	
8	RD		GY	
9	-		RD	
10	-		VT	
11	-		GYPK	
12	-		RDBU	

M12 device connectors

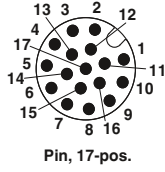
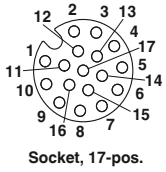

Pin	17-pos.	Pin	17-pos.
1	BN	9	RD
2	BU	10	VT
3	WH	11	GYPK
4	GN	12	RDBU
5	PK	13	WHGN
6	YE	14	BNGN
7	BK	15	WHYE
8	GY	16	YEEN
		17	WHGY

7/8" device connectors

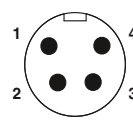
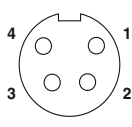
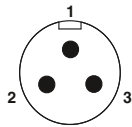
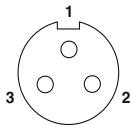

Pin	3-pos.	4-pos.
1	BK	BK
2	BN	BU
3	BU	BN
4	-	WH

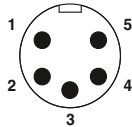
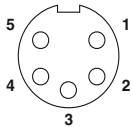

Pin	5-pos.
1	BK
2	BU
3	GNYE
4	BN
5	WH

Mechanical and electrical data

Mechanical data	
Housing material:	Copper zinc alloy (CuZn), die-cast zinc (GD-Zn)
Housing surface:	Nickel-plated/thick layer passivated (can be coated)
Insulating body:	Polyamide (PA 66)
Contact material:	Copper zinc alloy (CuZn)
Contact surface:	Nickel-plated (Ni) with gold coating (Au)
Contact connection method:	Crimp version
Sealing and O-ring:	Fluorocarbon rubber (FKM)
Ambient temperature:	-40°C ... 125°C
Cable entry:	Cable and coupler connectors for a cable outside diameter of 3.5 - 11 mm, shielded (M17 Compact) 5 - 12.5 mm, shielded (M17)
Type of locking:	M17 SPEEDCON fast locking system, cable connector with M17 x 1 coarse-pitch thread as an option
Mech. insertion/withdrawal cycles:	Standard: 100, punched-rolled C-HC crimp contacts: up to 500
Protection class:	IP67 when locked





Electrical data			
Number of positions		8	17
Contacts		8	17
Contact Ø	[mm]	1	0.6
Litz wire cross section, crimp contacts Turned	[mm ²]	0.06 ... 1.0	0.06 ... 0.5
Litz wire cross section, C-HC crimp contacts Punched-rolled	[mm ²]	0.06 ... 0.56	-
Nominal current per contact at 25°C ¹⁾		9.0	3.6
Specifications according to DIN EN 61984:2009			
Rated voltage	[V AC/DC]	60	60
Test/surge voltage	[kV AC]	1.5	1.5
Surge voltage category		III	III
Pollution degree ²⁾		3	3
Installation height	[m]	Up to 3000	Up to 3000
Cable clamping area ³⁾	Max. Ø [mm]	12.5	12.5

¹⁾ The effective current carrying capacity must be determined using a derating curve, if necessary, according to the application.

²⁾ The values specified assume that the connector pair is correctly locked and is only disconnected for testing and maintenance purposes. If the connector is unlocked and exposed to ambient conditions, and if there is a danger of pollution, the connector must be sealed using a protective cap ≥ IP54.

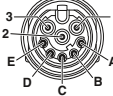
³⁾ The cable clamping areas specified on the following pages may vary depending on the cable material/structure. Selection and testing is the responsibility of the user.

Contact chamber numbering
(view of plug-in side)

Number of positions	Pin	Socket
<p>8-pos. Crimp</p>		
<p>17-pos. Crimp</p>		

Note:

The connectors can be fitted with pin or socket contacts according to the application.

For safety reasons, only socket contacts may be used in the live part of the connector.

Connectors

M17 - signal connectors

Selection guide

M17 signal connectors, 8 and 17-pos., crimp ranges: 0.06 mm² to 1.0 mm²

- Cable connectors
- Coupler connectors
- Device connectors (device flanges)

The connectors are supplied fully assembled and are complemented by the respective crimp contacts.

Each housing type can be fitted with pin or socket contacts.

Connectors with knurled nuts can be equipped with SPEEDCON fast locking system or with M17 x 1 coarse-pitch thread as an option. The connectors with external thread are fully compatible with standard threads and the SPEEDCON fast locking system.

The product chart provides an overview of the available components.

Connector type

Cable connectors

SPEEDCON fast locking system, M17 Compact, see page 62.



M17, see page 66.



M17 x 1 standard interlocking, M17, see page 67.

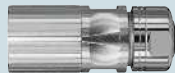

Square mounting flange for M17 cable and coupler connectors for wall mounting, see page 162.



Shielded

Coupler connectors/panel feed-through

Coupler connector M17 Compact, see page 63.



M17, see page 68.



Panel feed-through M17 Compact, see page 64.



Shielded

Device connectors

Straight, M17 Compact, see page 65.



Straight, M17, see page 69.



Straight, with central fastening thread, front mounting, M17, see page 71.



Straight, with central fastening thread, rear mounting, M17, see page 71.

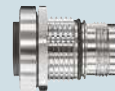

Shielded

Angled, rotatable, M17, see page 70.



Crimp contacts

Socket contacts

Turned, see page 73.



Punched-rolled, taped,
see page 72.



All housings can be fitted with pin or socket crimp contacts

Pin contacts

Turned, see page 73.



Punched-rolled, taped,
see page 72.



Tools/accessories

Crimping tools

Crimping pliers for punched-rolled
C-HC crimp contacts,
see page 158.



Crimping pliers with digital display for turned
crimp contacts,
see page 159.



Tools/accessories

Unlocking tool for device connectors with contact
carriers for snapping in from the device side,
see page 162.



Color rings for individually marking the connectors,
see page 164.

**Note:**

For reasons of safety, only socket contacts
may be used in the live part of the plug.

Connectors

M17 - signal connectors

M17 Compact cable connector

- High packing density in a compact product
- Individual marking of connectors with color rings



Cable connector,
socket assembly



Cable connector,
pin assembly

Description		Ordering data				Ordering data			
		Order No.	Pcs. / Pkt.	Order No.	Pcs. / Pkt.	Order No.	Pcs. / Pkt.	Order No.	Pcs. / Pkt.
	Cable clamping area	8-pos.		17-pos.		8-pos.		17-pos.	
Cable connector, with contact carrier, without contacts									
	3.5 mm ... 5.5 mm	1613370	1	1613288	1	1618641	1	1618682	1
	5 mm ... 9.2 mm	1613371	1	1613324	1	1618648	1	1618683	1
	9 mm ... 11.2 mm	1613372	1	1613325	1	1618649	1	1618684	1
		Accessories				Accessories			
Crimp contacts		For socket contacts, see page 72 onwards				For pin contacts, see page 72 onwards			
Color rings, 50 pcs. in set (to be ordered separately)		See page 164				See page 164			

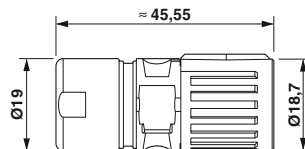

M17 Compact coupler connector

- Compatible with mating plugs with SPEEDCON or M17 standard knurled nuts
- Individual marking of connectors with color rings



Coupler connector, socket assembly



Coupler connector, pin assembly

Description	Cable clamping area	Ordering data				Ordering data			
		Order No.	Pcs. / Pkt.	Order No.	Pcs. / Pkt.	Order No.	Pcs. / Pkt.	Order No.	Pcs. / Pkt.
Coupler connector, with contact carrier, without contacts		8-pos.		17-pos.		8-pos.		17-pos.	
	3.5 mm ... 5.5 mm	1618724	1	1618756	1	1617799	1	1613497	1
	5 mm ... 9.2 mm	1618725	1	1618757	1	1617813	1	1613896	1
	9 mm ... 11.2 mm	1618726	1	1618758	1	1617830	1	1614532	1
		Accessories				Accessories			
Crimp contacts		For socket contacts, see page 72 onwards				For pin contacts, see page 72 onwards			
Color rings, 50 pcs. in set (to be ordered separately)		See page 164				See page 164			

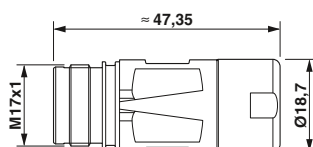

Connectors

M17 - signal connectors

M17 Compact panel feed-through

- Panel feed-throughs suitable for front and rear mounting
- Compatible with mating plugs with SPEEDCON or M17 standard knurled nuts
- Individual marking of connectors with color rings
- **Flange dimensions:**
25.7 mm x 25.7 mm



Panel feed-through, socket assembly



Panel feed-through, pin assembly

Description	Cable clamping area	Ordering data				Ordering data			
		Order No.	Pcs. / Pkt.	Order No.	Pcs. / Pkt.	Order No.	Pcs. / Pkt.	Order No.	Pcs. / Pkt.
Panel feed-through, with contact carrier, without contacts		8-pos.		17-pos.		8-pos.		17-pos.	
	3.5 mm ... 5.5 mm	1618801	1	1618834	1	1617925	1	1617863	1
	5 mm ... 9 mm	1618802	1	1618835	1	1617929	1	1617872	1
	9 mm ... 11 mm	1618805	1	1618836	1	1617932	1	1617873	1
		Accessories				Accessories			
Crimp contacts		For socket contacts, see page 72 onwards				For pin contacts, see page 72 onwards			
Color rings, 50 pcs. in set (to be ordered separately)		See page 164				See page 164			

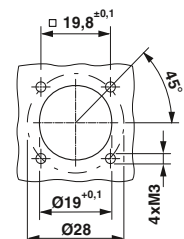
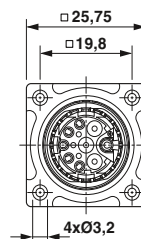
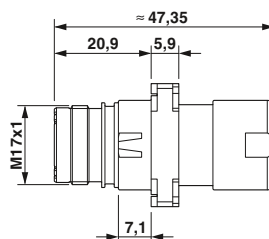

Installation dimensions

M17 Compact device connector, front mounting

- Compatible with mating plugs with SPEEDCON or M17 standard knurled nuts
- Individual marking of connectors with color rings
- **Flange dimensions: 21.6 mm x 21.6 mm**



Device connector, straight, socket assembly



Device connector, straight, pin assembly

Description	Ordering data				Ordering data				
	Order No.	Pcs. / Pkt.	Order No.	Pcs. / Pkt.	Order No.	Pcs. / Pkt.	Order No.	Pcs. / Pkt.	
Device connector, with contact carrier, without contacts, contact insert for support on the device									
		8-pos.		17-pos.		8-pos.		17-pos.	
Device connector, with contact carrier, without contacts, contact insert can be snapped in									
	1619039	1	1607654	1	1613286	1	1607636	1	
	1619038	1	1607653	1	1619037	1	1607634	1	
		Accessories				Accessories			
Crimp contacts	For socket contacts, see page 72 onwards				For pin contacts, see page 72 onwards				
Color rings, 50 pcs. in set (to be ordered separately)	See page 164				See page 164				

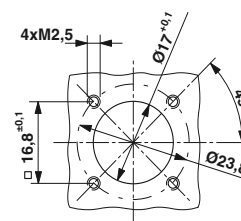
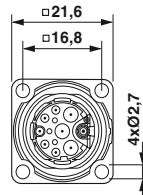
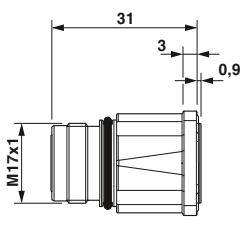

Installation dimensions

Connectors

M17 - signal connectors

Cable connector, SPEEDCON fast locking system

– Individual marking of connectors with color rings



Cable connector, socket assembly



Cable connector, pin assembly

Description	Cable clamping area	Ordering data				Ordering data			
		Order No.	Pcs. / Pkt.	Order No.	Pcs. / Pkt.	Order No.	Pcs. / Pkt.	Order No.	Pcs. / Pkt.
		8-pos.		17-pos.		8-pos.		17-pos.	
Cable connector, with contact carrier, without contacts									
	5 mm ... 8 mm	1619007	1	1607642	1	1618999	1	1607625	1
	8 mm ... 10 mm	1619008	1	1607644	1	1619000	1	1607627	1
	10 mm ... 12.5 mm	1619009	1	1624532	1	1619001	1	1624529	1
Accessories									
Crimp contacts		For socket contacts, see page 72 onwards				For pin contacts, see page 72 onwards			
Color rings, 50 pcs. in set (to be ordered separately)		See page 164				See page 164			

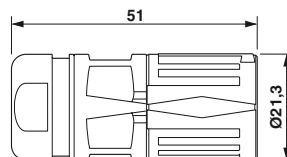

**Cable connector,
M17 standard interlocking**

- Standard knurled nuts compatible with mating plugs with SPEEDCON or M17 standard external thread
- Individual marking of connectors with color rings



Cable connector,
socket assembly



Cable connector,
pin assembly

Description	Cable clamping area	Ordering data				Ordering data			
		Order No.	Pcs. / Pkt.	Order No.	Pcs. / Pkt.	Order No.	Pcs. / Pkt.	Order No.	Pcs. / Pkt.
Cable connector, with contact carrier, without contacts		8-pos.		17-pos.		8-pos.		17-pos.	
	5 mm ... 8 mm	1619003	1	1607641	1	1618995	1	1607624	1
	8 mm ... 10 mm	1619004	1	1607643	1	1618996	1	1607626	1
	10 mm ... 12.5 mm	1619005	1	1624531	1	1618997	1	1624528	1
		Accessories				Accessories			
Crimp contacts		For socket contacts, see page 72 onwards				For pin contacts, see page 72 onwards			
Color rings, 50 pcs. in set (to be ordered separately)		See page 164				See page 164			

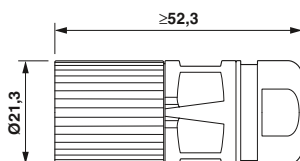

Connectors

M17 - signal connectors

Coupling connector

- Compatible with mating plugs with SPEEDCON or M17 standard knurled nuts
- Individual marking of connectors with color rings



**Coupler connector,
socket assembly**



**Coupler connector,
pin assembly**

Description		Ordering data				Ordering data			
		Order No.	Pcs. / Pkt.	Order No.	Pcs. / Pkt.	Order No.	Pcs. / Pkt.	Order No.	Pcs. / Pkt.
Cable clamping area		8-pos.		17-pos.		8-pos.		17-pos.	
Coupler connector, with contact carrier, without contacts									
	5 mm ... 8 mm	1619015	1	1607647	1	1619011	1	1607630	1
	8 mm ... 10 mm	1619016	1	1607649	1	1619012	1	1607631	1
	10 mm ... 12.5 mm	1619017	1	1624533	1	1619013	1	1624530	1
		Accessories				Accessories			
Crimp contacts		For socket contacts, see page 72 onwards				For pin contacts, see page 72 onwards			
Color rings, 50 pcs. in set (to be ordered separately)		See page 164				See page 164			

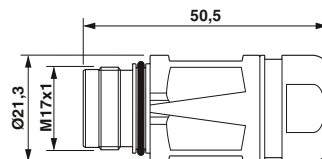

Device connector, straight, front mounting

- Compatible with mating plugs with SPEEDCON or M17 standard knurled nuts
- Contact insert for support on the device or can be snapped in
- Individual marking of connectors with color rings



Device connector, straight, socket assembly



Device connector, straight, pin assembly

Description	Ordering data				Ordering data			
	Order No.	Pcs. / Pkt.	Order No.	Pcs. / Pkt.	Order No.	Pcs. / Pkt.	Order No.	Pcs. / Pkt.
Device connector , with contact carrier, without contacts, contact insert for support on the device								
Flange dimensions: 25.75 mm x 25.75 mm	1619197	1	1619206	1	1619196	1	1619202	1
Device connector , with contact carrier, without contacts, contact insert can be snapped in								
Flange dimensions: 25.75 mm x 25.75 mm	1619220	1	1619226	1	1619219	1	1619225	1
	Accessories				Accessories			
Crimp contacts	For socket contacts, see page 72 onwards				For pin contacts, see page 72 onwards			
Color rings, 50 pcs. in set (to be ordered separately)	See page 164				See page 164			

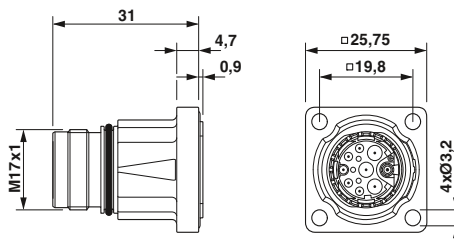

Contact insert for support on the device

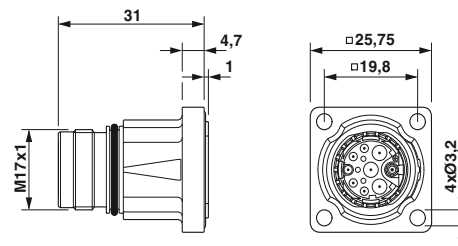

Contact insert can be snapped in

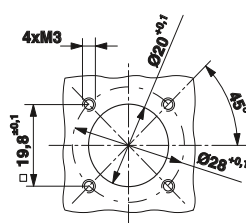

Installation dimensions

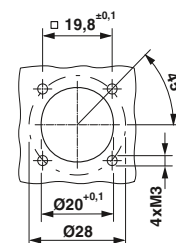

Installation dimensions

Connectors

M17 - signal connectors

Device connector, angled, rotatable, front mounting

- Compatible with mating plugs with SPEEDCON or M17 standard knurled nuts
- Housing can be freely rotated up to 308°
- Individual marking of connectors with color rings
- Flange versions for M2.5/M3 attachment



Device connector, angled, rotatable, for socket contacts



Device connector, angled, rotatable, for pin contacts

Description	Ordering data				Ordering data			
	Order No.	Pcs. / Pkt.	Order No.	Pcs. / Pkt.	Order No.	Pcs. / Pkt.	Order No.	Pcs. / Pkt.
Device connector, angled, rotatable, with contact carrier, without contacts Fixing with M2.5	1620440	1	1620442	1	1620439	1	1620441	1
Device connector, angled, rotatable, with contact carrier, without contacts Fixing with M3	1620455	1	1620457	1	1620456	1	1620458	1
	Accessories				Accessories			
Crimp contacts Color rings, 50 pcs. in set (to be ordered separately)	For socket contacts, see page 72 onwards See page 164				For pin contacts, see page 72 onwards See page 164			

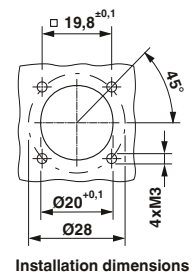
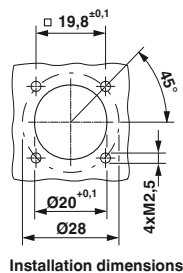
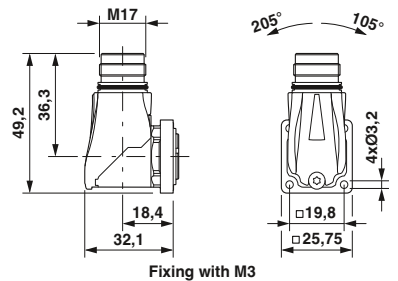
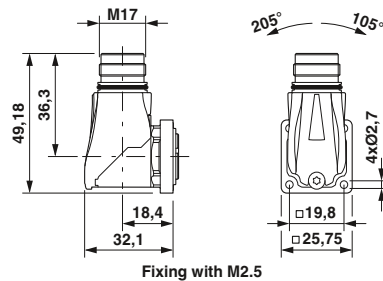

Device connector, central fastening thread, front/rear mounting

- Compatible with mating plugs with SPEEDCON or M17 standard knurled nuts
- Snapping in the contact carriers from the device side
- Individual marking of connectors with color rings



Device connector, central fixing, socket assembly



Device connector, central fixing, pin assembly

Ordering data			
Order No.	Pcs. / Pkt.	Order No.	Pcs. / Pkt.
	8-pos.		17-pos.

1619036	1	1613542	1
1619035	1	1613543	1

Ordering data			
Order No.	Pcs. / Pkt.	Order No.	Pcs. / Pkt.
	8-pos.		17-pos.

1618584	1	1613540	1
1619034	1	1613541	1

Accessories			
Type	Order No.	Pcs. / Pkt.	
ST-E2015151	1613831	10	
RC-13041	1600417	10	

For socket contacts, see page 72 onwards
See page 164

Accessories			
Type	Order No.	Pcs. / Pkt.	
ST-E2015151	1613831	10	
RC-13041	1600417	10	

For pin contacts, see page 72 onwards
See page 164

Description
Device connector, front mounting , M18 x 0.75 fastening thread, with contact carrier, without contacts
Device connector, rear mounting , M20 x 1.5 fastening thread, with contact carrier, without contacts

Description
Locking nut , for mounting bore holes and polarization
M18 x 0.75
M20 x 1.5
Crimp contacts
Color rings, 50 pcs. in set (to be ordered separately)

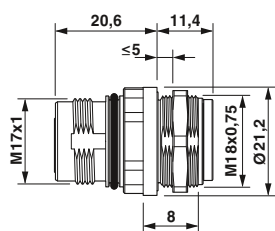

Front mounting, M18 x 0.75, order locking nut separately

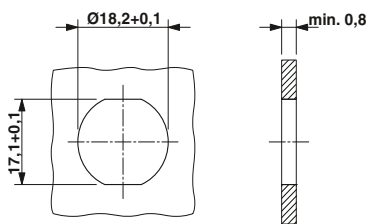

Installation dimensions: mounting with anti-rotation protection and locking nut

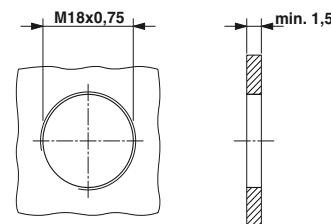

Installation dimensions: mounting with thread

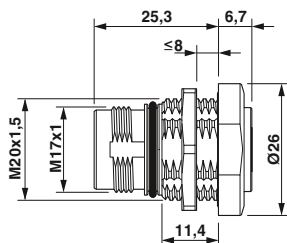

Rear mounting, M20 x 1.5, order locking nut separately

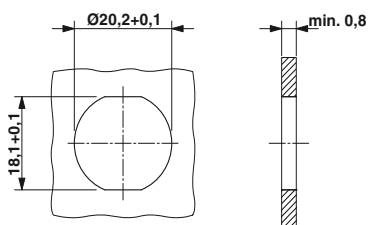

Installation dimensions: mounting with anti-rotation protection and locking nut

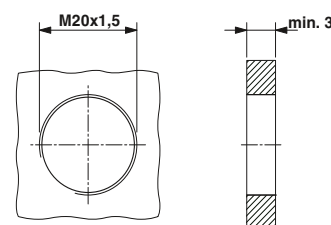

Installation dimensions: mounting with thread

Connectors

M17 - signal connectors

Crimp contacts, punched-rolled

C-HC® are punched-rolled contacts. They are designed for high insertion/withdrawal cycles.

The contacts are available taped on rolls for manual or automatic processing.

Note: depending on the litz wire used, the connection cross sections (crimp ranges) may deviate from the listed values. For reasons of safety, only socket contacts may be used in the live part of the connector.



C-HC socket contacts



C-HC pin contacts

		Ordering data			Ordering data		
Description	Connection cross section [mm ²]	Type	Order No.	Pcs. / Pkt.	Type	Order No.	Pcs. / Pkt.
Crimp contacts, C-HC punched-rolled, Ø 1.0 mm, 2500 pcs./roll							
	0.06 mm ² ... 0.25 mm ²	SF-10KS320	1607031	1	SF-10KP320	1615961	1
	0.2 mm ² ... 0.56 mm ²	SF-10KS350	1607032	1	SF-10KP350	1615963	1
Crimp contact C-HC punched-rolled, Ø 1.0 mm, 10,000 pcs./roll							
	0.06 mm ² ... 0.25 mm ²	SF-10KS330	1607358	1	SF-10KP330	1615962	1
	0.2 mm ² ... 0.56 mm ²	SF-10KS360	1607361	1	SF-10KP360	1615964	1
		Accessories			Accessories		
Crimping tools		Order separately, see page 158			Order separately, see page 158		

Crimp contacts, turned

M17 signal connectors are fitted with

contacts with \varnothing 1.0 mm or \varnothing 0.6 mm depending on the number of positions.

– 8-pos. versions: contacts with \varnothing 1.0 mm

– 17-pos. versions: contacts with \varnothing 0.6 mm

Note:

Depending on the litz wire used, the connection cross sections (crimp ranges) can differ from the values mentioned below.



Crimp contacts, socket



Crimp contacts, pin

		Ordering data			Ordering data		
Description	Connection cross section [mm ²]	Type	Order No.	Pcs. / Pkt.	Type	Order No.	Pcs. / Pkt.
Contact socket \varnothing 0.6 mm	0.06 mm ² ... 0.25 mm ²	ST-06KS010	1607580	100			
	0.14 mm ² ... 0.34 mm ²	ST-06KS020	1607581	100			
	0.34 mm ² ... 0.50 mm ²	ST-06KS030	1607582	100			
Contacts, \varnothing 1.0 mm	0.06 mm ² ... 0.25 mm ²	ST-10KS010	1618239	100			
	0.34 mm ² ... 0.5 mm ²	ST-10KS020	1618251	100			
	0.5 mm ² ... 1.0 mm ²	ST-10KS030	1618254	100			
Contact pin \varnothing 0.6 mm	0.06 mm ² ... 0.25 mm ²				ST-06KP010	1607577	100
	0.14 mm ² ... 0.34 mm ²				ST-06KP020	1607578	100
	0.34 mm ² ... 0.50 mm ²				ST-06KP030	1607579	100
Contacts, \varnothing 1.0 mm	0.06 mm ² ... 0.25 mm ²				ST-10KP010	1618255	100
	0.34 mm ² ... 0.5 mm ²				ST-10KP020	1618256	100
	0.5 mm ² ... 1.0 mm ²				ST-10KP030	1618261	100
		Accessories			Accessories		
Crimping tools		Order separately, see page 159			Order separately, see page 159		

Notes:

Every connector housing type can be equipped with pin or socket contacts.

For reasons pertaining to safety, only socket contacts may be used in the live part of the connector.

Mechanical and electrical data

Mechanical data	
Housing material:	Copper zinc alloy (CuZn), die-cast zinc (GD-Zn)
Housing surface:	Nickel-plated/thick layer passivated (can be coated)
Insulating body:	Thermoplastic polyester (PBT), polyamide (PA 66)
Contact material:	Copper zinc alloy (CuZn)
Contact surface:	Nickel-plated (Ni) with gold coating (Au)
Contact connection method:	Solder cup, crimp, solder-in pin
Sealing and O-ring:	NBR
Flat gasket:	NBR, fiber-reinforced NBR
Temperature range:	-40°C ... +125°C
Cable entry:	Cable and coupler connectors for a cable outside diameter of 3 - 14.5 mm, shielded
Type of locking:	M23 SPEEDCON fast locking system, cable connector with M23 x 1 coarse-pitch thread as an option
Mech. insertion/withdrawal cycles:	Standard: 100, punched-rolled C-HC crimp contacts: up to 500
Protection class:	IP67 when locked

Electrical data									
Number of positions	6	7	9 (8+1)		12	16	17	19 (16+3)	
Contacts	6	7	8 + 1		12	12	17	16 + 3	
Contact Ø [mm]	2	2	1 2		1	1	1	1 1.5	
Litz wire cross section									
Solder connection: contacts x [mm ²] max.	6 x 2.5	7 x 2.5	8 x 1.0 + 1 x 2.5		12 x 1.0	16 x 1.0	17 x 1.0	16 x 1.0 + 3 x 1.0	
Crimp connection: contacts x [mm ²] max.	6 x 2.5	7 x 2.5	8 x 0.56 + 1 x 2.5		12 x 0.56	16 x 0.56	17 x 0.56	16 x 1.0 + 3 x 1.0	
Nominal current per contact at 25°C ¹⁾	20	20	8 20		8	8	8	8 10	
Specifications according to DIN EN 61984:2009									
Rated voltage [V AC/DC]	300	300	300		150	150	150	150	
Test/surge voltage [kV AC]	2.5	2.5	2.5		1.5	1.5	1.5	1.5	
Surge voltage category	II	II	II		II	II	II	II	
Pollution degree ²⁾	3	3	3		3	3	3	3	
Installation height [m]	Up to 2000	Up to 2000	Up to 2000		Up to 2000	Up to 2000	Up to 2000	Up to 2000	
Cable clamping area ³⁾ Max. Ø [mm]	14.5	14.5	14.5		14.5	14.5	14.5	14.5	

¹⁾ The effective current carrying capacity must be determined using a derating curve, if necessary, according to the application.

²⁾ The values specified assume that the connector pair is correctly locked and is only disconnected for testing and maintenance purposes. If the connector is unlocked and exposed to ambient conditions, and if there is a danger of pollution, the connector must be sealed using a protective cap ≥ IP54.

³⁾ The cable clamping areas specified on the following pages may vary depending on the cable material/structure. Selection and testing is the responsibility of the user.

Note:
Unlike plug-in devices, connectors may only be inserted or removed when disconnected from the power.

Contact chamber numbering
(view of plug-in side)

Direction of rotation for contact chamber numbering
(view of plug-in side)

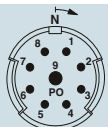

Forward running (standard)

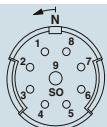

Reverse running (standard)

Number of positions

Pin

Socket

6-pos.

Solder/crimp/solder-in

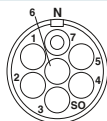
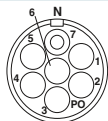

7-pos.

Solder/crimp/solder-in

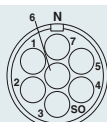
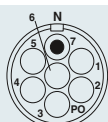

9-pos. (8+1)

Solder/crimp/solder-in

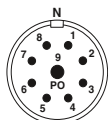

12-pos.

Solder/crimp/solder-in



16-pos.

Solder/crimp/solder-in

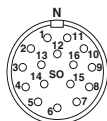
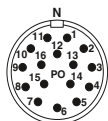

17-pos.

Solder/crimp/solder-in

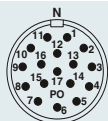

19-pos. (16+3)

Solder/crimp

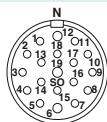
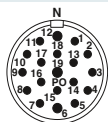

Note:

The connectors can be fitted with pin or socket contacts according to the application.

For safety reasons, only socket contacts may be used in the live part of the connector.

Connectors

M23 - signal connectors

Selection guide

M23 signal connectors
6- to 19-pos., up to 20 A/300 V, solder,
crimp, and solder-in connection.

- Cable connectors
- Coupler connectors
- Device connectors (device flanges)

In the case of crimp connection, the
respective crimp contacts must be added
depending on the connection cross
section.

Each housing type can be fitted with pin
or socket contacts. The product chart
provides an overview of the available
components.

Connector type

Cable connectors

SPEEDCON fast locking system,
see page 78.

M23 x 1 standard interlocking,
see page 79.

Shielded



Coupler connectors

See page 80.

Shielded



Device connectors

Front mounting,
Pg13.5 fastening thread,
see page 81.

Front mounting,
M20 fastening thread,
see phoenixcontact.net/products



Front mounting,
flange dimensions: 25 mm x 25 mm,
see page 83.

Front mounting, solder-in connection,
flange dimensions: 25 mm x 25 mm,
see phoenixcontact.net/products



Shielded

Front mounting,
angled, rotatable,
flange dimensions: 26 mm x 26 mm,
see page 84.



Rear mounting,
central fastening nut,
see page 85.



For crimp connection:

Socket contacts

Turned, see page 86.



Rolled, taped,
see page 86.



Pin contacts

Turned, see page 86.

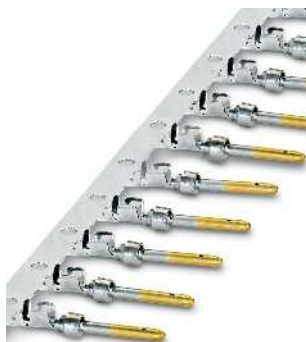

Rolled, taped,
see page 86.

**Note:**

For safety reasons, only socket contacts may be used in the live part of the connector.

Tools/accessories

Crimping tools

Crimping pliers for rolled crimp contacts,
see page 156.



Crimping pliers with digital display for turned crimp contacts,
see page 156.



Tools/accessories

Unlocking tool for device connectors for releasing the contact carriers from the plug-in side,
see page 162.



Color rings for individually marking the connectors,
see page 164.



All housings can be fitted with pin or socket crimp contacts

Connectors

M23 - signal connectors

Cable connector, SPEEDCON fast locking system

- 6 to 19-pos. versions, solder/crimp connection
- Individual marking of connectors with color rings



6, 7, 8+1-pos.



12, 17, 16+3-pos.

Description	Cable clamping area	Ordering data					
		Order No.	Pcs. / Pkt.	Order No.	Pcs. / Pkt.	Order No.	Pcs. / Pkt.
Cable connector, with contact carrier, with socket contacts, solder connection							
Universal gasket	3 mm ... 14.5 mm	1619605	1	1619601	1	1619597	1
	4 mm ... 6 mm	1619579	1	1619575	1	1619571	1
	6 mm ... 10 mm	1619534	1	1619530	1	1619526	1
	10 mm ... 14.5 mm	1619508	1	1619504	1	1619500	1
Cable connector, with contact carrier, with pin contacts, solder connection							
Universal gasket	3 mm ... 14.5 mm	1619604	1	1619600	1	1619596	1
	4 mm ... 6 mm	1619578	1	1619574	1	1619570	1
	6 mm ... 10 mm	1619533	1	1619529	1	1619525	1
	10 mm ... 14.5 mm	1619507	1	1619503	1	1619499	1
Cable connector, with contact carrier, without contacts, for socket assembly, crimp connection							
Universal gasket	3 mm ... 14.5 mm	1619603	1	1619599	1	1619595	1
	4 mm ... 6 mm	1619577	1	1619573	1	1619569	1
	6 mm ... 10 mm	1619532	1	1619528	1	1619524	1
	10 mm ... 14.5 mm	1619506	1	1619502	1	1619498	1
Cable connector, with contact carrier, without contacts, for pin assembly, crimp connection							
Universal gasket	3 mm ... 14.5 mm	1619602	1	1619598	1	1619594	1
	4 mm ... 6 mm	1619576	1	1619572	1	1619568	1
	6 mm ... 10 mm	1619531	1	1619527	1	1619523	1
	10 mm ... 14.5 mm	1619505	1	1619501	1	1619497	1
		Accessories					
For crimp connection: crimp contacts		Order separately, see page 86 onwards					
Color rings, 50 pcs. in set (to be ordered separately)		See page 164					

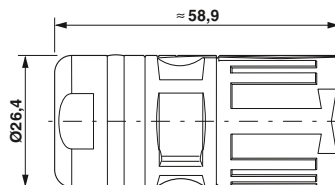

Cable connector, M23 standard interlocking

- Standard knurled nuts compatible with mating plugs with SPEEDCON or M23 standard external thread
- 6 to 19-pos. versions, solder/crimp connection
- Individual marking of connectors with color rings



6, 7, 8+1-pos.



12, 17, 16+3-pos.

Description	Cable clamping area	Ordering data			Ordering data		
		Order No.	Pcs. / Pkt.	Order No.	Pcs. / Pkt.	Order No.	Pcs. / Pkt.
Cable connector, with contact carrier, with socket contacts, solder connection							
Universal gasket	3 mm ... 14.5 mm	1619776	1	1619772	1	1619768	1
	4 mm ... 6 mm	1619750	1	1619746	1	1619742	1
	6 mm ... 10 mm	1619724	1	1619720	1	1619716	1
	10 mm ... 14.5 mm	1619659	1	1619655	1	1619651	1
Cable connector, with contact carrier, with pin contacts, solder connection							
Universal gasket	3 mm ... 14.5 mm	1619775	1	1619771	1	1619767	1
	4 mm ... 6 mm	1619749	1	1619745	1	1619741	1
	6 mm ... 10 mm	1619723	1	1619719	1	1619715	1
	10 mm ... 14.5 mm	1619658	1	1619654	1	1619650	1
Cable connector, with contact carrier, without contacts, for socket assembly, crimp connection							
Universal gasket	3 mm ... 14.5 mm	1619774	1	1619770	1	1619766	1
	4 mm ... 6 mm	1619748	1	1619744	1	1619740	1
	6 mm ... 10 mm	1619722	1	1619718	1	1619714	1
	10 mm ... 14.5 mm	1619657	1	1619653	1	1619649	1
Cable connector, with contact carrier, without contacts, for pin assembly, crimp connection							
Universal gasket	3 mm ... 14.5 mm	1619773	1	1619769	1	1619765	1
	4 mm ... 6 mm	1619747	1	1619743	1	1619739	1
	6 mm ... 10 mm	1619721	1	1619717	1	1619711	1
	10 mm ... 14.5 mm	1619656	1	1619652	1	1619648	1
		Accessories			Accessories		
For crimp connection: crimp contacts		Order separately, see page 86 onwards			Order separately, see page 86 onwards		
Color rings, 50 pcs. in set (to be ordered separately)		See page 164			See page 164		

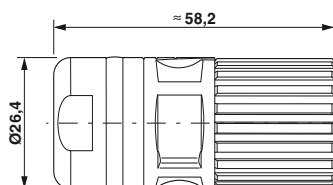

Device connector, front mounting

- **Flange dimensions: 25 mm x 25 mm**
- Compatible with mating plugs with SPEEDCON or M23 standard knurled nuts
- 6 to 19-pos. versions, solder/crimp connection
- Individual marking of connectors with color rings



6, 7, 8+1-pos.



12, 17, 16+3-pos.

Description	Ordering data			Ordering data		
	Order No.	Pcs. / Pkt.	Order No.	Pcs. / Pkt.	Order No.	Pcs. / Pkt.
Device connector, with contact carrier, with socket contacts , solder connection, flat gasket	6-pos.		7-pos.		12-pos.	
Device connector, with contact carrier, with pin contacts , solder connection, flat gasket					17-pos.	
Device connector, with contact carrier, without contacts, for socket assembly , crimp connection, flat gasket						16+3-pos.
Device connector, with contact carrier, without contacts, for pin assembly , crimp connection, flat gasket						
For crimp connection: crimp contacts Color rings, 50 pcs. in set (to be ordered separately)	Accessories			Accessories		
	Order separately, see page 86 onwards See page 164			Order separately, see page 86 onwards See page 164		

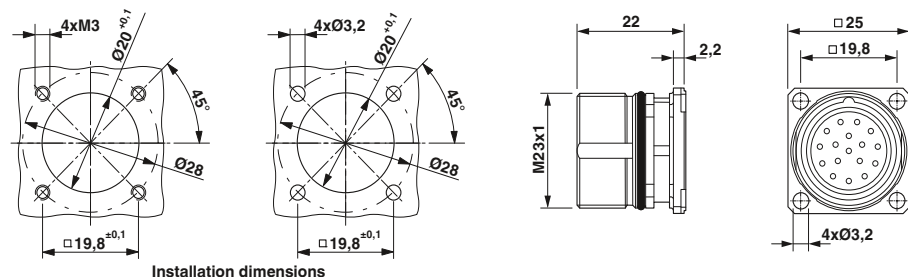

**Device connector,
rear mounting**

- Compatible with mating plugs with SPEEDCON or M23 standard knurled nuts
- 6 to 19-pos. versions, solder/crimp connection
- Individual marking of connectors with color rings



6, 7, 8+1-pos.



12, 17, 16+3-pos.

Description	Ordering data			Ordering data		
	Order No.	Pcs. / Pkt.	Order No.	Pcs. / Pkt.	Order No.	Pcs. / Pkt.
Device connector, with contact carrier, with socket contacts, solder connection, central fixing nut, axial seal	6-pos.		7-pos.		12-pos.	
	1619851	1	1619847	1	1619790	1
Device connector, with contact carrier, with pin contacts, solder connection, central fixing nut, axial seal					17-pos.	
	1619850	1	1619846	1	1619782	1
Device connector, with contact carrier, without contacts, for socket assembly, crimp connection, central fixing nut, axial seal					16+3-pos.	
	1619849	1	1619845	1	1619788	1
Device connector, with contact carrier, without contacts, for pin assembly, crimp connection, central fixing nut, axial seal						
	1619848	1	1619844	1	1619787	1
Accessories			Accessories			
For crimp connection: crimp contacts	Order separately, see page 86 onwards			Order separately, see page 86 onwards		
Color rings, 50 pcs. in set (to be ordered separately)	See page 164			See page 164		

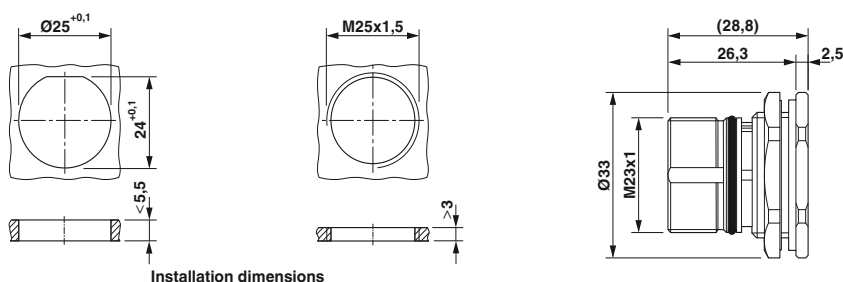

Connectors

M23 - signal connectors

Crimp contacts

Pin and socket crimp contacts with various connection cross sections can be ordered for each crimp contact carrier.



Rolled crimp contacts



Turned crimp contacts

		Ordering data			Ordering data		
Description	Contacts / connection cross section [mm ²]	Type	Order No.	Pcs. / Pkt.	Type	Order No.	Pcs. / Pkt.
Crimp contacts for contact carriers, 6-pos., 6 x Ø2.0 mm	Pin Ø 2.0 mm / 1.0 ... 1.5				RC-5CP2000	1603513	50
	Socket Ø 2.0 mm / 1.0 ... 1.5				RC-5CS2000	1603517	50
	Pin Ø 2.0 mm / 1.5 ... 2.5				RC-5AP2000	1603505	50
	Socket Ø 2.0 mm / 1.5 ... 2.5				RC-5AS2000	1603509	50
Crimp contacts for contact carriers, 7-pos., 7 x Ø2.0 mm	Pin Ø 2.0 mm / 1.0 ... 1.5				RC-5CP2000	1603513	50
	Socket Ø 2.0 mm / 1.0 ... 1.5				RC-5CS2000	1603517	50
	Pin Ø 2.0 mm / 1.5 ... 2.5				RC-5AP2000	1603505	50
	Socket Ø 2.0 mm / 1.5 ... 2.5				RC-5AS2000	1603509	50
Crimp contacts for contact carriers, 9-pos. (8+1), 8 x Ø1.0 mm, 1 x Ø2.0 mm	Pin Ø1.0 mm / 0.14 ... 0.56				RC-12P2000	1597862	100
	Socket Ø1.0 mm / 0.14 ... 0.56				RC-12S2000	1599600	100
	Pin Ø 2.0 mm / 1.5 ... 2.5				RC-5AP2000	1603505	50
	Socket Ø 2.0 mm / 1.5 ... 2.5				RC-5AS2000	1603509	50
	Pin Ø 2.0 mm / 1.0 ... 1.5				RC-5CP2000	1603513	50
	Socket Ø 2.0 mm / 1.0 ... 1.5				RC-5CS2000	1603517	50
Crimp contacts for contact carriers, 12-pos., 12 x Ø1.0 mm	Pin Ø1.0 mm / 0.22 ... 0.56	RC-22P2000	1603321	100			
	Socket Ø1.0 mm / 0.22 ... 0.56	RC-22S2000	1603327	100			
	Pin Ø1.0 mm / 0.14 ... 0.56				RC-12P2000	1597862	100
	Socket Ø1.0 mm / 0.14 ... 0.56				RC-12S2000	1599600	100
Crimp contacts for contact carriers, 16-pos., 16 x Ø1.0 mm	Pin Ø1.0 mm / 0.22 ... 0.56	RC-22P2000	1603321	100			
	Socket Ø1.0 mm / 0.22 ... 0.56	RC-22S2000	1603327	100			
	Pin Ø1.0 mm / 0.14 ... 0.56				RC-12P2000	1597862	100
	Socket Ø1.0 mm / 0.14 ... 0.56				RC-12S2000	1599600	100
		Accessories			Accessories		
Crimping tools		See page 156			See page 156		

Mechanical and electrical data

Mechanical data	
Housing material:	Copper zinc alloy (CuZn), die-cast zinc (GD-Zn)
Housing surface:	Nickel-plated/thick layer passivated (can be coated)
Insulating body:	Polyamide (PA 66)
Contact material:	Copper zinc alloy (CuZn)
Contact surface:	Nickel-plated (Ni) with gold coating (Au)
Contact connection method:	Crimp version
Sealing and O-ring:	Fluorocarbon rubber (FKM)
Ambient temperature:	-40°C ... 125°C
Cable entry:	Cable and coupler connectors for a cable outside diameter of 3 ... 14.5 mm, shielded
Type of locking:	M23 SPEEDCON screw locking, cable connector with M23 x 1 coarse-pitch thread as an option
Mech. insertion/withdrawal cycles:	Standard: 100, punched-rolled C-HC crimp contacts: up to 500
Protection class:	IP67 when locked

Electrical data			
Number of positions		12	17
Contacts		12	17
Contact Ø	[mm]	1	1
Litz wire cross section, crimp contacts turned	[mm ²]	0.08 ... 1.0	0.08 ... 1.0
Litz wire cross section, C-HC crimp contacts punched-rolled	[mm ²]	0.06 ... 0.56	0.06 ... 0.56
Cable clamping area	Max. Ø [mm]	14.5	14.5
Nominal current per contact at 25°C ¹⁾	[A]	8	8
Specifications according to DIN EN 61984:2009			
Rated voltage	[V AC/DC]	150	100
Test/surge voltage	[kV]	2.5	1.5
Surge voltage category		III	III
Pollution degree ²⁾		3	3
Installation height	[m]	Up to 3000	Up to 3000
Cable clamping area ³⁾	Max. Ø [mm]	14.5	14.5

¹⁾ The effective current carrying capacity must be determined using a derating curve, if necessary, according to the application.

²⁾ The values specified assume that the connector pair is correctly locked and is only disconnected for testing and maintenance purposes. If the connector is unlocked and exposed to ambient conditions, and if there is a danger of pollution, the connector must be sealed using a protective cap ≥ IP54.

³⁾ The cable clamping areas specified on the following pages may vary depending on the cable material/structure. Selection and testing is the responsibility of the user.

Note:
Unlike plug-in devices, connectors may only be inserted or removed when disconnected from the power.

Contact chamber numbering (view of plug-in side)				
Direction of rotation for contact chamber numbering (view of plug-in side)				
	Forward running (standard) R marked	Reverse running (standard) L marked	Reverse running (counter direction) L marked	Forward running (counter direction) R marked
Number of positions	Pin	Socket	Pin	Socket
12-pos. N-coding Crimp				
17-pos. N-coding Crimp				

Note:
Standard coding is "N". Other codings and numbers of positions available on request.

The connectors can be fitted with pin or socket contacts according to the application.

For safety reasons, only socket contacts may be used in the live part of the connector.

Connectors

M23 - feedback connectors

Selection guide

M23 signal connectors
12/17-pos., N-coding, up to 8 A/150 V,
crimp ranges up to 1 mm²

- Cable connectors
- Coupler connectors
- Device connectors (device flanges)

Crimp contacts must be ordered separately depending on the connection cross section.

Each housing type can be fitted with pin or socket contacts.

The connectors can be supplied with clockwise or counter-clockwise contact chamber numbering.

N (0°) and S (20°, on request) coding positions are possible.

The product chart provides an overview of the available components.

Connector type

Cable connectors

SPEEDCON fast locking system, see page 92.

M23 x 1 standard interlocking, see page 93.

Shielded



Square mounting flange for cable and coupler connectors for wall mounting, see page 162.

Coupler connectors

See page 94.

Shielded



Square mounting flange for cable and coupler connectors for wall mounting, see page 162.

Device connectors

Straight, 4-hole mounting
Ø 3.2,
see page 96.



Contact carrier for snapping in from the device side,
straight, 4-hole mounting
Ø 3.2, see page 96.



Shielded

Angled, rotatable,
flange dimensions: 26 mm x 26 mm,
see page 97.



Angled, rotatable,
flange dimensions: 28 mm x 28 mm,
see page 97.



Crimp contacts

Socket contacts

Turned, see page 99.



Punched-rolled, taped,
see page 98.



All housings can be fitted with pin or socket crimp contacts

Pin contacts

Turned, see page 99.



Punched-rolled, taped,
see page 98.



Tools/accessories

Crimping tools

Crimping pliers for punched-rolled
C-HC crimp contacts,
see page 158.



Crimping pliers with digital display for turned
crimp contacts,
see page 159.



Tools/accessories

Unlocking tool for device connectors with contact
carriers for snapping in from the device side,
see page 162.



Color rings for individually marking the connectors,
see page 164.

**Note:**

For safety reasons, only socket contacts may
be used in the live part of the connector.

Connectors

M23 - feedback connectors

Cable connector, SPEEDCON fast locking system

- 12 or 17-pos. versions
- Individual marking of connectors with color rings



Cable connector, socket assembly



Cable connector, pin assembly

Description	Cable clamping area	Ordering data				Ordering data			
		Order No.	Pcs. / Pkt.	Order No.	Pcs. / Pkt.	Order No.	Pcs. / Pkt.	Order No.	Pcs. / Pkt.
Cable connector, with contact carrier, without contacts, standard direction of rotation									
Universal gasket	3 mm ... 14.5 mm	1619472	1	1619470	1	1619471	1	1619469	1
	4 mm ... 6 mm	1619466	1	1619464	1	1619465	1	1619463	1
	6 mm ... 10 mm	1619460	1	1619458	1	1619459	1	1619457	1
	10 mm ... 14.5 mm	1619454	1	1619452	1	1619453	1	1619451	1
Cable connector, with contact carrier, without contacts, reverse direction of rotation									
Universal gasket	3 mm ... 14.5 mm	1619474	1			1619473	1		
	4 mm ... 6 mm	1619468	1			1619467	1		
	6 mm ... 10 mm	1619462	1			1619461	1		
	10 mm ... 14.5 mm	1619456	1			1619455	1		
		Accessories				Accessories			
Crimp contacts		For socket contacts, see page 98 onwards				For pin contacts, see page 98 onwards			
Color rings, 50 pcs. in set (to be ordered separately)		See page 164				See page 164			

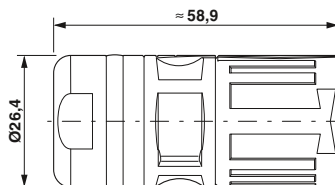

Cable connector, M23 standard interlocking

- M23 standard knurled nut
- 12 or 17-pos. versions
- Individual marking of connectors with color rings



Cable connector, socket assembly



Cable connector, pin assembly

Description	Cable clamping area	Ordering data				Ordering data			
		Order No.	Pcs. / Pkt.	Order No.	Pcs. / Pkt.	Order No.	Pcs. / Pkt.	Order No.	Pcs. / Pkt.
		12-pos.		17-pos.		12-pos.		17-pos.	
Cable connector housing, with contact carrier, without contacts, standard direction of rotation									
Universal gasket	3 mm ... 14.5 mm	1619631	1	1619629	1	1619630	1	1619628	1
	4 mm ... 6 mm	1619625	1	1619623	1	1619624	1	1619619	1
	6 mm ... 10 mm	1619616	1	1619614	1	1619615	1	1619613	1
	10 mm ... 14.5 mm	1619610	1	1619608	1	1619609	1	1619607	1
Cable connector housing, with contact carrier, without contacts, reverse direction of rotation									
Universal gasket	3 mm ... 14.5 mm	1619633	1			1619632	1		
	4 mm ... 6 mm	1619627	1			1619626	1		
	6 mm ... 10 mm	1619618	1			1619617	1		
	10 mm ... 14.5 mm	1619612	1			1619611	1		
		Accessories				Accessories			
Crimp contacts		For socket contacts, see page 98 onwards				For pin contacts, see page 98 onwards			
Color rings, 50 pcs. in set (to be ordered separately)		See page 164				See page 164			

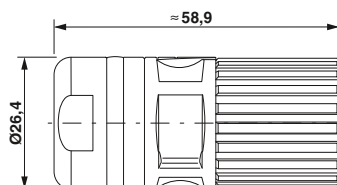

Connectors

M23 - feedback connectors

Device connector, straight, front mounting

- Compatible with mating plugs with SPEEDCON or M23 standard knurled nuts
- Contact insert for support on the device or can be snapped in



Device connector, straight, socket assembly



Device connector, straight, pin assembly

Description	Ordering data				Ordering data			
	Order No.	Pcs. / Pkt.	Order No.	Pcs. / Pkt.	Order No.	Pcs. / Pkt.	Order No.	Pcs. / Pkt.
Device connector, straight, with contact carrier, without contacts, 4-hole fastening with Ø 3.2 mm								
Standard direction of rotation	1607283	1	1607892	1	1607236	1	1607860	1
Reverse direction of rotation	1607307	1			1607260	1		
Device connector, straight, with contact carrier, without contacts, 4-hole fastening with Ø 3.2 mm, contact insert can be snapped in								
Standard direction of rotation	1607830	1	1607893	1	1607804	1	1607863	1
Reverse direction of rotation	1607844	1			1607817	1		
Accessories				Accessories				
Crimp contacts	For socket contacts, see page 98 onwards				For pin contacts, see page 98 onwards			
Color rings, 50 pcs. in set (to be ordered separately)	See page 164				See page 164			

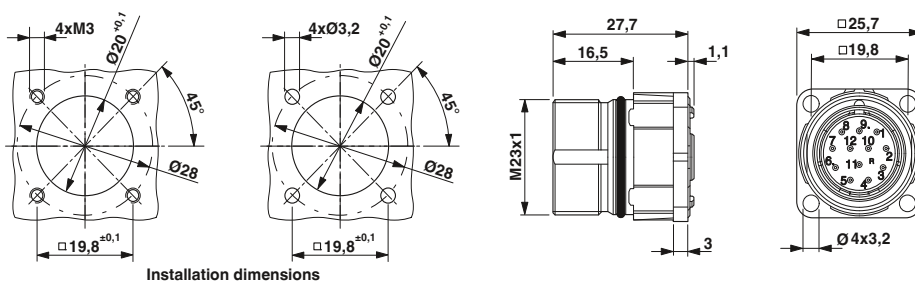

Device connector, angled, rotatable, front mounting

- Compatible with mating plugs with SPEEDCON or M23 standard knurled nuts
- **Flange dimensions:**
26 mm x 26 mm or 28 mm x 28 mm



Device connector, angled, rotatable, for socket contacts



Device connector, angled, rotatable, for pin contacts

Description	Ordering data				Ordering data			
	Order No.	Pcs. / Pkt.	Order No.	Pcs. / Pkt.	Order No.	Pcs. / Pkt.	Order No.	Pcs. / Pkt.
Device connector, angled, rotatable, with contact carrier, without contacts, flange dimensions: 26 mm x 26 mm								
Standard direction of rotation	1607280	1	1607345	1	1607233	16	1607328	1
Reverse direction of rotation	1607304	1			1607257	1		
Device connector, angled, rotatable, with contact carrier, without contacts, flange dimensions: 28 mm x 28 mm								
Standard direction of rotation	1607827	1	1607887	1	1607802	1	1607852	1
Reverse direction of rotation	1607842	1			1607814	1		
	Accessories				Accessories			
Crimp contacts	For socket contacts, see page 98 onwards				For pin contacts, see page 98 onwards			
Color rings, 50 pcs. in set (to be ordered separately)	See page 164				See page 164			

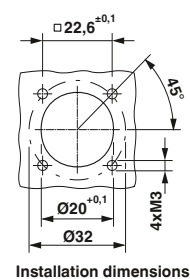
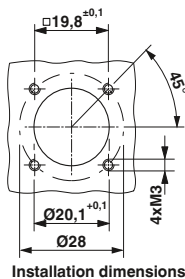
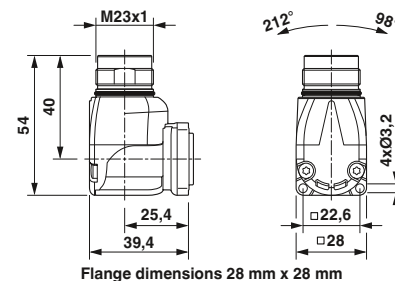
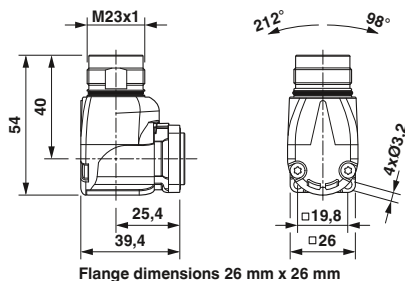

Connectors

M23 - feedback connectors

Crimp contacts, punched-rolled

C-HC® are punched-rolled contacts. They are designed for high insertion/withdrawal cycles.

The contacts are available taped on rolls for manual or automatic processing.

Note: depending on the litz wire used, the connection cross sections (crimp ranges) may deviate from the listed values. For reasons of safety, only socket contacts may be used in the live part of the connector.



C-HC socket contacts



C-HC pin contacts

		Ordering data			Ordering data		
Description	Connection cross section [mm ²]	Type	Order No.	Pcs. / Pkt.	Type	Order No.	Pcs. / Pkt.
Crimp contacts, C-HC punched-rolled, Ø 1.0 mm, 2500 pcs./roll							
	0.06 mm ² ... 0.25 mm ²	SF-10KS320	1607031	1	SF-10KP320	1615961	1
	0.2 mm ² ... 0.56 mm ²	SF-10KS350	1607032	1	SF-10KP350	1615963	1
Crimp contact C-HC punched-rolled, Ø 1.0 mm, 10,000 pcs./roll							
	0.06 mm ² ... 0.25 mm ²	SF-10KS330	1607358	1	SF-10KP330	1615962	1
	0.2 mm ² ... 0.56 mm ²	SF-10KS360	1607361	1	SF-10KP360	1615964	1
		Accessories			Accessories		
Crimping tools		Order separately, see page 158 onwards			Order separately, see page 158 onwards		

Crimp contacts, turned

M23 feedback connectors are fitted with 12 or 17 SF series signal contacts with \varnothing 1 mm depending on the number of positions.

These contacts are also used with M23 power connectors as signal contacts. This simplifies handling and warehousing considerably.

Note: depending on the litz wire used, the connection cross sections (crimp ranges) can differ from the values mentioned below.



Crimp contacts socket



Crimp contacts pin

		Ordering data			Ordering data		
Description	Connection cross section [mm ²]	Type	Order No.	Pcs. / Pkt.	Type	Order No.	Pcs. / Pkt.
Contact socket \varnothing 1.0 mm	0.06 ... 0.2	SF-6CS2000	1605562	100			
	0.14 ... 0.5	SF-10KS004	1607356	100			
	0.5 ... 1.0	SF-6AS2000	1605557	100			
Contact pin \varnothing 1.0 mm	0.06 ... 0.2				SF-6CP2000	1605559	100
	0.14 ... 0.5				SF-10KP004	1607355	100
	0.5 ... 1.0				SF-6AP2000	1605554	100
		Accessories			Accessories		
Crimping tools		Order separately, see page 159			Order separately, see page 159		

Notes:

Every connector housing type can be equipped with pin or socket contacts.

For reasons pertaining to safety, only socket contacts may be used in the live part of the connector.

Mechanical and electrical data

Mechanical data

Housing material:	Copper zinc alloy (CuZn), die-cast zinc (GD-Zn)
Housing surface:	Nickel-plated/thick layer passivated (can be coated)
Insulating body:	Polyamide (PA 66)
Contact material:	Copper zinc alloy (CuZn)
Contact surface:	Nickel-plated (Ni) with gold coating (Au)
Contact connection method:	Crimp version
Sealing and O-ring:	Fluorocarbon rubber (FKM)
Ambient temperature:	-40°C ... 130°C
Cable entry:	Cable and coupler connectors for an outer cable diameter of 7.5 - 18 mm, shielded
Type of locking:	M23 SPEEDCON screw locking
Mech. insertion/withdrawal cycles:	Default: 100
Protection class:	IP67 when locked

Electrical data

Number of positions		13 (4+4+4+PE), CAT5				13 (8+4+PE)							
Contacts		4	+	4	+	4	+	PE	8	+	4	+	PE
Contact Ø	[mm]	0.8		1.0		2.0		2.0	1.0		2.0		2.0
Litz wire cross sections													
Cable and coupler connectors:													
	Max. cable Ø of 18 mm	[mm ²]	0.08 ... 0.5	0.06 ... 1.0	0.25 ... 4.0	0.25 ... 4.0	0.06 ... 1.0	0.25 ... 4.0	0.25 ... 4.0				
Device connectors:		[mm ²]	0.08 ... 0.5	0.06 ... 1.0	0.25 ... 4.0	0.25 ... 4.0	0.06 ... 1.0	0.25 ... 4.0	0.25 ... 4.0				
Nominal current per contact at 25°C ¹⁾			3.6	8	30	-	8	30	-				
Specifications according to DIN EN 61984:2009													
Rated voltage	[V AC/DC]	50	50	630/850	-	50	630/850	-					
Test/surge voltage	[kV AC]	1.5	1.5	6	-	1.5	6	-					
Surge voltage category			III				III						
Pollution degree ²⁾			3				3						
Installation height		[m]	Up to 3000				Up to 3000						
Cable clamping area ³⁾		Max. Ø [mm]	18				18						

¹⁾ The effective current carrying capacity must be determined using a derating curve, if necessary, according to the application.

²⁾ The values specified assume that the connector pair is correctly locked and is only disconnected for testing and maintenance purposes. If the connector is unlocked and exposed to ambient conditions, and if there is a danger of pollution, the connector must be sealed using a protective cap ≥ IP54.

³⁾ The cable clamping areas specified on the following pages may vary depending on the cable material/structure. Selection and testing is the responsibility of the user.

Contact chamber numbering
(view of plug-in side)

Number of positions	Pin		Socket	
<p>13-pos., CAT5 (4 + 4 + 4 + PE) Crimp</p>				
<p>13-pos. (8 + 4 + PE) Crimp</p>				

Connectors

M23 - hybrid connectors

Selection guide

M23 hybrid connectors up to 30 A/630 V AC/850 V DC, crimp ranges up to 4 mm²

- Cable connectors
- Coupler connectors
- Device connectors (device flanges)

The connectors are supplied pre-assembled and are complemented by the respective crimp contacts.

The product chart provides an overview of the available components.

Connector type

Cable connectors

SPEEDCON fast locking system, see page 104.

M23 x 1 standard interlocking, see page 105.



Shielded

Coupler connectors

See page 106.

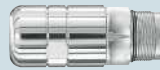

Shielded

Device connectors

Straight, see page 107.



Angled, rotatable, flange dimensions: 26 mm x 26 mm, see page 108.



Angled, rotatable, flange dimensions: 28 mm x 28 mm, see page 108.



Shielded

Crimp contacts

Socket contacts

Turned, see page 109.



Tools/accessories

Crimping pliers with digital display for turned crimp contacts, see page 159.



All housings can be fitted with pin or socket crimp contacts

Pin contacts

Turned, see page 109.



Accessories

Color rings for individually marking the connectors, see page 164.

**Note:**

For reasons of safety, only socket contacts may be used in the live part of the connector.

Connectors

M23 - hybrid connectors

M23 cable connector, hybrid, SPEEDCON fast locking system

- 4 x power + PE, 4 x signal, 4 x data
- 4 x power + PE, 8 x signal



Cable connector, socket assembly



Cable connector, pin assembly

Description	Cable clamping area	Ordering data				Ordering data			
		Order No.	Pcs. / Pkt.	Order No.	Pcs. / Pkt.	Order No.	Pcs. / Pkt.	Order No.	Pcs. / Pkt.
		4 x signal + CAT5		8 x signal		4 x signal + CAT5		8 x signal	
Cable connector , with contact carrier, without contacts, crimp connection									
Universal gasket	7.5 mm ... 18 mm	1621517	1	1621524	1	1621529	1	1621534	1
	7.5 mm ... 9 mm	1621520	1	1621525	1	1621530	1	1621535	1
	9 mm ... 12 mm	1621521	1	1621526	1	1621531	1	1621536	1
	12 mm ... 15 mm	1621522	1	1621527	1	1621532	1	1621537	1
	15 mm ... 18 mm	1621523	1	1621528	1	1621533	1	1621538	1
		Accessories				Accessories			
Crimp contacts		See page 109				See page 109			
Color rings, 50 pcs. in set (to be ordered separately)		See Catalog 2, page 367				See Catalog 2, page 367			

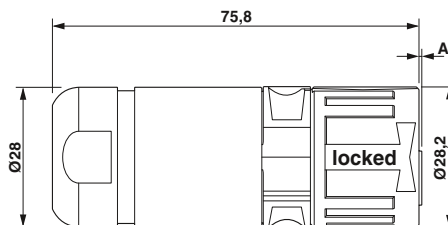

Pin version: dimension A = 0.2 mm, socket version: dimension A = 0 mm

M23 cable connector, hybrid, standard interlocking

- 4 x power + PE, 4 x signal, 4 x data
- 4 x power + PE, 8 x signal



Cable connector, socket assembly



Cable connector, pin assembly

		Ordering data				Ordering data			
Description	Cable clamping area	Order No.	Pcs. / Pkt.	Order No.	Pcs. / Pkt.	Order No.	Pcs. / Pkt.	Order No.	Pcs. / Pkt.
		4 x signal + CAT5		8 x signal		4 x signal + CAT5		8 x signal	
Cable connector, with contact carrier, without contacts, crimp connection									
Universal gasket	7.5 mm ... 18 mm	1621997	1	1622002	1	1622007	1	1622012	1
	7.5 mm ... 9 mm	1621998	1	1622003	1	1622008	1	1622013	1
	9 mm ... 12 mm	1621999	1	1622004	1	1622009	1	1622014	1
	12 mm ... 15 mm	1622000	1	1622005	1	1622010	1	1622015	1
	15 mm ... 18 mm	1622001	1	1622006	1	1622011	1	1622016	1
		Accessories				Accessories			
Crimp contacts		See page 109				See page 109			
Color rings, 50 pcs. in set (to be ordered separately)		See Catalog 2, page 367				See Catalog 2, page 367			

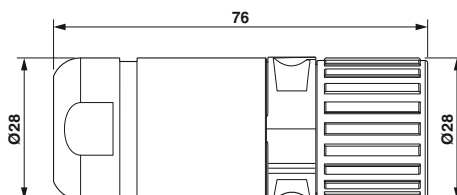

Connectors

M23 - hybrid connectors

M23 coupler connector, hybrid

- 4 x power + PE, 4 x signal, 4 x data
- 4 x power + PE, 8 x signal



Coupler connector,
socket assembly



Coupler connector,
pin assembly

Description	Cable clamping area	Ordering data				Ordering data			
		Order No.	Pcs. / Pkt.	Order No.	Pcs. / Pkt.	Order No.	Pcs. / Pkt.	Order No.	Pcs. / Pkt.
		4 x signal + CAT5		8 x signal		4 x signal + CAT5		8 x signal	
Coupler connector, with contact carrier, without contacts, crimp connection									
Universal gasket	7.5 mm ... 18 mm	1621539	1	1621544	1	1621549	1	1621554	1
	7.5 mm ... 9 mm	1621540	1	1621545	1	1621550	1	1621555	1
	9 mm ... 12 mm	1621541	1	1621546	1	1621551	1	1621556	1
	12 mm ... 15 mm	1621542	1	1621547	1	1621552	1	1621557	1
	15 mm ... 18 mm	1621543	1	1621548	1	1621553	1	1621558	1
		Accessories				Accessories			
Crimp contacts		See page 109				See page 109			
Color rings, 50 pcs. in set (to be ordered separately)		See Catalog 2, page 367				See Catalog 2, page 367			

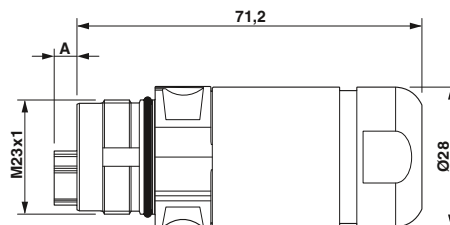

Pin version: dimension A = 4.7 mm, socket version:
dimension A = 0 mm

M23 device connector, hybrid, straight

- 4 x power + PE, 4 x signal, 4 x data
- 4 x power + PE, 8 x signal



Device connector, straight, socket assembly



Device connector, straight, pin assembly

Description	Ordering data				Ordering data				
	Order No.	Pcs. / Pkt.	Order No.	Pcs. / Pkt.	Order No.	Pcs. / Pkt.	Order No.	Pcs. / Pkt.	
Device connector, with contact carrier, without contacts	4 x signal + CAT5		8 x signal		4 x signal + CAT5		8 x signal		
Flange dimensions: 26 mm x 26 mm	1621567	1	1621568	1	1621569	1	1621570	1	
Accessories									
Crimp contacts	See page 109				See page 109				
Color rings, 50 pcs. in set (to be ordered separately)	See Catalog 2, page 367				See Catalog 2, page 367				

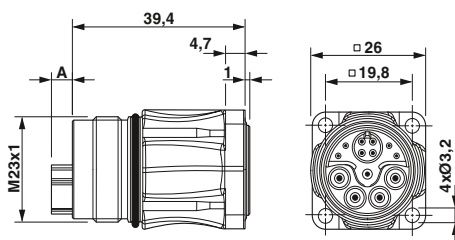

Pin version: dimension A = 4.75 mm, socket version: dimension A = 0 mm

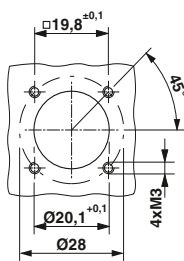

Installation dimensions

Connectors

M23 - hybrid connectors

M23 device connector, hybrid, angled, rotatable

- 4 x power + PE, 4 x signal, 4 x data
- 4 x power + PE, 8 x signal
- Housing can be freely rotated by 310°



Device connector, angled, rotatable, socket assembly



Device connector, angled, rotatable, pin assembly

Description	Ordering data				Ordering data			
	Order No.	Pcs. / Pkt.	Order No.	Pcs. / Pkt.	Order No.	Pcs. / Pkt.	Order No.	Pcs. / Pkt.
Device connector, with contact carrier, without contacts	4 x signal + CAT5		8 x signal		4 x signal + CAT5		8 x signal	
Flange dimensions: 26 mm x 26 mm	1621563	1	1621564	1	1621565	1	1621566	1
Device connector, with contact carrier, without contacts	4 x signal + CAT5		8 x signal		4 x signal + CAT5		8 x signal	
Flange dimensions: 28 mm x 28 mm	1621559	1	1621560	1	1621561	1	1621562	1
	Accessories				Accessories			
Crimp contacts	See page 109				See page 109			
Color rings, 50 pcs. in set (to be ordered separately)	See Catalog 2, page 367				See Catalog 2, page 367			

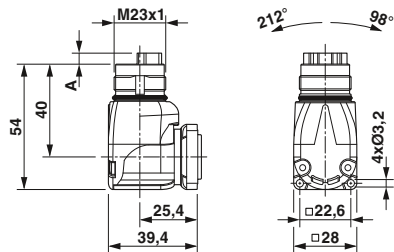

Pin version: dimension A = 4.7 mm, socket version: dimension A = 0 mm

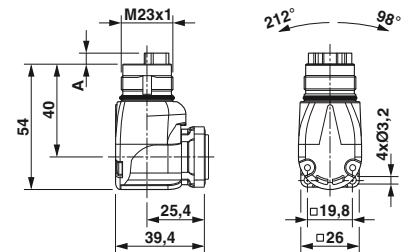

Pin version: dimension A = 4.7 mm, socket version: dimension A = 0 mm

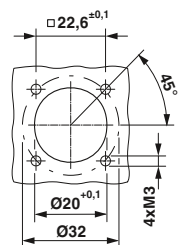

Installation dimensions

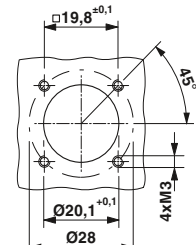

Installation dimensions

Crimp contacts



Crimp contacts, socket



Crimp contacts, pin

Description	Connection cross section [mm ²]	Ordering data			Ordering data		
		Type	Order No.	Pcs. / Pkt.	Type	Order No.	Pcs. / Pkt.
Contacts, Ø 0.8 mm	0.08 mm ² ... 0.25 mm ²	SF-08KS010	1621571	100	SF-08KP010	1621574	100
	0.34 mm ² ... 0.5 mm ²	SF-08KS020	1621573	100	SF-08KP020	1621575	100
Contacts, Ø 1.0 mm	0.06 mm ² ... 0.25 mm ²	ST-10KS010	1618239	100	ST-10KP010	1618255	100
	0.34 mm ² ... 0.5 mm ²	ST-10KS020	1618251	100	ST-10KP020	1618256	100
	0.5 mm ² ... 1.0 mm ²	ST-10KS030	1618254	100	ST-10KP030	1618261	100
Contacts, Ø 2.0 mm	0.25 mm ² ... 1.0 mm ²	SF-20KS021	1621576	50	SF-20KP021	1621579	50
	1.0 mm ² ... 2.5 mm ²	SF-20KS022	1621577	50	SF-20KP022	1621580	50
	2.5 mm ² ... 4.0 mm ²	SF-20KS023	1621578	50	SF-20KP023	1621581	50

Mechanical and electrical data

Mechanical data	
Housing material:	Copper zinc alloy (CuZn), die-cast zinc (GD-Zn)
Housing surface:	Nickel-plated/thick layer passivated (can be coated)
Insulating body:	Polyamide (PA 66)
Contact material:	Copper zinc alloy (CuZn)
Contact surface:	Nickel-plated (Ni) with gold coating (Au)
Contact connection method:	Crimp version
Sealing and O-ring:	Fluorocarbon rubber (FKM)
Ambient temperature:	-40°C ... 125°C
Cable entry:	Cable and coupler connectors for a cable outside diameter of 3.5 - 11 mm, shielded (M17 Compact) 5 - 12.5 mm, shielded (M17)
Type of locking:	M17 SPEEDCON fast locking system, cable connector With M17 x 1 coarse-pitch thread as an option
Mech. insertion/withdrawal cycles:	Standard: 100, punched-rolled C-HC crimp contacts: up to 500
Protection class:	IP67 when locked

Electrical data		4 (3+PE)	6 (5+PE)	7 (6+PE)	8 (7+PE)	9 (5+3+PE)				
Number of positions		3 + PE	5 + PE	6 + PE	7 + PE	5	+	3	+	PE
Contacts		2	1	1	1	0.6		1		1
Contact Ø	[mm]									
Litz wire cross section, crimp contacts	[mm ²]	0.25 ... 2.5	0.06 ... 1.0	0.06 ... 1.0	0.06 ... 1.0	0.06 ... 0.5		0.06 ... 1.0		0.06 ... 1.0
Turned										
Litz wire cross section, C-HC crimp contacts	[mm ²]	–	0.08 ... 0.56	0.06 ... 0.56	0.06 ... 0.56	–		–		–
Punched-rolled										
Nominal current per contact at 25°C ¹⁾		20 (25) ²⁾	14	14	14	3.6		14		–
Specifications according to DIN EN 61984:2009										
Rated voltage	[V AC/DC]	630	630	630	630	60		630		–
Test/surge voltage	[kV AC]	6	6	6	6	1.5		6		–
Surge voltage category		III	III	III	III			III		
Pollution degree ³⁾		3	3	3	3			3		
Installation height	[m]	Up to 3000	Up to 3000	Up to 3000	Up to 3000			Up to 3000		
Cable clamping area ⁴⁾	Max. Ø [mm]	12.5	12.5	12.5	12.5			12.5		







¹⁾ The effective current carrying capacity must be determined using a derating curve, if necessary, according to the application.

²⁾ 25 A in the case of assignment with 3 x 2.5 mm²

³⁾ The values specified assume that the connector pair is correctly locked and is only disconnected for testing and maintenance purposes. If the connector is unlocked and exposed to ambient conditions, and if there is a danger of pollution, the connector must be sealed using a protective cap ≥ IP54.

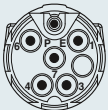
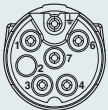
⁴⁾ The cable clamping areas specified on the following pages may vary depending on the cable material/structure. Selection and testing is the responsibility of the user.

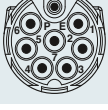
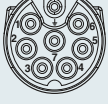
Contact chamber numbering
(view of plug-in side)

Number of positions	Pin	Socket
4-pos. (3+PE) Crimp		
6-pos. (5+PE) (contact chambers 2+5 closed) Crimp		
7-pos. (6+PE) Crimp		
8-pos. (7+PE) Crimp		
9-pos. (5+3+PE) Crimp		

* with grounding spring
PE leading

* with grounding spring
PE leading

Note:

The connectors can be fitted with pin or socket contacts according to the application.

For safety reasons, only socket contacts may be used in the live part of the connector.

Connectors

M17 - power connectors

Selection guide

M17 power connectors, 4/6/7/8/9-pos., up to 20 A/630 V, crimp ranges: 0.06 mm² to 2.5 mm²

- Cable connectors
- Coupler connectors
- Device connectors (device flanges)

The connectors are supplied fully assembled and are complemented by the respective crimp contacts.

Each housing type can be fitted with pin or socket contacts.

Cable connectors can be equipped with SPEEDCON fast locking system or with M17 x 1 coarse-pitch thread as an option. The connectors with external thread are fully compatible with standard threads and the SPEEDCON fast locking system.

The product chart provides an overview of the available components.

Connector type

Cable connectors

SPEEDCON fast locking system, M17 Compact, see page 114.



M17, see page 118.



M17 x 1 standard interlocking, M17, see page 119.

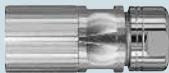

Square mounting flange for cable and coupler connectors for wall mounting, see page 162.



Shielded

Coupler connectors/panel feed-through

Coupler connector M17 Compact, see page 115.



M17, see page 120.



Panel feed-through M17 Compact, see page 116.



Shielded

Device connectors

Straight, M17 Compact, see page 117.



Straight, M17, see page 121.



Straight, with central fastening thread, front mounting, M17, see page 123.

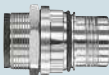

Straight, with central fastening thread, rear mounting, M17, see page 123.



Shielded

Angled, rotatable, M17, see page 122.



Crimp contacts

Socket contacts

Turned, see page 125.



Punched-rolled, taped,
see page 124.



All housings can be fitted with pin or socket crimp contacts

Pin contacts

Turned, see page 125.



Punched-rolled, taped,
see page 124.



Tools/accessories

Crimping tools

Crimping pliers for punched-rolled
C-HC crimp contacts,
see page 158.



Crimping pliers with digital display for turned
crimp contacts,
see page 159.



Tools/accessories

Unlocking tool for device connectors with contact
carriers for snapping in from the device side,
see page 162.



Color rings for individually marking the connectors,
see page 164.

**Note:**

For reasons of safety, only socket contacts
may be used in the live part of the connector.

Connectors

M17 - power connectors

M17 Compact cable connector

- High packing density in a compact product
- Individual marking of connectors with color rings



3+PE, 5+PE, 6+PE-pos.



7+PE, 5+3+PE-pos.

Description		Cable clamping area		Ordering data									
				Order No.	Pcs. / Pkt.	Order No.	Pcs. / Pkt.	Order No.	Pcs. / Pkt.	Order No.	Pcs. / Pkt.	Order No.	Pcs. / Pkt.
Cable connector, with contact carrier, without contacts, for socket assembly		3.5 mm ... 5.5 mm		1618312	1	1618621	1	1618632	1	1618633	1	1618674	1
		5 mm ... 9.2 mm		1618408	1	1618620	1	1618631	1	1618634	1	1618675	1
		9 mm ... 11.2 mm		1618603	1	1618619	1	1618630	1	1618635	1	1618676	1
Cable connector, with contact carrier, without contacts, for pin assembly		3.5 mm ... 5.5 mm		1618602	1	1618614	1	1618622	1	1618640	1	1618681	1
		5 mm ... 9.2 mm		1618574	1	1618615	1	1618623	1	1618639	1	1618680	1
		9 mm ... 11.2 mm		1618575	1	1618616	1	1618624	1	1618638	1	1618679	1
				Accessories									
Crimp contacts				Order separately, see page 124 onwards									
Color rings, 50 pcs. in set (to be ordered separately)				See page 164									

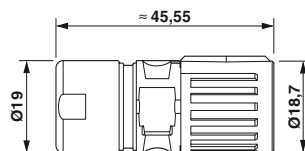

M17 Compact coupler connector

- Compatible with mating plugs with SPEEDCON or M17 standard knurled nuts
- Individual marking of connectors with color rings



3+PE, 5+PE, 6+PE-pos.



7+PE, 5+3+PE-pos.

Description	Cable clamping area	Ordering data					
		Order No.	Pcs. / Pkt.	Order No.	Pcs. / Pkt.	Order No.	Pcs. / Pkt.
Coupler connector , with contact carrier, without contacts, for socket assembly	3.5 mm ... 5.5 mm	1618695	1	1618696	1	1618708	1
	5 mm ... 9.2 mm	1618694	1	1618697	1	1618709	1
	9 mm ... 11.2 mm	1618693	1	1618698	1	1618710	1
Coupler connector , with contact carrier, without contacts, for pin assembly	3.5 mm ... 5.5 mm	1620614	1	1618703	1	1618704	1
	5 mm ... 9.2 mm	1618406	1	1618702	1	1618705	1
	9 mm ... 11.2 mm	1618690	1	1618701	1	1618706	1
		Ordering data					
		Order No.	Pcs. / Pkt.	Order No.	Pcs. / Pkt.	Order No.	Pcs. / Pkt.
		7+PE-pos.		5+3+PE-pos.			
		1618716	1	1618748	1		
		1618717	1	1618749	1		
		1618718	1	1618750	1		
		Accessories					
Crimp contacts		Order separately, see page 124 onwards					
Color rings, 50 pcs. in set (to be ordered separately)		See page 164					

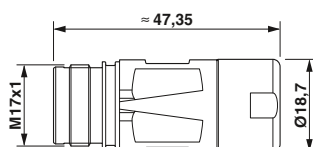

Connectors

M17 - power connectors

M17 Compact panel feed-through

- Panel feed-throughs suitable for front and rear mounting
- Compatible with mating plugs with SPEEDCON or M17 standard knurled nuts
- Individual marking of connectors with color rings
- **Flange dimensions:**
25.7 mm x 25.7 mm



3+PE, 5+PE, 6+PE-pos.



7+PE, 5+3+PE-pos.

Description	Cable clamping area	Ordering data			Ordering data		
		Order No.	Pcs. / Pkt.	Order No.	Pcs. / Pkt.	Order No.	Pcs. / Pkt.
Panel feed-through, with contact carrier, without contacts, for socket assembly	3.5 mm ... 5.5 mm	1618762	1	1618772	1	1618780	1
	5 mm ... 9 mm	1618763	1	1618773	1	1618781	1
	9 mm ... 11 mm	1618764	1	1618774	1	1618782	1
Panel feed-through, with contact carrier, without contacts, for pin assembly	3.5 mm ... 5.5 mm	1618402	1	1618767	1	1618776	1
	5 mm ... 9 mm	1618407	1	1618768	1	1618777	1
	9 mm ... 11 mm	1618760	1	1618769	1	1618778	1
		Accessories			Accessories		
Crimp contacts		Order separately, see page 124 onwards			Order separately, see page 124 onwards		
Color rings, 50 pcs. in set (to be ordered separately)		See page 164			See page 164		

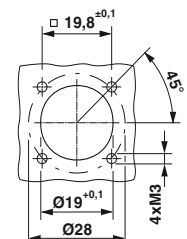
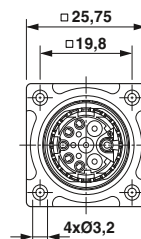
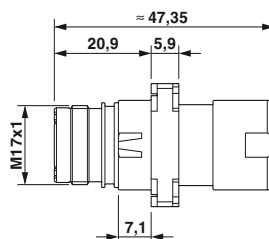

Installation dimensions

M17 Compact device connector, front mounting

- Compatible with mating plugs with SPEEDCON or M17 standard knurled nuts
- Individual marking of connectors with color rings
- **Flange dimensions: 21.6 mm x 21.6 mm**



3+PE, 5+PE, 6+PE-pos.

7+PE, 5+3+PE-pos.

Description	Ordering data			Ordering data		
	Order No.	Pcs. / Pkt.	Order No.	Pcs. / Pkt.	Order No.	Pcs. / Pkt.
Device connector, with contact carrier, without contacts, for socket assembly						
Contact insert for support on the device						
Device connector, with contact carrier, without contacts, for pin assembly						
Contact insert for support on the device						
Device connector, with contact carrier, without contacts, for socket assembly						
Contact insert can be snapped in						
Device connector, with contact carrier, without contacts, for pin assembly						
Contact insert can be snapped in						
	Accessories			Accessories		
Crimp contacts	Order separately, see page 124 onwards			Order separately, see page 124 onwards		
Color rings, 50 pcs. in set (to be ordered separately)	See page 164			See page 164		

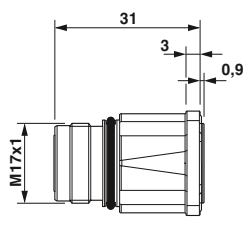

Flange dimensions 21.6 mm x 21.6 mm

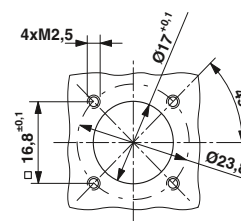

Installation dimensions

Cable connector, M17 standard interlocking

- Standard knurled nuts compatible with mating plugs with SPEEDCON or M17 standard external thread
- Individual marking of connectors with color rings



3+PE, 5+PE, 6+PE-pos.



7+PE, 5+3+PE-pos.

Description	Cable clamping area	Ordering data					
		Order No.	Pcs. / Pkt.	Order No.	Pcs. / Pkt.	Order No.	Pcs. / Pkt.
Cable connector, with contact carrier, without contacts, for socket assembly	5 mm ... 8 mm	1607682	1	1607717	1	1613577	1
	8 mm ... 10 mm	1607684	1	1607719	1	1613579	1
	10 mm ... 12.5 mm	1624537	1	1624534	1	1624549	1
Cable connector, with contact carrier, without contacts, for pin assembly	5 mm ... 8 mm	1607663	1	1607699	1	1613558	1
	8 mm ... 10 mm	1607666	1	1607701	1	1613560	1
	10 mm ... 12.5 mm	1624534	1	1624540	1	1624546	1

Ordering data					
Order No.	Pcs. / Pkt.	Order No.	Pcs. / Pkt.	Order No.	Pcs. / Pkt.
1607755	1	1613619	1		
1607758	1	1613621	1		
1624555	1	1624638	1		

Accessories					
Crimp contacts	Order separately, see page 124 onwards				
Color rings, 50 pcs. in set (to be ordered separately)	See page 164				

Accessories					
Crimp contacts	Order separately, see page 124 onwards				
Color rings, 50 pcs. in set (to be ordered separately)	See page 164				

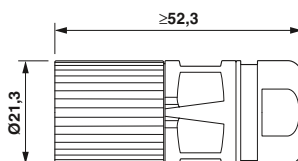

Connectors

M17 - power connectors

Coupling connector

- Compatible with mating plugs with SPEEDCON or M17 standard knurled nuts
- Individual marking of connectors with color rings



3+PE, 5+PE, 6+PE-pos.



7+PE, 5+3+PE-pos.

Description	Cable clamping area	Ordering data					
		Order No.	Pcs. / Pkt.	Order No.	Pcs. / Pkt.	Order No.	Pcs. / Pkt.
Coupler connector , with contact carrier, without contacts, for socket assembly	5 mm ... 8 mm	1607688	1	1607723	1	1613583	1
	8 mm ... 10 mm	1607689	1	1607724	1	1613584	1
	10 mm ... 12.5 mm	1624539	1	1624545	1	1624551	1
Coupler connector , with contact carrier, without contacts, for pin assembly	5 mm ... 8 mm	1607670	1	1607706	1	1613564	1
	8 mm ... 10 mm	1607671	1	1607707	1	1613565	1
	10 mm ... 12.5 mm	1624536	1	1624542	1	1624548	1
		Accessories					
Crimp contacts		Order separately, see page 124 onwards					
Color rings, 50 pcs. in set (to be ordered separately)		See page 164					

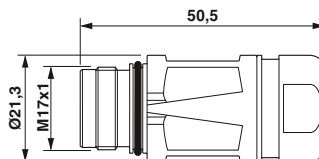

Device connector, straight, front mounting

- Compatible with mating plugs with SPEEDCON or M17 standard knurled nuts
- Contact insert for support on the device or can be snapped in
- Individual marking of connectors with color rings
- **Flange dimensions: 25.7 mm x 25.7 mm**



3+PE, 5+PE, 6+PE-pos.



7+PE, 5+3+PE-pos.

Ordering data					
Order No.	Pcs. / Pkt.	Order No.	Pcs. / Pkt.	Order No.	Pcs. / Pkt.

Ordering data					
Order No.	Pcs. / Pkt.	Order No.	Pcs. / Pkt.	Order No.	Pcs. / Pkt.

Description
Device connector , with contact carrier, without contacts, for socket assembly Contact insert for support on the device
Device connector , with contact carrier, without contacts, for pin assembly Contact insert for support on the device
Device connector , with contact carrier, without contacts, for socket assembly Contact insert can be snapped in
Device connector , with contact carrier, without contacts, for pin assembly Contact insert can be snapped in

3+PE-pos.	1619189	1	1619191	1	1619193	1
5+PE-pos.	1619186	1	1619190	1	1619192	1
6+PE-pos.	1619212	1	1619214	1	1619216	1
	1619209	1	1619213	1	1619215	1

7+PE-pos.	1619195	1	1620459	1		
5+3+PE-pos.	1619194	1	1620460	1		
	1619218	1	1620461	1		
	1619217	1	1620462	1		

Accessories
Order separately, see page 124 onwards See page 164

Accessories
Order separately, see page 124 onwards See page 164

Crimp contacts Color rings, 50 pcs. in set (to be ordered separately)

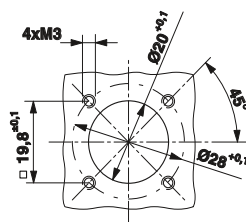

Installation dimensions

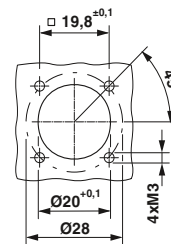

Installation dimensions

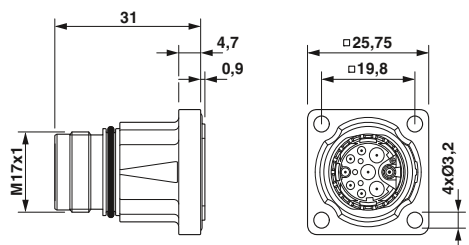

Contact insert for support on the device

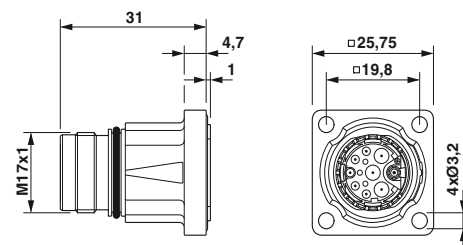

Contact insert can be snapped in

Connectors

M17 - power connectors

Device connector, angled, rotatable, front mounting

- Compatible with mating plugs with SPEEDCON or M17 standard knurled nuts
- Housing can be freely rotated up to 308°
- Individual marking of connectors with color rings
- Flange versions for M2.5/M3 attachment
- **Flange dimensions:**
25.7 mm x 25.7 mm



3+PE, 5+PE, 6+PE-pos.



7+PE, 5+3+PE-pos.

Description	Ordering data			Ordering data		
	Order No.	Pcs. / Pkt.	Order No.	Pcs. / Pkt.	Order No.	Pcs. / Pkt.
Device connector, angled, rotatable, with contact carrier, without contacts, for socket contacts						
Fixing with M2.5	1620428	1	1620432	1	1620434	1
Device connector, angled, rotatable, with contact carrier, without contacts, for pin contacts						
Fixing with M2.5	1620427	1	1620431	1	1620433	1
Device connector, angled, rotatable, with contact carrier, without contacts, for socket contacts						
Fixing with M3	1620443	1	1620447	1	1620449	1
Device connector, angled, rotatable, with contact carrier, without contacts, for pin contacts						
Fixing with M3	1620444	1	1620448	1	1620450	1
	Accessories			Accessories		
Crimp contacts	Order separately, see page 124 onwards			Order separately, see page 124 onwards		
Color rings, 50 pcs. in set (to be ordered separately)	See page 164			See page 164		

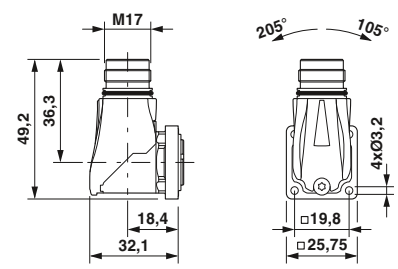
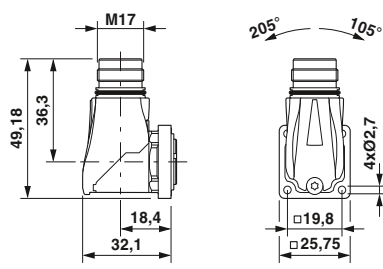
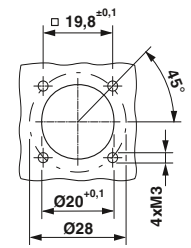
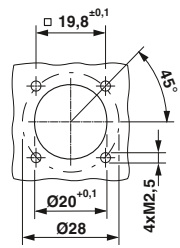

**Device connector,
central fastening thread,
front/rear mounting**

- Compatible with mating plugs with SPEEDCON or M17 standard knurled nuts
- Snapping in the contact carriers from the device side
- Individual marking of connectors with color rings



3+PE, 5+PE, 6+PE-pos.



7+PE, 5+3+PE-pos.

Ordering data					
Order No.	Pcs. / Pkt.	Order No.	Pcs. / Pkt.	Order No.	Pcs. / Pkt.

1613546	1	1613550	1	1613572	1
1613544	1	1613548	1	1613553	1

1613547	1	1613551	1	1613587	1
1613545	1	1613549	1	1613568	1

Ordering data					
Order No.	Pcs. / Pkt.	Order No.	Pcs. / Pkt.	Order No.	Pcs. / Pkt.

1613592	1	1613614	1		
1613590	1	1613595	1		

1613593	1	1613629	1		
1613591	1	1613610	1		

Accessories			
Type	Order No.	Pcs. / Pkt.	
ST-E2015151	1613831	10	
RC-13041	1600417	10	

Order separately, see page 124 onwards
See page 164

Accessories			
Type	Order No.	Pcs. / Pkt.	
ST-E2015151	1613831	10	
RC-13041	1600417	10	

Order separately, see page 124 onwards
See page 164

Description
Device connector, front mounting , M18 x 0.75 fastening thread, with contact carrier, without contacts, for socket assembly
Device connector, front mounting , M18 x 0.75 fastening thread, with contact carrier, without contacts, for pin contacts
Device connector, rear mounting , M20 x 1.5 fastening thread, with contact carrier, without contacts, for socket contacts
Device connector, rear mounting , M20 x 1.5 fastening thread, with contact carrier, without contacts, for pin contacts

Description
Locking nut , for mounting bore holes and polarization
M18 x 0.75
M20 x 1.5
Crimp contacts
Color rings , 50 pcs. in set (to be ordered separately)

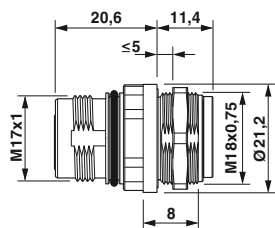

Front mounting, M18 x 0.75, order locking nut separately

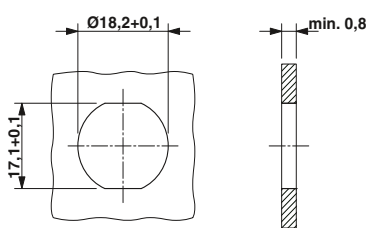

Installation dimensions: mounting with anti-rotation protection and locking nut

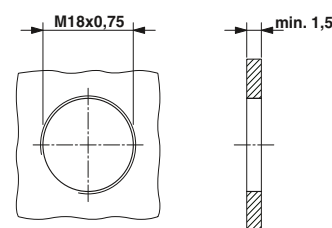

Installation dimensions: mounting with thread

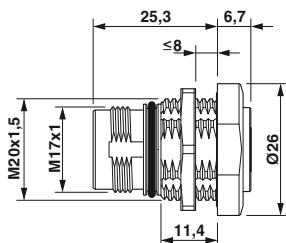

Rear mounting, M20 x 1.5, order locking nut separately

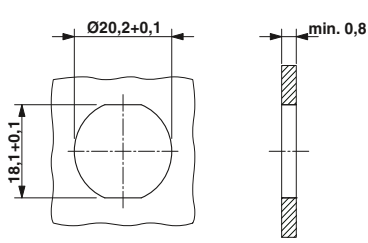

Installation dimensions: mounting with anti-rotation protection and locking nut

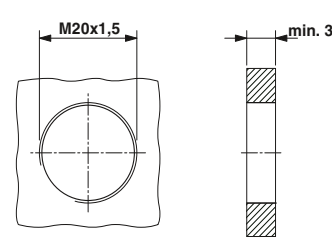

Installation dimensions: mounting with thread

Connectors

M17 - power connectors

Crimp contacts, punched-rolled

C-HC® are punched-rolled contacts. They are designed for high insertion/withdrawal cycles.

The contacts are available taped on rolls for manual or automatic processing.

Note: depending on the litz wire used, the connection cross sections (crimp ranges) may deviate from the listed values. For reasons of safety, only socket contacts may be used in the live part of the connector.



C-HC socket contacts



C-HC pin contacts

Description	Connection cross section [mm ²]
Crimp contacts, C-HC punched-rolled, Ø 1.0 mm, 2500 pcs./roll	
	0.06 mm ² ... 0.25 mm ²
	0.2 mm ² ... 0.56 mm ²
Crimp contact C-HC punched-rolled, Ø 1.0 mm, 10,000 pcs./roll	
	0.06 mm ² ... 0.25 mm ²
	0.2 mm ² ... 0.56 mm ²

Crimping tools

Ordering data		
Type	Order No.	Pcs. / Pkt.
SF-10KS320	1607031	1
SF-10KS350	1607032	1
SF-10KS330	1607358	1
SF-10KS360	1607361	1

Accessories
Order separately, see page 158 onwards

Ordering data		
Type	Order No.	Pcs. / Pkt.
SF-10KP320	1615961	1
SF-10KP350	1615963	1
SF-10KP330	1615962	1
SF-10KP360	1615964	1

Accessories
Order separately, see page 158 onwards

Contact diameter

Number of positions	Number of contacts	Contact Ø [mm]
4(3+PE)	4	2
6(5+PE)	6	1
7(6+PE)	7	1
8(7+PE)	8	1
9(5+3+PE)	5+3+PE	0.6+1+1
17	17	0.6

Crimp contacts, turned

M17 power connectors are fitted with contacts with \varnothing 2 mm, \varnothing 1 mm or \varnothing 0.6 mm depending on the number of positions (see table below).

Note: depending on the litz wire used, the connection cross sections (crimp ranges) may deviate from the listed values. For reasons of safety, only socket contacts may be used in the live part of the connector.



Crimp contacts socket



Crimp contacts pin

		Ordering data			Ordering data		
Description	Connection cross section [mm ²]	Type	Order No.	Pcs. / Pkt.	Type	Order No.	Pcs. / Pkt.
Contact socket \varnothing 2.0 mm	0.25 ... 1.0	ST-20KS010	1607657	50			
	1.0 ... 2.5	ST-20KS020	1607658	50			
Contacts, \varnothing 1.0 mm	0.06 mm ² ... 0.25 mm ²	ST-10KS010	1618239	100			
	0.34 mm ² ... 0.5 mm ²	ST-10KS020	1618251	100			
	0.5 mm ² ... 1.0 mm ²	ST-10KS030	1618254	100			
Contact socket \varnothing 0.6 mm	0.06 mm ² ... 0.25 mm ²	ST-06KS010	1607580	100			
	0.14 mm ² ... 0.34 mm ²	ST-06KS020	1607581	100			
	0.34 mm ² ... 0.50 mm ²	ST-06KS030	1607582	100			
Contact pin \varnothing 2.0 mm	0.25 ... 1.0				ST-20KP010	1607655	50
	1.0 ... 2.5				ST-20KP020	1607656	50
Contacts, \varnothing 1.0 mm	0.06 mm ² ... 0.25 mm ²				ST-10KP010	1618255	100
	0.34 mm ² ... 0.5 mm ²				ST-10KP020	1618256	100
	0.5 mm ² ... 1.0 mm ²				ST-10KP030	1618261	100
Contact pin \varnothing 0.6 mm	0.06 mm ² ... 0.25 mm ²				ST-06KP010	1607577	100
	0.14 mm ² ... 0.34 mm ²				ST-06KP020	1607578	100
	0.34 mm ² ... 0.50 mm ²				ST-06KP030	1607579	100
		Accessories			Accessories		
Crimping tools		Order separately, see page 159			Order separately, see page 159		

Contact diameter

Number of positions	Number of contacts	Contact \varnothing [mm]
4(3+PE)	4	2
6(5+PE)	6	1
7(6+PE)	7	1
8(7+PE)	8	1
9(5+3+PE)	5+3+PE	0.6+1+1
17	17	0.6

Mechanical and electrical data

Mechanical data

Housing material:	Copper zinc alloy (CuZn), die-cast zinc (GD-Zn)
Housing surface:	Nickel-plated/thick layer passivated (can be coated)
Insulating body:	Polyamide (PA 66)
Contact material:	Copper zinc alloy (CuZn)
Contact surface:	Nickel-plated (Ni) with gold coating (Au)
Contact connection method:	Crimp version
Sealing and O-ring:	Fluorocarbon rubber (FKM)
Ambient temperature:	-40°C ... 125°C
Cable entry:	Cable and coupler connectors for cable outside diameter of 7.5 - 18 mm, shielded
Type of locking:	M23 SPEEDCON screw locking, cable connector M23 x 1 coarse-pitch thread as an option
Mech. insertion/withdrawal cycles:	Standard: 100
Protection class:	IP67 in the locked state

Electrical data

Number of positions	6 (5+PE)		8 (4+3+PE)				
	Contacts	5 + PE	4	+	3	+	PE
Contact Ø	[mm]	2	1		2		2
Litz wire cross sections							
Short version, cable Ø max. 14 mm	[mm ²]	0.25 ... 2.5	0.06 ... 1.0		0.25 ... 2.5		0.25 ... 2.5
Long version, cable Ø max. 18 mm	[mm ²]	0.25 ... 4.0	0.06 ... 1.0		0.25 ... 4.0		0.25 ... 4.0
Device connectors	[mm ²]	0.25 ... 4.0	0.06 ... 1.0		0.25 ... 4.0		0.25 ... 4.0
Nominal current per contact at 25°C ¹⁾		30	9		30		-
Specifications according to DIN EN 61984:2009							
Rated voltage	[V AC/DC]	630 ²⁾	250		630 ²⁾		-
Test/surge voltage	[kV AC]	6	4		6		-
Surge voltage category		III			III		
Pollution degree ³⁾		3			3		
Installation height	[m]	Up to 3000			Up to 3000		
Cable clamping area ⁴⁾	Max. Ø [mm]	18			18		

¹⁾ The effective current carrying capacity must be determined using a derating curve, if necessary, according to the application.

²⁾ 400 V when fitted with punched-rolled C-HC contacts

³⁾ The values specified assume that the connector pair is correctly locked and is only disconnected for testing and maintenance purposes. If the connector is unlocked and exposed to ambient conditions, and if there is a danger of pollution, the connector must be sealed using a protective cap ≥ IP54.

⁴⁾ The cable clamping areas specified on the following pages may vary depending on the cable material/structure. Selection and testing is the responsibility of the user.

Contact chamber numbering (view of plug-in side)				
Number of positions	Pin		Socket	
6-pos. (5 + PE) Crimp		* with grounding spring, pos. 3 leading		* with grounding spring, pos. 3
8-pos. (4 + 3 + PE) Crimp		* with grounding spring, pos. 2		* with grounding spring, pos. 2 leading

Connectors

M23 - power connectors

Selection guide

M23 power connectors up to 30 A/630 V, crimp ranges up to 4 mm²

- Cable connectors
- Coupler connectors
- Device connectors (device flanges)
- Feed-throughs/panel feed-throughs

The connectors are supplied fully assembled and are complemented by the respective crimp contacts.

The product chart provides an overview of the available components.

Connector type

Cable connectors

Short, SPEEDCON fast locking system, see page 130.

M23 x 1 standard interlocking, see page 130.



Long, SPEEDCON fast locking system, see page 130.

M23 x 1 standard interlocking, see page 130.



Shielded

Device connectors with knurled nut

Straight, see page 133.



Angled, see page 133.

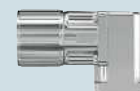

Coupler connectors

Short, see page 131.



Long, see page 131.

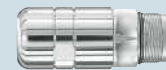

Shielded

With mounting flange
Short, see page 134.



With mounting flange
Long, see page 134.

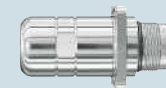

Device connectors

Straight, see page 132.



Angled, rotatable, flange dimensions: 26 mm x 26 mm, see page 132.



Angled, rotatable, flange dimensions: 28 mm x 28 mm see page 132.



Shielded

Panel feed-through

External socket - internal pin, see page 135.



Panel feed-throughs are supplied fully wired

Crimp contacts

Tools/accessories

Socket contacts

Socket contacts

Turned, see page 136.



Crimping pliers with digital display for turned crimp contacts, see page 159.



Pin contacts

Pin contacts

Turned, see page 136.



Accessories

Color rings for individually marking the connectors, see page 164.



Pin contacts

Note:

For reasons of safety, only socket contacts may be used in the live part of the connector.

Connectors

M23 - power connectors

Cable connector, long and short design

- SPEEDCON fast locking system or M23 standard interlocking
- Standard knurled nuts compatible with mating plugs with SPEEDCON or M23 standard external thread
- Individual marking of connectors with color rings



Cable connector, SPEEDCON



Cable connector, M23 standard interlocking

Description	Cable clamping area	Ordering data				Ordering data			
		Order No.	Pcs. / Pkt.	Order No.	Pcs. / Pkt.	Order No.	Pcs. / Pkt.	Order No.	Pcs. / Pkt.
		5+PE-pos.		4+3+PE-pos.		5+PE-pos.		4+3+PE-pos.	
Cable connector, short, with contact carrier, without contacts, for cable Ø 7.5 mm to 14 mm, connection cross section up to 2.5 mm²									
Universal gasket	7.5 mm ... 14 mm	1618197	1	1618207	1	1605532	1	1605602	1
	7.5 mm ... 9 mm	1618194	1	1618204	1	1605524	1	1605595	1
	9 mm ... 11 mm	1618195	1	1618205	1	1605526	1	1605596	1
	11 mm ... 14 mm	1618196	1	1618206	1	1605529	1	1605597	1
Cable connector, long, with contact carrier, without contacts, for cable Ø 7.5 mm to 18 mm, connection cross section up to 4 mm²									
Universal gasket	7.5 mm ... 18 mm	1618202	1	1618212	1	1605549	1	1605617	1
	7.5 mm ... 9 mm	1618201	1	1618211	1	1605548	1	1605614	1
	9 mm ... 12 mm	1618200	1	1618210	1	1605546	1	1605610	1
	12 mm ... 15 mm	1618199	1	1618209	1	1605545	1	1605607	1
	15 mm ... 18 mm	1618198	1	1618208	1	1605543	1	1605605	1
		Accessories				Accessories			
Crimp contacts		For socket contacts, see page 136				For socket contacts, see page 136			
Color rings, 50 pcs. in set (to be ordered separately)		See page 164				See page 164			

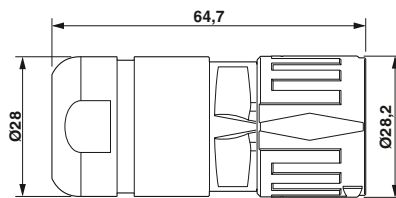

Short design

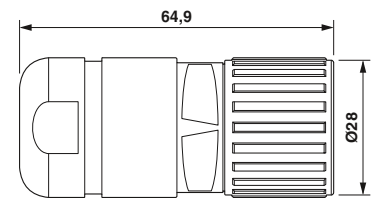

Short design

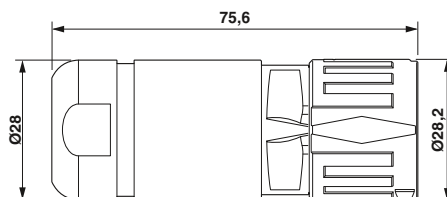

Long design

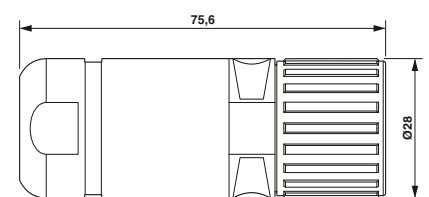

Long design

Coupler connector, long and short design

- Compatible with mating plugs with SPEEDCON or M23 standard knurled nuts
- Individual marking of connectors with color rings



Coupler connector, short



Coupler connector, long

Ordering data			
Order No.	Pcs. / Pkt.	Order No.	Pcs. / Pkt.
5+PE-pos.		4+3+PE-pos.	

Ordering data			
Order No.	Pcs. / Pkt.	Order No.	Pcs. / Pkt.
5+PE-pos.		4+3+PE-pos.	

Description	Cable clamping area
Coupler connector, short, with contact carrier, without contacts, for cable Ø 7.5 mm to 14 mm, connection cross section up to 2.5 mm²	
Universal gasket	7.5 mm ... 14 mm
	7.5 mm ... 9 mm
	9 mm ... 11 mm
	11 mm ... 14 mm
Coupler connector, long, with contact carrier, without contacts, for cable Ø 7.5 mm to 18 mm, connection cross section up to 4 mm²	
Universal gasket	7.5 mm ... 18 mm
	7.5 mm ... 9 mm
	9 mm ... 12 mm
	12 mm ... 15 mm
	15 mm ... 18 mm

1605499	1	1605575	1
1605494	1	1605568	1
1605496	1	1605570	1
1605498	1	1605571	1

1605510	1	1605583	1
1605509	1	1605582	1
1605508	1	1605581	1
1605507	1	1605580	1
1605505	1	1605578	1

Accessories
For pin contacts, see page 136 See page 164

Accessories
For pin contacts, see page 136 See page 164

Crimp contacts
Color rings, 50 pcs. in set (to be ordered separately)

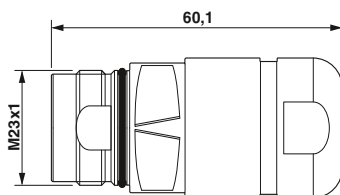

Short design

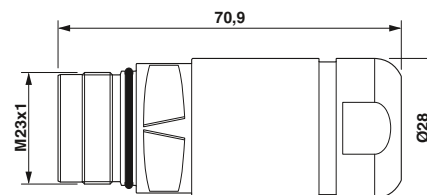

Long design

Connectors

M23 - power connectors

Device connector, straight and angled, rotatable

- Compatible with mating plugs with SPEEDCON or M23 standard knurled nuts



Device connector, straight



Device connector, angled rotatable

Ordering data

Description	Order No.	Pcs. / Pkt.	Order No.	Pcs. / Pkt.
Device connector with contact carrier without contacts				
Flange dimensions: 26 mm x 26 mm	1605520	1	1605589	1
Device connector , with reinforced contact carrier (black) for angled mating plugs, without contacts				
Flange dimensions: 26 mm x 26 mm	1620619	1	1620620	1
Device connector with contact carrier without contacts				
Flange dimensions: 28 mm x 28 mm				

Ordering data

Description	Order No.	Pcs. / Pkt.	Order No.	Pcs. / Pkt.
Device connector with contact carrier without contacts				
Flange dimensions: 28 mm x 28 mm	1620657	1	1620660	1
Device connector with contact carrier without contacts				
Flange dimensions: 28 mm x 28 mm	1620661	1	1620662	1

Accessories

Crimp contacts
Color rings, 50 pcs. in set (to be ordered separately)

For pin contacts, see page 136
See page 164

For pin contacts, see page 136
See page 164

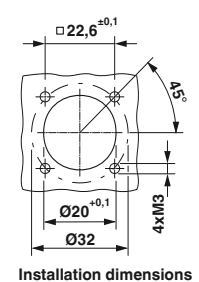
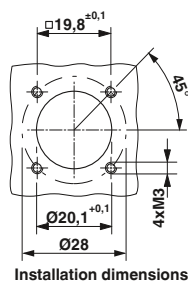
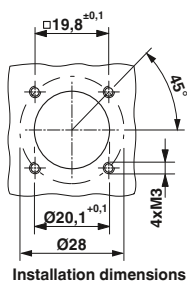
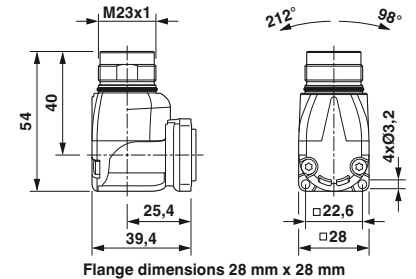
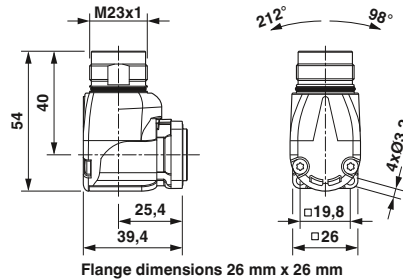
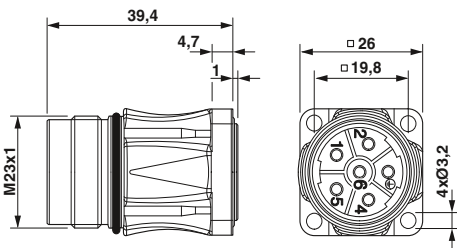

Device connector with knurled nut

Device connectors with knurled nuts must be equipped with socket contacts.
 – Standard knurled nuts compatible with mating plugs with SPEEDCON or M23 standard external thread



Device connector with knurled nut, straight



Device connector with knurled nut, angled fixed

Ordering data			
Order No.	Pcs. / Pkt.	Order No.	Pcs. / Pkt.

Accessories	
For socket contacts, see page 136	

Ordering data			
Order No.	Pcs. / Pkt.	Order No.	Pcs. / Pkt.

Accessories	
For socket contacts, see page 136	

Description
Device connector with knurled nut, straight , with contact carrier, without contacts
Device connector with knurled nut, angled, fixed , with contact carrier, without contacts
Crimp contacts

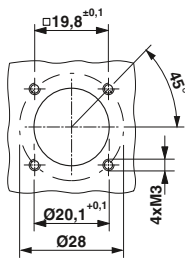
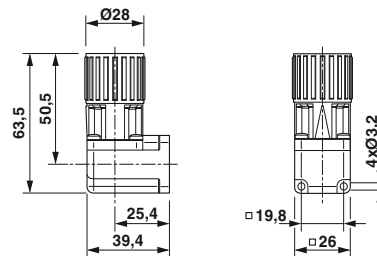
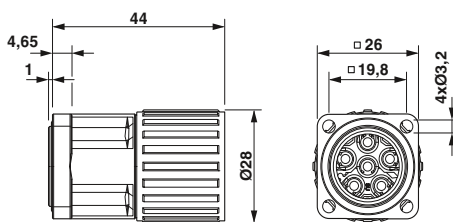

Installation dimensions

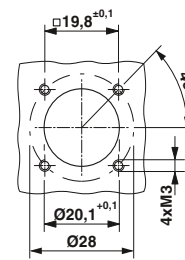

Installation dimensions

Connectors

M23 - power connectors

Panel feed-through, long and short design

- Rear mounting
- Compatible with mating plugs with M23 standard knurled nuts



Panel feed-through, short



Panel feed-through, long

Description		Ordering data		Ordering data	
		Order No.	Pcs. / Pkt.	Order No.	Pcs. / Pkt.
Cable clamping area		5+PE-pos.		4+3+PE-pos.	
Panel feed-through, short with contact carrier, without contacts, for cable Ø 7.5 to 14 mm, connection cross section up to 2.5 mm ²					
Universal gasket	7.5 mm ... 14 mm	1605517	1	1607051	1
	7.5 mm ... 9 mm	1605516	1	1607048	1
	9 mm ... 11 mm	1607037	1	1607049	1
	11 mm ... 14 mm	1607038	1	1607050	1
Panel feed-through, long with contact carrier, without contacts, for cable Ø 7.5 to 18 mm, connection cross section up to 4 mm ²					
Universal gasket	7.5 mm ... 18 mm			1605518	1
	7.5 mm ... 9 mm			1607042	1
	9 mm ... 12 mm			1607041	1
	12 mm ... 15 mm			1607040	1
	15 mm ... 18 mm			1607039	1
Accessories		Accessories		Accessories	
Crimp contacts		For pin contacts, see page 136		For pin contacts, see page 136	
Color rings, 50 pcs. in set (to be ordered separately)		See page 164		See page 164	

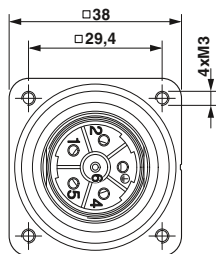

Flange dimensions for short and long design

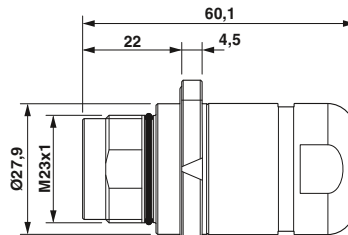

Short design

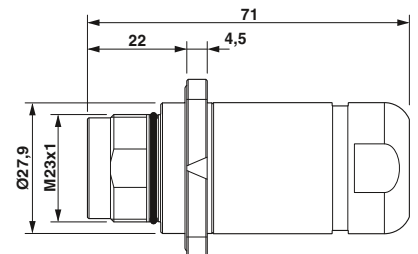

Long design

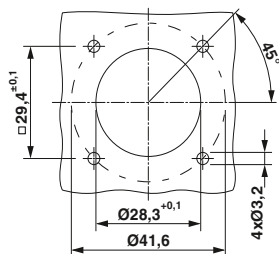

Installation dimensions for short and long design

Panel feed-through, fully wired

- Front mounting
- Internally fully wired and fitted with contacts
- Compatible with mating plugs with M23 standard knurled nuts



Panel feed-through,
pin/socket

Ordering data

Description	Order No.	Pcs. / Pkt.	Order No.	Pcs. / Pkt.
	Panel feed-through, pin inside - socket outside, fully wired	5+PE-pos.		4+3+PE-pos.
	1605492	1	1605567	1

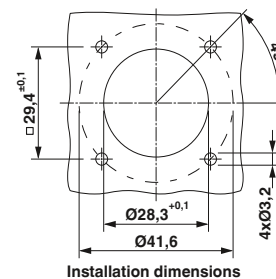
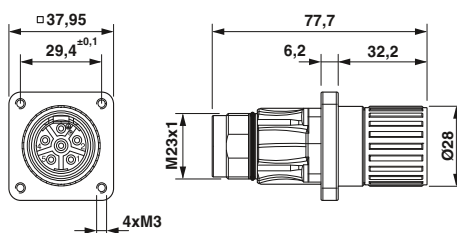

Connectors

M23 - power connectors

Crimp contacts, turned

The 6-pos. (5+PE) versions are assembled with 2 mm Ø contacts. The 8-pos. (4+3+PE) versions are equipped with four 1 mm Ø signal contacts and four 2 mm Ø contacts.

Note: observe the crimp ranges for cable and coupler connectors.

- Short version: connection cross sections up to 2.5 mm², max. cable diameter of 14 mm
- Long version: connection cross sections up to 4 mm², max. cable diameter of 18 mm



Crimp contacts, socket



Crimp contacts, pin

		Ordering data			Ordering data		
Description	Connection cross section [mm ²]	Type	Order No.	Pcs. / Pkt.	Type	Order No.	Pcs. / Pkt.
Contacts, socket Ø 2.0 mm for cable and device connectors with knurled nuts, power and PE contacts							
	0.25 ... 1.0	SF-7PS2000	1605636	50			
	0.75 ... 1.5	SF-7NS2000	1605631	50			
	1.0 ... 2.5	SF-7QS2000	1605643	50			
	4.0	SF-7MS2000	1605628	50			
Contacts, socket Ø 1.0 mm for cable and device connectors with knurled nuts, signal contacts							
	0.06 ... 0.2	SF-6CS2000	1605562	100			
	0.14 ... 0.5	SF-10KS004	1607356	100			
	0.5 ... 1.0	SF-6AS2000	1605557	100			
Contacts, pin Ø 2.0 mm for coupler connectors, power and PE contacts							
	0.14 ... 0.25				SF-7RP2000	1605646	50
	0.25 ... 1.0				SF-7PP2000	1605634	50
	0.75 ... 1.5				SF-20KP004	1607376	50
	1.0 ... 2.5				SF-7QP2000	1605639	50
	4.0				SF-7MP2000	1605626	50
Contacts, pin Ø 1.0 mm for coupler connectors, signal contacts							
	0.06 ... 0.2				SF-6CP2000	1605559	100
	0.14 ... 0.5				SF-10KP004	1607355	100
	0.5 ... 1.0				SF-6AP2000	1605554	100
Contacts, pin Ø 2.0 mm for device connectors, power and PE contacts							
	0.14 ... 0.25				SF-7RP2000	1605646	50
	0.25 ... 1.0				SF-7PP2000	1605634	50
	0.75 ... 1.5				SF-20KP004	1607376	50
	1.0 ... 2.5				SF-7QP2000	1605639	50
	4.0				SF-7MP2000	1605626	50
Contacts, pin Ø 1.0 mm for device connectors, signal contacts							
	0.06 ... 0.2				SF-6CP2000	1605559	100
	0.14 ... 0.5				SF-10KP004	1607355	100
	0.5 ... 1.0				SF-6AP2000	1605554	100
		Accessories			Accessories		
Crimping tools		Order separately, see page 159 onwards			Order separately, see page 159 onwards		

Contact diameter

Number of positions	Number of contacts	Contact Ø [mm]
6(5+PE)	5+PE	2+2
8(4+3+PE)	4+3+PE	1+2+2

Mechanical and electrical data

Mechanical data	
Housing material:	Copper zinc alloy (CuZn), die-cast zinc (GD-Zn)
Housing surface:	Nickel-plated/thick layer passivated (can be coated)
Insulating body:	Polyamide (PA 66)
Contact material:	Copper zinc alloy (CuZn)
Contact surface:	Nickel-plated (Ni) with gold coating (Au)
Contact connection method:	Crimp version
Sealing and O-ring:	Fluorocarbon rubber (FKM)
Ambient temperature:	-40°C ... 125°C
Cable entry:	Cable outside diameter of 9.0 - 26.5 mm, shielded
Type of locking:	M40 SPEEDCON fast locking system, cable connector with M40 x 1.5 coarse-pitch thread as an option
Mech. insertion/withdrawal cycles:	Standard: 50
Protection class	IP67 in the locked state

Electrical data													
Number of positions	6 (2+3+PE)			8 (4+3+PE)									
	2	+	3	+	PE	4	+	3	+	PE			
Contacts													
Contact Ø	[mm]	2.0		3.6		3.6		2.0		3.6		3.6	
Litz wire cross sections													
Cable and coupler connectors	[mm²]	0.14 ... 4.0		0.75 ... 10		0.75 ... 10		0.14 ... 4.0		0.75 ... 10		0.75 ... 10	
Device connectors	[mm²]	0.14 ... 4.0		0.75 ... 10		0.75 ... 10		0.14 ... 4.0		0.75 ... 10		0.75 ... 10	
Nominal current per contact at 25°C ¹⁾	[A]	30		70		–		30		70		–	
Specifications according to DIN EN 61984:2009													
Rated voltage	[V AC/DC]	250		630		–		250		630		–	
Test/surge voltage	[kV]	4		6		–		4		6		–	
Surge voltage category		III			III			III			III		
Pollution degree		3			3			3			3		
Installation height	[m]	Up to 3000			Up to 3000			Up to 3000			Up to 3000		
Cable clamping area ²⁾	Max. Ø [mm]	26.5			26.5			26.5			26.5		

¹⁾ The effective current carrying capacity must be determined using a derating curve, if necessary, according to the application.

²⁾ The cable clamping areas specified on the following pages may vary depending on the cable material/structure. Selection and testing is the responsibility of the user.

Contact chamber numbering
(view of plug-in side)

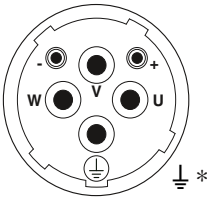
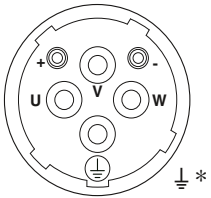
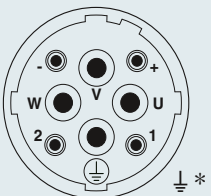
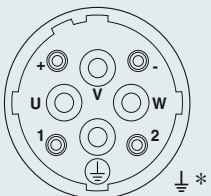
Number of positions	Pin	Socket
<p>6-pos. (2 + 3 + PE) Crimp</p>		
<p>8-pos. (4 + 3 + PE) Crimp</p>		

* with grounding spring

Connectors

M40 - power connectors

Selection guide

M40 power connectors up to 70 A/630 V, crimp ranges up to 16 mm²

- Cable connectors
- Coupler connectors
- Device connectors (device flanges)
- Feed-throughs/panel feed-throughs

The connectors are supplied fully assembled and are complemented by the respective crimp contacts.

M40 connectors with knurled nuts can be supplied with SPEEDCON fast locking system or with M40 x 1.5 coarse-pitch thread as an option.

The product chart provides an overview of the available components.

Connector type

Cable connectors

SPEEDCON fast locking system, see page 142.

Shielded



Mounting flange for wall mounting, see page 162.



M40 x 1.5 standard interlocking, see page 142.



Device connectors with knurled nut

Straight, see page 144.

Shielded



Angled, see page 145.



Coupler connectors

See page 142.

Shielded



Device connectors

Angled, rotatable, see page 146.

Straight, see page 143.



Crimp contacts

Tools/accessories

Socket contacts

Turned, see page 147.



Socket contacts

Crimping tools

Crimping pliers, see page 159.



Crimping pliers with digital display for turned crimp contacts, see page 159.



Pin contacts

Turned, see page 147.



Pin contacts

Accessories

Color rings for individually marking the connectors, see page 164.

**Note:**

For reasons of safety, only socket contacts may be used in the live part of the connector.

Connectors

M40 - power connectors

Cable connector

- SPEEDCON fast locking system or M40 standard interlocking
- Standard knurled nuts compatible with mating plugs with SPEEDCON or M40 standard external thread
- Individual marking of connectors with color rings



Cable connector, SPEEDCON



Cable connector

Description		Ordering data		Ordering data					
		Order No.	Pcs. / Pkt.	Order No.	Pcs. / Pkt.	Order No.	Pcs. / Pkt.		
Cable clamping area		2+3+PE-pos.		4+3+PE-pos.		2+3+PE-pos.		4+3+PE-pos.	
Cable connector housing, with contact carrier, without contacts, connection cross section up to 16 mm ²									
9 mm ... 14 mm		1613428	1	1613434	1	1613518	1	1613528	1
14 mm ... 20.5 mm		1613429	1	1613435	1	1613519	1	1613529	1
20.5 mm ... 26.5 mm		1613430	1	1613436	1	1613520	1	1613530	1
Crimp contacts		Accessories				Accessories			
		For socket contacts, see page 147 See page 164				For socket contacts, see page 147 See page 164			
Color rings, 50 pcs. in set (to be ordered separately)									

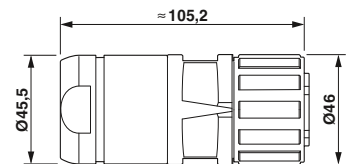
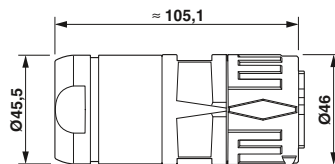

Coupler and device connector

- Compatible with mating plugs with SPEEDCON or M40 standard knurled nuts
- Individual marking of connectors with color rings



Coupling connector



Device connector, straight

Description	Cable clamping area	Ordering data				Ordering data			
		Order No.	Pcs. / Pkt.	Order No.	Pcs. / Pkt.	Order No.	Pcs. / Pkt.	Order No.	Pcs. / Pkt.
Coupler connector , with contact carrier, without contacts, connection cross section up to 16 mm ²	9 mm ... 14 mm	1613425	1	1613431	1	1613517	1	1613527	1
	14 mm ... 20.5 mm	1613426	1	1613432	1				
	20.5 mm ... 26.5 mm	1613427	1	1613433	1				
Device connector, straight , with contact carrier, without contacts	Connection cross section up to 10 mm ²								
Crimp contacts		Accessories				Accessories			
Color rings, 50 pcs. in set (to be ordered separately)		For pin contacts, see page 147 See page 164				For pin contacts, see page 147 See page 164			

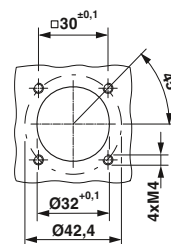
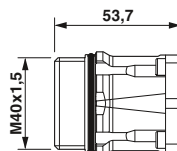
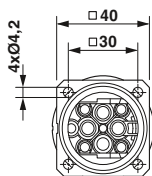
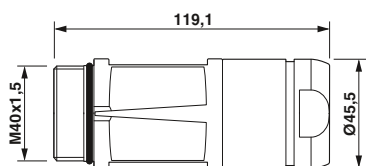

Installation dimensions

Connectors

M40 - power connectors

Device connector with knurled nut

- SPEEDCON fast locking system or M40 standard interlocking
- Standard knurled nuts compatible with mating plugs with SPEEDCON or M40 standard external thread
- Device connectors with knurled nuts must be fitted with socket contacts.



Device connector with knurled nut, straight, SPEEDCON



Device connector with knurled nut, straight

Description	Ordering data				Ordering data			
	Order No.	Pcs. / Pkt.	Order No.	Pcs. / Pkt.	Order No.	Pcs. / Pkt.	Order No.	Pcs. / Pkt.
Device connector with SPEEDCON knurled nut, straight, with contact carrier, without contacts Connection cross section up to 16 mm ²	1613524	1	1613534	1	1605823	1	1605865	1
Device connector with standard knurled nut, straight, with contact carrier, without contacts Connection cross section up to 16 mm ²								
Accessories		Accessories		Accessories		Accessories		
Crimp contacts Color rings, 50 pcs. in set (to be ordered separately)		For socket contacts, see page 147 See page 164		For socket contacts, see page 147 See page 164		For socket contacts, see page 147 See page 164		

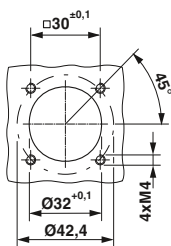

Installation dimensions

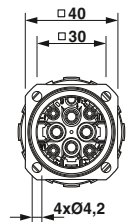
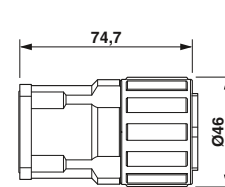
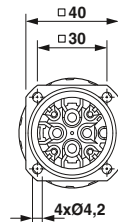
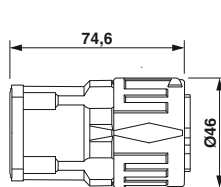

Device connector with knurled nut

Device connectors with knurled nuts must be equipped with socket contacts.



Device connector with knurled nut, angled, SPEEDCON



Device connector with knurled nut, angled

Ordering data			
Order No.	Pcs. / Pkt.	Order No.	Pcs. / Pkt.

Ordering data			
Order No.	Pcs. / Pkt.	Order No.	Pcs. / Pkt.

1613525	1	1613535	1
---------	---	---------	---

1607532	1	1607543	1
---------	---	---------	---

Accessories	
For socket contacts, see page 147	
See page 164	

Accessories	
For socket contacts, see page 147	
See page 164	

Description
Device connector with SPEEDCON knurled nut, angled, with contact carrier, without contacts
Connection cross section up to 16 mm ²
Device connector with knurled nut, angled, with contact carrier, without contacts
Connection cross section up to 16 mm ²
Crimp contacts
Color rings, 50 pcs. in set (to be ordered separately)

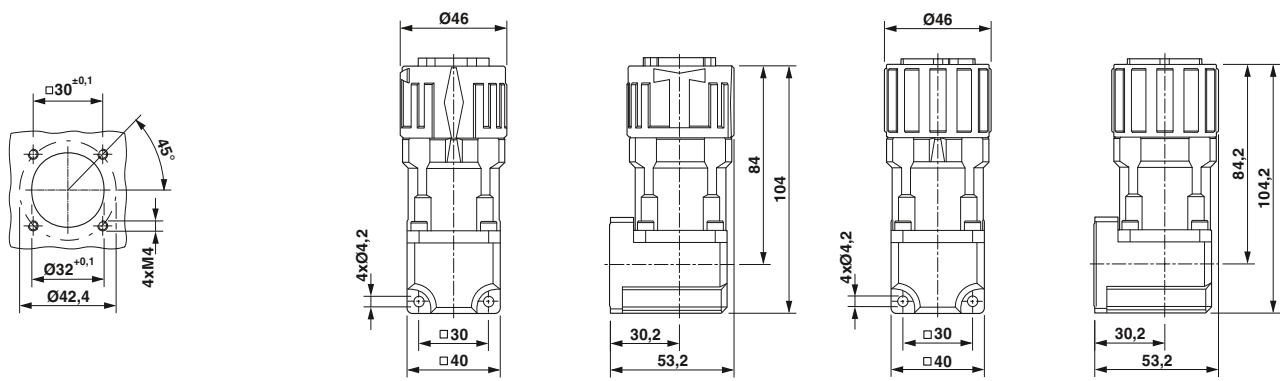

Installation dimensions

Connectors

M40 - power connectors

Device connector, angled, rotatable

- Compatible with mating plugs with SPEEDCON or M40 standard knurled nuts
- The rotatable angled housing can be rotated freely through 310°.
- Individual marking of connectors with color rings



Device connector,
angled rotatable

Ordering data

Description	Order No.	Pcs. / Pkt.	Order No.	Pcs. / Pkt.
	Device connector, angled, rotatable, with contact carrier, without contacts Connection cross section up to 10 mm ²	1620663	1	1620664

Accessories

Crimp contacts	For pin contacts, see page 147
Color rings, 50 pcs. in set (to be ordered separately)	See page 164

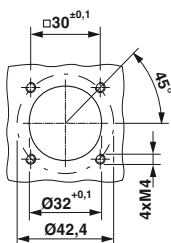

Installation dimensions

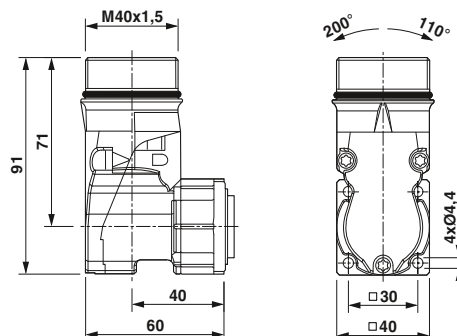

Crimp contacts, turned

The 6-pos. (2+3+PE) versions are equipped with two Ø 2 mm signal contacts and four 3.6 mm contacts (three power, 1 PE contact).

The 8-pos. (4+3+PE) versions are equipped with four 2 mm signal contacts and four 3.6 mm contacts (three power, 1 PE contact).

Note: depending on the litz wire used, the connection cross sections (crimp ranges) can differ from the values mentioned below.



Crimp contacts, socket



Crimp contacts, pin

		Ordering data			Ordering data		
Description	Connection cross section [mm²]	Type	Order No.	Pcs. / Pkt.	Type	Order No.	Pcs. / Pkt.
Contacts, socket Ø 3.6 mm, for cable and device connectors with knurled nuts, power and PE contacts							
	1.0 ... 2.5	SM-36KS001	1605756	20			
	2.5 ... 4.0	SM-36KS002	1605758	20			
	4.0 ... 6.0	SM-36KS003	1605760	20			
	6.0 ... 10.0	SM-36KS004	1605762	20			
Contacts, socket Ø 2.0 mm, for cable and device connectors with knurled nuts, signal contacts							
	0.25 ... 1.0	SF-7PS2000	1605636	50			
	0.75 ... 1.5	SF-7NS2000	1605631	50			
	1.0 ... 2.5	SF-7QS2000	1605643	50			
	4.0	SF-7MS2000	1605628	50			
Contacts, pin Ø 3.6 mm, for coupler connectors, power and PE contacts							
	1.0 ... 2.5				SM-36KP005	1605749	20
	2.5 ... 4.0				SM-36KP006	1605750	20
	4.0 ... 6.0				SM-36KP008	1605754	20
	6.0 ... 10.0				SM-36KP007	1605752	20
Contacts, pin Ø 2.0 mm, for coupler connectors, signal contacts							
	0.25 ... 1.0				SM-20KP006	1605738	50
	0.75 ... 1.5				SM-20KP005	1605736	50
	1.0 ... 2.5				SM-20KP007	1605739	50
	4.0				SM-20KP008	1605741	50
Contacts, pin Ø 3.6 mm, for device connectors, power and PE contacts							
	0.75 ... 1.5				SM-36KP001	1605743	20
	1.0 ... 2.5				SM-36KP009	1607057	20
	1.0 ... 4.0				SM-36KP002	1605744	20
	4.0 ... 6.0				SM-36KP003	1605745	20
	6.0 ... 10.0				SM-36KP004	1605747	20
Contacts, pin Ø 2.0 mm, for device connectors, signal contacts							
	0.14 ... 0.25				SF-7RP2000	1605646	50
	0.25 ... 1.0				SF-7PP2000	1605634	50
	0.75 ... 1.5				SF-20KP004	1607376	50
	1.0 ... 2.5				SF-7QP2000	1605639	50
	4.0				SF-7MP2000	1605626	50
				Accessories			
Crimping tools				Order separately, see page 159			
				Accessories			
				Order separately, see page 159			

Number of positions	Number of contacts	Contact Ø [mm]
6(2+3+PE)	2+3+PE	2+3.6+3.6
8(4+3+PE)	4+3+PE	2+3.6+3.6

Mechanical and electrical data

Mechanical data

Housing material:	Aluminum
Housing surface:	Aluminum, anodized
Insulating body:	Polyamide (PA 66)
Contact surface:	Power and PE contacts: silver-plated (Ag), signal contacts: gold-plated (Au)
Contact connection method:	Crimp version
Sealing and O-ring:	Fluorocarbon rubber (FPM)
Ambient temperature:	-40°C ... 120°C
Cable entry:	Cable and coupler connectors for cable outside diameter of 17 - 36 mm, shielded
Type of locking:	M58 x 2 screw locking
Mech. insertion/withdrawal cycles:	Standard: 100
Protection class:	IP67 in the locked state

Electrical data

Number of positions	6 (2+3+PE)			8 (4+3+PE)		
	2	3	PE	4	3	PE
Contacts	2	3	PE	4	3	PE
Contact Ø [mm]	1.6	10	10	1.6	10	10
Litz wire cross section						
Crimp contacts, turned [mm ²]	0.75 ... 1.5	10 ... 50	10 ... 50	0.75 ... 1.5	10 ... 50	10 ... 50
Nominal current per contact at 25°C ¹⁾ [A]	12	150	–	12	150	–
Specifications according to DIN EN 61984:2009						
Rated voltage [V AC/DC]	250	630	–	250	630	–
Test/surge voltage [kV AC]	4	6	–	4	6	–
Surge voltage category		III			III	
Pollution degree		3			3	
Installation height [m]		Up to 2000			Up to 2000	
Cable clamping area ²⁾ Max. Ø [mm]		36			36	

¹⁾ The effective current carrying capacity must be determined using a derating curve, if necessary, according to the application.

²⁾ The cable clamping areas specified on the following pages may vary depending on the cable material/structure. Selection and testing is the responsibility of the user.

Note:

Unlike plug-in devices, connectors may only be inserted or removed when disconnected from the power.

Pin assignments and coding

Contact chamber numbering
(view of plug-in side)

Number of positions	Pin	Socket
<p>6-pos. (2 + 3 + PE) Crimp</p>		
<p>8-pos. (4 + 3 + PE) Crimp</p>		

* with grounding spring,
PE leading

Connectors

M58 - power connectors

Selection guide

M58 power connectors up to 150 A/630 V, crimp ranges up to 50 mm²

- Cable connectors
- Coupler connectors
- Device connectors, straight

The power connectors are supplied fully assembled and are complemented by the respective crimp contacts.

The product chart provides an overview of the available components.

Connector type

Cable connectors

Shielded

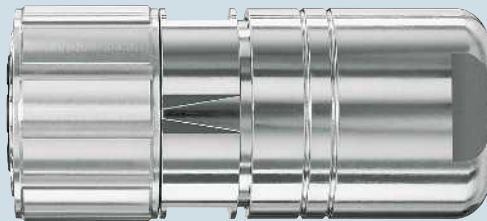

See page 152.

Coupler connectors

Shielded



See page 152.

Device connectors

Shielded



See page 153.

Crimp contacts

Socket contacts

Turned, see page 154.



Socket contacts

Pin contacts

Pin contacts

Pin contacts

Turned, see page 154.



Tools/accessories

Crimping tools

Crimping device for power and PE contacts
Ø 10 mm,
see page 160.



Crimping pliers for signal contacts Ø 1.6 mm,
see page 160.

**Note:**

For reasons of safety, only socket contacts may be used in the live part of the connector.

Connectors

M58 - power connectors

Cable and coupler connector

- High transmission capacities of up to 630 V and 150 A
- Connection cross sections up to 50 mm²
- Cable clamping area from 17 mm to 36 mm



Cable connector



Coupling connector

Description		Ordering data				Ordering data			
		Order No.	Pcs. / Pkt.	Order No.	Pcs. / Pkt.	Order No.	Pcs. / Pkt.	Order No.	Pcs. / Pkt.
Cable clamping area	17 mm ... 25 mm								
	25 mm ... 36 mm								
Connector housing, with contact carrier, without contacts, for cable diameter:									
	17 mm ... 25 mm	1607503	1	1607508	1	1607500	1	1607506	1
	25 mm ... 36 mm	1607501	1	1607507	1	1607499	1	1607505	1
		Accessories				Accessories			
Crimp contacts		For socket contacts, see page 154				For pin contacts, see page 154			

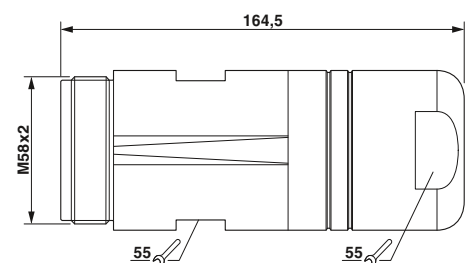
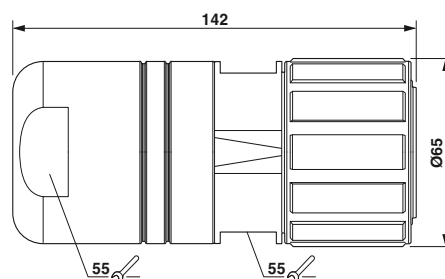

Device connector for front mounting

Coupler and device connectors must be fitted with pin contacts, cable connectors must be fitted with socket contacts.



Device connector,
straight

Description	Ordering data			
	Order No.	Pcs. / Pkt.	Order No.	Pcs. / Pkt.
Device connector, straight, with contact carrier, without contacts	2+3+PE-pos.		4+3+PE-pos.	
	1615686	1	1615687	1
Accessories				
Crimp contacts	For pin contacts, see page 154			

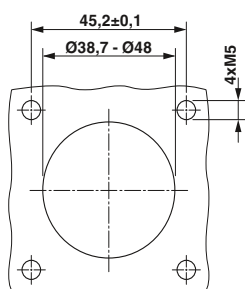

Installation dimensions

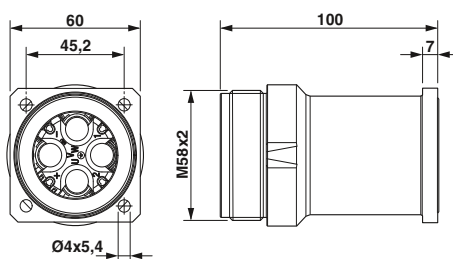

Connectors

M58 - power connectors

Crimp contacts, turned

The 6-pos. (2+3+PE) versions are equipped with two Ø 1.6 mm signal contacts and four 10 mm contacts (three power, 1 PE contact).

The 8-pos. (4+3+PE) versions are equipped with four 1.6 mm signal contacts and four 10 mm contacts (three power, 1 PE contact).

Note: depending on the litz wire used, the connection cross sections (crimp ranges) can differ from the values mentioned below.



Crimp contacts, socket



Crimp contacts, pin

		Ordering data			Ordering data		
Description	Connection cross section [mm ²]	Type	Order No.	Pcs. / Pkt.	Type	Order No.	Pcs. / Pkt.
Contacts, socket Ø 10.0 mm for cable connectors, power and PE contacts	10.0	SL-1CKS010	1607916	4			
	16.0	SL-1CKS020	1607917	4			
	25.0	SL-1CKS030	1607918	4			
	35.0	SL-1CKS040	1607919	4			
	50.0	SL-1CKS050	1607920	4			
Contacts, socket Ø 1.6 mm for cable connectors, signal contacts	0.75 ... 1.5	SL-16KS010	1607956	4			
Contacts, pin Ø 10.0 mm for coupler and device connectors, power and PE contacts	10.0				SL-1CKP010	1607911	4
	16.0				SL-1CKP020	1607912	4
	25.0				SL-1CKP030	1607913	4
	35.0				SL-1CKP040	1607914	4
	50.0				SL-1CKP050	1607915	4
Contacts, pin Ø 1.6 mm for coupler and device connectors, signal contacts	0.75 ... 1.5				SL-16KP010	1607909	4
		Accessories			Accessories		
Crimping tools		Order separately, see page 160 onwards			Order separately, see page 160 onwards		

Number of positions	Number of contacts	Contact Ø [mm]
6(2+3+PE)	2+3+PE	1.6+10+10
8(4+3+PE)	4+3+PE	1.6+10+10

Connectors

Tools and accessories

Tools and accessories for M23 signal connectors

For RC crimp contacts, RC-Z2130 and RC-Z2514 crimping pliers are used for rolled or turned crimp contacts.

RC-Z2514 crimping pliers with 4-arbor pressing are suitable for crimping turned RC contacts. Detailed operating instructions are included in the packaging.



Crimping tools for rolled/turned contacts



Contact insertion/unlocking tool

Description	Ordering data			Ordering data		
	Type	Order No.	Pcs. / Pkt.	Type	Order No.	Pcs. / Pkt.
Crimping pliers for rolled RC crimp contacts Ø 1 mm Litz wire cross section 0.08 ... 0.56 mm ²	RC-Z2130	1604267	1			
Crimping pliers for turned RC crimp contacts Ø 1 mm / Ø 1.5 mm / Ø 2 mm Litz wire cross section of 0.08 ... 2.5 mm ²	RC-Z2514	1614590	1			
Insertion and unlocking tool for RC crimp contacts Socket/pin Ø 1 mm Socket/pin Ø 1.5 mm Socket/pin Ø 2 mm				RC-Z2494	1614123	1
				RC-Z2274	1604409	1
				RC-Z2490	1611803	1

Tools and accessories

Crimping tools for punched-rolled C-HC crimp contacts

The manual crimping pliers are suitable for single processing. For processing taped products, a bench-mounted electric crimping device with integrated feed mechanism is available.

- The SF-Z0041 adapter enables tools for the manual crimping pliers for single processing to be used with the electric crimping device.



Hand crimping tools for punched-rolled C-HC crimp contacts



Electrical crimp device for punched-rolled C-HC crimp contacts

Description	Ordering data			Ordering data		
	Type	Order No.	Pcs. / Pkt.	Type	Order No.	Pcs. / Pkt.
Hand crimping pliers , basic tool for individual processing						
for C-HC crimp contacts	SF-Z0029	1607458	1			
Tool head for crimping pliers SF-Z0029 , for C-HC crimp contacts						
Contacts Ø 2 mm	SF-Z0030	1607459	1			
Contacts Ø 1 mm	SF-Z0031	1607461	1			
Electric crimping device , for processing taped products						
for C-HC crimp contacts				SF-Z0032	1607462	1
Tool head for electrical crimp device SF-Z0032 , for C-HC crimp contacts, processing for taped articles						
Contacts Ø 2.0 mm / connection 1.0 mm ²				SF-Z0033	1607463	1
Contacts Ø 2.0 mm / connection 1.5 mm ²				SF-Z0047	1614689	1
Contacts Ø 2.0 mm / connection 2.5 mm ²				SF-Z0035	1607465	1
Contacts Ø 1.0 mm / connection 0.08 ... 0.2 mm ²				SF-Z0039	1607470	1
Contacts Ø 1.0 mm / connection 0.2 ... 0.56 mm ²				SF-Z0040	1607471	1
Media hub for elec. crimping device SF-Z0032 for accommodating rolls up to Ø 60 cm						
				SF-Z0052	1615413	1
Adapter for electrical crimp device SF-Z0032 , for accommodating tool heads for single processing						
				SF-Z0041	1607472	1

Crimping tools for turned contacts

The crimping pliers are suitable for crimping turned contacts with \varnothing 0.6 mm, \varnothing 1 mm, \varnothing 2 mm, and \varnothing 3.6 mm (excl. M23 signal connectors). For large litz wire cross sections, a pneumatic crimping tool is available.

Notes:

For crimping tools for M23 signal connectors, see page 156



Manual crimping pliers



Crimping tool, pneumatic

Description	Litz wire cross section [mm ²]	Ordering data			Ordering data		
		Type	Order No.	Pcs. / Pkt.	Type	Order No.	Pcs. / Pkt.
Manual crimping pliers with digital display for turned crimp contacts with \varnothing 1 mm, \varnothing 2 mm, \varnothing 3.6 mm	0.06 ... 6	SF-Z0025	1607452	1			
Positioners for crimping the SF-6FS2000 / SF-6DP2000 contacts with a connection cross section of 1.5 mm ²		SF-Z0042	1613666	1			
Manual crimping pliers with digital display for turned crimp contacts with \varnothing 2 mm, \varnothing 3.6 mm	1.5 ... 10	SF-Z0026	1607454	1			
Manual crimping pliers with digital display for turned crimp contacts with \varnothing 0.6 mm, \varnothing 1 mm, \varnothing 2 mm	0.06 ... 2.5	SF-Z0054	1615585	1			
Crimping tool, pneumatic for turned crimp contacts \varnothing 3.6 mm	6.0 ... 16				SF-Z0014	1607446	1
Crimp head for crimping tool, pneumatic					SF-Z0003	1605657	1
Positioner for crimp head SF-Z0003, for device connectors					SF-Z0011	1605675	1
Positioner for crimp head SF-Z0003, for cable and coupler connectors	Marking "D" "F" marking				SF-Z0013	1605681	1

Connectors

Tools and accessories

Crimping tools for turned contacts for M58 power connectors

For turned crimp contacts with \varnothing 1.6 mm for M58 power connectors, SF-Z0025 manual crimping pliers are used.

For user-friendly crimping of contacts with \varnothing 10 mm, the SL-Z0007 electric crimping tool is available.

Crimping stamps for processing contacts with \varnothing 10 mm are used in pairs. The stamps are tailored to the connection cross sections and marked.



Electro-hydraulic crimping device



Manual crimping pliers

Description	Connection cross section [mm ²]	Ordering data			Ordering data		
		Type	Order No.	Pcs. / Pkt.	Type	Order No.	Pcs. / Pkt.
Electro-hydraulic crimping device incl. charger and rechargeable battery , for Litz wire cross section 10 ... 50 mm ² (power and PE contacts \varnothing 10 mm)		SL-Z0007	1613484	1			
Crimping stamp for crimping device SL-Z0007	10	SL-Z0011	1613488	1			
Crimping stamp for crimping device SL-Z0007	16	SL-Z0012	1613489	1			
Crimping stamp for crimping device SL-Z0007	25	SL-Z0013	1613490	1			
Crimping stamp for crimping device SL-Z0007	35	SL-Z0014	1613491	1			
Crimping stamp for crimping device SL-Z0007	50	SL-Z0015	1613492	1			
Crimping tool with digital display	0.06 ... 6				SF-Z0025	1607452	1
Accessories for electro-hydraulic crimping device SL-Z0007							
Replacement battery		SL-Z0008	1613485	1			
Table holder incl. foot actuation switch		SL-Z0010	1613487	1			

Notes:

The manual SF-Z0025 crimping pliers with digital display are also suitable for crimping turned ST/SF/SM crimp contacts.

Special wrench

The torque screwdriver is specially adapted to the M23 circular connectors and simplifies the process of tightening and loosening the knurled nut safely even in places where space is restricted.

The tool consists of a hook spanner as well as a torque screwdriver with a set torque of 2.5 Nm.



Torque screwdriver for M23 connectors with knurled nuts



Special screw key for screwing the adapter

		Ordering data			Ordering data		
Description	Wrench size [mm]	Type	Order No.	Pcs. / Pkt.	Type	Order No.	Pcs. / Pkt.
Torque screwdriver incl. hook wrench							
	For M23 connectors with knurled nuts	SF-Z0028	1607456	1			
Replacement hook spanner for torque screwdriver							
		SF-Z0027	1607455	1			
Special wrench for cable/coupler connectors for screwing the adapter. Connection dimensions for torque wrench: 8.9 mm x 11.9 mm							
	for M17 connectors, WAF 19				ST-Z0012	1613667	1
	for M23 connectors, WAF 24				RF-Z0007	1614347	1
	for M40 connectors, WAF 41				SM-Z0012	1614349	1
	for M58 connectors, WAF 55				SL-Z0016	1614348	1

Connectors

Tools and accessories

Unlocking tool, square mounting flange

The unlocking tool is used for those contact carriers which are snapped into the housing without rear support. They are removed from the plug-in side using the unlocking tool.

The square mounting flange is used for cable and coupling connectors. In this way, the product range is easily expanded with connectors as panel feed-throughs.



Unlocking tool for snap-in contact carriers



Square mounting flange for cable/coupling connector for wall mounting

		Ordering data			Ordering data		
Description	Wall mounting	Type	Order No.	Pcs. / Pkt.	Type	Order No.	Pcs. / Pkt.
Unlocking tool for contact carriers, device connectors							
	For M17 signal/power connectors	ST-Z0001	1607770	1			
	For M23 feedback connectors	RF-Z0001	1607904	1			
	For M23 signal connectors	CA-Z0001	1620699	1			
Square mounting flange, metal, with O-ring seal , for M17 (excl. M17 Compact) cable and coupler connectors for wall mounting							
	4 x Ø 2.7 mm				ST-Z0002	1607771	1
	4 x M3				ST-Z0003	1607772	1
Square mounting flange, metal, without seal , for M17 (excl. M17 Compact) cable and coupler connectors for wall mounting							
	4 x Ø 2.7 mm				ST-Z0004	1607773	1
	4 x M3				ST-Z0005	1607775	1
Square mounting flange, metal, with O-ring seal , for M23 feedback, cable, and coupler connectors for wall mounting							
	4 x M3				RF-Z0003	1607905	1
Square mounting flange, metal, with O-ring seal , for M40 cable and coupler connectors for wall mounting							
	4 x Ø 4.3 mm				SM-Z0003	1607935	1
Square mounting flange, metal, without seal , for M40 cable and coupler connectors for wall mounting							
	4 x Ø 4.3 mm				SM-Z0004	1607937	1

Installation dimensions for square mounting flanges

Type	Installation dimensions			Flange dimensions					
	A	B	C	D	E	F	G	H	J
ST-Z0002 ST-Z0003 ST-Z0004 ST-Z0005	4 x M2.5/∅ 3.2	∅ 22.9 +0.2	□ 22.6 ±0.1	∅ 21.6	□ 22.6 ±0.1	4 x M3/∅ 2.7	M2.5	□ 28.0 ±0.1	5
RF-Z0003	4 x ∅ 3.2	∅ 27.9 ±0.1	□ 28.3 ±0.1	∅ 26.2	□ 28.3 ±0.1	4 x M3	M3	□ 35.0	6
SM-Z0003 SM-Z0004	4 x M4/∅ 4.2	∅ 46.1 ±0.1	□ 42.4 ±0.1	∅ 45.0	□ 42.4 ±0.1	4 x ∅ 4.3	M3	□ 55.0 ±0.1	5.5

Note:

For insulating wall mounting, plastic mounting flanges are available on request.

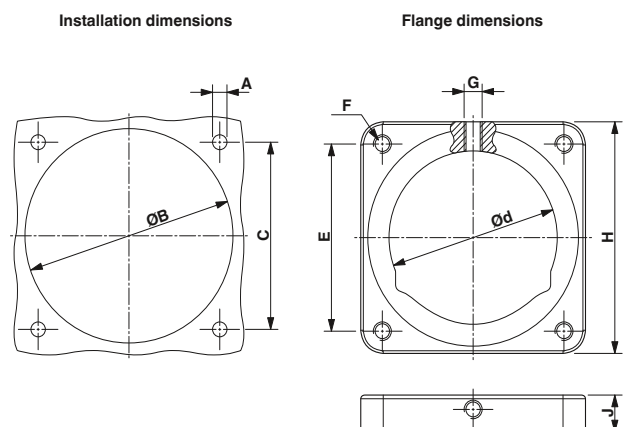

Connectors

Tools and accessories

Color rings

The color rings are used for individually marking the connectors



Color rings for marking connectors with cable entry



Color rings for marking device connectors

		Ordering data			Ordering data		
Description	Color	Type	Order No.	Pcs. / Pkt.	Type	Order No.	Pcs. / Pkt.
Color rings for M17 connectors, 50 pcs. in set							
	Green	ST-Z0016	1617993	50	ST-Z0019	1620621	50
	Orange	ST-Z0017	1618049	50	ST-Z0020	1620622	50
	Black	ST-Z0018	1618050	50	ST-Z0021	1620623	50
Color rings for M23 signal connectors, 50 pcs. in set							
	Green	RF-Z0014	1620588	50			
	Orange	RF-Z0015	1620592	50			
	Black	RF-Z0016	1620593	50			
Color rings for M23 signal device connectors, front mounting, Pg13.5 and M20 fastening thread/rear mounting, central fastening thread, 50 pcs. in set							
	Green				CA-Z0110	1620700	50
	Orange				CA-Z0111	1620701	50
	Black				CA-Z0112	1620702	50
Color rings for M23 signal device connectors, front mounting, flange dimensions: 25 mm x 25 mm, 50 pcs. in set							
	Green				CA-Z0120	1620704	50
	Orange				CA-Z0121	1620705	50
	Black				CA-Z0122	1620706	50
Color rings for M23 feedback connectors and M23 signal device connectors, angled, rotatable, 50 pcs. in set							
	Green	RF-Z0014	1620588	50	RF-Z0017	1620624	50
	Orange	RF-Z0015	1620592	50	RF-Z0018	1620625	50
	Black	RF-Z0016	1620593	50	RF-Z0019	1620626	50
Color rings for M23 hybrid and power connectors, 50 pcs. in set							
	Green	SF-Z0064	1620585	50	RF-Z0017	1620624	50
	Orange	SF-Z0065	1620586	50	RF-Z0018	1620625	50
	Black	SF-Z0066	1620587	50	RF-Z0019	1620626	50
Color rings for M40 connectors, 50 pcs. in set							
	Green	SM-Z0025	1620558	50	SM-Z0028	1620627	50
	Orange	SM-Z0026	1620559	50	SM-Z0029	1620628	50
	Black	SM-Z0027	1620560	50	SM-Z0030	1620629	50



Dust protection caps, plastic

A range of protective caps is available for signal connectors and power connectors to protect the contact elements in the case of a separate plug connection.

These prevent penetration of dust and humidity.

Plastic protective caps enable IP40 degree of protection when locked.



Plastic dust protection caps

Description	Degree of protection when locked	Ordering data		
		Type	Order No.	Pcs. / Pkt.
Plastic dust protection cap, for signal connector/power connector, with M17 external thread	IP40	ST-Z0006	1607776	25
Plastic dust protection cap, for signal connector/power connector, with M17 knurled nut (SPEEDCON and standard)	IP40	ST-Z0007	1607777	25
Plastic dust protection cap with lug for signal/power connectors with M23 external thread	IP40	SF-Z0019	1607449	25
Plastic dust protection cap, for signal connector/power connector, with M23 knurled nut	IP40	RC-Z2058	1604223	25
Plastic dust protection cap, for signal connector/power connector, with M23 external thread	IP40	RC-Z2059	1604225	25
Plastic dust protection cap, anti-static, black, for signal connector/power connector, with M23 knurled nut	IP40	RC-Z2468	1611796	25
Plastic dust protection cap, anti-static, black, for signal/power connectors with M23 external thread	IP40	RC-Z2469	1611797	25
Plastic dust protection cap for power connectors with M40 external thread	IP40	SM-Z0001	1605866	25
Plastic dust protection cap for power connectors with M58 external thread	IP40	SL-Z0005	1607926	25

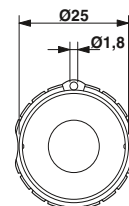

SF-Z0019, eye for fixing rope

Dust protection caps, metal

Metal protective caps are available for higher demands as regards the degree of protection. These enable IP67 when locked.

The wire is fixed to the housing panel and prevents the metal protective caps from being lost.



Metal dust protection caps

		Ordering data		
Description	Degree of protection when locked	Type	Order No.	Pcs. / Pkt.
Metal dust protection cap , for power connectors with M23 external thread	IP67	SC-Z2319	1605456	10
Metal dust protection cap with steel wire , for power connectors with M23 external thread	IP67	SC-Z2320	1605457	10
Metal dust protection cap with steel wire , for power connectors with M23 knurled nut	IP67	SC-Z2322	1605459	10
Metal dust protection cap , for signal connector, with M23 external thread	IP67	RC-Z2104	1604260	10
Metal dust protection cap with steel wire , for signal connectors with M23 external thread	IP67	RC-Z2068	1604236	10
Metal dust protection cap with steel wire , for signal connector, with M23 knurled nut	IP67	RC-Z2062	1604228	10



Sensor/actuator cabling

A one-stop-shop for the entire range of solutions for field installation

With distributed connection technology, passive distributor systems connect the I/O devices to the PLC controller.

Phoenix Contact offers the most comprehensive range of sensor/actuator cabling on the market. Passive M5, M8, M12, and 7/8" components consisting of distributor boxes, cables, and connectors for assembly are available from stock. A comprehensive range of valve connectors rounds off the entire range.

The 1/2" and 7/8" range for the North American market can be found on our website.

Customer/sector-specific solutions

In order to be able to respond flexibly to your needs, cables and boxes can be manufactured to suit with specific cable lengths and types (e.g., a different sheath color).

For increased requirements, such as the railway or food industry, the long-term use of products outdoors and cables for flexible use in drag chains or robot applications, Phoenix Contact offers a range of suitable product series.

Faster assembly with the SPEEDCON fast locking system

SPEEDCON is the logical development of the M12 connector system that has been established and accepted for many years. Following the principle of "Plug & Turn", the connection time for M12 connectors is reduced by 90%.

Due to the 100% compatibility, redundant warehousing is eliminated.

Assembled cables

3-pos. cables with connectors	170
4-pos. cables with connectors	180
5-pos. cables with connectors	186
6-pos. cables with connectors	191
8-pos. cables with connectors	193
12/17-pos. cables with connectors	198
Assembled M17 to M40 cables	202
Cables with valve connectors	214

Distributors and adapters	234
----------------------------------	------------

Distributor boxes	246
--------------------------	------------

Cabling for the railway industry	256
---	------------

Cabling for the food industry	258
--------------------------------------	------------

Cabling for outdoor applications	260
---	------------

Cabling for robots and drag chains	262
---	------------

Cabling for power applications	264
---------------------------------------	------------

By the meter - cable rings, cable drums	282
--	------------

Accessories	286
--------------------	------------

Cable range	298
--------------------	------------

Sensor/actuator cabling





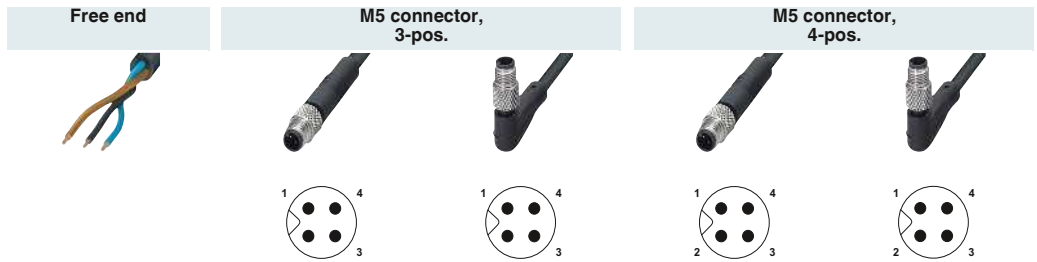

Assembled cables

M5 SAC cable, 3 and 4-pos., cable type: PUR/PVC

Notes:
For information about the cable qualities, see page 298



Free end	Ordering data		Ordering data		Ordering data		Ordering data		Ordering data			
	Order No.		Order No.		Order No.		Order No.		Order No.			
		1.5 m	1530265		1.5 m	1530346		1.5 m	1530304		1.5 m	1530388
		3 m	1530278		3 m	1530359		3 m	1530317		3 m	1530391
		5 m	1530281		5 m	1530362		5 m	1530320		5 m	1530401
		10 m	1530294		10 m	1530375		10 m	1530333		10 m	1530414
Socket M5, 3-pos., straight 		1.5 m	1530427									
		3 m	1530430									
		5 m	1530443									
		10 m	1530456									
Socket M5, 3-pos., angled 		1.5 m	1530508									
		3 m	1530511									
		5 m	1530524									
		10 m	1530537									
Socket M5, 4-pos., straight 		1.5 m	1530469									
		3 m	1530472									
		5 m	1530485									
		10 m	1530498									
Socket M5, 4-pos., angled 		1.5 m	1530540									
		3 m	1530553									
		5 m	1530566									
		10 m	1530579									

Cable description	Cable type	Color coding		Pin assignment 3-pos.		Color coding		Pin assignment 4-pos.	
		Color	Color	Pin	Pin	Color	Color	Pin	Pin
PUR/PVC - black	PUR M5	BN		1		BN		1	
		BK		4		WH		2	
		BU		3		BK		4	
						BU		3	

		Technical data	
		M5 3-pos.	M5 4-pos.
Rated voltage	[V]	125	125
Rated current	[A]	1	1
Contact material		CuZn	CuZn
Contact surface material		Au	Au
Material of grip body		PUR	PUR
M5 circular connector according to:		IEC 61076-2-105	IEC 61076-2-105
Degree of protection		IP65 / IP67 / IP68	IP65 / IP67 / IP68
Temperature data			
Connector/socket	[°C]	-25 ... 80	-25 ... 80

Sensor/actuator cabling

Assembled cables

M8 SAC cable, snap-in, 3 and 4-pos., cable type: PUR

Notes:
For information about the cable qualities, see page 298

Free end



M12 connector, 3-pos.

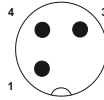

Ordering data

Ordering data

Ordering data

M8 socket, snap-in, 3-pos., straight

Order No.

Order No.

Order No.



5 m [1519875](#)
Variable [1697593](#)

Variable [1696853](#)

M8 socket, snap-in, 3-pos., angled



5 m [1519891](#)
Variable [1697629](#)

Variable [1696882](#)

M8 socket, snap-in, 3-pos., with LEDs, angled



Variable [1513402](#)

Variable [1515675](#)

M8 socket, snap-in, 4-pos., straight



Variable [1513389](#)

M8 socket, snap-in, 4-pos., angled



Variable [1513392](#)

M8 socket, snap-in, 4-pos., with LEDs, angled



Variable [1511954](#)

Information for products with fixed cable length:

Products with fixed cable length are produced with the halogen-free PUR cable type and are available from stock.

Ordering data for products with variable cable:

For a sensor/actuator cable, PUR, halogen-free, black, 4.5 m long, with a straight 3-pos. M12 connector and a straight M8 snap-in socket, the ordering data is as follows:

Order No.	Cable type	Length [m] Max. 40 m
1696853	PUR	4.5
Minimum order amount = 25		
Increments: 0.2 ... 3 m = 0.1 m > 3 m = 0.5 m		

Cable description	Cable type	Suitable for:	Color coding	Pin assignment 3-pos.
PUR, halogen-free - black E221474	PUR	3/4-pos.	BN BK	1 4
PUR, halogen-free - gray E221474	280	3-pos.	BU	3
TPE-U highly flexible - gray E221474	800	3/4-pos.		

Color coding	Pin assignment 4-pos.
BN	1
WH	2
BK	4
BU	3

With a combination of M12 and M8 connectors, the limiting M8 value applies to the rated voltage.

	Technical data	Technical data	Technical data	Technical data
	M8 3-pos.	M8 3-pos., with LEDs	M8 4-pos.	M8 4-pos., with LED
Rated voltage [V]	60	24	30	24
Rated current [A]	4	4	4	4
Contact material	CuSn	CuSn	CuSn	CuSn
Contact surface material	Ni/Au	Ni/Au	Ni/Au	Ni/Au
Material of grip body	TPU, hardly inflammable, self-extinguishing	TPU, hardly inflammable, self-extinguishing	TPU, hardly inflammable, self-extinguishing	TPU, hardly inflammable, self-extinguishing
M8 circular connector according to:	IEC 61076-2-104	IEC 61076-2-104	IEC 61076-2-104	IEC 61076-2-104
Degree of protection	IP65 / IP67 / IP68	IP65 / IP67 / IP68	IP65 / IP67 / IP68	IP65 / IP67 / IP68
Temperature data				
Connector/socket	-25 ... 90	-25 ... 90	-25 ... 90	-25 ... 90

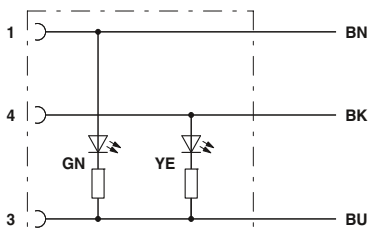

Contact assignment of the M8 socket with LED, 3-pos.

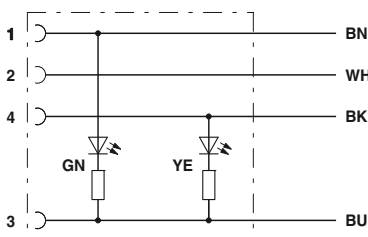

Contact assignment of the M8 socket with LED, 4-pos.

Sensor/actuator cabling

Assembled cables

M8 and M12 SAC cable, 3-pos., cable type: PUR

Notes:
For information about the cable qualities, see page 298

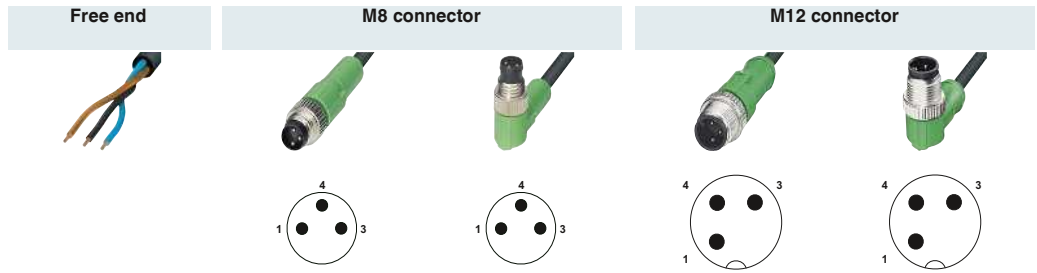

Free end	Ordering data		Ordering data		Ordering data		Ordering data		Ordering data		
	Order No.		Order No.		Order No.		Order No.		Order No.		
			1.5 m	1681664	1.5 m	1681693	1.5 m	1668014	1.5 m	1668137	
			3 m	1681677	3 m	1681703	3 m	1668027	3 m	1668140	
			5 m	1681680	5 m	1681716	5 m	1668030	5 m	1668153	
			10 m	1693584	10 m	1694114	10 m	1682566	10 m	1694444	
			Variable	1697548	Variable	1697551	Variable	1696662	Variable	1696675	
M8 socket, straight			1.5 m	1669712	0.3 m	1681907	0.3 m	1682029	0.3 m	1668797	
			3 m	1669725	0.6 m	1681910	0.6 m	1682032	0.6 m	1668807	
			5 m	1669628	1.5 m	1681923	1.5 m	1682045	1.5 m	1668810	
			10 m	1694101	3 m	1681936	3 m	1682058	3 m	1668823	
			Variable	1697580	Variable	1697632	Variable	1697661	Variable	1696840	
M8 socket, angled			1.5 m	1669738	0.3 m	1681949	0.3 m	1682061	0.3 m	1668836	
			3 m	1669741	0.6 m	1681952	0.6 m	1682074	0.6 m	1668849	
			5 m	1669631	1.5 m	1681965	1.5 m	1682087	1.5 m	1668852	
			10 m	1694169	3 m	1681978	3 m	1682090	3 m	1668865	
			Variable	1697603	Variable	1697645	Variable	1697674	Variable	1696866	
M8 socket, angled, with 2 LEDs			1.5 m	1671069	0.3 m	1681981	0.3 m	1682100	0.3 m	1694884	
			3 m	1671072	0.6 m	1681994	0.6 m	1682113	0.6 m	1694897	
			5 m	1671085	1.5 m	1682003	1.5 m	1682126	1.5 m	1694907	
			10 m	1683594	3 m	1682016	3 m	1682139	3 m	1694910	
			Variable	1697616	Variable	1697658	Variable	1697687	Variable	1696879	
M12 socket, straight			1.5 m	1694486	0.3 m	1682304	0.3 m	1682388	0.3 m	1681509	
			3 m	1694499	0.6 m	1682317	0.6 m	1682391	0.6 m	1681512	
			5 m	1683510	1.5 m	1682320	1.5 m	1682401	1.5 m	1681525	
			10 m	1693034	3 m	1682333	3 m	1682414	3 m	1681538	
			Variable	1696688	Variable	1697690	Variable	1697726	Variable	1696756	
M12 socket, straight, pin 2 - 4 bridged			1.5 m	1668072				0.3 m	1668315	0.3 m	1668551
			3 m	1668085				0.6 m	1668328	0.6 m	1668564
			5 m	1668098				1.5 m	1668331	1.5 m	1668577
			10 m	1694208				3 m	1668344	3 m	1668580
			Variable	1696691				Variable	1696769	Variable	1696811
M12 socket, straight, with LED			1.5 m	1694185							
			3 m	1694198							
			5 m	1694787							
			10 m	1694790							
			Variable	1696701	Variable	1514197		Variable	1511802	Variable	1524763
M12 socket, angled			1.5 m	1694509	0.3 m	1682346	0.3 m	1682427	0.3 m	1681541	
			3 m	1694512	0.6 m	1682359	0.6 m	1682430	0.6 m	1681554	
			5 m	1694525	1.5 m	1682362	1.5 m	1682443	1.5 m	1681567	
			10 m	1694538	3 m	1682375	3 m	1682456	3 m	1681570	
			Variable	1696714	Variable	1697700	Variable	1697739	Variable	1696772	
M12 socket, angled, pin 2 - 4 bridged			1.5 m	1668195				0.3 m	1668399	0.3 m	1668632
			3 m	1668205				0.6 m	1668409	0.6 m	1668645
			5 m	1668218				1.5 m	1668412	1.5 m	1668658
			10 m	1681017				3 m	1668425	3 m	1668661
			Variable	1696727				Variable	1696785	Variable	1696824
M12 socket, angled with LED			1.5 m	1694392	0.3 m	1693351	0.3 m	1682469	0.3 m	1694554	
			3 m	1694402	0.6 m	1693364	0.6 m	1682472	0.6 m	1694567	
			5 m	1694415	1.5 m	1693380	1.5 m	1682485	1.5 m	1694570	
			10 m	1694428	3 m	1693403	3 m	1682498	3 m	1694583	
			Variable	1696730	Variable	1697713	Variable	1697742	Variable	1696798	
M12 socket, angled, with LED, pin 2 - 4 bridged			1.5 m	1668250				0.3 m	1668438		
			3 m	1668263				0.6 m	1668441		
			5 m	1668276				1.5 m	1668454		
			10 m	1681059				3 m	1668467		
			Variable	1696743				Variable	1696808	Variable	1696837

Information for products with fixed cable length:

Products with fixed cable length are produced with the halogen-free PUR cable type and are available from stock.

Ordering data for products with variable cable:

For a sensor/actuator cable, PUR, halogen-free, black, 4.5 m long, with a straight 3-pos. M12 connector and a straight M12 socket, the ordering data is as follows:

Order No.	Cable type	Length [m] Max. 40 m
1696756	PUR	4.5
Minimum order amount = 25		
Increments: 0.2 ... 3 m = 0.1 m > 3 m = 0.5 m		

Cable description	Cable type	Suitable for:
PUR, halogen-free - black E221474	PUR	M8/M12
PUR, halogen-free - gray E221474	280	M8/M12
TPE-U highly flexible - gray E221474	800	M8/M12
PUR irradiated - orange E221474	150	M12
PVC - black E221474	PVC	M8/M12
PVC - gray E221474	500	M8/M12
PVC - yellow E221474	540	M12
PVC 105° - yellow E221474	542	M12

Color coding	Pin assignment
BN	1
BK	4
BU	3

With a combination of M12 and M8 connectors, the limiting M8 value applies to the rated voltage.

Technical data	Technical data	Technical data	Technical data
M8 3-pos.	M8 3-pos., with LEDs	M12 3-pos.	M12 3-pos., with LEDs
Rated voltage [V]	60	250	24
Rated current [A]	4	4	4
Contact material	CuSn	CuSn	CuSn
Contact surface material	Ni/Au	Ni/Au	Ni/Au
Material of grip body	TPU, hardly inflammable, self-extinguishing	TPU, hardly inflammable, self-extinguishing	TPU, hardly inflammable, self-extinguishing
M8 circular connector according to:	IEC 61076-2-104	-	-
M12 circular connector according to:	-	IEC 61076-2-101	IEC 61076-2-101
Degree of protection	IP65 / IP67 / IP68	IP65 / IP67 / IP68	IP65 / IP67 / IP68
Temperature data	-25 ... 90	-25 ... 90	-25 ... 90
Connector/socket	[°C]	[°C]	[°C]

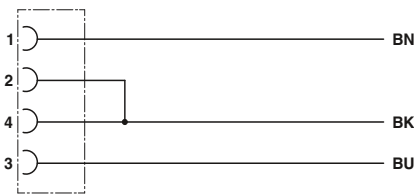

Contact assignment of M12 sockets bridged

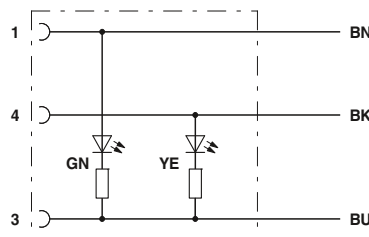

Contact assignment of M8/M12 socket with two LEDs

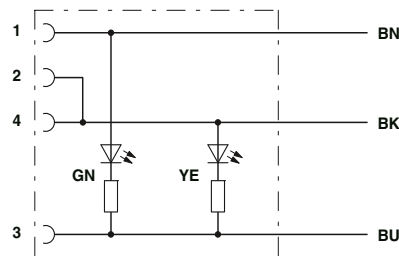

Contact assignment of M12 sockets with 2 LEDs, bridged

Sensor/actuator cabling

Assembled cables

M8 and M12 SAC cable, 3-pos., cable type: PVC

Notes:
For information about the cable qualities, see page 298

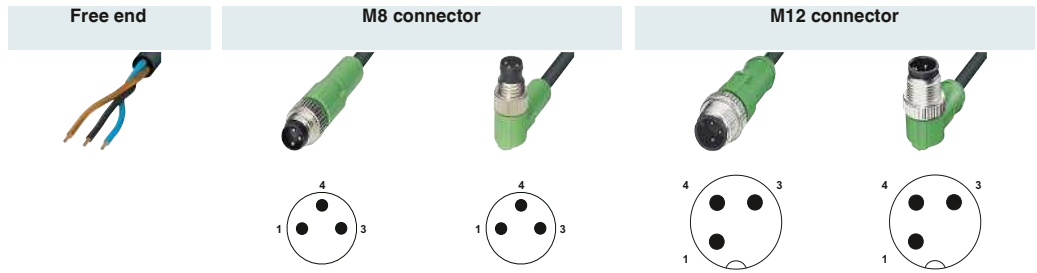

Free end	Ordering data		Ordering data		Ordering data		Ordering data		Ordering data	
	Order No.		Order No.		Order No.		Order No.		Order No.	
			1.5 m	1415861	1.5 m	1415865	1.5 m	1414434	1.5 m	1414447
			3 m	1415862	3 m	1415866	3 m	1414435	3 m	1414448
			5 m	1415863	5 m	1415867	5 m	1693173	5 m	1414449
			10 m	1447280	10 m	1415869	10 m	1414437	10 m	1414450
			Variable	1697548	Variable	1697551	Variable	1696662	Variable	1696675
M8 socket, straight			1.5 m	1415870	0.3 m	1415877	0.3 m	1415881	0.3 m	1415525
			3 m	1415871	0.6 m	1415878	0.6 m	1415882	0.6 m	1415527
			5 m	1510748	1.5 m	1415879	1.5 m	1415883	1.5 m	1415528
			10 m	1506532	3 m	1415880	3 m	1415884	3 m	1415529
			Variable	1697580	Variable	1697632	Variable	1697661	Variable	1696840
M8 socket, angled			1.5 m	1415872	0.3 m	1415886	0.3 m	1415891	0.3 m	1415530
			3 m	1446320	0.6 m	1415888	0.6 m	1415892	0.6 m	1415531
			5 m	1403253	1.5 m	1415889	1.5 m	1415893	1.5 m	1415532
			10 m	1403773	3 m	1415890	3 m	1415894	3 m	1415533
			Variable	1697603	Variable	1697645	Variable	1697674	Variable	1696866
M8 socket, angled, with 2 LEDs			1.5 m	1415874	0.3 m	1415896	0.3 m	1415901		
			3 m	1415875	0.6 m	1415897	0.6 m	1415902		
			5 m	1508174	1.5 m	1415898	1.5 m	1415903		
			10 m	1415876	3 m	1415899	3 m	1415904		
			Variable	1697616	Variable	1697658	Variable	1697687	Variable	1696879
M12 socket, straight			1.5 m	1414451				0.3 m	1414576	
			3 m	1414452				0.6 m	1414577	
			5 m	1400505				1.5 m	1414578	
			10 m	1403486				3 m	1414579	
			Variable	1696688	Variable	1697690	Variable	1697726	Variable	1696756
M12 socket, straight, pin 2 - 4 bridged										
			Variable	1696691				Variable	1696769	Variable
M12 socket, straight, with 2 LEDs			1.5 m	1414556						
			3 m	1414561						
			5 m	1508459						
			10 m	1414565						
			Variable	1696701	Variable	1514197		Variable	1511802	Variable
M12 socket, angled			1.5 m	1414552				0.3 m	1414580	
			3 m	1414553				0.6 m	1414581	
			5 m	1579051				1.5 m	1415519	
			10 m	1453821				3 m	1415520	
			Variable	1696714	Variable	1697700	Variable	1697739	Variable	1696772
M12 socket, angled, pin 2 - 4 bridged										
			Variable	1696727				Variable	1696785	Variable
M12 socket, angled, with 2 LEDs			1.5 m	1414571				0.3 m	1415521	
			3 m	1414573				0.6 m	1415522	
			5 m	1505326				1.5 m	1415523	
			10 m	1414575				3 m	1415524	
			Variable	1696730	Variable	1697713	Variable	1697742	Variable	1696798
M12 socket, angled, with LED, pin 2 - 4 bridged										
			Variable	1696743				Variable	1696808	Variable

Information for products with fixed cable length:

Products with fixed cable length are produced with the PVC cable type and are available from stock.

Ordering data for products with variable cable:

For a sensor/actuator cable, PVC, black, 4.5 m long, with a straight 3-pos. M12 connector and a straight M12 socket, the ordering data is as follows:

Order No.	Cable type	Length [m] Max. 40 m
1696756	PVC	4.5
Minimum order amount = 25		
Increments: 0.2 ... 3 m = 0.1 m > 3 m = 0.5 m		

Cable description	Cable type	Suitable for:
PVC - black E221474	PVC	M8/M12
PVC - gray E221474	500	M8/M12
PVC - yellow E221474	540	M12
PVC 105° - yellow E221474	542	M12
PUR, halogen-free - black E221474	PUR	M8/M12
PUR irradiated - orange E221474	150	M12
PUR, halogen-free - gray E221474	280	M8/M12
TPE-U highly flexible - gray E221474	800	M8/M12

Color coding	Pin assignment
BN	1
BK	4
BU	3

With a combination of M12 and M8 connectors, the limiting M8 value applies to the rated voltage.

Technical data	Technical data	Technical data	Technical data
M8 3-pos.	M8 3-pos., with LEDs	M12 3-pos.	M12 3-pos., with LEDs
Rated voltage [V]	60	250	24
Rated current [A]	4	4	4
Contact material	CuSn	CuSn	CuSn
Contact surface material	Ni/Au	Ni/Au	Ni/Au
Material of grip body	TPU, hardly inflammable, self-extinguishing	TPU, hardly inflammable, self-extinguishing	TPU, hardly inflammable, self-extinguishing
M8 circular connector according to:	IEC 61076-2-104	-	-
M12 circular connector according to:	-	IEC 61076-2-101	IEC 61076-2-101
Degree of protection	IP65 / IP67 / IP68	IP65 / IP67 / IP68	IP65 / IP67 / IP68
Temperature data	-25 ... 90	-25 ... 90	-25 ... 90
Connector/socket	[°C]	[°C]	[°C]

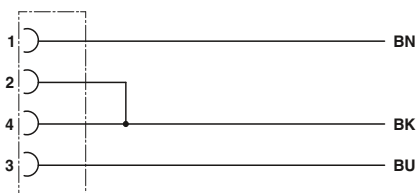

Contact assignment of M12 sockets bridged

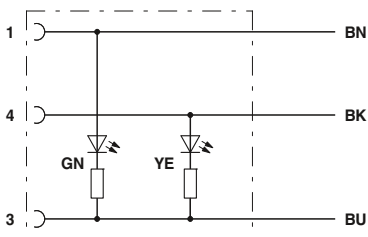

Contact assignment of M8/M12 socket with two LEDs

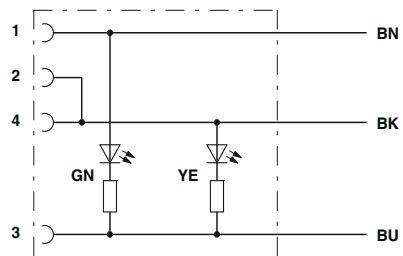

Contact assignment of M12 sockets with 2 LEDs, bridged

Sensor/actuator cabling

Assembled cables

M12 SAC cable, 3-pos., cable type: 800

Notes:
For information about the cable qualities, see page 302

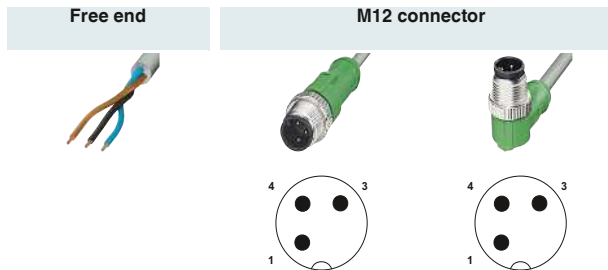

Free end	Ordering data		Ordering data		Ordering data	
	Order No.	Length	Order No.	Length	Order No.	Length
		1.5 m	1456734	1.5 m	1456899	1.5 m
		3 m	1456747	3 m	1456909	3 m
		5 m	1456750	5 m	1456912	5 m
		10 m	1456763	10 m	1456925	10 m
		Variable	1696662	Variable	1696675	Variable
M12 socket, straight 		1.5 m	1456679	0.3 m	1456776	
		3 m	1456682	0.6 m	1456789	
		5 m	1456695	1.5 m	1456792	
		10 m	1456705	3 m	1456802	
		Variable	1696688	Variable	1696756	
M12 socket, angled 		1.5 m	1454260	0.3 m	1456815	
		3 m	1456718	0.6 m	1456828	
		5 m	1454273	1.5 m	1456831	
		10 m	1454299	3 m	1456844	
		Variable	1696714	Variable	1696772	
M12 socket, angled, with 2 LEDs 		1.5 m	1454312	0.3 m	1456857	
		3 m	1456721	0.6 m	1456860	
		5 m	1454325	1.5 m	1456873	
		10 m	1454341	3 m	1456886	
		Variable	1696730	Variable	1696798	

Ordering data for products with variable cables:

For a sensor/actuator cable, TPE-U 800, 4.5 m long, with a straight 3-pos. M12 connector and free cable end, the ordering data is as follows:

Cable description	Cable type	Color coding	Pin assignment
TPE-U highly flexible - gray Robots and drag chains	800	BN BK BU	1 4 3

Order No.	Cable type	Length [m] Max. 40 m
1696662	800	4.5
Minimum order amount = 25		
Increments: 0.2 ... 3 m = 0.1 m > 3 m = 0.5 m		

	Technical data	
	M12 3-pos.	M12 3-pos., with LEDs
Rated voltage [V]	250	24
Rated current [A]	4	4
Contact material	CuSn	CuSn
Contact surface material	Ni/Au	Ni/Au
Material of grip body	TPU, hardly inflammable, self-extinguishing	TPU, hardly inflammable, self-extinguishing
Material, knurls	Zinc die-cast, nickel-plated	Zinc die-cast, nickel-plated
M12 circular connector according to:	IEC 61076-2-101	IEC 61076-2-101
Degree of protection	IP65 / IP67 / IP68	IP65 / IP67 / IP68
Temperature data		
Connector/socket [°C]	-25 ... 90	-25 ... 90

M8 and M12 SAC cable, 3-pos., shielded, cable type: PUR

Notes:
For information about the cable qualities, see page 298

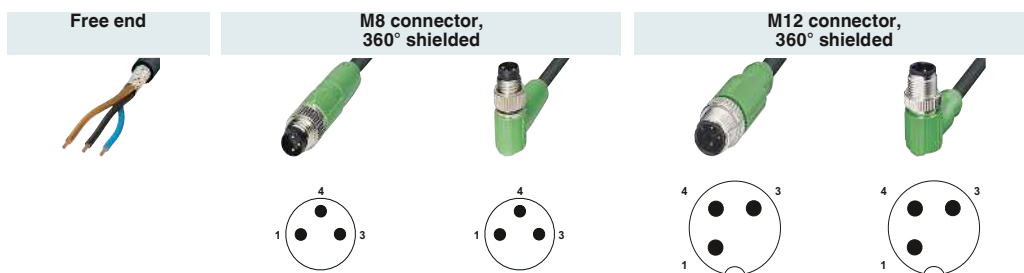

	Ordering data		Ordering data		Ordering data		Ordering data	
Free end	Order No.	Order No.	Order No.	Order No.	Order No.	Order No.	Order No.	
		1.5 m 1521614	1.5 m 1521669	1.5 m 1682650	1.5 m 1682689			
		3 m 1521527	3 m 1521672	3 m 1682663	3 m 1682692			
		5 m 1521630	5 m 1521685	5 m 1682676	5 m 1682702			
		10 m 1521643	10 m 1521698	10 m 1500664	10 m 1500677			
		Variable 1521656	Variable 1521708	Variable 1697425	Variable 1697438			
M8 socket, straight, 360° shielded								
	1.5 m 1521711	0.3 m 1456310						
	3 m 1521724	0.6 m 1456323						
	5 m 1521737	1.5 m 1455285						
	10 m 1521740	3 m 1455298						
	Variable 1521753	Variable 1552052	Variable 1552078					
M8 socket, angled, 360° shielded								
	1.5 m 1521766							
	3 m 1521779							
	5 m 1521782							
	10 m 1521795							
	Variable 1521805	Variable 1552065	Variable 1552081					
M12 socket, straight, 360° shielded								
	1.5 m 1682786			0.3 m 1500800				
	3 m 1682799			0.6 m 1500813				
	5 m 1682809			1.5 m 1500826				
	10 m 1500680			3 m 1500839				
	Variable 1697441			Variable 1536049	Variable 1536065			
M12 socket, angled, 360° shielded								
	1.5 m 1682812			0.3 m 1500923				
	3 m 1682825			0.6 m 1500936				
	5 m 1682838			1.5 m 1500949				
	10 m 1500693			3 m 1500952				
	Variable 1697454			Variable 1536052	Variable 1536078			

Information for products with fixed cable length:

Products with fixed cable length are produced with the halogen-free PUR cable type and are available from stock.

Cable description	Cable type	Suitable for:
PUR, halogen-free - black E221474	PUR	M8/M12
PVC - black E221474	PVC	M12
PVC - gray E221474	500	M12

Color coding	Pin assignment
BN	1
BK	4
BU	3

Ordering data for products with variable cable:

For a shielded sensor/actuator cable, PUR, halogen-free, black, 4.5 m long, with a straight 3-pos. M12 connector and a straight M12 socket, the ordering data is as follows:

Order No.	Cable type	Length [m] Max. 40 m
1536049	PUR	4.5
Minimum order amount = 25		
Increments: 0.2 ... 3 m = 0.1 m > 3 m = 0.5 m		

With a combination of M12 and M8 connectors, the limiting M8 value applies to the rated voltage.

	Technical data	Technical data
	M8 3-pos., shielded	M12 3-pos., shielded
Rated voltage [V]	60	250
Rated current [A]	4	4
Contact material	CuSn	CuSn
Contact surface material	Ni/Au	Ni/Au
Material of grip body	TPU, hardly inflammable, self-extinguishing	TPU, hardly inflammable, self-extinguishing
M8 circular connector according to:	IEC 61076-2-104	-
M12 circular connector according to:	-	IEC 61076-2-101
Degree of protection	IP65 / IP67	IP65 / IP67
Temperature data		
Connector/socket [°C]	-25 ... 90	-25 ... 90

Sensor/actuator cabling

Assembled cables

M8 and M12 SAC cable, 4-pos., cable type: PUR

Notes:
For information about the cable qualities, see page 298

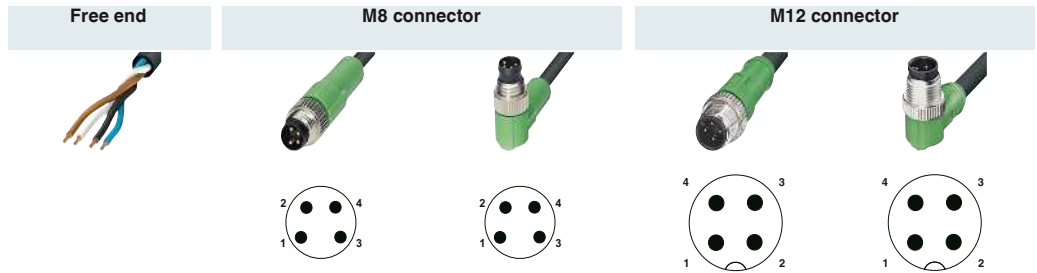

		Ordering data		Ordering data		Ordering data		Ordering data		Ordering data	
Free end		Order No.		Order No.		Order No.		Order No.		Order No.	
				1.5 m	1681787	1.5 m	1681813	1.5 m	1668043	1.5 m	1668166
				3 m	1681790	3 m	1681826	3 m	1668056	3 m	1668179
				5 m	1681800	5 m	1681839	5 m	1668069	5 m	1668182
				10 m	1694143	10 m	1694156	10 m	1682993	10 m	1694457
				Variable	1697755	Variable	1697768	Variable	1696947	Variable	1696950
M8 socket, straight											
		1.5 m	1681842	0.3 m	1682142	0.3 m	1682223	0.3 m	1694923		
		3 m	1681855	0.6 m	1682155	0.6 m	1682236	0.6 m	1693076		
		5 m	1681868	1.5 m	1682168	1.5 m	1682249	1.5 m	1693089		
		10 m	1683484	3 m	1682171	3 m	1682252	3 m	1694936		
		Variable	1697771	Variable	1697797	Variable	1697810	Variable	1697072	Variable	1507874
M8 socket, angled											
		1.5 m	1681871	0.3 m	1682184	0.3 m	1682265			0.3 m	1671551
		3 m	1681884	0.6 m	1682197	0.6 m	1682278			0.6 m	1671564
		5 m	1681897	1.5 m	1682207	1.5 m	1682281			1.5 m	1671577
		10 m	1694172	3 m	1682210	3 m	1682294			3 m	1671580
		Variable	1697784	Variable	1697807	Variable	1697823	Variable	1697085		
M8 socket, angled, with 2 LEDs											
		Variable	1517673					Variable	1515031		
M12 socket, straight											
		1.5 m	1668108					0.3 m	1668357	0.3 m	1668593
		3 m	1668111					0.6 m	1668360	0.6 m	1668603
		5 m	1668124					1.5 m	1668373	1.5 m	1668616
		10 m	1683002					3 m	1668386	3 m	1668629
		Variable	1696963	Variable	1506697			Variable	1697001	Variable	1697030
M12 socket, straight, with 2 LEDs											
		1.5 m	1694800								
		3 m	1694813								
		5 m	1694826								
		10 m	1694839								
		Variable	1696976								
M12 socket, angled											
		1.5 m	1668221					0.3 m	1668470	0.3 m	1668713
		3 m	1668234					0.6 m	1668483	0.6 m	1668726
		5 m	1668247					1.5 m	1668496	1.5 m	1668739
		10 m	1681389					3 m	1668506	3 m	1668742
		Variable	1696989	Variable	1511718	Variable	1697836	Variable	1697014	Variable	1697043
M12 socket, angled, with 3 LEDs											
		1.5 m	1668289					0.3 m	1668519	0.3 m	1668755
		3 m	1668292					0.6 m	1668522	0.6 m	1668768
		5 m	1668302					1.5 m	1668535	1.5 m	1668771
		10 m	1681020					3 m	1668548	3 m	1668784
		Variable	1696992					Variable	1697027	Variable	1697056

Information for products with fixed cable length:

Products with fixed cable length are produced with the halogen-free PUR cable type and are available from stock.

Ordering data for products with variable cable:

For a sensor/actuator cable, PUR, halogen-free, black, 4.5 m long, with a straight 4-pos. M12 connector and a straight M12 socket, the ordering data is as follows:

Order No.	Cable type	Length [m] Max. 40 m
1697001	PUR	4.5
Minimum order amount = 25		
Increments: 0.2 ... 3 m = 0.1 m > 3 m = 0.5 m		

Cable description	Cable type	Suitable for:
PUR, halogen-free - black E221474	PUR	M8/M12
PUR, halogen-free - yellow E221474	240	M12
PUR, halogen-free - gray E221474	280	M8/M12
TPE-U highly flexible - gray E221474	800	M8/M12
PUR irradiated - orange E221474	150	M12
PUR irradiated - yellow E221474	160	M12
PVC - black E221474	PVC	M8/M12
PVC - gray E221474	500	M8/M12
PVC - yellow E221474	540	M12
PVC 105° - yellow E221474	542	M12

Color coding	Pin assignment
BN	1
WH	2
BK	4
BU	3

With a combination of M12 and M8 connectors, the limiting M8 value applies to the rated voltage.

	Technical data	Technical data	Technical data	Technical data
	M8 4-pos.	M8 4-pos., with LED	M12 4-pos.	M12 4-pos., with LED
Rated voltage [V]	30	24	250	24
Rated current [A]	4	4	4	4
Contact material	CuSn	CuSn	CuSn	CuSn
Contact surface material	Ni/Au	Ni/Au	Ni/Au	Ni/Au
Material of grip body	TPU, hardly inflammable, self-extinguishing	TPU, hardly inflammable, self-extinguishing	TPU, hardly inflammable, self-extinguishing	TPU, hardly inflammable, self-extinguishing
M8 circular connector according to:	IEC 61076-2-104	IEC 61076-2-104	-	-
M12 circular connector according to:	-	-	IEC 61076-2-101	IEC 61076-2-101
Degree of protection	IP65 / IP67 / IP68	IP65 / IP67 / IP68	IP65 / IP67 / IP68	IP65 / IP67 / IP68
Temperature data				
Connector/socket [°C]	-25 ... 90	-25 ... 90	-25 ... 90	-25 ... 90

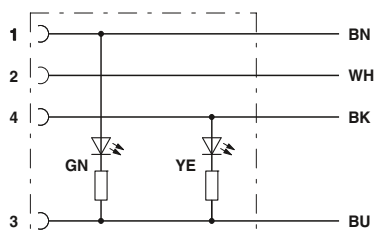

Contact assignment of M8/M12 socket with LED

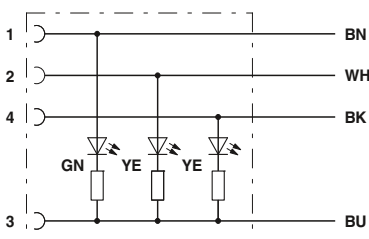

Contact assignment of M12 sockets with LED

Sensor/actuator cabling

Assembled cables

M8 and M12 SAC cable, 4-pos., cable type: PVC

Notes:
For information about the cable qualities, see page 298

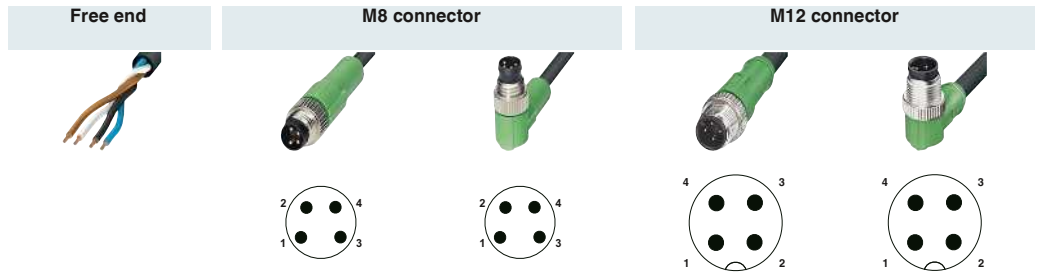

Free end	Ordering data		Ordering data		Ordering data		Ordering data		Ordering data			
	Order No.		Order No.		Order No.		Order No.		Order No.			
			1.5 m	1415542	1.5 m	1415546	1.5 m	1415585	1.5 m	1415591		
			3 m	1415543	3 m	1415547	3 m	1415588	3 m	1415592		
			5 m	1415544	5 m	1415548	5 m	1415589	5 m	1415593		
			10 m	1415545	10 m	1415549	10 m	1415590	10 m	1415594		
			Variable	1697755	Variable	1697768	Variable	1696947	Variable	1696950		
M8 socket, straight			1.5 m	1415550	0.3 m	1415556	0.3 m	1415576	0.3 m	1415671		
			3 m	1415551	0.6 m	1415557	0.6 m	1415577	0.6 m	1415672		
			5 m	1403252	1.5 m	1415558	1.5 m	1415578	1.5 m	1415673		
			10 m	1401062	3 m	1415560	3 m	1415579	3 m	1415674		
			Variable	1697771	Variable	1697797	Variable	1697810	Variable	1697072		
									Variable	1507874		
M8 socket, angled			1.5 m	1415552	0.3 m	1415562	0.3 m	1415580	0.3 m	1415667		
			3 m	1415554	0.6 m	1415572	0.6 m	1415581	0.6 m	1415668		
			5 m	1403254	1.5 m	1415573	1.5 m	1415582	1.5 m	1415669		
			10 m	1401064	3 m	1415574	3 m	1415583	3 m	1415670		
			Variable	1697784	Variable	1697807	Variable	1697823	Variable	1697085		
M8 socket, angled, with 2 LEDs			Variable	1517673					Variable	1515031		
M12 socket, straight			1.5 m	1544976				0.3 m	1415611	0.3 m	1415627	
			3 m	1404407				0.6 m	1415612	0.6 m	1415628	
			5 m	1404408				1.5 m	1415613	1.5 m	1415635	
			10 m	1446333				3 m	1415614	3 m	1415636	
			Variable	1696963	Variable	1506697		Variable	1697001	Variable	1697030	
M12 socket, straight, with 2 LEDs			1.5 m	1415596								
			3 m	1415597								
			5 m	1415602								
			10 m	1415605								
			Variable	1696976								
M12 socket, angled			1.5 m	1415606				0.3 m	1415617	0.3 m	1415642	
			3 m	1693526				0.6 m	1454817	0.6 m	1415643	
			5 m	1693539				1.5 m	1415618	1.5 m	1415644	
			10 m	1415608				3 m	1415619	3 m	1415645	
			Variable	1696989	Variable	1511718	Variable	1697836	Variable	1697014	Variable	1697043
M12 socket, angled, with 3 LEDs			1.5 m	1415609				0.3 m	1415620	0.3 m	1415646	
			3 m	1415610				0.6 m	1415623	0.6 m	1415647	
			5 m	1404961				1.5 m	1415624	1.5 m	1415648	
			10 m	1401063				3 m	1415625	3 m	1415650	
			Variable	1696992				Variable	1697027	Variable	1697056	

Information for products with fixed cable length:

Products with fixed cable length are produced with the **PVC** cable type and are available from stock.

Ordering data for products with variable cable:

For a sensor/actuator cable, PVC, black, 4.5 m long, with a straight 4-pos. M12 connector and a straight M12 socket, the ordering data is as follows:

Order No.	Cable type	Length [m] Max. 40 m
1697001	PVC	4.5
Minimum order amount = 25		
Increments: 0.2 ... 3 m = 0.1 m > 3 m = 0.5 m		

Cable description	Cable type	Suitable for:	Color coding	Pin assignment
PVC - black E221474	PVC	M8/M12	BN	1
PVC - gray E221474	500	M8/M12	WH	2
PVC - yellow E221474	540	M12	BK	4
PVC 105° - yellow E221474	542	M12	BU	3
PUR, halogen-free - black E221474	PUR	M8/M12		
PUR, halogen-free - yellow E221474	240	M12		
PUR, halogen-free - gray E221474	280	M8/M12		
PUR irradiated - orange E221474	150	M12		
PUR irradiated - yellow E221474	160	M12		
TPE-U highly flexible - gray E221474	800	M8/M12		

With a combination of M12 and M8 connectors, the limiting M8 value applies to the rated voltage.

	Technical data	Technical data	Technical data	Technical data
	M8 4-pos.	M8 4-pos., with LED	M12 4-pos.	M12 4-pos., with LED
Rated voltage [V]	30	24	250	24
Rated current [A]	4	4	4	4
Contact material	CuSn	CuSn	CuSn	CuSn
Contact surface material	Ni/Au	Ni/Au	Ni/Au	Ni/Au
Material of grip body	TPU, hardly inflammable, self-extinguishing	TPU, hardly inflammable, self-extinguishing	TPU, hardly inflammable, self-extinguishing	TPU, hardly inflammable, self-extinguishing
M8 circular connector according to:	IEC 61076-2-104	IEC 61076-2-104	-	-
M12 circular connector according to:	-	-	IEC 61076-2-101	IEC 61076-2-101
Degree of protection	IP65 / IP67 / IP68	IP65 / IP67 / IP68	IP65 / IP67 / IP68	IP65 / IP67 / IP68
Temperature data				
Connector/socket [°C]	-25 ... 90	-25 ... 90	-25 ... 90	-25 ... 90

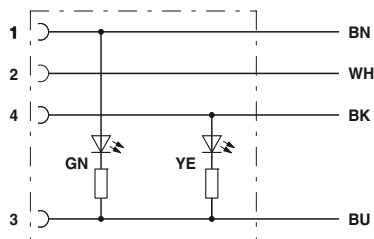

Contact assignment of M8/M12 socket with LED

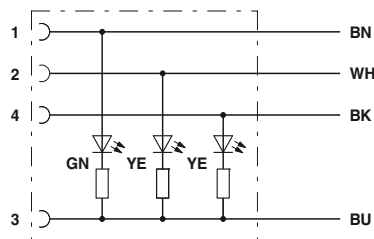

Contact assignment of M12 sockets with LED

Sensor/actuator cabling

Assembled cables

M12 SAC cable, 4-pos., cable type: 800

Notes:
For information about the cable qualities, see page 302

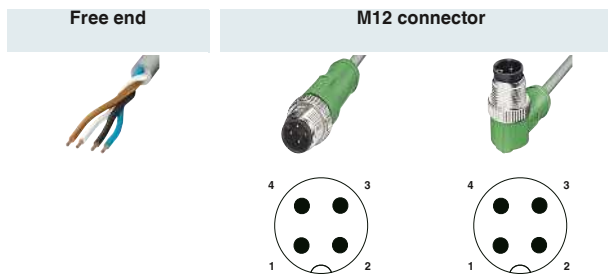

Free end	Ordering data		Ordering data		Ordering data	
	Order No.	Length	Order No.	Length	Order No.	Length
		1.5 m	1457018	1.5 m	1457128	1.5 m
		3 m	1457021	3 m	1457131	3 m
		5 m	1457034	5 m	1457144	5 m
		10 m	1457047	10 m	1457157	10 m
		Variable	1696947	Variable	1696950	Variable
M12 socket, straight 		1.5 m	1456938	0.3 m	1457050	0.3 m
		3 m	1456941	0.6 m	1457063	0.6 m
		5 m	1567322	1.5 m	1567270	1.5 m
		10 m	1567335	3 m	1457076	3 m
		Variable	1696963	Variable	1697001	Variable
M12 socket, angled 		1.5 m	1456954	0.3 m	1457089	0.3 m
		3 m	1456967	0.6 m	1567225	0.6 m
		5 m	1456970	1.5 m	1567238	1.5 m
		10 m	1456983	3 m	1457092	3 m
		Variable	1696989	Variable	1697014	Variable
M12 socket, angled, with 3 LEDs 		1.5 m	1456996	0.3 m	1457102	0.3 m
		3 m	1457005	0.6 m	1567173	0.6 m
		5 m	1567351	1.5 m	1567199	1.5 m
		10 m	1567364	3 m	1457115	3 m
		Variable	1696992	Variable	1697027	Variable

Ordering data for products with variable cables:

For a sensor/actuator cable, TPE-U 800, 4.5 m long, with a straight 4-pos. M12 connector and free cable end, the ordering data is as follows:

Cable description	Cable type	Color coding	Pin assignment
TPE-U highly flexible - gray Robots and drag chains	800	BN WH BK BU	1 2 4 3

Order No.	Cable type	Length [m] Max. 40 m
1696947	800	4.5
Minimum order amount = 25		
Increments: 0.2 ... 3 m = 0.1 m > 3 m = 0.5 m		

	Technical data	
	M12 4-pos.	M12 4-pos., with LED
Rated voltage [V]	250	24
Rated current [A]	4	4
Contact material	CuSn	CuSn
Contact surface material	Ni/Au	Ni/Au
Material of grip body	TPU, hardly inflammable, self-extinguishing	TPU, hardly inflammable, self-extinguishing
Material, knurls	Zinc die-cast, nickel-plated	Zinc die-cast, nickel-plated
M12 circular connector according to:	IEC 61076-2-101	IEC 61076-2-101
Degree of protection	IP65 / IP67 / IP68	IP65 / IP67 / IP68
Temperature data		
Connector/socket [°C]	-25 ... 90	-25 ... 90

M8 and M12 SAC cable, 4-pos., shielded, cable type: PUR

Notes:
For information about the cable qualities, see page 298

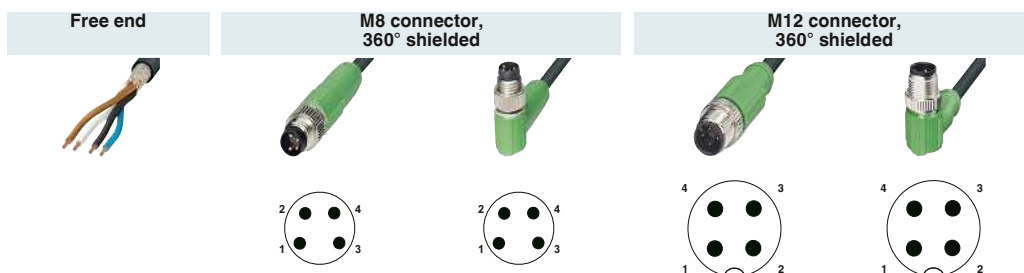

	Ordering data		Ordering data		Ordering data		Ordering data		Ordering data	
Free end	Order No.	Order No.	Order No.	Order No.	Order No.	Order No.	Order No.	Order No.	Order No.	Order No.
		1.5 m 3 m 5 m 10 m Variable	1521818 1521821 1521834 1521847 1521850	1.5 m 3 m 5 m 10 m Variable	1521863 1521876 1521889 1521892 1521902	1.5 m 3 m 5 m 10 m Variable	1682715 1682618 1682647 1694389 1697467	1.5 m 3 m 5 m 10 m Variable	1682870 1682883 1682896 1500703 1697470	
M8 socket, straight, 360° shielded		1.5 m 3 m 5 m 10 m Variable	1521915 1521928 1521931 1521944 1521957	0.3 m 0.6 m 1.5 m 3 m Variable	1574580 1455722 1455735 1574603 1552094					
M8 socket, angled, 360° shielded		1.5 m 3 m 5 m 10 m Variable	1521960 1521973 1521986 1521999 1522008							Variable 1552104
M12 socket, straight, 360° shielded		1.5 m 3 m 5 m 10 m Variable	1682841 1682854 1682867 1500716 1697483			0.3 m 0.6 m 1.5 m 3 m Variable	1500842 1500855 1500868 1500871 1536081			Variable 1536104
M12 socket, angled, 360° shielded		1.5 m 3 m 5 m 10 m Variable	1682906 1682919 1682922 1500729 1697496			0.3 m 0.6 m 1.5 m 3 m Variable	1500965 1500978 1500981 1500994 1536094			Variable 1536117

Information for products with fixed cable length:

Products with fixed cable length are produced with the halogen-free PUR cable type and are available from stock.

Cable description	Cable type	Suitable for:	Color coding	Pin assignment
PUR, halogen-free - black E221474	PUR	M8/M12	BN	1
PVC - black E221474	PVC	M12	WH	2
PVC - gray E221474	500	M12	BK	4
			BU	3

Ordering data for products with variable cable:

For a shielded sensor/actuator cable, PUR, halogen-free, black, 4.5 m long, with a straight 4-pos. M12 connector and a straight M12 socket, the ordering data is as follows:

Order No.	Cable type	Length [m] Max. 40 m
1536081	PUR	4.5
Minimum order amount = 25		Increments: 0.2 ... 3 m = 0.1 m > 3 m = 0.5 m

With a combination of M12 and M8 connectors, the limiting M8 value applies to the rated voltage.

	Technical data	Technical data
	M8 4-pos., shielded	M12 4-pos., shielded
Rated voltage	30 [V]	250
Rated current	4 [A]	4
Contact material	CuSn	CuSn
Contact surface material	Ni/Au	Ni/Au
Material of grip body	TPU, hardly inflammable, self-extinguishing	TPU, hardly inflammable, self-extinguishing
M8 circular connector according to:	IEC 61076-2-104	-
M12 circular connector according to:	-	IEC 61076-2-101
Degree of protection	IP65 / IP67	IP65 / IP67
Temperature data		
Connector/socket	-25 ... 90 [°C]	-25 ... 90

Sensor/actuator cabling

Assembled cables

M8 SAC cable, 5-pos., B-coded, cable type: PUR

Notes:

For information about the cable qualities, see page 298

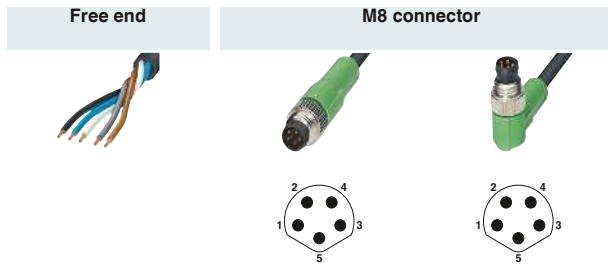

	Ordering data	Ordering data	Ordering data
Free end	Order No.	Order No.	Order No.
	1.5 m	1404461	1.5 m 1404465
	3 m	1404462	3 m 1404466
	5 m	1404463	5 m 1404467
	10 m	1404464	10 m 1404468
M8 socket, straight 	1.5 m	1404470	0.3 m 1404479
	3 m	1404471	0.6 m 1404480
	5 m	1404473	1.5 m 1404481
	10 m	1404474	3 m 1404482
M8 socket, angled 	1.5 m	1404475	
	3 m	1404476	
	5 m	1404477	
	10 m	1404478	

Cable description	Cable type	Color coding	Pin assignment
PUR, halogen free - black	115	BN WH BK BU GY	1 2 4 3 5

		Technical data
		M85-pos.
Rated voltage	[V]	30
Rated current	[A]	3
Contact material		CuSn
Contact surface material		Ni/Au
Material of grip body		TPU, hardly inflammable, self-extinguishing
Material, knurls		Zinc die-cast, nickel-plated
M8 circular connector according to:		IEC 61076-2-104
Degree of protection		IP65 / IP67 / IP68
Temperature data		
Connector/socket	[°C]	-25 ... 90

M12 SAC cable, 5-pos., cable type: PUR

Notes:
For information about the cable qualities, see page 298

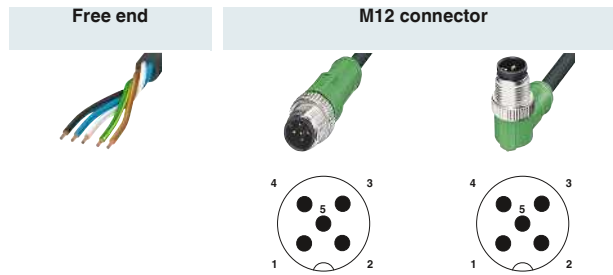

Free end	Ordering data	Ordering data	Ordering data
	Order No.	Order No.	Order No.
	1.5 m	1669767	1.5 m 1669796
	3 m	1669770	3 m 1669806
	5 m	1669783	5 m 1669819
	10 m	1683361	10 m 1694460
	Variable	1697098	Variable 1697108
M12 socket, straight 	1.5 m	1669822	0.3 m 1681583
	3 m	1669835	0.6 m 1681596
	5 m	1669848	1.5 m 1681606
	10 m	1683374	3 m 1681619
	Variable	1697111	Variable 1697140
M12 socket, angled 	1.5 m	1669851	0.3 m 1681622
	3 m	1669864	0.6 m 1681635
	5 m	1669877	1.5 m 1681648
	10 m	1694541	3 m 1681651
	Variable	1697124	Variable 1697153
M12 socket, angled, with 3 LEDs 	1.5 m	1669880	0.3 m 1694635
	3 m	1669893	0.6 m 1694648
	5 m	1669903	1.5 m 1694651
	10 m	1694431	
	Variable	1697137	Variable 1697166

Information for products with fixed cable length:

Products with fixed cable length are produced with the halogen-free PUR cable type and are available from stock.

Ordering data for products with variable cable:

For a sensor/actuator cable, PUR, halogen-free, black, 4.5 m long, with a straight 5-pos. M12 connector and a straight M12 socket, the ordering data is as follows:

Order No.	Cable type	Length [m] Max. 40 m
1697140	PUR	4.5
Minimum order amount = 25		
Increments: 0.2 ... 3 m = 0.1 m > 3 m = 0.5 m		

Cable description	Cable type	Color coding	Pin assignment
PUR, halogen-free - black E221474	PUR	BN	1
PUR, halogen-free - black, 5th wire gray E221474	115	WH	2
TPE-U highly flexible - gray, 5th wire gray E221474	800	BK	4
PUR irradiated - orange E221474	150	BU	3
PVC - black E221474	PVC	GNYE	5
PVC - black, 5th wire gray E221474	515		
PVC - gray E221474	500		
PVC 105° - yellow E221474	540		
PVC 105° - yellow, 5th wire gray E221474	542		

	Technical data	Technical data
	M12 5-pos.	M12 5-pos., with LED
Rated voltage [V]	60	24
Rated current [A]	4	4
Contact material	CuSn	CuSn
Contact surface material	Ni/Au	Ni/Au
Material of grip body	TPU, hardly inflammable, self-extinguishing	TPU, hardly inflammable, self-extinguishing
M12 circular connector according to:	IEC 61076-2-101	IEC 61076-2-101
Degree of protection	IP65 / IP67 / IP68	IP65 / IP67 / IP68
Temperature data		
Connector/socket [°C]	-25 ... 90	-25 ... 90

Sensor/actuator cabling

Assembled cables

M12 SAC cable, 5-pos., cable type: PVC

Notes:
For information about the cable qualities, see page 298

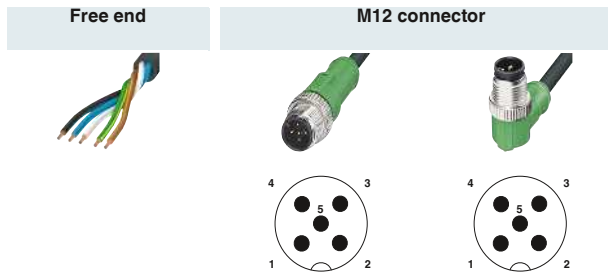

Free end	Ordering data		Ordering data		Ordering data	
	Order No.		Order No.		Order No.	
		1.5 m	1415675	1.5 m	1415679	
		3 m	1415676	3 m	1415680	
		5 m	1415677	5 m	1415681	
		10 m	1415678	10 m	1415682	
		Variable	1697098	Variable	1697108	
M12 socket, straight 		1.5 m	1415683	0.3 m	1415695	
		3 m	1415684	0.6 m	1415696	
		5 m	1453889	1.5 m	1415697	
		10 m	1415685	3 m	1415698	
		Variable	1697111	Variable	1697140	Variable
M12 socket, angled 		1.5 m	1415686	0.3 m	1415699	
		3 m	1415687	0.6 m	1415700	
		5 m	1415688	1.5 m	1415701	
		10 m	1415689	3 m	1415702	
		Variable	1697124	Variable	1697153	Variable
M12 socket, angled, with 3 LEDs 		1.5 m	1415690	0.3 m	1415703	
		3 m	1415691	0.6 m	1415704	
		5 m	1415693	1.5 m	1415705	
		10 m	1415694	3 m	1415706	
		Variable	1697137	Variable	1697166	Variable

Information for products with fixed cable length:

Products with fixed cable length are produced with the PVC cable type and are available from stock.

Ordering data for products with variable cable:

For a sensor/actuator cable, PVC, black, 4.5 m long, with a straight 5-pos. M12 connector and a straight M12 socket, the ordering data is as follows:

Order No.	Cable type	Length [m] Max. 40 m
1697140	PVC	4.5
Minimum order amount = 25		
Increments: 0.2 ... 3 m = 0.1 m > 3 m = 0.5 m		

Cable description	Cable type	Color coding	Pin assignment
PVC - black E221474	PVC	BN	1
PVC - black, 5th wire gray E221474	515	WH	2
PVC - gray E221474	500	BK	4
PVC 105° - yellow E221474	540	BU	3
PVC 105° - yellow, 5th wire gray E221474	542	GNYE	5
PUR, halogen-free - black E221474	PUR		
PUR, halogen-free - black, 5th wire gray E221474	115		
PUR irradiated - orange E221474	150		
TPE-U highly flexible - gray, 5th wire gray E221474	800		

	Technical data	Technical data
	M12 5-pos.	M12 5-pos., with LED
Rated voltage [V]	60	24
Rated current [A]	4	4
Contact material	CuSn	CuSn
Contact surface material	Ni/Au	Ni/Au
Material of grip body	TPU, hardly inflammable, self-extinguishing	TPU, hardly inflammable, self-extinguishing
M12 circular connector according to:		
Degree of protection	IP65 / IP67 / IP68	IEC 61076-2-101
Temperature data		IP65 / IP67 / IP68
Connector/socket [°C]	-25 ... 90	-25 ... 90

M12 SAC cable, 5-pos., cable type: 802

Notes:
For information about the cable qualities, see page 302

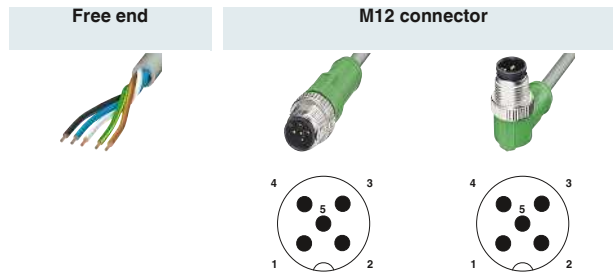

Free end	Ordering data		Ordering data		Ordering data	
	Order No.	Order No.	Order No.	Order No.	Order No.	Order No.
	1.5 m	1457225	1.5 m	1457322		
	3 m	1457238	3 m	1457335		
	5 m	1457241	5 m	1457348		
	10 m	1457254	10 m	1457351		
	Variable	1697098	Variable	1697108		
M12 socket, straight 	1.5 m	1454419	0.3 m	1457267		
	3 m	1457160	0.6 m	1454561		
	5 m	1454422	1.5 m	1454587		
	10 m	1454448	3 m	1457270		
	Variable	1697111	Variable	1697140		
M12 socket, angled 	1.5 m	1457173	0.3 m	1457283		
	3 m	1457186	0.6 m	1454516		
	5 m	1457199	1.5 m	1454532		
	10 m	1457209	3 m	1457296		
	Variable	1697124	Variable	1697153		
M12 socket, angled, with 3 LEDs 	1.5 m	1454367	0.3 m	1457306		
	3 m	1457212	0.6 m	1454464		
	5 m	1454370	1.5 m	1454480		
	10 m	1454396	3 m	1457319		
	Variable	1697137	Variable	1697166		

Ordering data for products with variable cables:

For a sensor/actuator cable, TPE-U 802, 4.5 m long, with a straight 5-pos. M12 connector and free cable end, the ordering data is as follows:

Cable description	Cable type	Color coding	Pin assignment
TPE-U highly flexible - gray Robots and drag chains	802	BN WH BK BU GNYE	1 2 4 3 5

Order No.	Cable type	Length [m] Max. 40 m
1697098	802	4.5
Minimum order amount = 25		
Increments: 0.2 ... 3 m = 0.1 m > 3 m = 0.5 m		

	Technical data	
	M12 5-pos.	M12 5-pos., with LED
Rated voltage [V]	60	24
Rated current [A]	4	4
Contact material	CuSn	CuSn
Contact surface material	Ni/Au	Ni/Au
Material of grip body	TPU, hardly inflammable, self-extinguishing	TPU, hardly inflammable, self-extinguishing
Material, knurls	Zinc die-cast, nickel-plated	Zinc die-cast, nickel-plated
M12 circular connector according to:	IEC 61076-2-101	IEC 61076-2-101
Degree of protection	IP65 / IP67 / IP68	IP65 / IP67 / IP68
Temperature data		
Connector/socket [°C]	-25 ... 90	-25 ... 90

Sensor/actuator cabling

Assembled cables

M12 SAC cable, 5-pos., shielded, cable type: PUR

Notes:

For information about the cable qualities, see page 298

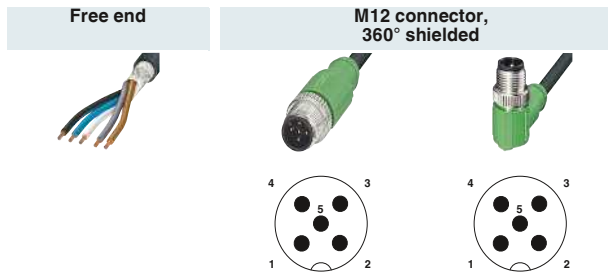

	Ordering data	Ordering data	Ordering data
Free end	Order No.	Order No.	Order No.
	1.5 m	1682728	1.5 m 1682757
	3 m	1682744	3 m 1682760
	5 m	1682731	5 m 1682773
	10 m	1500732	10 m 1500745
	Variable	1697506	Variable 1697519
M12 socket, straight, 360° shielded 	1.5 m	1682935	0.3 m 1500884
	3 m	1682948	0.6 m 1500897
	5 m	1682951	1.5 m 1500907
	10 m	1500758	3 m 1500910
	Variable	1697522	Variable 1536120
M12 socket, angled, 360° shielded 	1.5 m	1682964	0.3 m 1501003
	3 m	1682977	0.6 m 1501029
	5 m	1682980	1.5 m 1501045
	10 m	1500761	3 m 1501058
	Variable	1697535	Variable 1536133

Information for products with fixed cable length:

Products with fixed cable length are produced with the halogen-free PUR cable type and are available from stock.

Cable description	Cable type	Color coding	Pin assignment
PUR, halogen-free - black E221474	PUR	BN	1
PVC - black E221474	PVC	WH	2
PVC - gray E221474	500	BK	4
		BU	3
		GY	5

Ordering data for products with variable cable:

For a shielded sensor/actuator cable, PUR, halogen-free, black, 4.5 m long, with a straight 5-pos. M12 connector and a straight M12 socket, the ordering data is as follows:

Order No.	Cable type	Length [m] Max. 40 m
1536120	PUR	4.5
Minimum order amount = 25		Increments: 0.2 ... 3 m = 0.1 m > 3 m = 0.5 m

Technical data	
M12	
5-pos., shielded	
Rated voltage [V]	60
Rated current [A]	4
Contact material	CuSn
Contact surface material	Ni/Au
Material of grip body	TPU, hardly inflammable, self-extinguishing
M12 circular connector according to:	IEC 61076-2-101
Degree of protection	IP65 / IP67
Temperature data	
Connector/socket [°C]	-25 ... 90

**M8 SAC cable,
6-pos.,
cable type: PUR**

Notes:
For information about the cable qualities, see page 298

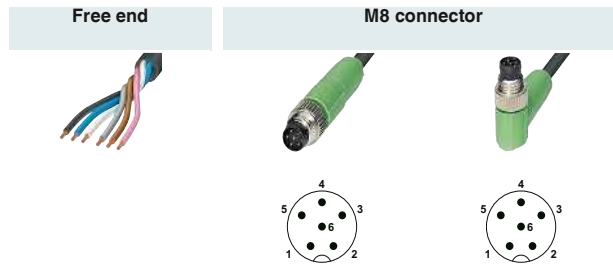

	Ordering data	Ordering data	Ordering data
Free end	Order No.	Order No.	Order No.
	1.5 m	1.5 m	1.5 m
	3 m	3 m	3 m
	5 m	5 m	5 m
	10 m	10 m	10 m
	Variable	Variable	Variable
M8 socket, straight	Order No.	Order No.	Order No.
	1.5 m	1.5 m	1.5 m
	3 m	3 m	3 m
	5 m	5 m	5 m
	10 m	10 m	10 m
	Variable	Variable	Variable
M8 socket, angled	Order No.	Order No.	Order No.
	1.5 m	1.5 m	1.5 m
	3 m	3 m	3 m
	5 m	5 m	5 m
	10 m	10 m	10 m
	Variable	Variable	Variable

Information for products with fixed cable length:

Products with fixed cable length are produced with the halogen-free PUR cable type and are available from stock.

Cable description	Cable type	Color coding	Pin assignment
PUR, halogen-free - black E221474	PUR	BN WH BU BK GY PK	1 2 3 4 5 6

Ordering data for products with variable cable:

For a shielded sensor/actuator cable, PUR, halogen-free, black, 4.5 m long, with a straight 6-pos. M8 connector and open cable end, the ordering data is as follows:

Order No.	Cable type	Length [m] Max. 40 m
1522134	PUR	4.5
Minimum order amount = 25		
Increments: 0.2 ... 3 m = 0.1 m > 3 m = 0.5 m		

Technical data	
M8 6-pos.	
Rated voltage	[V] 30
Rated current	[A] 1.5
Contact material	CuZn
Contact surface material	Ni/Au
Material of grip body	TPU, hardly inflammable, self-extinguishing
M8 circular connector according to:	IEC 61076-2-104
Degree of protection	IP65 / IP67 / IP68
Temperature data	
Connector/socket	[°C] -25 ... 90

Sensor/actuator cabling

Assembled cables

M8 SAC cable, 6-pos., shielded, cable type: PUR

Notes:

For information about the cable qualities, see page 298

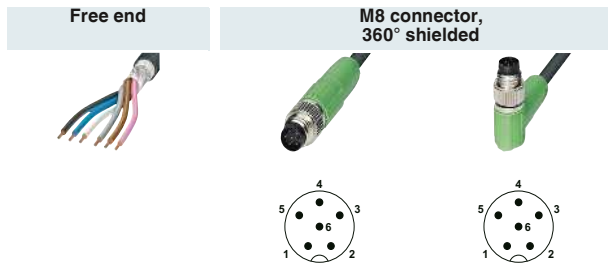

	Ordering data	Ordering data	Ordering data
Free end	Order No.	Order No.	Order No.
	1.5 m	1522299	1.5 m 1522341
	3 m	1522309	3 m 1522354
	5 m	1522312	5 m 1522367
	10 m	1522325	5 m 1522370
	Variable	1522338	Variable 1522383
M8 socket, straight, 360° shielded 	1.5 m	1522396	
	3 m	1522406	
	5 m	1522419	
	10 m	1522422	
	Variable	1522435	Variable 1552010 Variable 1552036
M8 socket, angled, 360° shielded 	1.5 m	1522448	
	3 m	1522451	
	5 m	1522464	
	10 m	1522477	
	Variable	1522480	Variable 1552023 Variable 1552049

Information for products with fixed cable length:

Products with fixed cable length are produced with the halogen-free PUR cable type and are available from stock.

Cable description	Cable type	Color coding	Pin assignment																		
PUR, halogen-free - black E221474	PUR	<table border="1"> <tr><td>BN</td><td></td><td>1</td></tr> <tr><td>WH</td><td></td><td>2</td></tr> <tr><td>BU</td><td></td><td>3</td></tr> <tr><td>BK</td><td></td><td>4</td></tr> <tr><td>GY</td><td></td><td>5</td></tr> <tr><td>PK</td><td></td><td>6</td></tr> </table>	BN		1	WH		2	BU		3	BK		4	GY		5	PK		6	
BN		1																			
WH		2																			
BU		3																			
BK		4																			
GY		5																			
PK		6																			

Ordering data for products with variable cable:

For a shielded sensor/actuator cable, PUR, halogen-free, black, 4.5 m long, with a straight 6-pos. M8 connector and a straight M8 socket, the ordering data is as follows:

Order No.	Cable type	Length [m] Max. 40 m
1552010	PUR	4.5
Minimum order amount = 25		Increments: 0.2 ... 3 m = 0.1 m > 3 m = 0.5 m

Technical data	
M8 6-pos., shielded	
Rated voltage [V]	30
Rated current [A]	1.5
Contact material	CuZn
Contact surface material	Ni/Au
Material of grip body	TPU, hardly inflammable, self-extinguishing
M8 circular connector according to:	IEC 61076-2-104
Degree of protection	IP65 / IP67
Temperature data	
Connector/socket [°C]	-25 ... 90

**M8 SAC cable,
8-pos.,
cable type: PUR**

Notes:
For information about the cable qualities, see page 298

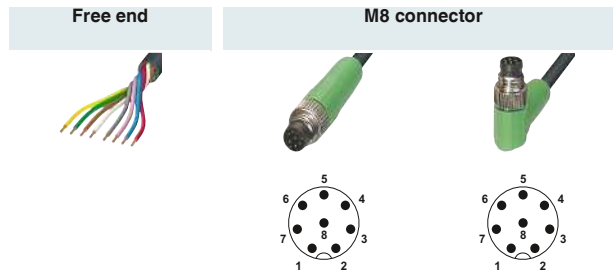

Ordering data **Ordering data** **Ordering data**

Free end	Order No.	Order No.	Order No.
	1.5 m	1404178	1.5 m 1404182
	3 m	1404180	3 m 1404186
	5 m	1404181	5 m 1404185
	10 m	1404179	10 m 1404183

M8 socket, straight	Order No.	Order No.
	1.5 m 1404187	0.3 m 1404196
	3 m 1404188	0.6 m 1404198
	5 m 1404189	1.5 m 1404199
	10 m 1404190	3 m 1404200

M8 socket, angled	Order No.	Order No.
	1.5 m 1404191	0.3 m 1404201
	3 m 1404192	0.6 m 1404202
	5 m 1404193	1.5 m 1404203
	10 m 1404194	3 m 1404204

Cable description	Cable type	Color coding	Pin assignment
PUR, halogen free - black	PUR	WH	1
		BN	2
		GN	3
		YE	4
		GY	5
		PK	6
		BU	7
		RD	8

		Technical data
		M8 8-pos.
Rated voltage	[V]	30
Rated current	[A]	1.5
Contact material		CuSn
Contact surface material		Ni/Au
Material of grip body		TPU, hardly inflammable, self-extinguishing
Material, knurls		Zinc die-cast, nickel-plated
M8 circular connector according to:		IEC 61076-2-104
Degree of protection		IP65 / IP67 / IP68
Temperature data		
Connector/socket	[°C]	-25 ... 85

Sensor/actuator cabling

Assembled cables

M12 SAC cable, 8-pos., cable type: PUR

Notes:

For information about the cable qualities, see page 298

Free end



M12 connector



	Ordering data	Ordering data	Ordering data
Free end	Order No.	Order No.	Order No.
	1.5 m	1522493	1.5 m 1522545
	3 m	1522503	3 m 1522558
	5 m	1522516	5 m 1522561
	10 m	1522529	10 m 1522574
	Variable	1522532	Variable 1522587
M12 socket, straight 	1.5 m	1522590	0.3 m 1522671
	3 m	1522600	0.6 m 1522684
	5 m	1520369	1.5 m 1522697
	10 m	1520372	3 m 1522707
	Variable	1522613	Variable 1522710
M12 socket, angled 	1.5 m	1522626	0.3 m 1522723
	3 m	1522639	0.6 m 1522736
	5 m	1522642	1.5 m 1522749
	10 m	1522655	3 m 1522752
	Variable	1522668	Variable 1522765

Information for products with fixed cable length:

Products with fixed cable length are produced with the halogen-free PUR cable type and are available from stock.

Ordering data for products with variable cable:

For a sensor/actuator cable, PUR, halogen-free, black, 4.5 m long, with a straight 8-pos. M12 connector and a straight M12 socket, the ordering data is as follows:

Order No.	Cable type	Length [m] Max. 40 m
1522710	PUR	4.5
Minimum order amount = 25		Increments: 0.2 ... 3 m = 0.1 m > 3 m = 0.5 m

Cable description	Cable type	Color coding	Pin assignment
PUR, halogen-free - black E221474	PUR	WH	1
TPE-U highly flexible - gray E221474	800	BN	2
		GN	3
PVC - black E221474	PVC	YE	4
		GY	5
PVC - gray E221474	500	PK	6
		BU	7
		RD	8

Technical data

		M12 8-pos.
Rated voltage	[V]	30
Rated current	[A]	2
Contact material		CuZn
Contact surface material		Ni/Au
Material of grip body		TPU, hardly inflammable, self-extinguishing
M12 circular connector according to:		IEC 61076-2-101
Degree of protection		IP65 / IP67 / IP68
Temperature data		
Connector/socket	[°C]	-25 ... 90

M12 SAC cable, 8-pos., cable type: PVC

Notes:
For information about the cable qualities, see page 298

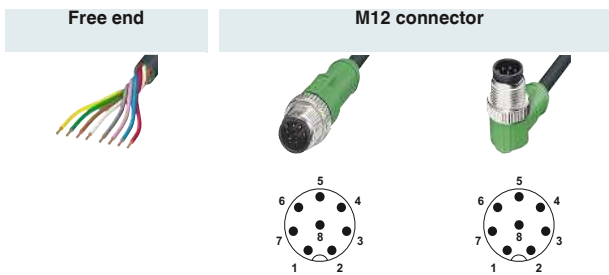

	Ordering data		Ordering data		Ordering data	
Free end	Order No.		Order No.		Order No.	
		1.5 m	1415716	1.5 m	1415720	
		3 m	1415717	3 m	1415721	
		5 m	1415718	5 m	1415722	
		10 m	1415719	10 m	1415723	
		Variable	1522532	Variable	1522587	
M12 socket, straight 		1.5 m	1415724	0.3 m	1415737	
		3 m	1415725	0.6 m	1415738	
		5 m	1415726	1.5 m	1415739	
		10 m	1415727	3 m	1415740	
		Variable	1522613	Variable	1522710	Variable
M12 socket, angled 		1.5 m	1415732	0.3 m	1415745	
		3 m	1415734	0.6 m	1415746	
		5 m	1415735	1.5 m	1415747	
		10 m	1415736	3 m	1415748	
		Variable	1522668	Variable	1522765	Variable

Information for products with fixed cable length:

Products with fixed cable length are produced with the **PVC** cable type and are available from stock.

Ordering data for products with variable cable:

For a sensor/actuator cable, PVC, black, 4.5 m long, with a straight 8-pos. M12 connector and a straight M12 socket, the ordering data is as follows:

Order No.	Cable type	Length [m] Max. 40 m
1522710	PVC	4.5
Minimum order amount = 25		
Increments: 0.2 ... 3 m = 0.1 m > 3 m = 0.5 m		

Cable description	Cable type	Color coding	Pin assignment
PVC - black E221474	PVC	WH	1
		BN	2
PVC - gray E221474	500	GN	3
		YE	4
PUR, halogen-free - black E221474	PUR	GY	5
		PK	6
TPE-U highly flexible - gray E221474	800	BU	7
		RD	8

Technical data	
M12 8-pos.	
Rated voltage [V]	30
Rated current [A]	2
Contact material	CuZn
Contact surface material	Ni/Au
Material of grip body	TPU, hardly inflammable, self-extinguishing
M12 circular connector according to:	IEC 61076-2-101
Degree of protection	IP65 / IP67 / IP68
Temperature data	
Connector/socket [°C]	-25 ... 90

Sensor/actuator cabling

Assembled cables

M8 SAC cable, 8-pos., shielded, cable type: PUR

Notes:

For information about the cable qualities, see page 298

Free end



M8 connector, 360° shielded

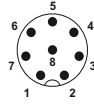

	Ordering data	Ordering data	Ordering data
Free end	Order No.	Order No.	Order No.
	1.5 m	1404137	
	3 m	1404140	
	5 m	1404141	
	10 m	1404138	
	1.5 m	1404147	0.3 m
	3 m	1404148	0.6 m
	5 m	1404149	1.5 m
	10 m	1404150	3 m
			1404133
			1404134

Cable description	Cable type	Color coding	Pin assignment
PUR, halogen free - black	PUR	WH	1
		BN	2
		GN	3
		YE	4
		GY	5
		PK	6
		BU	7
		RD	8

Technical data

		M8 8-pos.
Rated voltage	[V]	30
Rated current	[A]	1.5
Contact material		CuSn
Contact surface material		Ni/Au
Material of grip body		TPU, hardly inflammable, self-extinguishing
Material, knurls		Zinc die-cast, nickel-plated
M8 circular connector according to:		IEC 61076-2-104
Degree of protection		IP65 / IP67
Temperature data		
Connector/socket	[°C]	-25 ... 85

M12 SAC cable, 8-pos., shielded, cable type: PUR

Notes:
For information about the cable qualities, see page 298

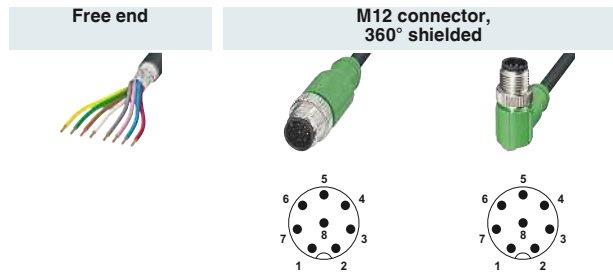

Free end	Ordering data		Ordering data		Ordering data	
	Order No.	Order No.	Order No.	Order No.	Order No.	Order No.
		1.5 m	1522778	1.5 m	1522817	
		3 m	1522781	3 m	1522820	
		5 m	1526981	5 m	1522833	
		10 m	1522794	10 m	1522846	
		Variable	1522804	Variable	1522859	
M12 socket, straight, 360° shielded 	1.5 m	1522862	0.3 m	1522969		
	3 m	1522875	0.6 m	1522972		
	5 m	1522888	1.5 m	1522985		
	10 m	1522891	3 m	1522998		
	Variable	1522901	Variable	1523007	Variable	1551998
M12 socket, angled, 360° shielded 	1.5 m	1522914	0.3 m	1523010		
	3 m	1522927	0.6 m	1523023		
	5 m	1522930	1.5 m	1523036		
	10 m	1522943	3 m	1523049		
	Variable	1522956	Variable	1523052	Variable	1552007

Information for products with fixed cable length:

Products with fixed cable length are produced with the halogen-free PUR cable type and are available from stock.

Ordering data for products with variable cable:

For a shielded sensor/actuator cable, PUR, halogen-free, black, 4.5 m long, with a straight 8-pos. M12 connector and a straight M12 socket, the ordering data is as follows:

Order No.	Cable type	Length [m] Max. 40 m
1523007	PUR	4.5
Minimum order amount = 25		
Increments: 0.2 ... 3 m = 0.1 m > 3 m = 0.5 m		

Cable description	Cable type	Color coding	Pin assignment
PUR, halogen-free - black E221474	PUR	WH	1
		BN	2
PUR, halogen-free - gray E221474	280	GN	3
		YE	4
PVC - black E221474	PVC	GY	5
		PK	6
		BU	7
		RD	8

Technical data	
M12 8-pos., shielded	
Rated voltage [V]	30
Rated current [A]	2
Contact material	CuZn
Contact surface material	Ni/Au
Material of grip body	TPU, hardly inflammable, self-extinguishing
M12 circular connector according to:	IEC 61076-2-101
Degree of protection	IP65 / IP67
Temperature data	
Connector/socket [°C]	-25 ... 90

Sensor/actuator cabling

Assembled cables

M12-SPEEDCON, SAC cable, 12 and 17-pos., cable type: PUR

Notes:
For information about the cable qualities, see page 298



Free end	Ordering data	Ordering data	Ordering data	Ordering data	Ordering data	
	Order No.	Order No.	Order No.	Order No.	Order No.	
	1.5 m	1430530	1.5 m	1430572	1.5 m	1430695
	3 m	1430543	3 m	1430585	3 m	1430705
	5 m	1430556	5 m	1430598	5 m	1430718
	10 m	1430569	10 m	1430608	10 m	1430721
M12 socket, SPEEDCON, 12-pos., straight 	1.5 m	1430611				
	3 m	1430624				
	5 m	1430637				
	10 m	1430640				
M12 socket, SPEEDCON, 12-pos., angled 	1.5 m	1430653				
	3 m	1430666				
	5 m	1430679				
	10 m	1430682				
M12 socket, SPEEDCON, 17-pos., straight 	1.5 m	1430776				
	3 m	1430789				
	5 m	1430792				
	10 m	1430802				
M12 socket, SPEEDCON, 17-pos., angled 	1.5 m	1430815				
	3 m	1430828				
	5 m	1430831				
	10 m	1430844				

Cable description	Cable type	Color coding	Pin assignment, 12-pos.	Color coding	Pin assignment, 17-pos.
PUR halogen-free - black	PUR	BN	1	BN	1
		BU	2	BU	2
		WH	3	WH	3
		GN	4	GN	4
		PK	5	PK	5
		YE	6	YE	6
		BK	7	BK	7
		GY	8	GY	8
		RD	9	RD	9
		VT	10	VT	10
		GYPK	11	GYPK	11
		RDBU	12	RDBU	12
				WHGN	13
				BNGN	14
				WHYE	15
				YEBN	16
				WHGY	17

	Technical data	Technical data
	M12 12-pos.	M12 17-pos.
Rated voltage [V]	30	30
Rated current [A]	1.5	1.5
Contact material	CuZn	CuZn
Contact surface material	Ni/Au	Ni/Au
Material of grip body	TPU, hardly inflammable, self-extinguishing	TPU, hardly inflammable, self-extinguishing
M12 circular connector according to:	IEC 61076-2-101	IEC 61076-2-101
Degree of protection	IP65 / IP67 / IP68	IP65 / IP67 / IP68
Temperature data		
Connector/socket [°C]	-25 ... 90	-25 ... 90

M12-SPEEDCON, SAC cable, 12 and 17-pos., cable type: PVC

Notes:

For information about the cable qualities, see page 298



Free end



M12 connector, SPEEDCON, 12-pos.



M12 connector, SPEEDCON, 17-pos.

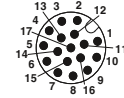
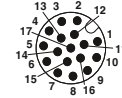

Ordering data

Free end	Order No.	Order No.	Order No.	Order No.	Order No.
	1.5 m	1554775	1.5 m	1554814	1.5 m
	3 m	1554788	3 m	1554827	3 m
	5 m	1554791	5 m	1554830	5 m
	10 m	1554801	10 m	1554843	10 m
M12 socket, SPEEDCON, 12-pos., straight 	1.5 m	1554856			
	3 m	1554869			
	5 m	1554872			
	10 m	1554885			
M12 socket, SPEEDCON, 12-pos., angled 	1.5 m	1554898			
	3 m	1554908			
	5 m	1554924			
	10 m	1554937			
M12 socket, SPEEDCON, 17-pos., straight 	1.5 m	1555347			
	3 m	1555350			
	5 m	1555363			
	10 m	1555376			
M12 socket, SPEEDCON, 17-pos., angled 	1.5 m	1555389			
	3 m	1555392			
	5 m	1555402			
	10 m	1555415			

Cable description	Cable type	Color coding	Pin assignment, 12-pos.	Color coding	Pin assignment, 17-pos.
PVC - black	PVC	BN	1	BN	1
		BU	2	BU	2
		WH	3	WH	3
		GN	4	GN	4
		PK	5	PK	5
		YE	6	YE	6
		BK	7	BK	7
		GY	8	GY	8
		RD	9	RD	9
		VT	10	VT	10
		GYPK	11	GYPK	11
		RDBU	12	RDBU	12
				WHGN	13
				BNGN	14
				WHYE	15
				YEBN	16
				WHGY	17

	Technical data	Technical data
Rated voltage [V]	30	30
Rated current [A]	1.5	1.5
Contact material	CuZn	CuZn
Contact surface material	Ni/Au	Ni/Au
Material of grip body	TPU, hardly inflammable, self-extinguishing	TPU, hardly inflammable, self-extinguishing
M12 circular connector according to:	IEC 61076-2-101	IEC 61076-2-101
Degree of protection	IP65 / IP67 / IP68	IP65 / IP67 / IP68
Temperature data		
Connector/socket [°C]	-25 ... 90	-25 ... 90

Sensor/actuator cabling

Assembled cables

M12-SPEEDCON and M23 SAC cable, 12-pos., shielded

Notes:

For information about the cable qualities, see page 298



	Ordering data	Ordering data	Ordering data	Ordering data	Ordering data
Free end	Order No.	Order No.	Order No.	Order No.	Order No.
		1.5 m 1430048	1.5 m 1430080		
		3 m 1430051	3 m 1430093		
		5 m 1430064	5 m 1430103		
		10 m 1430077	10 m 1430116		
M12 socket, SPEEDCON, straight, 360° shielded					
	0.5 m 1437083			0.5 m 1437287	
	1 m 1434730			1 m 1437290	
	1.5 m 1430129				
	3 m 1430132	3 m 1402551		2 m 1437300	
	5 m 1430145			5 m 1437313	
	10 m 1430158				
M12 socket, SPEEDCON, angled, 360° shielded					
	1.5 m 1430161				
	3 m 1430174				
	5 m 1430187				
	10 m 1430190				
M23 socket, straight, 360° shielded					
		0.5 m 1437326			
		1 m 1437339			
		2 m 1437342			
		5 m 1437355			

Cable description	Cable type	Color coding	Pin assignment	
			M12	M23
PUR/PVC - black, twisted pair	35T	BN	1	1
		BU	2	2
		WH	3	3
		GN	4	4
		PK	5	5
		YE	6	6
		BK	7	7
		GY	8	8
		RD	9	9
		VT	10	10
		GYPK	11	11
		RDBU	12	12

		Technical data	
		M12 12-pos.	M23 12-pos.
Rated voltage	[V]	30	30
Rated current	[A]	1.5	1.5
Contact material		CuZn	CuZn
Contact surface material		Ni/Au	Ni/Au
Material of grip body		TPU, hardly inflammable, self-extinguishing	PUR
M12 circular connector according to:		IEC 61076-2-101	IEC 61076-2-101
Degree of protection		IP65 / IP67	IP65 / IP67
Temperature data			
Connector/socket	[°C]	-25 ... 90	-40 -25 ... 125 90

M12-SPEEDCON and M23 SAC cable, 17-pos., shielded

Notes:
For information about the cable qualities, see page 298

Free end



M12 connector, SPEEDCON, 360° shielded



M23 connector, 360° shielded

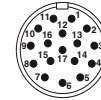

Ordering data

Free end	Order No.	Order No.	Order No.	Order No.	Order No.
	1.5 m	1430200	1.5 m	1430242	
	3 m	1430213	3 m	1430255	
	5 m	1430226	5 m	1430268	
	10 m	1430239	10 m	1430271	

M12 socket, SPEEDCON, straight, 360° shielded

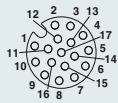

1.5 m	1430284	0.5 m	1437368
3 m	1430297	1 m	1437371
5 m	1430307	2 m	1437384
10 m	1430310	5 m	1437397

M12 socket, SPEEDCON, angled, 360° shielded

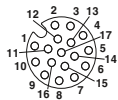

1.5 m	1430323
3 m	1430336
5 m	1430349
10 m	1430352

M23 socket, straight, 360° shielded



0.5 m	1437407
1 m	1437410
2 m	1437423
5 m	1437436

Cable description	Cable type	Color coding	Pin assignment	
			M12	M23
PUR/PVC - black, twisted pair	35T			
		BN	1	1
		BU	2	2
		WH	3	3
		GN	4	4
		PK	5	5
		YE	6	6
		BK	7	7
		GY	8	8
		RD	9	9
		VT	10	10
		GYPK	11	11
		RDBU	12	12
		WHGN	13	13
		BNGN	14	14
		WHYE	15	15
		YEEN	16	16
		WHGY	17	17

	Technical data	Technical data
	M12 17-pos.	M23 17-pos.
Rated voltage [V]	30	30
Rated current [A]	1.5	1.5
Contact material	CuZn	CuZn
Contact surface material	Ni/Au	Ni/Au
Material of grip body	TPU, hardly inflammable, self-extinguishing	PUR
M12 circular connector according to:	IEC 61076-2-101	IEC 61076-2-101
Degree of protection	IP65 / IP67	IP65 / IP67
Temperature data		
Connector/socket [°C]	-25 ... 90	-40 -25 ... 125 90

Sensor/actuator cabling

Assembled cables

M17 and M23 plastic molded signal connectors

- Feedback connectors
- Contact material gold-plated CuZn
- Flame-retardant TPU handle material
- Knurl CuZn/Gd-Zn, nickel-plated
- IP67 protection
- Plug head temperature range -40°C to +105°C
- Standard and counter direction contact numbering
- M17 and M23 standard thread - SPEEDCON fast locking system on request
- Angled versions rotatable

M17, 17-position, socket, standard, 60 V, 3.6 A

M23, 12-position, socket, counter direction, 150 V, 9 A

M23, 12-position, socket, counter direction, 150 V, 9 A



E01

E00

E00

Ordering data

Ordering data

Ordering data

Order No.

Order No.

Order No.

Free end



2 m [1624780](#)
5 m [1624781](#)
10 m [1624782](#)

2 m [1619247](#)
5 m [1619248](#)
10 m [1619249](#)

2 m [1619280](#)
5 m [1619281](#)
10 m [1619282](#)

M17, 17-pos., pin



2 m [1624778](#)
5 m [1624783](#)
10 m [1624784](#)

M23, 12-pos., pin



2 m [1619289](#)
5 m [1619290](#)
10 m [1619291](#)

M23, 12-pos., pin







M23, 17-pos., pin



Cable information:

Type/application	Color	Structure	Sheath/core material	Assignment	Temperature range
E00 Feedback	Orange	Shielded, 4 x 2 x 0.25 + 2 x 0.5	TPU/PP	1 - pink 2 - red 3 - black 4 - blue 5 - brown 6 - green 7 - violet 8 - gray 9 - exterior shield 10 - white 11 - n.c. 12 - brown	Mobile: -20°C ... 60°C Fixed: -40°C ... 80°C
E01 Feedback	Green	Shielded, 3 x 2 x 0.14 + 2 x 0.5 + 4 x 0.14 + 4 x 0.22	TPU/TPM	1 - yellow 2 - green 3 - red 4 - n.c. 5 - blue 6 - n.c. 7 - brown-blue (encoder) 8 - green-black (+temp.) 9 - green-red (-temp.) 10 - brown-red (P encoder) 11 - black 12 - brown 13 - orange 14 - white-black 15 - brown-gray (OV sense) 16 - brown-yellow (sense) 17 - n.c. Inner shield on housing	Mobile: -30°C ... 60°C Fixed: -30°C ... 80°C

M23, 12-position, socket, standard, 150 V, 9 A		M23, 12-position, socket, standard, 150 V, 9 A		M23, 17-position, socket, standard, 100 V, 9 A		M23, 17-position, socket, standard, 100 V, 9 A	
							
E00		E00		E01		E01	
Ordering data		Ordering data		Ordering data		Ordering data	
Order No.		Order No.		Order No.		Order No.	
2 m	1619250	2 m	1619285	2 m	1619277	2 m	1619286
5 m	1619273	5 m	1619283	5 m	1619278	5 m	1619287
10 m	1619274	10 m	1619284	10 m	1619279	10 m	1619288
2 m	1619292						
5 m	1619293						
10 m	1619294						
				2 m	1619295		
				5 m	1619296		
				10 m	1619297		

Sensor/actuator cabling

Assembled cables

M17 plastic molded power connectors

- Contact material gold-plated CuZn
- Flame-retardant TPU handle material
- Knurl CuZn/Gd-Zn, nickel-plated
- IP67 protection
- Plug head temperature range -40°C to +105°C
- Standard contact numbering
- M17 standard thread - SPEEDCON fast locking system on request

M17, 3+PE-position, socket, standard, 630 V, 18 A

M17, 3+PE-position, socket, standard, 630 V, 26 A

M17, 5+PE-position, socket, standard, 630 V, 12 A



B00

B01

C00

Ordering data

Ordering data

Ordering data

Order No.

Order No.

Order No.

Free end



Length	Order No.	Order No.	Order No.
2 m	1619298	1619301	1619307
5 m	1619299	1619302	1619308
10 m	1619300	1619303	1619309

M17, 3+PE-pos., pin



Length	Order No.	Order No.
2 m	1619304	1619326
5 m	1619305	1619327
10 m	1619306	1619328

M17, 5+PE-pos., pin



Length	Order No.
2 m	1619316
5 m	1619317
10 m	1619318

M17, 7+PE-pos., pin



Cable information:

Type	Color	Structure	Sheath/core material	Assignment	Temperature range
B00 Servo	Orange	Shielded, 4 x 1.50	PUR/TPM	1 - black U 2 - black V 3 - black W	Mobile: -20°C ... 60°C Fixed: -40°C ... 80°C
B01 Servo	Orange	Shielded, 4 x 2.50	TPU/TPM	PE - green/yellow"	Mobile: -20°C ... 70°C Fixed: -50°C ... 80°C
C00 Servo	Orange	Shielded, 4 x 0.75 + 2 x 0.5	PUR/TPM	1 - black U 6 - black V 7 - black W	Mobile: -30°C ... 70°C Fixed: -40°C ... 80°C
C01 Servo	Orange	Shielded, 4G1 + 2 x 0.5	PUR/TPE	PE - green/yellow	Mobile: -5°C ... 70°C Fixed: -30°C ... 70°C
D00 Servo	Orange	Shielded, 4 x 0.75 + 2 x 2 x 0.34	PUR/TPM	1 - black U 2 - black V 3 - black W	Mobile: -30°C ... 90°C Fixed: -40°C ... 80°C
D01 Servo	Orange	Shielded, 4 x 1.0 + 2 x 2 x 0.75	PUR/TPM	PE - green/yellow	Mobile: -20°C ... 60°C Fixed: -40°C ... 80°C

M17, 5+PE-position,
socket, standard,
630 V, 15 A



C01

Ordering data

Order No.

2 m [1619310](#)
5 m [1619311](#)
10 m [1619312](#)

M17, 4+3+PE-position,
socket, standard,
630 V, 12 A



D00

Ordering data

Order No.

2 m [1624785](#)
5 m [1624786](#)
10 m [1624792](#)

M17, 4+3+PE-position,
socket, standard,
630 V, 15 A



D01

Ordering data

Order No.

2 m [1619313](#)
5 m [1619314](#)
10 m [1619315](#)

2 m [1619319](#)
5 m [1619321](#)
10 m [1619322](#)

2 m [1624787](#)
5 m [1624788](#)
10 m [1624789](#)

2 m [1619323](#)
5 m [1619324](#)
10 m [1619325](#)

Sensor/actuator cabling

Assembled cables

M23 plastic molded power connectors

- Contact material gold-plated CuZn
- Flame-retardant TPU handle material
- Knurl CuZn/Gd-Zn, nickel-plated
- IP67 protection
- Plug head temperature range -40°C to +105°C
- Standard contact numbering
- M23 standard thread - SPEEDCON fast locking system on request
- Angled version rotatable (only with reinforced device connector [1620619](#))

M23, 3+PE-position, socket, standard, 630 V, 34 A

M23, 4+PE-position, socket, standard, 630 V, 34 A

M23, 5+PE-position, socket, standard, 630 V, 18 A



A00

A01

C02

Ordering data

Ordering data

Ordering data

Order No.

Order No.

Order No.

Free end



2 m	1624771
5 m	1619622
10 m	1624772

2 m	1625776
5 m	1625777
10 m	1625775

2 m	1618957
5 m	1618958
10 m	1618959

M23, 3+PE-pos., pin



2 m	1624773
5 m	1619606
10 m	1624774

M23, 4+PE-pos., pin



2 m	1625779
5 m	1625781
10 m	1625780

M23, 5+PE-pos., pin



2 m	1618964
5 m	1618965
10 m	1618966

Cable information:

Type	Color	Structure	Sheath/core material	Assignment	Temperature range
A00 Energy	Gray	Shielded, 4 x 4.0	PVC/PVC	1 - nc 2 - black 3 PE - green/yellow	4 - black 1 5 - black 2 6 - nc Fixed: -40°C ... 90°C
A01 Energy	Gray	5 x 4.0	PVC/PVC	1 - black 4 2 - black 3 PE - green/yellow	4 - black 1 5 - black 2 6 - nc Fixed: -40°C ... 90°C
C02 Servo	Orange	Shielded, 4 x 1.50 + 2 x 1.5	PUR/TPM	1 - black U 2 - black V 6 - black W PE - green/yellow	4 - black, (BR1 brake) 5 - white, (BR2 brake) Flexible: -20°C ... 60°C Fixed: -40°C ... 80°C
C03 Servo	Orange	Shielded, 4 x 2.50 + 2 x 1.5	TPU/TPM		Flexible: -20°C ... 70°C Fixed: -50°C ... 80°C

M23, 5+PE-position,
socket, standard,
630 V, 18 A

M23, 5+PE-position,
socket, standard,
630 V, 26 A

M23, 5+PE-position,
socket, standard,
630 V, 26 A



C02

C03

C03

Ordering data

Ordering data

Ordering data

Order No.

Order No.

Order No.

2 m [1620415](#)
5 m [1620416](#)
10 m [1620417](#)

2 m [1620396](#)
5 m [1620397](#)
10 m [1620398](#)

2 m [1620418](#)
5 m [1620419](#)
10 m [1620420](#)

2 m [1620406](#)
5 m [1620407](#)
10 m [1620408](#)

Sensor/actuator cabling

Assembled cables

M23 plastic molded power connectors

- Contact material gold-plated CuZn
- Flame-retardant TPU handle material
- Knurl CuZn/Gd-Zn, nickel-plated
- IP67 protection
- Plug head temperature range -40°C to +105°C
- Standard contact numbering
- M23 standard thread - SPEEDCON fast locking system on request
- Angled version rotatable (only with reinforced device connector 1620620)

	M23, 4+3+PE-position, socket, standard, 250 V/630 V, 18 A	M23, 4+3+PE-position, socket, standard, 250 V/630 V, 18 A	M23, 4+3+PE-position, socket, standard, 250 V/630 V, 26 A
			
	D02	D02	D03
	Ordering data	Ordering data	Ordering data
	Order No.	Order No.	Order No.
Free end 	2 m 1620399 5 m 1620400 10 m 1620401	2 m 1620421 5 m 1620422 10 m 1620423	2 m 1620402 5 m 1620404 10 m 1620405
M23, 4+3+PE-pos., pin 	2 m 1620409 5 m 1620410 10 m 1620411		2 m 1620412 5 m 1620413 10 m 1620414

Cable information:

Type	Color	Structure	Sheath/core material	Assignment		Temperature range
D02 Servo	Orange	Shielded, 4 x 1.5 + 2 x 2 x 0.75	PUR/TPM	1 - black U 3 - black V 4 - black W	A - black 5 (brake) B - black 6 (brake) C - black 7 (motor temp. +) D - black 8 (motor temp. -)	Flexible: -20°C ... 60°C Fixed: -40°C ... 80°C
D03 Servo	Orange	Shielded, 4 x 2.5 + 2 x 2 x 0.75	PUR/TPM	PE - green/yellow		Flexible: -20°C ... 60°C Fixed: -40°C ... 80°C

M23, 4+3+PE-position,
socket, standard,
250 V/630 V, 26 A



D03

Ordering data

Order No.

2 m	1620424
5 m	1620425
10 m	1620426

Sensor/actuator cabling

Assembled cables

M40 plastic molded power connectors



- Contact material gold-plated CuZn
- Flame-retardant TPU handle material
- Knurl CuZn/Gd-Zn, nickel-plated
- IP67 protection
- Plug head temperature range -40°C to +105°C
- Standard contact numbering
- M40 standard thread - SPEEDCON fast locking system on request

M40, 2+3+PE-position, socket, standard, 250 V/630 V, 26 A

M40, 2+3+PE-position, socket, standard, 250 V/630 V, 34 A

M40, 2+3+PE-position, socket, standard, 250 V/630 V, 44 A



	C03		C04		C05	
	Ordering data		Ordering data		Ordering data	
	Order No.		Order No.		Order No.	
Free end						
	2 m	1619329	2 m	1620311	2 m	1620316
	5 m	1620309	5 m	1620313	5 m	1620317
	10 m	1620310	10 m	1620314	10 m	1620318
M40, 2+3+PE-pos., pin						
	2 m	1620345	2 m	1620348	2 m	1620376
	5 m	1620346	5 m	1620349	5 m	1620377
	10 m	1620347	10 m	1620375	10 m	1620378
M40, 4+3+PE-pos., pin						
						

Cable information:

Type	Color	Structure	Sheath/core material	Assignment	Temperature range	
C03 Servo	Orange	Shielded, 4 x 2.50 + 2 x 1.5	TPU/TPM	U - black U V - black V W - black W PE - green/yellow	+ - black, (BR1) -- white, (BR2)	Mobile: -20°C ... 70°C Fixed: -50°C ... 80°C
C04 Servo	Orange	Shielded, 4 x 4.00 + 2 x 1.5	TPU/TPM		Mobile: -20°C ... 70°C Fixed: -50°C ... 80°C	
C05 Servo	Orange	Shielded, 4 x 6.00 + 2 x 1.5	PUR/TPE		Mobile: -40°C ... 80°C Fixed: -50°C ... 90°C	
C06 Servo	Orange	Shielded, 4 x 10.0 + 2 x 1.5	TPU/TPM		Mobile: -20°C ... 70°C Fixed: -50°C ... 80°C	
D03 Servo	Orange	Shielded, 4 x 2.5 + 2 x 2 x 0.75	PUR/TPM	U - black 1 V - black 2 W - black 3 PE - green/yellow	+ - black 5 (brake) -- black 6 (brake) 1 - black 7 (motor temp. +) 2 - black 8 (motor temp. -)	Mobile: -20°C ... 60°C Fixed: -40°C ... 80°C
D04 Servo	Orange	Shielded, 4 x 4.0 + 2 x 1.5 + 2 x 1.0	PUR/TPM		Mobile: -30°C ... 80°C Fixed: -45°C ... 80°C	
D05 Servo	Orange	Shielded, 4 x 6.0 + 2 x 1.5 + 2 x 1.0	PUR/TPM		Mobile: -30°C ... 60°C Fixed: -30°C ... 80°C	
D06 Servo	Orange	Shielded, 4 x 10 + 2 x 1.5 + 2 x 1.0	PUR/TPM		Mobile: -20°C ... 60°C Fixed: -40°C ... 80°C	

M40, 2+3+PE-position,
socket, standard,
250 V/630 V, 61 A



C06

Ordering data

Order No.

2 m [1620319](#)
5 m [1620320](#)
10 m [1620321](#)

M40, 4+3+PE-position,
socket, standard,
250 V/630 V, 26 A



D03

Ordering data

Order No.

2 m [1620322](#)
5 m [1620323](#)
10 m [1620324](#)

M40, 4+3+PE-position,
socket, standard,
250 V/630 V, 34 A



D04

Ordering data

Order No.

2 m [1620325](#)
5 m [1620337](#)
10 m [1620338](#)

M40, 4+3+PE-position,
socket, standard,
250 V/630 V, 44 A



D05

Ordering data

Order No.

2 m [1620339](#)
5 m [1620340](#)
10 m [1620341](#)

M40, 4+3+PE-position,
socket, standard,
250 V/630 V, 61 A



D06

Ordering data

Order No.

2 m [1620342](#)
5 m [1620343](#)
10 m [1620344](#)

2 m [1620379](#)
5 m [1620380](#)
10 m [1620381](#)

2 m [1620382](#)
5 m [1620383](#)
10 m [1620384](#)

2 m [1620385](#)
5 m [1620386](#)
10 m [1620387](#)

2 m [1620390](#)
5 m [1620391](#)
10 m [1620392](#)

2 m [1620393](#)
5 m [1620394](#)
10 m [1620395](#)

Sensor/actuator cabling

Assembled cables

Plastic molded M23 hybrid connectors





- Transmission of signals, data (CAT5), and power
- Rated voltage: 630 V AC/850 V DC
- Contact material gold-plated CuZn
- Flame-retardant TPU handle material
- Knurl CuZn/Gd-Zn, nickel-plated
- IP67 protection
- Plug head temperature range -40°C to +105°C
- SPEEDCON fast locking system, M23 standard thread on request
- Angled version can be rotated

M23, 4+4+4+PE-position, socket, standard, 50 V/630 V, 26 A

M23, 4+4+4+PE-position, pin, standard, 50 V/630 V, 26 A

M23, 4+4+4+PE-position, socket, standard, 50 V/630 V, 26 A



	H00		H00		H00	
	Ordering data		Ordering data		Ordering data	
	Order No.		Order No.		Order No.	
Free end						
	2 m	1622224	2 m	1622227	2 m	1622230
	5 m	1622225	5 m	1622228	5 m	1622231
	10 m	1622226	10 m	1622229	10 m	1622232
M23, 4+4+4+PE-pos., pin						
	2 m	1622244				
	5 m	1622245				
	10 m	1622246				
M23, 4+4+4+PE-pos., pin						
	2 m	1622247				
	5 m	1622248				
	10 m	1622249				
M23, 4+4+4+PE-pos., pin						
					2 m	1622250
					5 m	1622251
					10 m	1622252

Cable information:

Type	Color	Structure	Sheath/core material	Assignment		Temperature range
H00 Hybrid	Orange	Shielded, 5 x 2.5 + 4 x 22 AWG/C + 4 x 0.5	PUR/TPE, polyolefin	A - black BK1 (2.5 mm ²) B - black BK2 (2.5 mm ²) C - black BK3 (2.5 mm ²) D - black BK4 (2.5 mm ²) PE - green/yellow (2.5 mm ²)	1 - brown BN (0.5 mm ²) 2 - violet VT (0.5 mm ²) 3 - black BK (0.5 mm ²) 4 - green GN (0.5 mm ²) 5 - blue BU (0.34 mm ²) 6 - yellow YE (0.34 mm ²) 7 - white WH (0.34 mm ²) 8 - orange OG (0.34 mm ²)	Mobile: -30°C ... 60°C Fixed: -40°C ... 80°C

M23, 4+4+4+PE-position,
pin, standard, 50 V/630 V,
26 A



H00

Ordering data

Order No.

2 m	1622233
5 m	1622234
10 m	1622243

Sensor/actuator cabling

Assembled cables

Valve connector with Zener diode, cable type: PUR

Notes:
For information about the cable qualities, see page 298



		Ordering data		Ordering data		Ordering data		Ordering data		Ordering data	
Type	Diagram	Length	Order No.	Length	Order No.	Length	Order No.	Length	Order No.	Length	Order No.
Type A		1.5 m	1434989	0.3 m	1434882	0.3 m	1434934	Variable	1405650		
		3 m	1434992	0.6 m	1434895	0.6 m	1434947				
		5 m	1435001	1.5 m	1434905	1.5 m	1434950				
		10 m	1435014	3 m	1434918	3 m	1434963				
		Variable	1435027	Variable	1434921	Variable	1434976				
Type B		1.5 m	1435386	0.3 m	1435289	0.3 m	1435331	Variable	1405651		
		3 m	1435399	0.6 m	1435292	0.6 m	1435344				
		5 m	1435409	1.5 m	1435302	1.5 m	1435357				
		10 m	1435412	3 m	1435315	3 m	1435360				
		Variable	1435425	Variable	1435328	Variable	1435373				
Type BI		1.5 m	1435234	0.3 m	1435137	0.3 m	1435182	Variable	1405652		
		3 m	1435247	0.6 m	1435140	0.6 m	1435195				
		5 m	1435250	1.5 m	1435153	1.5 m	1435205				
		10 m	1435263	3 m	1435166	3 m	1435218				
		Variable	1435276	Variable	1435179	Variable	1435221				
Type C		1.5 m	1435535	0.3 m	1435438	0.3 m	1435483	Variable	1405653		
		3 m	1435548	0.6 m	1435441	0.6 m	1435496				
		5 m	1435551	1.5 m	1435454	1.5 m	1435506				
		10 m	1435564	3 m	1435467	3 m	1435519				
		Variable	1435726	Variable	1435629	Variable	1435674				
Type CI		1.5 m	1435687	0.3 m	1435580	0.3 m	1435632	Variable	1405654		
		3 m	1435690	0.6 m	1435593	0.6 m	1435645				
		5 m	1435700	1.5 m	1435603	1.5 m	1435658				
		10 m	1435713	3 m	1435616	3 m	1435661				
		Variable	1435577	Variable	1435470	Variable	1435522				

Information for products with fixed cable length:

Products with fixed cable length are produced with the halogen-free PUR cable type and are available from stock.

Ordering data for type A, B, BI, C, CI valve connector cables with variable cable:

For a sensor/actuator cable, PUR, halogen-free, black, 4.5 m long, type A valve connector with Zener diode and a 3-pos. straight M12 connector, the ordering data is as follows:

Order No.	Cable type	Length [m] Max. 40 m
1434921	PUR	4.5
Minimum order amount = 25		
Increments: 0.2 ... 3 m = 0.1 m > 3 m = 0.5 m		

Cable description	Cable type	M12				Color coding	Pin assignment M12
		M8	A	B(I)	C(I)		
PUR, halogen-free - black, 0.5 mm ²	PUR	x	x	x	x	BK1: 1 BK2: 2 GNYE: 3, 4, 5	3 4 5
PUR, halogen-free - black, 1.0 mm ²	121	x	x				
PUR, halogen-free - yellow, 0.5 mm ²	240	x	x	x	x		
PUR, halogen-free - gray, 0.5 mm ²	280	x	x	x	x		
PUR irradiated - orange, 0.5 mm ²	150	x	x	x	x		
PUR, highly flexible - gray, 0.5 mm ²	800	x	x	x	x		
PVC - black, 0.5 mm ²	PVC	x	x	x	x	BU: 3 BN: 4	3 4
PVC - black, 0.75 mm ²	534	x	x	x	x		
PVC - gray, 0.5 mm ²	500	x	x	x	x		

Technical data

Connector	
Rated voltage	[V] 24
Rated current	[A] 4
Contact material	CuSn
Material contact surface M12	Ni/Au
Material contact surface valve connector	Sn
Material of grip body	TPU
Material, knurls	Zinc die-cast, nickel-plated
Degree of protection	IP65 / IP67
Temperature data	
Connector/socket	[°C] -25 ... 90
Valve connectors	[°C] -20 ... 85

Valve connector with Zener diode, cable type: PVC

Notes:
For information about the cable qualities, see page 298

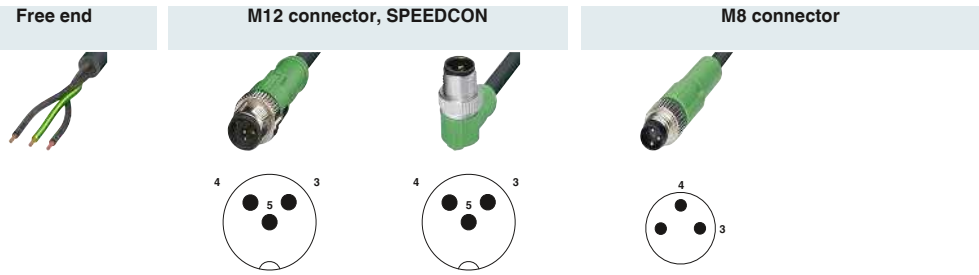

		Ordering data		Ordering data		Ordering data		Ordering data	
Type A		Order No.	Order No.	Order No.	Order No.	Order No.	Order No.	Order No.	Order No.
		1.5 m	1438684						
		3 m	1415905						
		5 m	1439502						
		10 m	1439492						
		Variable	1435027	Variable	1434921	Variable	1434976	Variable	1405650
		1.5 m	1415922						
		3 m	1415923						
		5 m	1415924						
		10 m	1400610						
		Variable	1435425	Variable	1435328	Variable	1435373	Variable	1405651
		1.5 m	1415929						
		3 m	1400609						
		5 m	1415930						
		10 m	1400607						
		Variable	1435276	Variable	1435179	Variable	1435221	Variable	1405652
		1.5 m	1439162						
		3 m	1439515						
		5 m	1439528						
		10 m	1439531						
		Variable	1435726	Variable	1435629	Variable	1435674	Variable	1405653
		1.5 m	1439175						
		3 m	1415939						
		5 m	1415940						
		10 m	1400605						
		Variable	1435577	Variable	1435470	Variable	1435522	Variable	1405654

Information for products with fixed cable length:

Products with fixed cable length are produced with the PVC cable type and are available from stock.

Ordering data for type A, B, BI, C, CI valve connector cables with variable cable:

For a sensor/actuator cable, PVC, black, 4.5 m long, type A valve connector with Zener diode and a 3-pos. straight M12 connector, the ordering data is as follows:

Order No.	Cable type	Length [m] Max. 40 m
1434921	PVC	4.5
Minimum order amount = 25 Increments: 0.2 ... 3 m = 0.1 m > 3 m = 0.5 m		

Cable description	Cable type	M8	M12	A	B(I)	C(I)
PVC - black, 0.5 mm ²	PVC	x	x	x	x	x
PVC - black, 0.75 mm ²	534		x	x	x	x
PVC - gray, 0.5 mm ²	500		x	x	x	x
PUR, halogen-free - black, 0.5 mm ²	PUR	x	x	x	x	x
PUR, halogen-free - black, 1.0 mm ²	121		x	x		
PUR, halogen-free - yellow, 0.5 mm ²	240		x	x	x	x
PUR, halogen-free - gray, 0.5 mm ²	280		x	x	x	x
PUR irradiated - orange, 0.5 mm ²	150		x	x	x	x
PUR, highly flexible - gray, 0.5 mm ²	800		x	x	x	x

Color coding		Pin assignment M12
BK1	1	3
BK2	2	4
GNYE		5

Color coding M8		Pin assignment M8
BU		3
BN		4

Technical data	
Connector	
Rated voltage	[V] 24
Rated current	[A] 4
Contact material	CuSn
Material contact surface M12	Ni/Au
Material contact surface valve connector	Sn
Material of grip body	TPU
Material, knurls	Zinc die-cast, nickel-plated
Degree of protection	IP65 / IP67
Temperature data	
Connector/socket	[°C] -25 ... 90
Valve connectors	[°C] -20 ... 85

Sensor/actuator cabling

Assembled cables

Valve connector with 24 V varistor, cable type: PUR

Notes:
For information about the cable qualities, see page 298

Free end

M12 connector, SPEEDCON

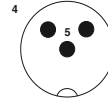
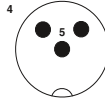

		Ordering data		Ordering data		Ordering data	
Type	Diagram	Length	Order No.	Order No.	Order No.	Order No.	Order No.
Type A		1.5 m	1443103				
		3 m	1443116				
		5 m	1443129				
		10 m	1443132				
		Variable	1400876	Variable	1400874	Variable	1400875
Type B		1.5 m	1443145				
		3 m	1443158				
		5 m	1443161				
		10 m	1443174				
		Variable	1400882	Variable	1400880	Variable	1400881
Type BI		1.5 m	1443187				
		3 m	1443190				
		5 m	1443200				
		10 m	1443213				
		Variable	1400879	Variable	1400877	Variable	1400878
Type C		1.5 m	1443226				
		3 m	1443239				
		5 m	1443242				
		10 m	1443255				
		Variable	1400894	Variable	1400892	Variable	1400893
Type CI		1.5 m	1443268				
		3 m	1443271				
		5 m	1443284				
		10 m	1443297				
		Variable	1400891	Variable	1400889	Variable	1400890

Information for products with fixed cable length:

Products with fixed cable length are produced with the halogen-free PUR cable type and are available from stock.

Ordering data for type A, B, BI, C, CI valve connector cables with variable cable:

For a sensor/actuator cable, PUR, halogen-free, black, 4.5 m long, type B valve connector with 24 V varistor and a 3-pos. straight M12 connector, the ordering data is as follows:

Order No.	Cable type	Length [m] Max. 40 m
1400880	PUR	4.5
Minimum order amount = 25		
Increments: 0.2 ... 3 m = 0.1 m > 3 m = 0.5 m		

Cable description	Cable type	Color coding	Pin assignment
PUR, halogen-free - black, 0.5 mm ²	PUR	BK1 1 BK2 2 GNYE	3 4 5
PUR, halogen-free - black, 1.0 mm ² Type A valve connector only	121		
PUR, halogen-free - yellow, 0.5 mm ²	240		
PUR, halogen-free - gray, 0.5 mm ²	280		
PUR irradiated - orange, 0.5 mm ²	150		
PUR, highly flexible - gray, 0.5 mm ²	800		
PVC - black, 0.5 mm ²	PVC		
PVC - black, 0.75 mm ²	534		
PVC - gray, 0.5 mm ²	500		

Technical data

Connector	
Rated voltage	[V] 24
Rated current	[A] 4
Contact material	CuSn
Material contact surface M12	Ni/Au
Material contact surface valve connector	Sn
Material of grip body	TPU
Material, knurls	Zinc die-cast, nickel-plated
Degree of protection	IP65 / IP67
Temperature data	
Connector/socket	[°C] -25 ... 90
Valve connectors	[°C] -20 ... 85

Valve connector with 24 V varistor, cable type: PVC

Notes:
For information about the cable qualities, see page 298

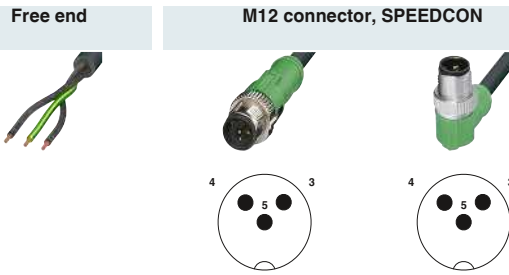

		Ordering data		Ordering data		Ordering data	
		Order No.		Order No.		Order No.	
Type A		10 m	1415908				
		10 m	1415909				
		10 m	1415910				
		10 m	1415911				
		Variable	1400876	Variable	1400874	Variable	1400875
Type B		1.5 m	1415925				
		3 m	1415926				
		5 m	1415927				
		10 m	1415928				
		Variable	1400882	Variable	1400880	Variable	1400881
Type BI		1.5 m	1415931				
		3 m	1415932				
		5 m	1415933				
		10 m	1415934				
		Variable	1400879	Variable	1400877	Variable	1400878
Type C		1.5 m	1415935				
		3 m	1415936				
		5 m	1415937				
		10 m	1415938				
		Variable	1400894	Variable	1400892	Variable	1400893
Type CI		1.5 m	1415941				
		3 m	1415942				
		5 m	1415943				
		10 m	1415944				
		Variable	1400891	Variable	1400889	Variable	1400890

Information for products with fixed cable length:

Products with fixed cable length are produced with the PVC cable type and are available from stock.

Ordering data for type A, B, BI, C, CI valve connector cables with variable cable:

For a sensor/actuator cable, PVC, black, 4.5 m long, type B valve connector with 24 V varistor and a 3-pos. straight M12 connector, the ordering data is as follows:

Order No.	Cable type	Length [m] Max. 40 m
1400880	PVC	4.5
Minimum order amount = 25		
Increments: 0.2 ... 3 m = 0.1 m > 3 m = 0.5 m		

Cable description	Cable type	Color coding	Pin assignment
PVC - black, 0.5 mm ²	PVC	BK1 1, BK2 2	3, 4, 5
PVC - black, 0.75 mm ²	534		
PVC - gray, 0.5 mm ²	500		
PUR, halogen-free - black, 0.5 mm ²	PUR		
PUR, halogen-free - black, 1.0 mm ² Type A valve connector only	121		
PUR, halogen-free - yellow, 0.5 mm ²	240		
PUR, halogen-free - gray, 0.5 mm ²	280		
PUR irradiated - orange, 0.5 mm ²	150		
PUR, highly flexible - gray, 0.5 mm ²	800		

Technical data	
Connector	
Rated voltage	[V] 24
Rated current	[A] 4
Contact material	CuSn
Material contact surface M12	Ni/Au
Material contact surface valve connector	Sn
Material of grip body	TPU
Material, knurls	Zinc die-cast, nickel-plated
Degree of protection	IP65 / IP67
Temperature data	
Connector/socket	[°C] -25 ... 90
Valve connectors	[°C] -20 ... 85

Sensor/actuator cabling

Assembled cables

Valve connector with 230 V varistor, cable type: PUR

Notes:

For information about the cable qualities, see page 298

Free end



Ordering data

Type A



	Order No.
1.5 m	1402985
3 m	1400694
5 m	1400648
10 m	1402986

Technical data

		Connector
Rated voltage	[V]	230
Rated current	[A]	4
Material contact surface valve connector		Sn
Degree of protection		IP65 / IP67
Temperature data		
Valve connectors	[°C]	-20 ... 85

Valve connector with 230 V varistor, cable type: PVC

Notes:

For information about the cable qualities, see page 298

Free end

Ordering data
Type A

	Order No.
1.5 m	1415912
3 m	1415913
5 m	1415914
10 m	1415915

Technical data

		Connector
Rated voltage	[V]	230
Rated current	[A]	4
Material contact surface valve connector		Sn
Degree of protection		IP65 / IP67
Temperature data		
Valve connectors	[°C]	-20 ... 85

Sensor/actuator cabling

Assembled cables

Valve connector with energy-reducing function, 1 A





Free end
1 A



Notes:

For information about the cable qualities, see page 298

Ordering data

Type	Order No.
Type A 	1.5 m 1413115
	3 m 1413114
	5 m 1413116
	10 m 1413118
Type B 	1.5 m 1401294
	3 m 1401295
	5 m 1401338
	10 m 1401339
Type BI 	1.5 m 1401340
	3 m 1401350
	5 m 1401358
	10 m 1401359
Type C 	1.5 m 1401434
	3 m 1401435
	5 m 1401448
	10 m 1401465
Type CI 	1.5 m 1401466
	3 m 1401542
	5 m 1401544
	10 m 1401617

Technical data

		Connector
Rated voltage	[V]	24
Rated current	[A]	1
Material contact surface valve connector		Ag
Degree of protection		IP67
Temperature data		
Valve connectors	[°C]	-25 ... 80

**Valve connector
with energy-reducing function,
4 A**

Free end
4 A



Notes:

For information about the cable qualities, see page 298

Ordering data

Type A		Order No.
	1.5 m	1400827
	3 m	1401131
	5 m	1401136
	10 m	1401168

Technical data

		Connector
Rated voltage	[V]	24
Rated current	[A]	4
Material contact surface valve connector		Ag
Degree of protection		IP67
Temperature data		
Valve connectors	[°C]	-25 ... 80

Sensor/actuator cabling

Assembled cables

Valve connector with freewheeling diode, cable type: PUR

Notes:

For information about the cable qualities, see page 298

Free end



Type A



Ordering data

	Order No.
1.5 m	1400589
3 m	1400588
5 m	1400798
10 m	1400799

Technical data

		Connector
Rated voltage	[V]	24
Rated current	[A]	2
Material contact surface valve connector		Sn
Degree of protection		IP65 / IP67
Temperature data		
Valve connectors	[°C]	-20 ... 85

**Valve connector
with freewheeling diode,
cable type: PVC**

Free end



Notes:

For information about the cable qualities, see page 298

Ordering data

Type A



	Order No.
1.5 m	1415916
3 m	1415917
5 m	1415918
10 m	1415919

Technical data

Connector

Rated voltage	[V]	24
Rated current	[A]	2
Material contact surface valve connector		Sn
Degree of protection		IP65 / IP67
Temperature data		
Valve connectors	[°C]	-20 ... 85

Sensor/actuator cabling

Assembled cables

Valve connector without wiring, cable type: PUR

Notes:
For information about the cable qualities, see page 298

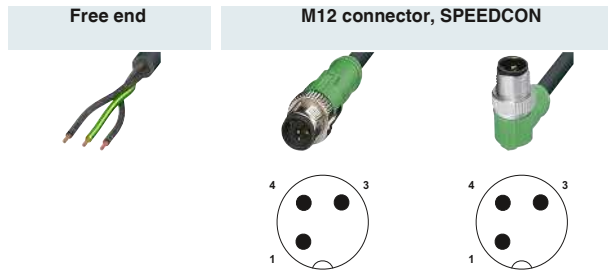

		Ordering data		Ordering data		Ordering data	
Type	Diagram	Length	Order No.	Length	Order No.	Length	Order No.
Type A		1.5 m	1402983	Variable	1400895	Variable	1400896
		3 m	1439544				
		5 m	1402984				
		10 m	1400732				
Type B		Variable	1400909	Variable	1400903	Variable	1400905
Type BI		5 m	1439065	Variable	1400900	Variable	1400901
		10 m	1438862				
		Variable	1400902				
Type C		5 m	1400814	Variable	1400919	Variable	1400920
		10 m	1400641				
		Variable	1400921				
Type CI		Variable	1400918	Variable	1400916	Variable	1400917

Information for products with fixed cable length:

Products with fixed cable length are produced with the halogen-free PUR cable type and are available from stock.

Ordering data for type A, B, BI, C, CI valve connector cables with variable cable:

For a sensor/actuator cable, PUR, halogen-free, black, 4.5 m long, unwired type C valve connector and a 3-pos. straight M12 connector, the ordering data is as follows:

Order No.	Cable type	Length [m] Max. 40 m
1400919	PUR	4.5

Minimum order amount = 25

Increments:
0.2 ... 3 m = 0.1 m
> 3 m = 0.5 m

Cable description	Cable type	Color coding	Pin assignment
PUR, halogen-free - black, 0.5 mm ²	PUR	BK1 1 BK2 2 GNYE	3 4 5
PUR, halogen-free - black, 1.0 mm ² Type A valve connector only	121		
PUR, halogen-free - yellow, 0.5 mm ²	240		
PUR, halogen-free - gray, 0.5 mm ²	280		
PUR irradiated - orange, 0.5 mm ²	150		
PUR, highly flexible - gray, 0.5 mm ²	800		
PVC - black, 0.5 mm ²	PVC		
PVC - black, 0.75 mm ²	534		
PVC - gray, 0.5 mm ²	500		

Technical data	
Connector	
Rated voltage	[V] 60
Rated current	[A] 4
Contact material	CuSn
Material contact surface M12	Ni/Au
Material contact surface valve connector	Sn
Material of grip body	TPU
Material, knurls	Zinc die-cast, nickel-plated
Degree of protection	IP65 / IP67
Temperature data	
Connector/socket	[°C] -25 ... 90
Valve connectors	[°C] -20 ... 85

Valve connector without wiring, cable type: PVC

Notes:
For information about the cable qualities, see page 298

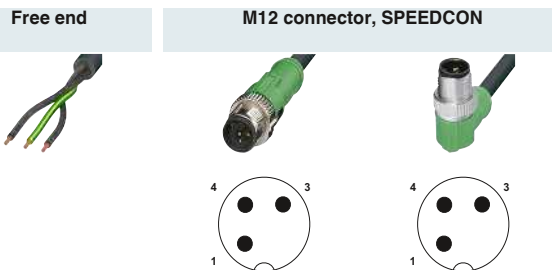

Ordering data

Type	Order No.	Order No.	Order No.	
Type A 	1.5 m	1415920		
	3 m	1415921		
	5 m	1402977		
	10 m	1402978		
	Variable	1400897	Variable 1400895	Variable 1400896
Type B 	Variable	1400909	Variable 1400903	Variable 1400905
	Type BI 	5 m	1439065	
10 m		1438862		
Variable		1400902	Variable 1400900	Variable 1400901
Type C 	5 m	1400814		
	10 m	1400641		
	Variable	1400921	Variable 1400919	Variable 1400920
Type CI 	Variable	1400918	Variable 1400916	Variable 1400917

Information for products with fixed cable length:

Products with fixed cable length are produced with the PVC cable type and are available from stock.

Ordering data for type A, B, BI, C, CI valve connector cables with variable cable:

For a sensor/actuator cable, PVC, black, 4.5 m long, unwired type C valve connector and a 3-pos. straight M12 connector, the ordering data is as follows:

Order No.	Cable type	Length [m] Max. 40 m
1400919	PVC	4.5
Minimum order amount = 25 Increments: 0.2 ... 3 m = 0.1 m > 3 m = 0.5 m		

Cable description	Cable type	Color coding	Pin assignment
PVC - black, 0.5 mm ²	PVC	BK1 1	3
PVC - black, 0.75 mm ²	534	BK2 2	4
PVC - gray, 0.5 mm ²	500	GNYE	5
PUR, halogen-free - black, 0.5 mm ²	PUR		
PUR, halogen-free - black, 1.0 mm ² Type A valve connector only	121		
PUR, halogen-free - yellow, 0.5 mm ²	240		
PUR, halogen-free - gray, 0.5 mm ²	280		
PUR irradiated - orange, 0.5 mm ²	150		
PUR, highly flexible - gray, 0.5 mm ²	800		

Technical data	
Connector	
Rated voltage	[V] 60
Rated current	[A] 4
Contact material	CuSn
Material contact surface M12	Ni/Au
Material contact surface valve connector	Sn
Material of grip body	TPU
Material, knurls	Zinc die-cast, nickel-plated
Degree of protection	IP65 / IP67
Temperature data	
Connector/socket	[°C] -25 ... 90
Valve connectors	[°C] -20 ... 85

Sensor/actuator cabling

Assembled cables

Valve connector, pressure switch with 2 LEDs, cable type: PUR

Notes:

For information about the cable qualities, see page 298

Free end



M12 connector, SPEEDCON

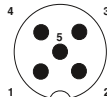

Type AD	Ordering data		Ordering data		Ordering data	
		Order No.		Order No.		Order No.
 	1.5 m	1435085	0.3 m	1435030		
	3 m	1435098	0.6 m	1435043		
	5 m	1435108	1.5 m	1435056		
	10 m	1435111	3 m	1435069		
	Variable	1435124	Variable	1435072		

Information for products with fixed cable length:

Products with fixed cable length are produced with the halogen-free PUR cable type and are available from stock.

Ordering data for type AD valve connector cables with 2 LEDs and variable cable:

For a sensor/actuator cable, PUR, halogen-free, black, 4.5 m long, type AD valve connector with 2 LEDs and a 5-pos. straight M12 connector, the ordering data is as follows:

Order No.	Cable type	Length [m] Max. 40 m
1435072	PUR	4.5
Minimum order amount = 25 Increments: 0.2 ... 3 m = 0.1 m > 3 m = 0.5 m		

Cable description	Cable type	Color coding	Pin assignment
PUR, halogen-free - black, 0.5 mm ²	PUR	BK1 1, BK2 2	1, 2
PUR, halogen-free - yellow, 0.5 mm ²	240	BK3 3, BK2 4	4, 3
PUR, halogen-free - gray, 0.5 mm ²	280	GNYE	5
PUR irradiated - orange, 0.5 mm ²	150		
PUR, highly flexible - gray, 0.5 mm ²	800		
PVC - black, 0.5 mm ²	PVC		
PVC - black, 0.75 mm ²	534		
PVC - gray, 0.5 mm ²	500		

Technical data

Connector	
Rated voltage	[V] 24
Rated current	[A] 4
Contact material	CuSn
Material contact surface M12	Ni/Au
Material contact surface valve connector	Sn
Material of grip body	TPU
Material, knurls	Zinc die-cast, nickel-plated
Degree of protection	IP65 / IP67
Temperature data	
Connector/socket	[°C] -25 ... 90
Valve connectors	[°C] -20 ... 85

Valve connector, pressure switch with 2 LEDs, cable type: PVC

Notes:
For information about the cable qualities, see page 298

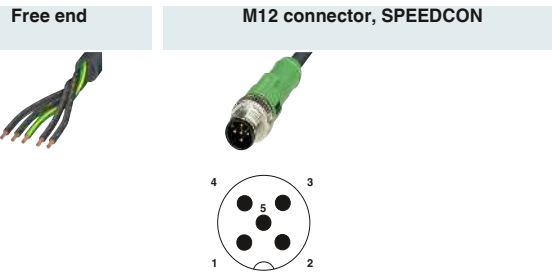

		Ordering data		Ordering data		Ordering data	
Type AD		Order No.	Order No.	Order No.	Order No.	Order No.	Order No.
 	1.5 m	1415945					
	3 m	1415946					
	5 m	1438639					
	10 m	1438671					
	Variable	1435124	Variable	1435072			

Information for products with fixed cable length:

Products with fixed cable length are produced with the PVC cable type and are available from stock.

Ordering data for type AD valve connector cables with 2 LEDs and variable cable:

For a sensor/actuator cable, PVC, black, 4.5 m long, type AD valve connector with 2 LEDs and a 5-pos. straight M12 connector, the ordering data is as follows:

Order No.	Cable type	Length [m] Max. 40 m
1435072	PVC	4.5

Minimum order amount = 25

Increments:
0.2 ... 3 m = 0.1 m
> 3 m = 0.5 m

Cable description	Cable type	Color coding	Pin assignment
PVC - black, 0.5 mm ²	PVC	BK1 1	1
PVC - black, 0.75 mm ²	534	BK2 2	2
PVC - gray, 0.5 mm ²	500	BK3 3	4
		BK2 4	3
		GNYE	5
PUR, halogen-free - black, 0.5 mm ²	PUR		
PUR, halogen-free - yellow, 0.5 mm ²	240		
PUR, halogen-free - gray, 0.5 mm ²	280		
PUR irradiated - orange, 0.5 mm ²	150		
PUR, highly flexible - gray, 0.5 mm ²	800		

Technical data	
Connector	
Rated voltage	[V] 24
Rated current	[A] 4
Contact material	CuSn
Material contact surface M12	Ni/Au
Material contact surface valve connector	Sn
Material of grip body	TPU
Material, knurls	Zinc die-cast, nickel-plated
Degree of protection	IP65 / IP67
Temperature data	
Connector/socket	[°C] -25 ... 90
Valve connectors	[°C] -20 ... 85

Sensor/actuator cabling

Assembled cables

Valve connector, pressure switch without wiring

Free end

M12 connector, SPEEDCON

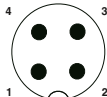

Notes:



For information about the cable qualities, see page 298



Ordering data

Ordering data

Ordering data

Type AD	Order No.	Order No.	Order No.
 	3 m 1438956	Variable 1400899	Variable 1400898

Ordering data for unwired type AD valve connector cables with variable cable:

For a sensor/actuator cable, PUR, halogen-free, black, 4.5 m long, unwired type AD valve connector and a 4-pos. straight M12 connector, the ordering data is as follows:

Cable description	Cable type	Color coding	Pin assignment
PUR, halogen-free - black, 0.5 mm ²	PUR	BK1 1 BK2 2	1 2
PVC - black, 0.5 mm ²	PVC	BK3 3	4
PVC - black, 0.75 mm ²	534	GNYE	5

Order No.	Cable type	Length [m] Max. 40 m
1400898	PUR	4.5
Minimum order amount = 25		
Increments: 0.2 ... 3 m = 0.1 m > 3 m = 0.5 m		

Technical data

		Connector
Rated voltage	[V]	60
Rated current	[A]	4
Contact material		CuSn
Material contact surface M12		Ni/Au
Material contact surface valve connector		Sn
Material of grip body		TPU
Material, knurls		Zinc die-cast, nickel-plated
Degree of protection		IP65 / IP67
Temperature data		
Connector/socket	[°C]	-25 ... 90
Valve connectors	[°C]	-20 ... 85

Double valve connector with Zener diode

Notes:
For information about the cable qualities, see page 298

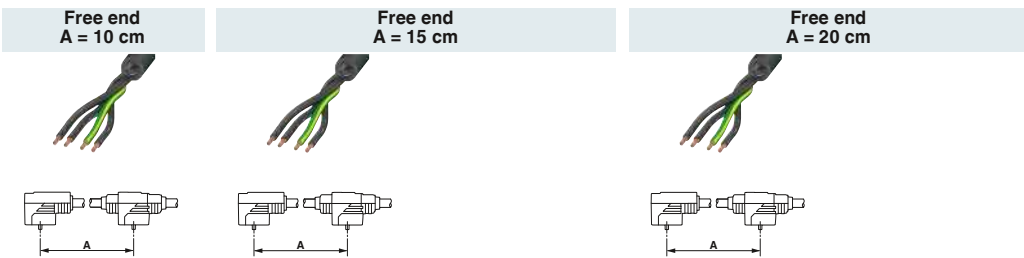

		Ordering data		Ordering data		Ordering data		Ordering data	
		Order No.		Order No.		Order No.		Order No.	
Type A  	1.5 m	1457982	1.5 m	1458020	1.5 m	1458062	1.5 m	1458062	
	3 m	1457995	3 m	1458033	3 m	1458075	3 m	1458075	
	5 m	1458004	5 m	1458046	5 m	1458088	5 m	1458088	
	10 m	1458017	10 m	1458059	10 m	1458091	10 m	1458091	
Type B  	1.5 m	1458169	1.5 m	1458208	1.5 m	1458240	1.5 m	1458240	
	3 m	1458172	3 m	1458211	3 m	1458253	3 m	1458253	
	5 m	1458185	5 m	1458224	5 m	1458266	5 m	1458266	
	10 m	1458198	10 m	1458237	10 m	1458279	10 m	1458279	
Type BI  	1.5 m	1458347	1.5 m	1458389	1.5 m	1458428	1.5 m	1458428	
	3 m	1458350	3 m	1458392	3 m	1458431	3 m	1458431	
	5 m	1458363	5 m	1458402	5 m	1458444	5 m	1458444	
	10 m	1458376	10 m	1458415	10 m	1458457	10 m	1458457	

Technical data

Connector

Rated voltage	[V]	24
Rated current	[A]	4
Material contact surface valve connector		Sn
Degree of protection		IP65 / IP67
Temperature data		
Valve connectors	[°C]	-25 ... 85

Sensor/actuator cabling

Assembled cables

Valve connector, Deutsch DT06 and DT04, without wiring

Notes:
For information about the cable qualities, see page 298

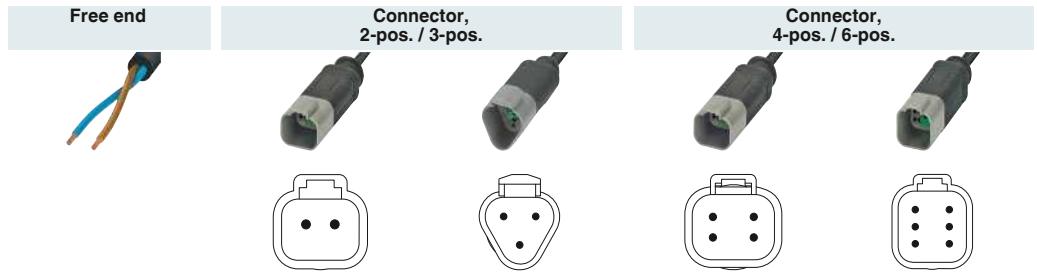

		Ordering data		Ordering data		Ordering data		Ordering data		Ordering data	
Free end		Order No.		Order No.		Order No.		Order No.		Order No.	
						1.5 m	1414999	1.5 m	1415012	1.5 m	1415030
						3 m	1415000	3 m	1415013	3 m	1415031
						5 m	1415001	5 m	1415014	5 m	1415032
						10 m	1415002	10 m	1415015	10 m	1415033
Socket, 2-pos.											
		1.5 m	1410723	0.3 m	1414991						
		3 m	1410724	0.6 m	1414992						
		5 m	1410726	1.5 m	1414993						
		10 m	1410727	3 m	1414994						
Socket, 3-pos.											
		1.5 m	1414995			0.3 m	1415003				
		3 m	1414996			0.6 m	1415004				
		5 m	1414997			1.5 m	1415005				
		10 m	1414998			3 m	1415006				
Socket, 4-pos.											
		1.5 m	1415007					0.3 m	1415016		
		3 m	1415008					0.6 m	1415017		
		5 m	1415010					1.5 m	1415019		
		10 m	1415011					3 m	1415025		
Socket, 6-pos.											
		1.5 m	1415026							0.3 m	1415035
		3 m	1415027							0.6 m	1415036
		5 m	1415028							1.5 m	1415037
		10 m	1415029							3 m	1415038

Technical data

		Connector	
Rated voltage	[V]	48	
Rated current	[A]	8	
Contact material		Cu alloy	
Material contact surface M12		Nickel-plated	
Material of grip body		PA	
Material, knurls		not available	
Degree of protection		IP67	
Temperature data			
Connector/socket	[°C]	-20 ... 85	

**Valve connector,
Deutsch DT06-2S
with LED**

Free end



Notes:

For information about the cable qualities, see page 298

Ordering data

Socket, 2-pos.

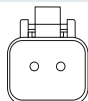

Order No.

1.5 m	1410728
3 m	1410729
5 m	1410730
10 m	1410731

Technical data

		Connector
Rated voltage	[V]	24
Rated current	[A]	8
Contact material		Cu alloy
Material contact surface M12		Nickel-plated
Material of grip body		PA
Material, knurls		not available
Degree of protection		IP67
Temperature data		Connector/socket
Connector/socket	[°C]	-20 ... 85

Assembled cables

Valve connector, Deutsch DT06-2S with freewheeling diode

Notes:
For information about the cable qualities, see page 298

Free end



Socket, 2-pos.

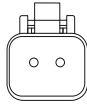

Ordering data

	Order No.
1.5 m	1410732
3 m	1410733
5 m	1410734
10 m	1410735

Technical data

		Connector
Rated voltage	[V]	24
Rated current	[A]	3
Contact material		Cu alloy
Material contact surface M12		Nickel-plated
Material of grip body		PA
Material, knurls		not available
Degree of protection		IP67
Temperature data		
Connector/socket	[°C]	-20 ... 85

Valve connector, Superseal

Free end

Connector

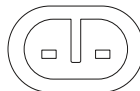

Notes:

For information about the cable qualities, see page 298

Ordering data

Ordering data

Ordering data

Free end	Order No.	Order No.	Order No.
		1.5 m	1410752
		3 m	1410753
		5 m	1410755
		10 m	1410756

Socket, straight

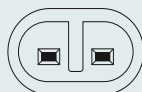

1.5 m	1410748	0.3 m	1410757
3 m	1410749	0.6 m	1410759
5 m	1410750	1.5 m	1410760
10 m	1410751	3 m	1410761

Technical data

Connector

Rated voltage	[V]	24
Rated current	[A]	8
Contact material		CuZn
Material of grip body		PA
Material, knurls		not available
Degree of protection		IP67
Temperature data		
Connector/socket	[°C]	-20 ... 85

Sensor/actuator cabling

Distributors and adapters

M8 Y cable, 3-pos., two cable outlets

M8 Y connector



Notes:

For information about the cable qualities, see page 298

Ordering data

Free end	Order No.
	1.5 m 1458622
	3 m 1458635
	5 m 1458648
	10 m 1458651
M8 socket, straight 	0.3 m 1458664
	0.6 m 1458677
	1.5 m 1458680
	3 m 1458693
M8 socket, angled 	0.3 m 1458703
	0.6 m 1458716
	1.5 m 1458729
	3 m 1458732
M8 socket, angled, with 2 LEDs 	0.3 m 1458745
	0.6 m 1458758
	1.5 m 1458761
	3 m 1458774

Cable description	Cable type	Color coding	Pin assignment, 3-pos.	
			Connector	Socket
PUR, halogen free - black	PUR	BN	1	1
		BK	2 + 4	4
		BU	3	3

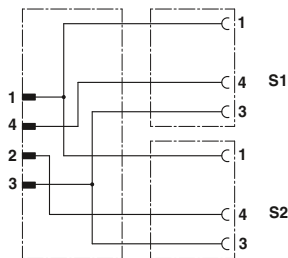

Contact assignment of the M8 connector and the M8 sockets

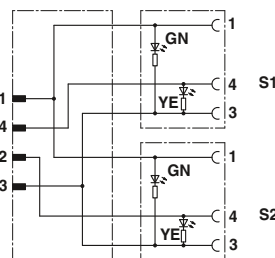

Contact assignment of the M8 connector and the M8 sockets, with LEDs

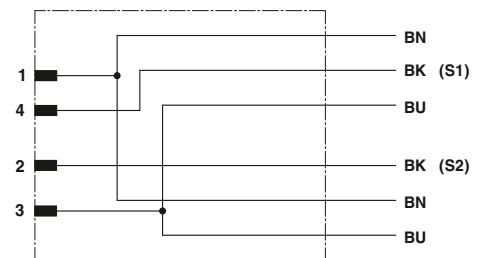

Contact assignment of the M8 Y connector with LEDs

		Technical data	
		Y-M8	Y-M8 with LEDs
Rated voltage	[V]	30	24
Rated current	[A]	4	4
Contact material		CuSn	CuSn
Contact surface material		Ni/Au	Ni/Au
Material of grip body		TPU, hardly inflammable, self-extinguishing	TPU, hardly inflammable, self-extinguishing
Material, knurls		Zinc die-cast, nickel-plated	Zinc die-cast, nickel-plated
M8 circular connector according to:		IEC 61076-2-104	IEC 61076-2-104
Degree of protection		IP65 / IP67 / IP68	IP65 / IP67 / IP68
Temperature data			
Connector/socket	[°C]	-25 ... 90	-25 ... 90

M12 Y-cable, 4-pos., one cable outlet

Notes:
 For information about the cable qualities, see page 298
 Further combinations on request.

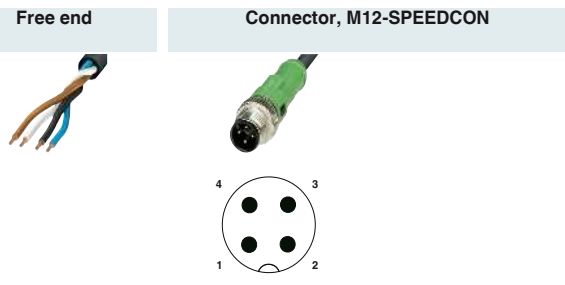

Y-connector with 2 x M12-SPEEDCON socket	Ordering data		Ordering data		Ordering data	
		Order No.		Order No.		Order No.
	1.5 m	1436165	0.3 m	1436204		
	3 m	1436178	0.6 m	1436217		
	5 m	1436181	1.5 m	1436220		
	10 m	1436194	3 m	1436233		

Cable description	Cable type	Suitable for:	Color coding	Pin assignment		
				M12 4-pos.	S1	M12-Y S2
PUR, halogen-free - black	PUR	M12 4-pos.				
			BN	1	1	1
			BK	4	4	-
			WH	2	-	4
			BU	3	3	3

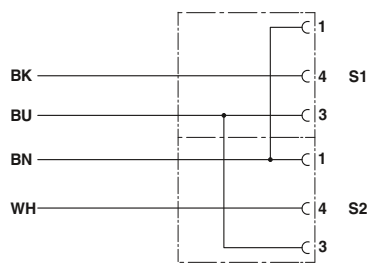

Contact assignment: Y-distributor to free end

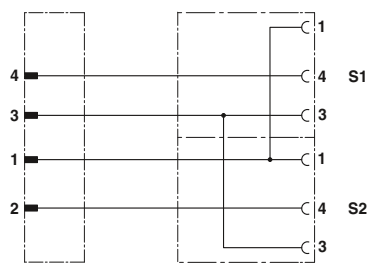

Contact assignment: Y-distributor to M12-SPEEDCON

Technical data	
Y-M12	
Rated voltage	[V] 60
Rated current	[A] 4
Contact material	CuSn
Contact surface material	Ni/Au
Contact carrier material	TPU GF
M12 circular connector according to:	IEC 61076-2-101
Degree of protection	IP65 / IP67
Temperature data	
Connector/socket	[°C] -25 ... 90

Sensor/actuator cabling

Distributors and adapters

M12 Y-cable, 4-pos., two cable outlets

Notes:
For information about the cable qualities, see page 298

M12 Y connector

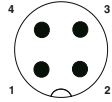

M12 Y connector, SPEEDCON

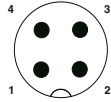

Free end	Ordering data		Ordering data		Ordering data
		Order No.		Order No.	Order No.
	1.5 m	1669686	1.5 m	1524200	
	3 m	1669699	3 m	1524213	
	5 m	1669754	5 m	1524226	
	10 m	1694473	10 m	1524239	
	Variable	1697357	Variable	1524242	
M8 socket, straight 	0.3 m	1671331			
	0.6 m	1671344			
	1.5 m	1671357			
	3 m	1671360			
	Variable	1697399	Variable	1541885	
M8 socket, angled 	0.3 m	1671373			
	0.6 m	1671386			
	1.5 m	1671399			
	3 m	1671409			
	Variable	1697409	Variable	1541898	
M8 socket, angled, with 2 LEDs 	0.3 m	1671412			
	0.6 m	1671425			
	1.5 m	1671438			
	3 m	1671441			
	Variable	1697412	Variable	1541908	
M12 socket, straight (2nd column M12-SPEEDCON socket) 	Variable	1699766	Variable	1542198	
	Variable	1506419	Variable	1542004	
M12 socket, angled (2nd column M12-SPEEDCON socket) 	0.3 m	1668959			
	0.6 m	1668962			
	1.5 m	1668975			
	3 m	1668988			
	Variable	1697360	Variable	1542169	
M12 socket, straight, pin 2 - 4 bridged (2nd column M12-SPEEDCON socket) 	0.3 m	1668991			
	0.6 m	1669000			
	1.5 m	1669013			
	3 m	1669026			
	Variable	1697373	Variable	1542172	
M12 socket, angled, with LED, pins 2 - 4 bridged (2nd column socket M12-SPEEDCON socket) 	0.3 m	1669039			
	0.6 m	1669042			
	1.5 m	1669055			
	3 m	1669068			
	Variable	1697386	Variable	1542185	

Information for products with fixed cable length:

Products with fixed cable length are produced with the halogen-free **PUR** cable type and are available from stock.

Ordering data for products with variable cable:

For a sensor/actuator cable, PUR, halogen-free, black, 4.5 m long, with a straight 4-pos. M12 Y-connector and two straight M12 sockets, the ordering data is as follows:

Order No.	Cable type	Length [m] Max. 40 m
1699766	PUR	4.5
Minimum order amount = 25		
Increments: 0.2 ... 3 m = 0.1 m > 3 m = 0.5 m		

Cable description	Cable type	Suitable for:
PUR, halogen-free - black E221474	PUR	M8/M12
PUR, halogen-free - gray E221474	280	M12
TPE-U highly flexible - gray E221474	800	M8/M12
PUR irradiated - orange E221474	150	M12
PVC - black E221474	PVC	M8/M12
PVC - gray E221474	500	M8/M12
PVC - yellow E221474	540	M12
PVC 105° - yellow E221474	542	M12

Color coding	Pin assignment, 3-pos.	
	Connector	Socket
BN	1	1
BK	2 + 4	4
BU	3	3

With a combination of M12 and M8 connectors, the limiting M8 value applies to the rated voltage.

	Technical data		Technical data	
	Y-M8	Y-M8 with LEDs	Y-M12	Y-M12 with LEDs
Rated voltage [V]	60	24	250	24
Rated current [A]	4	4	4	4
Contact material	CuSn	CuSn	CuSn	CuSn
Contact surface material	Ni/Au	Ni/Au	Ni/Au	Ni/Au
Material of grip body	TPU, hardly inflammable, self-extinguishing	TPU, hardly inflammable, self-extinguishing	TPU, hardly inflammable, self-extinguishing	TPU, hardly inflammable, self-extinguishing
M8 circular connector according to:	IEC 61076-2-104	IEC 61076-2-104	-	-
M12 circular connector according to:	IEC 61076-2-101	IEC 61076-2-101	IEC 61076-2-101	IEC 61076-2-101
Degree of protection	IP65 / IP67 / IP68	IP65 / IP67 / IP68	IP65 / IP67 / IP68	IP65 / IP67 / IP68
Temperature data				
Connector/socket [°C]	-25 ... 90	-25 ... 90	-25 ... 90	-25 ... 90

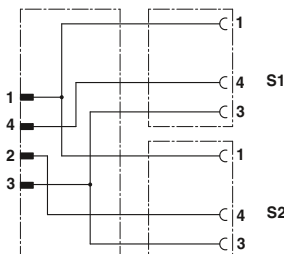

Contact assignment of the M12 connector and the M8/M12 sockets

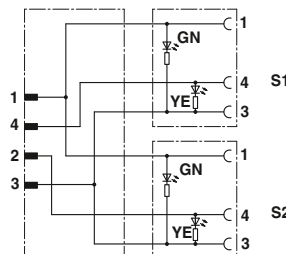

Contact assignment of the M12 connector and the M8 sockets, with LEDs

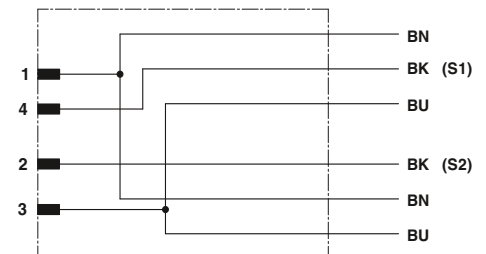

Contact assignment of the M12 Y connector with LEDs

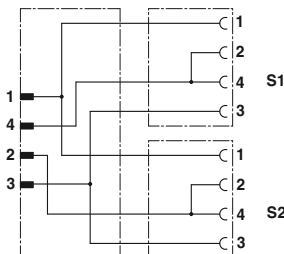

Contact assignment of the M12 connector and the M12 socket, bridged

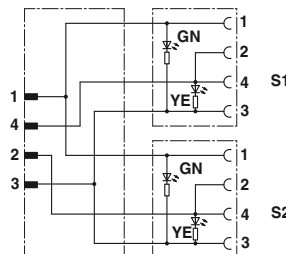

Contact assignment of the M12 connector and the M12 socket, with LEDs, bridged

Sensor/actuator cabling

Distributors and adapters

M8/M12 Y-distributors, M12 T-distributors



3-pos.



3+PE-pos.

ERC

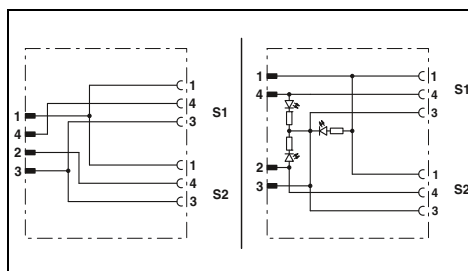

ERC

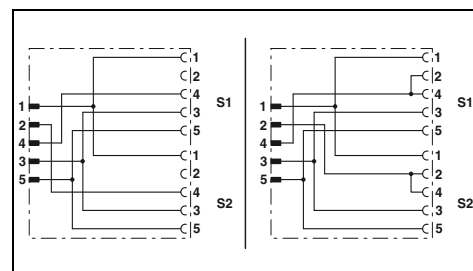

Technical data

Without LED With 3 LEDs

General data	IEC 61076-2-104	
M8 circular connector according to:	IEC 61076-2-101	
M12 circular connector according to:	3	
Pollution degree	IP65/IP67	
Degree of protection	IP65/IP67	
Electrical data		
Rated voltage	60 V	24 V
Rated current	4 A	
Material data		
Contact material	CuZn	
Contact surface material	Ni/Au	
Inflammability class according to UL 94	HB	
Temperature data		
Connector/socket	-25 ... 90	

Ordering data

Order No.	Pcs. / Pkt.	Order No.	Pcs. / Pkt.
Without LED		With 3 LEDs	

1696183 5
1683471 5

1523984 5

1403627 5

Technical data

Not bridged Pins 2 and 4 bridged

General data	IEC 61076-2-101	
M8 circular connector according to:	IEC 61076-2-101	
M12 circular connector according to:	3	
Pollution degree	IP65/IP67	
Degree of protection	IP65/IP67	
Electrical data		
Rated voltage	60 V	24 V
Rated current	4 A	
Material data		
Contact material	CuZn	
Contact surface material	Ni/Au	
Inflammability class according to UL 94	HB	
Temperature data		
Connector/socket	-25 ... 90	

Ordering data

Order No.	Pcs. / Pkt.	Order No.	Pcs. / Pkt.
Not bridged		Pins 2 and 4 bridged	

1683455 5 1683413 5
1511789 5 1514016 5

1523971 5 1523968 5

1519723 1

General data	
M8 circular connector according to:	
M12 circular connector according to:	
Pollution degree	
Degree of protection	
Electrical data	
Rated voltage	
Rated current	
Material data	
Contact material	
Contact surface material	
Inflammability class according to UL 94	
Temperature data	
Connector/socket	[°C]

Description	Center distance
M8/M12 Y-distributor	
M8 connector to 2x M8 sockets	12 mm
M12 connector to 2x M8 sockets	12 mm
M8/M12 SPEEDCON Y-distributor	
M12 connector to 2x M8 sockets	12 mm
M12 Y-distributor	
M12 connector to 2x M12 sockets	18 mm
M12 connector to 2x M12 sockets	21 mm
M12 SPEEDCON Y-distributor	
M12 connector to 2x M12 sockets	18 mm
M12 connector to 2x M12 sockets	21 mm
T-distributor	
M12 connector to 2x M12 sockets	

**M8/M12 Y-distributors, parallel,
M12 T-distributors, parallel**



3-, 5-, 8-pos.



5-, 8-pos., shielded

ERC

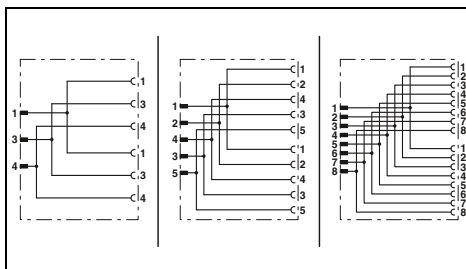

ERC

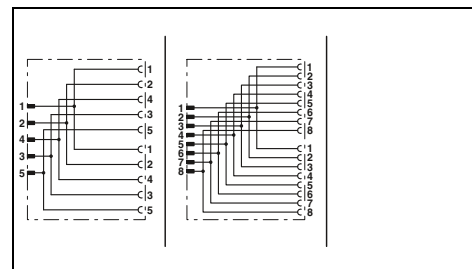

Technical data

	3-pos.	5-pos.	8-pos.
General data			
M8 circular connector according to:	IEC 61076-2-104		
M12 circular connector according to:		IEC 61076-2-101	
Pollution degree		3	
Degree of protection		IP65/IP67	
Electrical data			
Rated voltage		60 V	30 V
Rated current		4 A	2 A
Material data			
Contact material		CuZn	
Contact surface material		Ni/Au	
Inflammability class according to UL 94		HB	
Temperature data			
Connector/socket		-25 ... 90	

Technical data

	5-pos.	8-pos.
General data		
M12 circular connector according to:		IEC 61076-2-101
Pollution degree		3
Degree of protection		IP65/IP67
Electrical data		
Rated voltage	60 V	30 V
Rated current	4 A	2 A
Material data		
Contact material		CuZn
Contact surface material		Ni/Au
Inflammability class according to UL 94		HB
Temperature data		
Connector/socket		-25 ... 90

Ordering data

Description	Center distance	3-pos.		5-pos.		8-pos.	
		Order No.	Pcs. / Pkt.	Order No.	Pcs. / Pkt.	Order No.	Pcs. / Pkt.
M8/M12 Y-distributor							
M8 connector to 2x M8 sockets	12 mm	1696222	5				
M12 connector to 2x M8 sockets	12 mm	1683549	5				
M12 Y-distributor							
M12 connector to 2x M12 sockets	18 mm			1683468	5		
M12 connector to 2x M12 sockets	21 mm			1514029	5		
M12 SPEEDCON Y-distributor							
M12 connector to 2x M12 sockets	18 mm			1546068	5		
M12 connector to 2x M12 sockets	21 mm					1454972	5
M12 connector to M12 connector/M12 socket	21 mm						
M12 socket to 2x M12 connectors	21 mm						
M12 socket to M12 connector/M12 socket	21 mm						
T-distributor							
Green				1541186	1		

Ordering data

Description	Center distance	5-pos.		8-pos.	
		Order No.	Pcs. / Pkt.	Order No.	Pcs. / Pkt.
5-pos.					
8-pos.					
M12 connector to 2x M12 sockets	18 mm	1419920	5	1454969	5
M12 connector to 2x M12 sockets	21 mm	1438079	5		
M12 socket to 2x M12 connectors	21 mm	1419946	5		
M12 socket to M12 connector/M12 socket	21 mm	1419933	5		



3-, 4-pos.

ERC

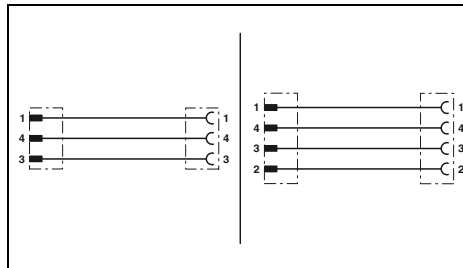

Technical data

	3-pos.		4-pos.	
	General data			
M8 circular connector according to:	IEC 61076-2-104			
M12 circular connector according to:	IEC 61076-2-101			
Pollution degree	3			
Degree of protection	IP65/IP67			
Electrical data				
Rated voltage	60 V		30 V	
Rated current	4 A			
Material data				
Contact material	CuSn			
Contact surface material	Ni/Au			
Inflammability class according to UL 94	HB			
Temperature data				
Connector/socket	[°C]		-25 ... 90	

Ordering data

Description	3-pos.		4-pos.	
	Order No.	Pcs. / Pkt.	Order No.	Pcs. / Pkt.
Adapter				
M8 connector to M12 socket	1519749	5	1519736	5
M12 connector to M8 socket	1519752	5	1519765	5
M12 connector to M8 snap-in socket	1519781	5	1519778	5

7/8" T-distributors, parallel



3-pos.



5-pos.

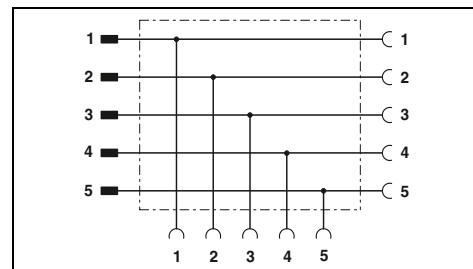
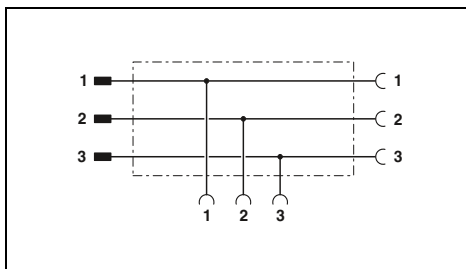

Technical data

General data	
Pollution degree	3
Degree of protection	IP65/IP67
Electrical data	
Rated voltage	600 V
Rated current	13 A (at 25 °C)
Material data	
Contact material	CuZn
Contact surface material	AU
Inflammability class according to UL 94	HB
Temperature data	
Connector/socket	[°C] -40 ... 80

Ordering data

Description	
7/8" T-distributor, 7/8"-16UNF socket to 7/8"-16UNF socket and 7/8"-16UNF connector	
3-pos.	
5-pos.	

Type	Order No.	Pcs. / Pkt.
SAC-3P-MINT/2XMIN VP	1412393	1

Technical data

General data	
Pollution degree	3
Degree of protection	IP65/IP67
Electrical data	
Rated voltage	250 V
Rated current	10 A (at 25 °C)
Material data	
Contact material	CuZn
Contact surface material	AU
Inflammability class according to UL 94	HB
Temperature data	
Connector/socket	-40 ... 80

Ordering data

Type	Order No.	Pcs. / Pkt.
SAC-5P-MINT/2XMIN VP	1543977	1

Sensor/actuator cabling

Distributors and adapters

Valve connector adapter with M12 SPEEDCON connector



Valve connector type A



Valve connector, AD design, Pressure switch

ERIC (R)

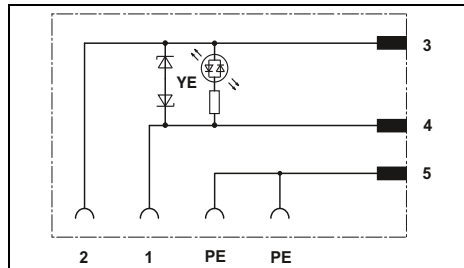

Technical data

ERIC (R)

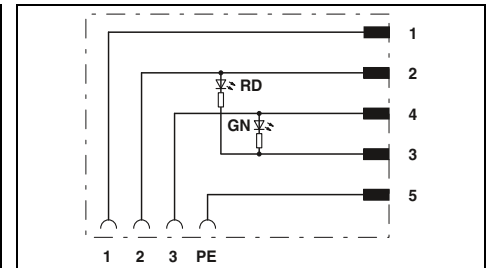

Technical data

General data	
M12 circular connector according to:	IEC 61076-2-101
Valve connector according to:	EN 175301-803
Electrical data in acc. with IEC 61076-2-101	
Rated voltage	24 V AC/DC
Rated current	4 A
Cut-off peak	≤ 55 V
Status display	Yellow LED
Material data	
Contact material valve connectors	CuSn
Contact surface material valve connectors	Sn
Contact material M12 connector	CuSn
Contact surface material M12 connector	Ni/Au
Material housing valve connector	TPU
Inflammability class according to UL 94	HB
Temperature data	
Ambient temperature (operation)	-25 °C ... 85 °C (valve connector)

General data	
M12 circular connector according to:	IEC 61076-2-101
Valve connector according to:	EN 175301-803
Electrical data in acc. with IEC 61076-2-101	
Rated voltage	24 V AC/DC
Rated current	4 A
Cut-off peak	-
Status display	2 LEDs
Material data	
Contact material valve connectors	CuSn
Contact surface material valve connectors	Sn
Contact material M12 connector	CuSn
Contact surface material M12 connector	Ni/Au
Material housing valve connector	TPU
Inflammability class according to UL 94	HB
Temperature data	
Ambient temperature (operation)	-25 °C ... 85 °C (valve connector)

Ordering data

Ordering data

Description	Type	Order No.	Pcs. / Pkt.
Valve connector type A , PE bridged, 18 mm contact spacing			
- Vertical M12 SPEEDCON connector	SAC-3P-MS/A-1L-Z SCO	1458525	1
- Horizontal M12 SPEEDCON connector	SAC-3P-MR/A-1L-Z SCO	1458538	1
Valve connector type AD , 18 mm contact spacing			
- Vertical M12 SPEEDCON connector			
- Horizontal M12 SPEEDCON connector			
Valve connector type B , 10 mm contact spacing			
- Vertical M12 SPEEDCON connector			
- Horizontal M12 SPEEDCON connector			
Valve connector type BI , 11 mm contact spacing			
- Vertical M12 SPEEDCON connector			
- Horizontal M12 SPEEDCON connector			
DESINA valve connector type A , 18 mm contact spacing			
- Vertical M12 SPEEDCON connector			

Type	Order No.	Pcs. / Pkt.
SAC-3P-MS/A-1L-Z SCO	1458525	1
SAC-3P-MR/A-1L-Z SCO	1458538	1
SAC-5P-MS/AD-2L SCO	1458596	1
SAC-5P-MR/AD-2L SCO	1458606	1

Type	Order No.	Pcs. / Pkt.
SAC-5P-MS/AD-2L SCO	1458596	1
SAC-5P-MR/AD-2L SCO	1458606	1



Valve connector type B



Valve connector type BI



DESINA valve connector type A

ERC (R)

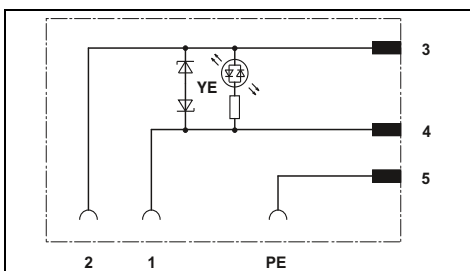

Technical data

IEC 61076-2-101
EN 175301-803

24 V AC/DC
4 A
≤ 55 V
Yellow LED

CuSn
Sn
CuSn
Ni/Au
TPU
HB

-25 °C ... 85 °C (valve connector)

Ordering data

Type	Order No.	Pcs. / Pkt.
SAC-3P-MS/B-1L-Z SCO	1458541	1
SAC-3P-MR/B-1L-Z SCO	1458554	1

ERC (R)

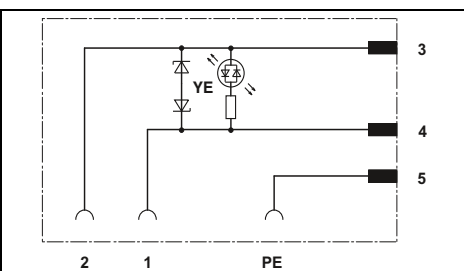

Technical data

IEC 61076-2-101

24 V AC/DC
4 A
≤ 55 V
Yellow LED

CuSn
Sn
CuSn
Ni/Au
TPU
HB

-25 °C ... 85 °C (valve connector)

Ordering data

Type	Order No.	Pcs. / Pkt.
SAC-3P-MS/BI-1L-Z SCO	1458567	1
SAC-3P-MR/BI-1L-Z SCO	1458570	1

ERC (R)

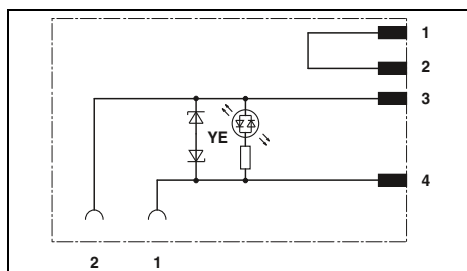

Technical data

IEC 61076-2-101
EN 175301-803

24 V AC/DC
4 A
≤ 55 V
Yellow LED

CuSn
Sn
CuSn
Ni/Au
TPU
HB

-25 °C ... 85 °C (valve connector)

Ordering data

Type	Order No.	Pcs. / Pkt.
SAC-4P-MS/A-1L-Z D SCO	1458583	1

Double valve connector adapter with M12-SPEEDCON connector, type A



Type A

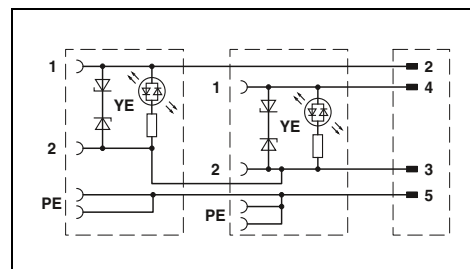

General data	
M12 circular connector according to:	IEC 61076-2-101
Valve connector according to:	EN 175301-803
Degree of protection	IP65/IP67
Electrical data	
Rated voltage	24 V AC/DC
Rated current	4 A
Material data	
Material contact M12	CuSn
Material contact valve connector	CuSn
Material contact surface M12	Ni/Au
Material contact surface valve connector	Sn
Material housing valve connector	TPU
Temperature data	
Valve connectors	-25 ... 85 [°C]

Technical data

Ordering data		
Type	Order No.	Pcs. / Pkt.
SAC-MS/0,1-116/2XA-1L-Z SCO	1458101	1
SAC-MR/0,1-116/2XA-1L-Z SCO	1458130	1
SAC-MS/0,15-116/2XA-1L-Z SCO	1458114	1
SAC-MR/0,15-116/2XA-1L-Z SCO	1458143	1
SAC-MS/0,2-116/2XA-1L-Z SCO	1458127	1
SAC-MR/0,2-116/2XA-1L-Z SCO	1458156	1

Description	
Double valve connector , connector distance: 10 cm, valve connector leading to valve connector adapter with:	
- Vertical M12 SPEEDCON connector	
- Horizontal M12 SPEEDCON connector	
Double valve connector , connector distance: 15 cm, valve connector leading to valve connector adapter with:	
- Vertical M12 SPEEDCON connector	
- Horizontal M12 SPEEDCON connector	
Double valve connector , connector distance: 20 cm, valve connector leading to valve connector adapter with:	
- Vertical M12 SPEEDCON connector	
- Horizontal M12 SPEEDCON connector	

Ordering data

Description	
Double valve connector , connector distance: 10 cm, valve connector leading to valve connector adapter with:	
- Vertical M12 SPEEDCON connector	
- Horizontal M12 SPEEDCON connector	
Double valve connector , connector distance: 15 cm, valve connector leading to valve connector adapter with:	
- Vertical M12 SPEEDCON connector	
- Horizontal M12 SPEEDCON connector	
Double valve connector , connector distance: 20 cm, valve connector leading to valve connector adapter with:	
- Vertical M12 SPEEDCON connector	
- Horizontal M12 SPEEDCON connector	

Double valve connector adapter with M12-SPEEDCON connector, type B and BI



Type B



Type BI

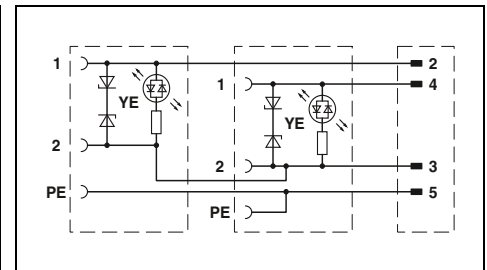
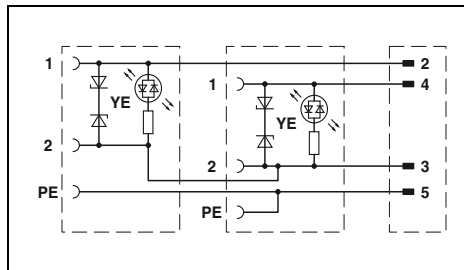

Technical data

Technical data

General data	
M12 circular connector according to:	IEC 61076-2-101
Valve connector according to:	EN 175301-803
Degree of protection	IP65/IP67
Electrical data	
Rated voltage	24 V AC/DC
Rated current	4 A
Material data	
Material contact M12	CuSn
Material contact valve connector	CuSn
Material contact surface M12	Ni/Au
Material contact surface valve connector	Sn
Material housing valve connector	TPU
Temperature data	
Valve connectors	-25 ... 85 [°C]

Technical data	
IEC 61076-2-101	
EN 175301-803	
IP65/IP67	
Electrical data	
24 V AC/DC	
4 A	
Material data	
CuSn	
CuSn	
Ni/Au	
Sn	
TPU	
Temperature data	
-25 ... 85	

Technical data	
IEC 61076-2-101	
-	
IP65/IP67	
Electrical data	
24 V AC/DC	
4 A	
Material data	
CuSn	
CuSn	
Ni/Au	
Sn	
TPU	
Temperature data	
-25 ... 85	

Ordering data

Ordering data

Description
Double valve connector , connector distance: 10 cm, valve connector leading to valve connector adapter with: - Vertical M12 SPEEDCON connector - Horizontal M12 SPEEDCON connector
Double valve connector , connector distance: 15 cm, valve connector leading to valve connector adapter with: - Vertical M12 SPEEDCON connector - Horizontal M12 SPEEDCON connector
Double valve connector , connector distance: 20 cm, valve connector leading to valve connector adapter with: - Vertical M12 SPEEDCON connector - Horizontal M12 SPEEDCON connector

Type	Order No.	Pcs. / Pkt.
SAC-MS/0,1-116/2XB-1L-Z SCO	1458282	1
SAC-MR/0,1-116/2XB-1L-Z SCO	1458318	1
SAC-MS/0,15-116/2XB-1L-Z SCO	1458295	1
SAC-MR/0,15-116/2XB-1L-Z SCO	1458321	1
SAC-MS/0,2-116/2XB-1L-Z SCO	1458305	1
SAC-MR/0,2-116/2XB-1L-Z SCO	1458334	1

Type	Order No.	Pcs. / Pkt.
SAC-MS/0,1-116/2XBI-1L-Z SCO	1458460	1
SAC-MR/0,1-116/2XBI-1L-Z SCO	1458499	1
SAC-MS/0,15-116/2XBI-1L-Z SCO	1458473	1
SAC-MR/0,15-116/2XBI-1L-Z SCO	1458509	1
SAC-MS/0,2-116/2XBI-1L-Z SCO	1458486	1
SAC-MR/0,2-116/2XBI-1L-Z SCO	1458512	1

Distributor boxes

M8 distributor with metal thread



With a master cable



M12 plug-in connection, vertical



M12 plug-in connection, vertical

General data	
Degree of protection in acc. with IEC 60529/EN 60529	
M8 circular connector according to:	
M12 circular connector according to:	
Electrical data	
Rated current for each I/O signal	[A]
Rated current per slot	[A]
Rated current, total	[A]
Dimensions	
Width x height	[mm]
Length (4 / 6 / 8 / 10 slots)	[mm]
Temperature data	
Distributor box	[°C]
Master cable, fixed installation	[°C]
Master cable, flexible installation	[°C]

Technical data		Technical data		Technical data	
IP65 / IP67		IP65 / IP67		IP65 / IP67	
IEC 61076-2-104		IEC 61076-2-104		IEC 61076-2-104	
-		IEC 61076-2-101		IEC 61076-2-101	
2	2	2	2	1.5	1.5
2	2	2	2	1.5	1.5
6	4	4	4	1.5	1.5
30 x 22	30 x 27	30 x 27	30 x 27	30 x 27	30 x 27
102 / 122 / 141 / 161	93 / 113 / - / -	93 / 113 / - / -	93 / 113 / - / -	- / - / 133 / 152	- / - / 133 / 152
-30 ... 80	-30 ... 80	-30 ... 80	-30 ... 80	-30 ... 80	-30 ... 80
-40 ... 90	-	-	-	-	-
-5 ... 80	-	-	-	-	-

Status indication	Signal type	Rated voltage	Slots	Cable length
With LED	PNP	24 V DC	4	-
With LED	PNP	24 V DC	4	5 m
With LED	PNP	24 V DC	4	10 m
With LED	PNP	24 V DC	4	Variable
With LED	PNP	24 V DC	6	-
With LED	PNP	24 V DC	6	5 m
With LED	PNP	24 V DC	6	10 m
With LED	PNP	24 V DC	6	Variable
With LED	PNP	24 V DC	8	-
With LED	PNP	24 V DC	8	5 m
With LED	PNP	24 V DC	8	10 m
With LED	PNP	24 V DC	8	Variable
With LED	PNP	24 V DC	10	-
With LED	PNP	24 V DC	10	5 m
With LED	PNP	24 V DC	10	10 m
With LED	PNP	24 V DC	10	Variable

Ordering data		Ordering data		Ordering data	
Single occupancy	Double occupancy	Single occupancy	Double occupancy	Single occupancy	Double occupancy
-	-	1516234	-	-	-
1516014	-	-	-	-	-
1516027	-	-	-	-	-
1516137	-	-	-	-	-
-	-	1516247	-	-	-
1516030	-	-	-	-	-
1516043	-	-	-	-	-
1516140	-	-	-	-	-
-	-	-	-	1434840	-
1516056	1516111	-	-	-	-
1516069	1516124	-	-	-	-
1516153	1516179	-	-	-	-
-	-	-	-	1434853	-
1516072	-	-	-	-	-
1516085	-	-	-	-	-
1516166	-	-	-	-	-

For accessories, refer to page
 For master cable rings, see page
 For master cable data, see page

Notes:	Notes:	Notes:
291	291	291
312	285	285

Ordering example for products with variable master cable:

For a distributor with 4 single-occupancy slots and a master cable length of 34.5 m, the ordering data is as follows:

Order No.	Length [m]
1516137	34.5
Increment: 0.5 m; Length min.: 0.5 m Length max.: 50 m	

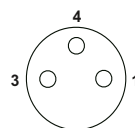

Pin assignment M8 socket, 3-pos.

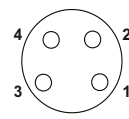

Pin assignment M8 socket, 4-pos.

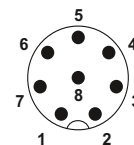

Connector pin assignment for M12 plug-in connection, 8-pos.

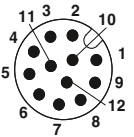

Pin assignment for M12 plug-in connection, 12-pos.



M16 plug-in connection, vertical



Spring connection, horizontal



Plug-in screw connection, horizontal



Header for plug-in screw connection



Connector hood, with a master cable



Connector hood, without master cable

Phoenix Contact		Phoenix Contact		Phoenix Contact		Phoenix Contact		Phoenix Contact		Phoenix Contact	
Technical data		Technical data		Technical data		Technical data		Technical data		Technical data	
IP65 / IP67 IEC 61076-2-104 -		IP65 / IP67 IEC 61076-2-104 -		IP65 / IP67 IEC 61076-2-104 -		IP65 / IP67 IEC 61076-2-104 -		IP65 / IP67 - -		IP65 / IP67 - -	
2 2 6		2 2 6		2 2 8		2 2 8		2 - 8		2 - -	
30 x 26 93 / 113 / 132 / 152		30 x 44 122 / 142 / 176 / 196		30 x 44 122 / 142 / 176 / 196		30 x 20 122 / 142 / 176 / 196		30 x 24 - / - / - / -		30 x 24 - / - / - / -	
-30 ... 80 -		-30 ... 80 -		-30 ... 80 -		-30 ... 80 -		-30 ... 80 -40 ... 90 -5 ... 80		-30 ... 80 -	
Ordering data		Ordering data		Ordering data		Ordering data		Ordering data		Ordering data	
Single occupancy	Double occupancy	Single occupancy	Double occupancy	Single occupancy	Double occupancy	Single occupancy	Double occupancy	Single occupancy	Double occupancy	Single occupancy	Double occupancy
1516182	-	1503386	-	1503412	-	1516250	-	-	-	1521229	-
-	-	-	-	-	-	-	-	1516292	-	-	-
-	-	-	-	-	-	-	-	1516302	-	-	-
-	-	-	-	-	-	-	-	1516373	-	-	-
1516195	-	1503399	-	1503425	-	1516263	-	-	-	1521216	-
-	-	-	-	-	-	-	-	1516315	-	-	-
-	-	-	-	-	-	-	-	1516328	-	-	-
-	-	-	-	-	-	-	-	1516386	-	-	-
1516205	-	1511747	1503454	1511750	1503467	1516276	-	-	-	1516425	-
-	-	-	-	-	-	-	-	1516331	-	-	-
-	-	-	-	-	-	-	-	1516344	-	-	-
-	-	-	-	-	-	-	-	1516399	-	-	-
1516218	-	1503409	-	1503438	-	1516289	-	-	-	1516412	-
-	-	-	-	-	-	-	-	1516357	-	-	-
-	-	-	-	-	-	-	-	1516360	-	-	-
-	-	-	-	-	-	-	-	1516409	-	-	-
Notes:		Notes:		Notes:		Notes:		Notes:		Notes:	
290 285		290 285		290 285		290		290		312	

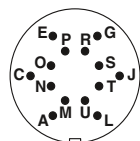

Connector pin assignment for M16 plug-in connection, 14-pos.

Sensor/actuator cabling

Distributor boxes

M12 distributor with plastic thread, middle duty



With a master cable



Spring connection, horizontal



Push-in spring connection, horizontal

General data	
Degree of protection in acc. with IEC 60529/EN 60529	
M12 circular connector according to:	
Electrical data	
Rated current for each I/O signal	[A]
Rated current per slot	[A]
Rated current, total	[A]
Dimensions	
Width x height	[mm]
Length (4 / 6 / 8 / 10 slots)	[mm]
Temperature data	
Distributor box	[°C]
Master cable, fixed installation	[°C]
Master cable, flexible installation	[°C]

Technical data	Technical data	Technical data
IP65 / IP67	IP65 / IP67	IP65 / IP67
IEC 61076-2-101	IEC 61076-2-101	IEC 61076-2-101
2	2	2
4	4	4
12	12	-
54 x 23	54 x 42	54 x 43
117 / 123 / 149 / -	117 / 123 / 149 / -	117 / 123 / 149 / -
-25 ... 80	-25 ... 80	-25 ... 80
-40 ... 90	-	-
-5 ... 80	-	-

Status indication	Signal type	Rated voltage	Slots	Cable length
Without LED	Universal	120 V	4	-
Without LED	Universal	120 V	4	5 m
Without LED	Universal	120 V	4	10 m
Without LED	Universal	120 V	6	-
Without LED	Universal	120 V	6	5 m
Without LED	Universal	120 V	6	10 m
Without LED	Universal	120 V	8	-
Without LED	Universal	120 V	8	5 m
Without LED	Universal	120 V	8	10 m
With LED	PNP	24 V DC	4	-
With LED	PNP	24 V DC	4	5 m
With LED	PNP	24 V DC	4	10 m
With LED	PNP	24 V DC	4	Variable
With LED	PNP	24 V DC	6	-
With LED	PNP	24 V DC	6	5 m
With LED	PNP	24 V DC	6	10 m
With LED	PNP	24 V DC	6	Variable
With LED	PNP	24 V DC	8	-
With LED	PNP	24 V DC	8	5 m
With LED	PNP	24 V DC	8	10 m
With LED	PNP	24 V DC	8	Variable
With LED	NPN	24 V DC	4	5 m
With LED	NPN	24 V DC	4	10 m
With LED	NPN	24 V DC	6	5 m
With LED	NPN	24 V DC	6	10 m
With LED	NPN	24 V DC	8	5 m
With LED	NPN	24 V DC	8	10 m

Ordering data		Ordering data		Ordering data	
Single occupancy	Double occupancy	Single occupancy	Double occupancy	Single occupancy	Double occupancy
-	-	1452929	1452932	-	-
1452398	1452424	-	-	-	-
1452408	1452437	-	-	-	-
-	-	1452945	1452958	-	-
1452453	1452482	-	-	-	-
1452466	1452495	-	-	-	-
-	-	1452961	1452974	-	-
1452518	1452547	-	-	-	-
1452521	1452550	-	-	-	-
-	-	1452987	1452990	-	1412058
1452576	1452602	-	-	-	-
1452589	1452615	-	-	-	-
1401376	1401419	-	-	-	-
-	-	1453009	1453012	-	1412059
1452631	1452660	-	-	-	-
1452644	1452673	-	-	-	-
1401379	1401380	-	-	-	-
-	-	1453025	1453038	-	1412060
1452699	1452725	-	-	-	-
1452709	1452738	-	-	-	-
1401382	1401383	-	-	-	-
1405678	1405713	-	-	-	-
1405687	1405732	-	-	-	-
1405733	1405735	-	-	-	-
1405734	1405736	-	-	-	-
1405737	1405739	-	-	-	-
1405738	1405740	-	-	-	-

For accessories, refer to page
 For master cable rings, see page
 For master cable data, see page

Notes:	Notes:	Notes:
292	292	292
313	285	285

Ordering example for products with variable master cable:

For a distributor with 4 single-occupancy slots and a master cable length of 34.5 m, the ordering data is as follows:

Order No.	Length [m]
1401376	34.5
	Increment: 0.5 m;
	Length min.: 0.5 m
	Length max.: 50 m

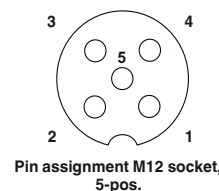
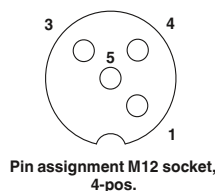

Sensor/actuator cabling

Distributor boxes

M12 distributor with metal thread, heavy-duty



With a master cable



With halogen-free master line



Plug-in screw connection, horizontal

General data	
Degree of protection in acc. with IEC 60529/EN 60529	
M12 circular connector according to:	
Electrical data	
Rated current for each I/O signal	[A]
Rated current per slot	[A]
Rated current, total	[A]
Total rated current for electrical isolation	[A]
Dimensions	
Width x height	[mm]
Length (4 / 6 / 8 / 10 slots)	[mm]
Temperature data	
Distributor box	[°C]
Master cable, fixed installation	[°C]
Master cable, flexible installation	[°C]

Technical data	Technical data	Technical data
IP65 / IP67 / IP69K IEC 61076-2-101	IP65 / IP67 / IP69K IEC 61076-2-101	IP65 / IP67 / IP69K IEC 61076-2-101
2 4 12 -	2 4 12 -	2 4 10 2x 8
58 x 26 117 / 126 / 153 / -	58 x 26 116 / 126 / 153 / -	58 x 45 117 / 126 / 153 / -
-30 ... 90 -40 ... 90 -5 ... 80	-30 ... 90 -40 ... 90 -5 ... 80	-30 ... 80 - -

Status indication	Signal type	Rated voltage	Slots	Cable length
Without LED	Universal	120 V	4	-
Without LED	Universal	120 V	4	5 m
Without LED	Universal	120 V	4	10 m
Without LED	Universal	120 V	6	-
Without LED	Universal	120 V	6	5 m
Without LED	Universal	120 V	6	10 m
Without LED	Universal	120 V	8	-
Without LED	Universal	120 V	8	5 m
Without LED	Universal	120 V	8	10 m
With LED	PNP	24 V DC	4	-
With LED	PNP	24 V DC	4	5 m
With LED	PNP	24 V DC	4	10 m
With LED	PNP	24 V DC	4	Variable
With LED	PNP	24 V DC	6	-
With LED	PNP	24 V DC	6	5 m
With LED	PNP	24 V DC	6	10 m
With LED	PNP	24 V DC	6	Variable
With LED	PNP	24 V DC	8	-
With LED	PNP	24 V DC	8	1.5 m
With LED	PNP	24 V DC	8	5 m
With LED	PNP	24 V DC	8	10 m
With LED	PNP	24 V DC	8	Variable
With LED	NPN	24 V DC	4	-
With LED	NPN	24 V DC	4	Variable
With LED	NPN	24 V DC	6	-
With LED	NPN	24 V DC	6	Variable
With LED	NPN	24 V DC	8	-
With LED	NPN	24 V DC	8	Variable

Ordering data		Ordering data		Ordering data	
Single occupancy	Double occupancy	Single occupancy	Double occupancy	Single occupancy	Double occupancy
-	-	-	-	1516849	1516852
1516962	1516988	-	1517204	-	-
1516975	1516991	-	1517217	-	-
-	-	-	-	1516865	1516878
1517000	1517026	-	1517220	-	-
1517013	1517039	-	1517233	-	-
-	-	-	-	1516881	1516894
1517042	1517068	-	1517246	-	-
1517055	1517071	-	1517259	-	-
-	-	-	-	1516784	1516797
1517084	1517107	-	1517262	-	-
1517097	1517110	-	1517275	-	-
1516904	1516917	-	-	-	-
-	-	-	-	1516807	1516810
1517123	1517149	-	1517288	-	-
1517136	1517152	-	1517291	-	-
1516920	1516933	-	-	-	-
-	-	-	-	1516823	1516836
-	-	-	-	-	-
1517165	1517181	-	1517301	-	-
1517178	1517194	-	1517314	-	-
1516946	1516959	-	-	-	-
-	-	-	-	1537077	1537103
1537019	1537048	-	-	-	-
-	-	-	-	1537080	1537116
1537022	1537051	-	-	-	-
-	-	-	-	1537093	1537129
1537035	1537064	-	-	-	-

For accessories, refer to page
 For master cable rings, see page
 For master cable data, see page

Notes:	Notes:	Notes:
293	293	293
313	315	285

Ordering example for products with variable master cable:

For a distributor with 4 single-occupancy slots and a master cable length of 34.5 m, the ordering data is as follows:

Order No.	Length [m]
1516904	34.5
	Increment: 0.5 m; Length min.: 0.5 m Length max.: 50 m

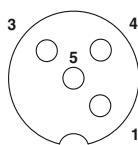

Pin assignment for M12 socket, 4-pos.

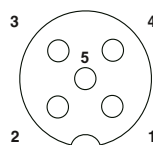

Pin assignment for M12 socket, 5-pos.

Sensor/actuator cabling

Distributor boxes

**QUICKON distributor,
connection cross section:
0.14 mm² ... 0.34 mm²**



With a master cable



Plug-in screw connection,
horizontal

General data	
Degree of protection in acc. with IEC 60529/EN 60529	
Electrical data	
Rated current for each I/O signal	[A]
Rated current per slot	[A]
Rated current, total	[A]
Total rated current for electrical isolation	[A]
Dimensions	
Width x height	[mm]
Length (4 / 6 / 8 / 10 slots)	[mm]
Temperature data	
Distributor box	[°C]
Master cable, fixed installation	[°C]
Master cable, flexible installation	[°C]

.FA US EAC		.FA US EAC	
Technical data		Technical data	
IP65 / IP67 / IP69K		IP65 / IP67 / IP69K	
	2		2
	4		4
	12		10
	-		2x 8
	58 x 45		58 x 45
	116 / 126 / 153 / -		117 / 126 / 153 / -
	-30 ... 80		-30 ... 80
	-40 ... 90		-
	-5 ... 80		-

Status indication	Signal type	Rated voltage	Slots	Cable length
Without LED	Universal	48 V	4	-
Without LED	Universal	48 V	4	Variable
Without LED	Universal	48 V	6	-
Without LED	Universal	48 V	8	-
Without LED	Universal	48 V	8	Variable
With LED	PNP	24 V DC	4	-
With LED	PNP	24 V DC	4	5 m
With LED	PNP	24 V DC	4	10 m
With LED	PNP	24 V DC	4	Variable
With LED	PNP	24 V DC	6	-
With LED	PNP	24 V DC	8	-
With LED	PNP	24 V DC	8	5 m
With LED	PNP	24 V DC	8	10 m
With LED	PNP	24 V DC	8	Variable

Ordering data		Ordering data	
Single occupancy	Double occupancy	Single occupancy	Double occupancy
-	-	1548354	1548419
1548642	1548671	-	-
-	-	1548367	1548422
-	-	1548370	1548435
1548668	1548697	-	-
-	-	1548325	1548383
1548448	1548532	-	-
1548451	1548545	-	-
1548503	1548590	-	-
-	-	1548338	1548396
-	-	1548341	1548406
1548480	1548574	-	-
1548493	1548587	-	-
1548529	1548613	-	-

For accessories, refer to page
For master cable rings, see page
For master cable data, see page

Notes:	Notes:
295	295
312	285

Ordering example for products with variable master cable:

For a distributor with 4 single-occupancy QUICKON slots and a master cable length of 34.5 m, the ordering data is as follows:

Order No.	Length [m]
1548503	34.5
	Increment: 0.5 m; Length min.: 0.5 m Length max.: 50 m

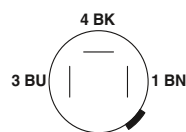

Pin assignment for QUICKON connection, 3-pos.

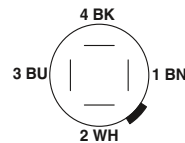

Pin assignment for QUICKON connection, 4-pos.

**QUICKON distributor,
connection cross section:
0.34 mm² ... 0.75 mm²**



With a master cable



Spring connection, horizontal

General data	
Degree of protection in acc. with IEC 60529/EN 60529	
Electrical data	
Rated current for each I/O signal	[A]
Rated current per slot	[A]
Rated current, total	[A]
Dimensions	
Width x height	[mm]
Length (4 / 6 / 8 / 10 slots)	[mm]
Temperature data	
Distributor box	[°C]
Master cable, fixed installation	[°C]
Master cable, flexible installation	[°C]

Phoenix Contact		Phoenix Contact	
Technical data		Technical data	
IP65 / IP67		IP65 / IP67	
4	4	4	4
4	4	4	4
12	12	12	12
60 x 44		60 x 44	
97 / 134 / 170 / -		132 / 168 / 205 / -	
-25 ... 60		-25 ... 60	
-40 ... 90		-	
-5 ... 80		-	

Status indication	Signal type	Rated voltage	Slots	Cable length
Without LED	Universal	120 V	4	-
Without LED	Universal	120 V	4	5 m
Without LED	Universal	120 V	4	10 m
Without LED	Universal	120 V	6	-
Without LED	Universal	120 V	6	5 m
Without LED	Universal	120 V	6	10 m
Without LED	Universal	120 V	8	-
Without LED	Universal	120 V	8	5 m
Without LED	Universal	120 V	8	10 m
With LED	PNP	24 V DC	4	-
With LED	PNP	24 V DC	4	5 m
With LED	PNP	24 V DC	4	10 m
With LED	PNP	24 V DC	4	Variable
With LED	PNP	24 V DC	6	-
With LED	PNP	24 V DC	6	5 m
With LED	PNP	24 V DC	6	10 m
With LED	PNP	24 V DC	6	Variable
With LED	PNP	24 V DC	8	-
With LED	PNP	24 V DC	8	5 m
With LED	PNP	24 V DC	8	10 m
With LED	PNP	24 V DC	8	Variable
With LED	NPN	24 V DC	4	-
With LED	NPN	24 V DC	6	-
With LED	NPN	24 V DC	8	-

Phoenix Contact		Phoenix Contact	
Ordering data		Ordering data	
Single occupancy	Double occupancy	Single occupancy	Double occupancy
-	-	1683633	-
1683662	-	-	-
1683675	-	-	-
-	-	1683646	-
1683688	-	-	-
1683691	-	-	-
-	-	1683659	-
1683701	-	-	-
1683714	-	-	-
-	-	1662939	-
1695223	-	-	-
1695236	-	-	-
1695249	-	-	-
-	-	1662942	-
1695252	-	-	-
1695265	-	-	-
1695278	-	-	-
-	-	1662955	-
1695281	-	-	-
1695294	-	-	-
1695304	-	-	-
-	-	1680856	-
-	-	1680869	-
-	-	1680872	-

For accessories, refer to page
 Master cable rings, refer to page
 For master cable data, see page

Notes:	Notes:
296	296
313	285

Ordering example for products with variable master cable:

For a distributor with 4 single-occupancy QUICKON slots and a master cable length of 34.5 m, the ordering data is as follows:

Order No.	Length [m]
1695249	34.5
	Increment: 0.5 m;
	Length min.: 0.5 m
	Length max.: 50 m

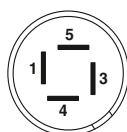

Pin assignment for QUICKON connection, 4-pos.

Distributor boxes

M12 distributor, shielded, with metal housing



With a master cable



M23 plug-in connection, vertical

General data	
Degree of protection in acc. with IEC 60529/EN 60529	
M12 circular connector according to:	
Electrical data	
Rated current for each I/O signal	[A]
Rated current per slot	[A]
Rated current, total	[A]
Dimensions	
Width x height	[mm]
Length (4 / 6 / 8 / 10 slots)	[mm]
Temperature data	
Distributor box	[°C]
Master cable, fixed installation	[°C]
Master cable, flexible installation	[°C]

ERC	ERC
Technical data	Technical data
IP65 / IP67	IP65 / IP67
IEC 61076-2-101	IEC 61076-2-101
2	2
4	4
12	12
61 x 24	61 x 31
116 / 129 / 156 / -	117 / 130 / 157 / -
-25 ... 70	-25 ... 70
-40 ... 90	-
-5 ... 80	-

Status indication	Signal type	Rated voltage	Slots	Cable length
Without LED	Universal	48 V	4	-
Without LED	Universal	48 V	4	5 m
Without LED	Universal	48 V	4	10 m
Without LED	Universal	48 V	6	-
Without LED	Universal	48 V	6	5 m
Without LED	Universal	48 V	6	10 m
Without LED	Universal	48 V	8	-
Without LED	Universal	48 V	8	5 m
Without LED	Universal	48 V	8	10 m

Ordering data		Ordering data	
Single occupancy	Double occupancy	Single occupancy	Double occupancy
-	-	-	1695757
-	1695786	-	-
-	1695799	-	-
-	-	-	1695760
-	1695809	-	-
-	1695812	-	-
-	-	-	1695773
-	1695825	-	-
-	1695838	-	-

For accessories, refer to page
 For master cable rings, see page
 For master cable data, see page

Notes:	Notes:
294	294
314	285

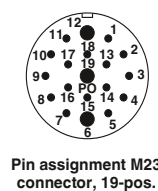
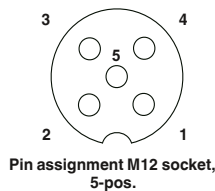

M5 distributor with metal thread

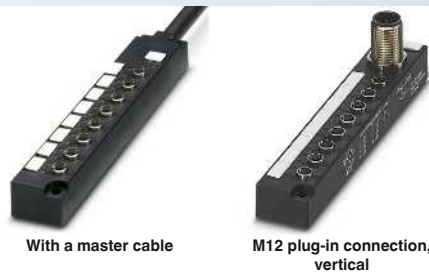

General data	
Degree of protection in acc. with IEC 60529/EN 60529	
M5 circular connector according to:	
M12 circular connector according to:	
Electrical data	
Rated current for each I/O signal	[A]
Rated current per slot	[A]
Rated current, total	[A]
Dimensions	
Width x height	[mm]
Length (4 / 6 / 8 / 10 slots)	[mm]
Temperature data	
Distributor box	[°C]
Master cable, fixed installation	[°C]
Master cable, flexible installation	[°C]

ERC		ERC	
Technical data		Technical data	
IP67		IP67	
IEC 61076-2-105		IEC 61076-2-105	
-		IEC 61076-2-101	
1	1	1	1
1	1	1	1
3	3	3	3
20 x 14		20 x 28	
76 / - / 116 / -		76 / - / 116 / -	
-25 ... 80		-25 ... 80	
-30 ... 70		-	
-5 ... 70		-	

Status indication	Signal type	Rated voltage	Slots	Cable length
With LED	PNP	24 V DC	4	-
With LED	PNP	24 V DC	4	5 m
With LED	PNP	24 V DC	4	10 m
With LED	PNP	24 V DC	8	-
With LED	PNP	24 V DC	8	5 m
With LED	PNP	24 V DC	8	10 m

ERC		ERC	
Ordering data		Ordering data	
Single occupancy	Double occupancy	Single occupancy	Double occupancy
-	-	1530760	-
1530663	1530702	-	-
1530676	1530715	-	-
-	-	1530773	-
1530689	1530744	-	-
1530692	1530757	-	-

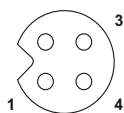

Pin assignment for M5 socket, 3-pos.

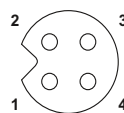

Pin assignment for M5 socket, 4-pos.

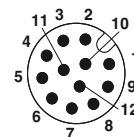

Pin assignment for M12 plug-in connection, 12-pos.



Versatile

Whether in the railway station, for control tasks or within rolling stock - our cables for the railway industry support flexible use.



Comprehensive portfolio

In addition to crimp and spring-cage connectors suitable for the rail industry, the product range includes assembled sensor/actuator cables with A-coding and data cables with D and X-coding for communication networks and passenger information systems.



Safe transmission

With 360° shielded connectors and cables, you can transmit signals reliably even in critical EMI applications.



Material selection

One of the most important aspects when choosing the right components for use in railway applications is material selection. We only use PA 6.6 as molding material which satisfies the stringent requirements regarding behavior in fire.



Securely locked

The vibration brake in the form of a wave shape with counterpart prevents the unintentional loosening of the plug-in connection in the event of vibrations.

The connectors are tested according to EN 50155 for resistance to shock and vibrations.



Temperature testing

Our products are intensively tested for an extended temperature range and for resistance to temperature shocks.



Certified according to IRIS

The Phoenix Contact Group is currently IRIS-certified. IRIS is an international rail industry standard for quality management systems.

Find out more with the web code

Detailed information on these products can be found on our website. Simply enter # and numbers in the search field.





Resistance to cleaning agents

The connectors in hygienic and washdown design are tested for resistance to cleaning agents commonly used in the food industry in accordance with Diversey and ECOLAB standards.



Product-contacting area

The components and devices used here must meet the highest hygienic requirements. Our cabling in hygienic design is suitable for use in this area.



Splash zone

The products in washdown design are suitable for the splash zone. Cost-effective features include resistance to cleaning agents and cleaning methods.



Connectors for the splash zone

For the special requirements of the food industry, we offer flush-type connectors and connectors with stainless steel components for assembly.



Assembled cables for all areas

Molded cables are available with connectors in sizes M8 and M12 in hygienic or washdown design.



Distributor boxes for the splash zone

Distributor boxes with stainless steel housing and permanently connected PVC master cable in washdown design are available for the splash zone.



Mechanical resistance

All components for the food industry are IP69K tested. This means guaranteed sealing for applications with steam jets, even after repeated temperature shocks.

Find out more with the web code

Detailed information on these products can be found on our website. Simply enter # and numbers in the search field.



Sensor/actuator cabling

Cabling for outdoor applications



Adapted to the relevant requirements

Through the selection of special materials, the components are designed for use outdoors. The materials are resistant to UV, ozone, corrosion, and temperatures.



For a variety of applications

Outdoor components are particularly suitable for use in traffic management systems, snow cats and snow cannons, photovoltaic systems or wind power plants.



UV and ozone test

Testing with special climate cabinets ensures that the connectors and cables are suitable for the control of solar plants, for example, without any restrictions.



Connectors for assembly

The connector knurls are made from stainless steel and the plastics are resistant to atmospheric influences. The connectors are available with insulation displacement connection and screw connection.



Assembled cables

In addition to 4, 5, and 8-pos. shielded and unshielded versions, PROFINET and Ethernet cables for data applications are also available.



Distributor boxes

Robust, fully molded sensor/actuator distributor boxes with 8 slots are available with fixed master cable or plug-in screw connection.



IP69K protection

For outdoor applications, a high IP protection class is essential because products are exposed to direct atmospheric influences.

Find out more with the web code

Detailed information on these products can be found on our website. Simply enter # and numbers in the search field.



Sensor/actuator cabling

Cabling for robots and drag chains



High level of durability

With their special design, our cables provide a high level of durability under alternating bending stress, e.g., in drag chains.



High level of resistance to welding sparks

The robust TPE-U outer sheath of the highly flexible cables is resistant to welding sparks and is particularly suitable for use in the field of resistance welding processes.



High level of durability under torsional stress

Our cables achieve a high level of durability - even with large angles of torsion and simultaneous bending stress.

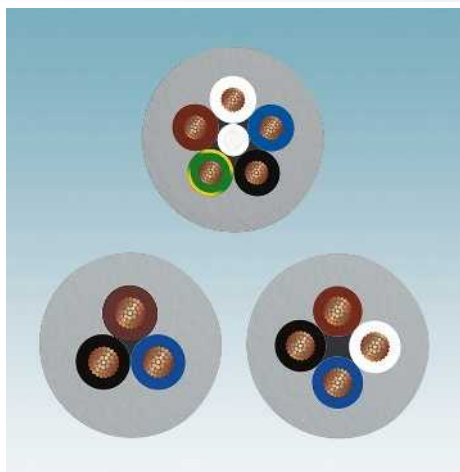

Large selection of number of positions

Our sensor/actuator cables for robots and drag chains are available in 3, 4, and 5-pos. versions.



Large selection of connectors

Sensor/actuator cables with molded connectors are available both as plugs and sockets and with a straight or angled cable outlet.



Highly flexible master cable

For the distribution or grouping of signals at industrial robots, we offer a corresponding sensor/actuator box with special master cable.



100% tested

All supplied components are 100% electrically checked by Quality Assurance.

Find out more with the web code

Detailed information on these products can be found on our website. Simply enter # and numbers in the search field.





Compact size with maximum current carrying capacity

With the M12 power connectors, the M12 design opens up new areas of application for energy supply.



DC application

The M12 power T and L DC codings are particularly suitable for the supply connection for I/O modules or for DC motors.



AC application

The M12 power S, K, and M AC codings are particularly suitable for the supply connection for AC motors.



Connectors for assembly

M12 connectors in straight and angled version with screw connection are available for power transmission.



Safe transmission

With 360° shielded connectors and cables, you can transmit signals reliably even in critical EMI applications.



Power distributors

An M12 box with and without diagnostics function plus a Y-distributor with T-coding are available for power distribution.



100% tested

All supplied components are 100% electrically checked by Quality Assurance.

Find out more with the web code

Detailed information on these products can be found on our website. Simply enter # and numbers in the search field.



Sensor/actuator cabling

Cabling for power applications

M12, power connector, screw connection



Metal knurl, 3-pos. + PE, S-coded



Metal knurl, 4-pos., T-coded



Technical data

3-pos. + PE

General data
Pollution degree
Degree of protection
Connection method
Connection cross section [mm ²]
Electrical data
Rated voltage
Rated current
Insulation resistance
Material data
Material contact/contact surface
Contact carrier material
Inflammability class according to UL 94
Temperature data
Plug/socket

3
IP67
Screw connection
0.75 mm ² ... 1.5 mm ²
630 V AC
12 A
> 10 GΩ
CuZn / Au
PA
V0
-40 ... 85



Technical data

4-pos.

3
IP67
Screw connection
0.75 mm ² ... 1.5 mm ²
63 V DC
12 A
> 10 GΩ
CuZn / Au
PA
V0
-40 ... 85

Ordering data

Description	Type	Order No.	Pcs. / Pkt.
Connector, cable diameter: 8 mm ... 10 mm			
Socket, straight	SACC-M12FSS-3PECON-PG11-M	1404642	1
Plug, straight	SACC-M12MSS-3PECON-PG11-M	1404641	1
Socket, angled	SACC-M12FRS-3PECON-PG11-M	1408987	1
Plug, angled	SACC-M12MRS-3PECON-PG11-M	1408985	1

Ordering data

Description	Type	Order No.	Pcs. / Pkt.
Socket, straight	SACC-M12FST-3PECON-PG11-M	1404644	1
Plug, straight	SACC-M12MST-3PECON-PG11-M	1404643	1
Socket, angled	SACC-M12FRT-4CON-PG11-M	1408989	1
Plug, angled	SACC-M12MRT-4CON-PG11-M	1408988	1



Connector pin assignment of M12 socket, 4-pos., S-coded, view of socket side

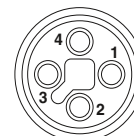

Connector pin assignment of M12 socket, 4-pos., T-coded, view of socket side



Connector pin assignment of M12 connector, 4-pos., S-coded, view of pin side

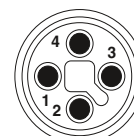

Connector pin assignment of M12 connector, 4-pos., T-coded, view of pin side

M12 power device connector, modular, 25 mm square flange, pre-assembled



Flange housing, 2.7 mm housing bore holes



Preassembled contact carrier and insulating body with 0.5 m long litz wires

ERC

Technical data	
General data	
Pollution degree	-
Degree of protection	-
Connection method	-
Electrical data	
Rated voltage	-
Rated current	-
Surge voltage category	-
Material data	
Material contact/contact surface	- / -
Contact carrier material	-
Cable gland material	Zinc die-cast, nickel-plated
Cable type	-
Temperature data	
Plug/socket	[°C] -40 ... 85
Cable, fixed installation	[°C] -

Ordering data	
Order No.	Pcs. / Pkt.
1424131	10

ERC

Technical data	
S-coded, 3-pos. + PE	T-coded, 4-pos.
3	3
IP67	IP67
Individual wires	Individual wires
630 V	60 V
12 A	12 A
III	III
CuZn / Au	CuZn / Au
PA6	PA6
-	-
PP litz wire	PP litz wire
-25 ... 85	-25 ... 85
-40 ... 90	-40 ... 90

Ordering data	
Order No.	Pcs. / Pkt.
1424129	1
1424130	1

Description
Square flange housing, with flat gasket
Assembled contact carrier and insulating body, with 0.5 m litz wires and crimp contacts
Plug

Sensor/actuator cabling

Cabling for power applications

M12 power device connector, 2-pos. + PE

- M16 fastening thread
- With 0.5 m long litz wires
- S-coded



S-coded, 2-pos. + PE

		Technical data			
		Front mounting		Rear mounting	
General data					
Pollution degree		3		3	
Degree of protection		IP65/IP67		IP65/IP67	
Connection method		Individual wires		Individual wires	
Electrical data					
Rated voltage		630 V		630 V	
Rated current		16 A		16 A	
Material data					
Material contact/contact surface		CuZn / Au		CuZn / Au	
Contact carrier material		PA		PA	
Inflammability class according to UL 94		V0		V0	
Cable type		PP litz wire		PP litz wire	
Temperature data					
Plug/socket		-25 ... 105 [°C]		-25 ... 105	
		Ordering data			
		Order No.	Pcs. / Pkt.	Order No.	Pcs. / Pkt.
		Front mounting		Rear mounting	
Description					
Coding					
Power device connectors					
Socket					
Plug					
		1411654	1	1411652	1
		1411655	1	1411653	1
		Accessories			
Flat nut, with: M16 thread		SACC-E-MU-M16		1504097	100

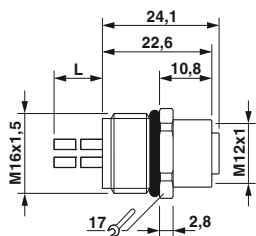

Dimensions: socket, front mounting

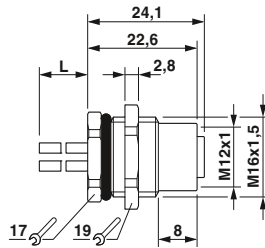

Dimensions: socket, rear mounting

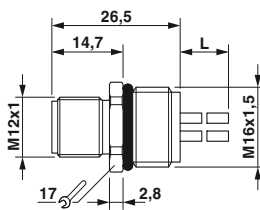

Dimensions: plug, front mounting

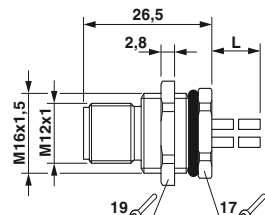

Dimensions: plug, rear mounting

M12 power device connector, 3-pos. + PE and 4-pos.

- M16 fastening thread
- With 0.5 m long litz wires



S-coded, 3-pos. + PE



T-coded, 4-pos.

ERC

	Technical data	
	Front mounting	Rear mounting
General data		
Pollution degree	3	3
Degree of protection	IP65/IP67	IP65/IP67
Connection method	Individual wires	Individual wires
Electrical data		
Rated voltage	630 V	630 V
Rated current	12 A	12 A
Material data		
Material contact/contact surface	CuZn / Au	CuZn / Au
Contact carrier material	PA	PA
Inflammability class according to UL 94	V0	V0
Cable type	PP litz wire	PP litz wire
Temperature data		
Plug/socket	[-25 ... 85 °C]	[-25 ... 85 °C]
Cable, fixed installation	[-40 ... 90 °C]	[-40 ... 90 °C]

Description	Ordering data			
	Order No.	Pcs. / Pkt.	Order No.	Pcs. / Pkt.
	Front mounting		Rear mounting	
Power device connectors				
Socket	1424137	1	1424133	1
Plug	1424139	1	1424132	1

Flat nut, with: M16 thread	Accessories	
	Order No.	Pcs. / Pkt.
	SACC-E-MU-M16	1504097 100

ERC

	Technical data	
	Front mounting	Rear mounting
General data		
Pollution degree	3	3
Degree of protection	IP65/IP67	IP65/IP67
Connection method	Individual wires	Individual wires
Electrical data		
Rated voltage	60 V	60 V
Rated current	12 A	12 A
Material data		
Material contact/contact surface	CuZn / Au	CuZn / Au
Contact carrier material	PA	PA
Inflammability class according to UL 94	V0	V0
Cable type	PP litz wire	PP litz wire
Temperature data		
Plug/socket	[-25 ... 85 °C]	[-25 ... 85 °C]
Cable, fixed installation	[-40 ... 90 °C]	[-40 ... 90 °C]

Description	Ordering data			
	Order No.	Pcs. / Pkt.	Order No.	Pcs. / Pkt.
	Front mounting		Rear mounting	
Power device connectors				
Socket	1424138	1	1424134	1
Plug	1424140	1	1424136	1

Flat nut, with: M16 thread	Accessories	
	Order No.	Pcs. / Pkt.
	SACC-E-MU-M16	1504097 100

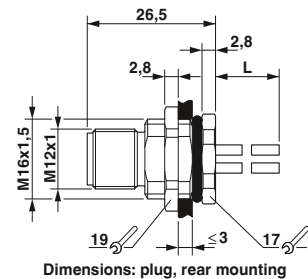
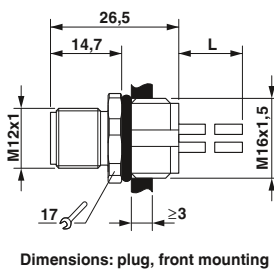
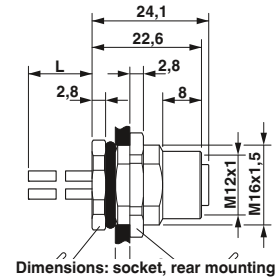
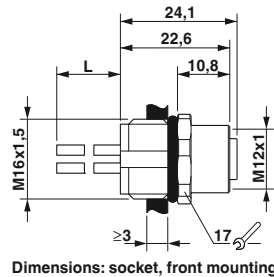

**M12-SPEEDCON power cable,
2-pos.+PE, unshielded**

Notes:
For information about the cable qualities, see page 298

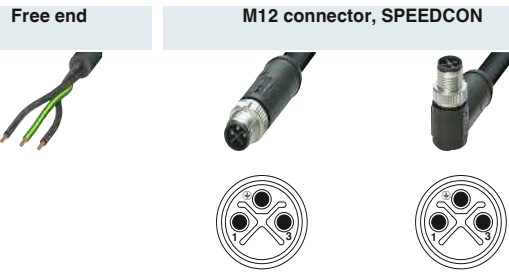

Ordering data Ordering data Ordering data

Free end	Order No.	Order No.	Order No.
	1 m	1411636	1 m 1411640
	2 m	1411637	2 m 1411641
	5 m	1411638	5 m 1411642
	10 m	1411639	10 m 1411643

M12 socket, SPEEDCON, straight	Order No.
	1 m 1411644
	2 m 1411645
	5 m 1411646
	10 m 1411647

M12 socket, SPEEDCON, angled	Order No.
	1 m 1411648
	2 m 1411649
	5 m 1411650
	10 m 1411651

Cable description	Cable type	Color coding	Pin assignment
PVC - black	PVC	BK1 1	1
		BK2 2	3
		GNYE	PE

		Technical data
		M12
Rated voltage	[V]	230
Rated current	[A]	16
Inflammability class in acc. with UL 94		V0
Material contact M12		CuZn
Material contact surface M12		Au
Material handle M12		TPU, hardly inflammable, self-extinguishing
Material, knurls		Zinc die-cast, nickel-plated
Degree of protection		IP67
Temperature data		
Plug/socket	[°C]	-25 ... 105

Sensor/actuator cabling

Cabling for power applications

M12-SPEEDCON power cable, 3-pos.+PE, S-coded, unshielded

Notes:

For information about the cable qualities, see page 298

Free end





M12 connector, SPEEDCON



Ordering data

Ordering data

Ordering data

Free end	Order No.	Order No.	Order No.
	1 m	1408835	1 m 1408839
	2 m	1408836	2 m 1408840
	5 m	1408837	5 m 1408841
	10 m	1408838	10 m 1408842
M12 socket, SPEEDCON, straight 	1 m	1408843	
	2 m	1408844	
	5 m	1408845	
	10 m	1408846	
M12 socket, SPEEDCON, angled 	1 m	1408848	
	2 m	1408852	
	5 m	1408853	
	10 m	1408854	

Cable description	Cable type	Color coding	Pin assignment
PUR, halogen-free - black	PUR	BK1	1
		BK2	2
		BK3	3
		GNYE	PE

Technical data

		M12
Rated voltage	[V]	630
Rated current	[A]	12
Material contact M12		CuZn
Material contact surface M12		Au
Material handle M12		TPU, hardly inflammable, self-extinguishing
Material, knurls		Zinc die-cast, nickel-plated
Degree of protection		IP65 / IP67
Temperature data		
Plug/socket	[°C]	-25 ... 85

M12-SPEEDCON power cable, 3-pos.+PE, S-coded, shielded

Notes:
For information about the cable qualities, see page 298

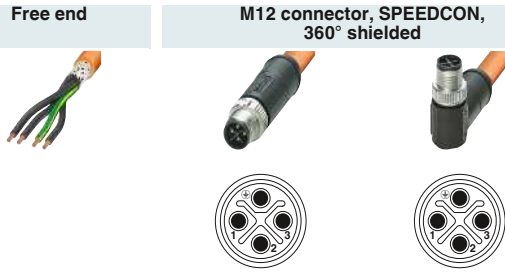

Ordering data

Free end	Order No.	Order No.	Order No.
		1.5 m	1.5 m
		3 m	3 m
		5 m	5 m
		10 m	10 m

M12 socket, SPEEDCON, straight, 360° shielded	Order No.
	1.5 m
	3 m
	5 m
	10 m

M12 socket, SPEEDCON, angled, 360° shielded	Order No.
	1.5 m
	3 m
	5 m
	10 m

Cable description	Cable type	Color coding	Pin assignment
PUR, halogen-free - orange	PUR	BK1 1	1
		BK2 2	2
		BK3 3	3
		GNYE	PE

Technical data

		M12
Rated voltage	[V]	630
Rated current	[A]	12
Material contact M12		CuZn
Material contact surface M12		Au
Material handle M12		TPU, hardly inflammable, self-extinguishing
Material, knurls		Zinc die-cast, nickel-plated
Degree of protection		IP65 / IP67
Temperature data		
Plug/socket	[°C]	-25 ... 85

Sensor/actuator cabling

Cabling for power applications

M12-SPEEDCON power cable, 4-pos., T-coded, unshielded

Notes:
For information about the cable qualities, see page 298

Free end



M12 connector, SPEEDCON



Ordering data

Ordering data

Ordering data

Free end	Order No.	Order No.	Order No.
	1 m	1408812	1 m 1408816
	2 m	1408813	2 m 1408819
	5 m	1408814	5 m 1408820
	10 m	1408815	10 m 1408822
M12 socket, SPEEDCON, straight 	1 m	1408823	1 m 1408808
	2 m	1408824	2 m 1408809
	5 m	1408825	5 m 1408810
	10 m	1408826	10 m 1408811
M12 socket, SPEEDCON, angled 	1 m	1408827	1 m 1415196
	2 m	1408828	2 m 1415197
	5 m	1408829	5 m 1415198
	10 m	1408830	10 m 1415199

Cable description	Cable type	Color coding	Pin assignment												
PUR, halogen-free - black	PUR	<table border="1"> <tr><td>BN</td><td></td><td>1</td></tr> <tr><td>WH</td><td></td><td>2</td></tr> <tr><td>BK</td><td></td><td>4</td></tr> <tr><td>BU</td><td></td><td>3</td></tr> </table>	BN		1	WH		2	BK		4	BU		3	
BN		1													
WH		2													
BK		4													
BU		3													

Technical data

		M12
Rated voltage	[V]	60
Rated current	[A]	12
Material contact M12		CuZn
Material contact surface M12		Au
Material handle M12		TPU, hardly inflammable, self-extinguishing
Material, knurls		Zinc die-cast, nickel-plated
Degree of protection		IP65 / IP67
Temperature data		
Plug/socket	[°C]	-25 ... 85

**M12-SPEEDCON power cable,
4-pos., T-coded,
shielded**

Notes:
For information about the cable qualities, see page 298

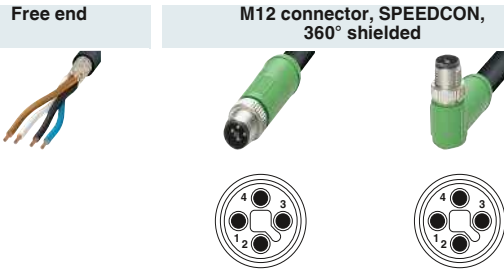

Ordering data **Ordering data** **Ordering data**

Free end	Order No.	Order No.	Order No.
		1.5 m 1424120	1.5 m 1424124
		3 m 1424121	3 m 1424125
		5 m 1424122	5 m 1424126
		10 m 1424123	10 m 1424127

M12 socket, SPEEDCON, straight, 360° shielded	Order No.	Order No.
	1.5 m 1424112	
	3 m 1424113	
	5 m 1424114	
	10 m 1424115	

M12 socket, SPEEDCON, angled, 360° shielded	Order No.	Order No.
	1.5 m 1424116	1.5 m 1415202
	3 m 1424117	3 m 1415203
	5 m 1424118	5 m 1415204
	10 m 1424128	10 m 1415205

Cable description	Cable type	Color coding	Pin assignment
PUR, halogen-free - black	PUR	BN	1
		WH	2
		BK	4
		BU	3

Technical data

		M12
Rated voltage	[V]	60
Rated current	[A]	12
Material contact M12		CuZn
Material contact surface M12		Au
Material handle M12		TPU, hardly inflammable, self-extinguishing
Material, knurls		Zinc die-cast, nickel-plated
Degree of protection		IP65 / IP67
Temperature data		
Plug/socket	[°C]	-25 ... 85

Sensor/actuator cabling

Cabling for power applications

7/8" power cable, 4-pos. + PE, PUR cable, 1.5 mm²





Notes:
For information about the cable qualities, see page 304

Free end



7/8" connector



	Ordering data	Ordering data	Ordering data	
	Order No.	Order No.	Order No.	
7/8" socket, straight  	1.5 m	1443705	0.3 m 1443802	
	3 m	1443718	0.6 m 1443815	
	5 m	1443721	1 m 1443828	
	7.5 m	1443734	1.5 m 1443831	
	10 m	1443747	2 m 1443844	
7/8" socket, angled  	1.5 m	1443750	0.3 m 1443857	
	3 m	1443763	0.6 m 1443860	
	5 m	1443776	1 m 1443873	
	7.5 m	1443789	1.5 m 1443886	
	10 m	1443792	2 m 1443899	



Cable description	Cable type	Color coding	Pin assignment
PUR/PVC 1.5 mm ² - gray	440	BK1	1
		BK2	2
		BK3	3
		BK4	4
		GNYE	5
			3

		Technical data
		7/8", 1.5 mm ²
Rated voltage	[V]	600
Rated current	[A]	10
Contact material		CuZn
Contact surface material		AU
Material of grip body		TPU
Degree of protection		IP65 / IP67 / IP68
Temperature data		
Plug/socket	[°C]	-40 ... 90

**7/8" power cable, 4-pos. + PE,
PUR cable, 2.5 mm²**

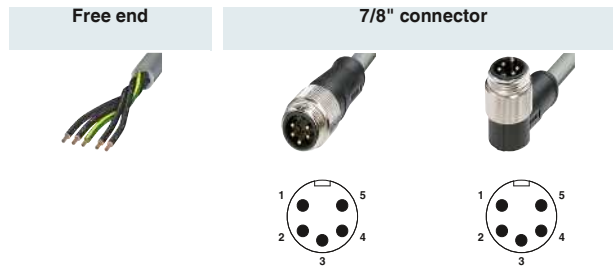
Notes:
For information about the cable qualities, see page 304

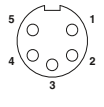

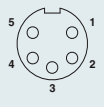
		Ordering data		Ordering data		Ordering data	
		Order No.		Order No.		Order No.	
7/8" socket, straight  	1.5 m	1443909	0.3 m	1419823			
	3 m	1443912	0.6 m	1419836			
	5 m	1443925	1 m	1419849			
	7.5 m	1443938	1.5 m	1419852			
	10 m	1443941	2 m	1419865			
7/8" socket, angled  	1.5 m	1443954	0.3 m	1419878			
	3 m	1443967	0.6 m	1419881			
	5 m	1443970	1 m	1419894			
	7.5 m	1419807	1.5 m	1419904			
	10 m	1419810	2 m	1419917			

Cable description	Cable type	Color coding		Pin assignment
PUR/PVC 2.5 mm ² - gray	441	BK1	1	1
		BK2	2	2
		BK3	3	4
		BK4	4	5
		GNYE	3	3

		Technical data	
		7/8", 2.5 mm ²	
Rated voltage	[V]	600	
Rated current	[A]	13	
Contact material		CuZn	
Contact surface material		AU	
Material of grip body		TPU	
Degree of protection		IP65 / IP67 / IP68	
Temperature data			
Plug/socket	[°C]	-40 ... 90	

Sensor/actuator cabling

Cabling for power applications

**7/8" power cable, 4-pos. + PE,
PVC cable, 1.5 mm²**

Notes:





For information about the cable qualities, see page 304

Free end



7/8" connector



	Ordering data	Ordering data	Ordering data	
	Order No.	Order No.	Order No.	
7/8" socket, straight  	1.5 m	1443307	0.3 m 1443404	
	3 m	1443310	0.6 m 1443417	
	5 m	1443323	1 m 1443420	
	7.5 m	1443336	1.5 m 1443433	
	10 m	1443349	2 m 1443446	
7/8" socket, angled  	1.5 m	1443352	0.3 m 1443459	
	3 m	1443365	0.6 m 1443462	
	5 m	1443378	1 m 1443475	
	7.5 m	1443381	1.5 m 1443488	
	10 m	1443394	2 m 1443491	





Cable description	Cable type	Color coding	Pin assignment
PVC 1.5 mm ² - gray	430	BK1	1
		BK2	2
		BK3	3
		BK4	4
		GNYE	5
			3

		Technical data
		7/8", 1.5 mm ²
Rated voltage	[V]	600
Rated current	[A]	10
Contact material		CuZn
Contact surface material		AU
Material of grip body		TPU
Degree of protection		IP65 / IP67 / IP68
Temperature data		
Plug/socket	[°C]	-40 ... 90

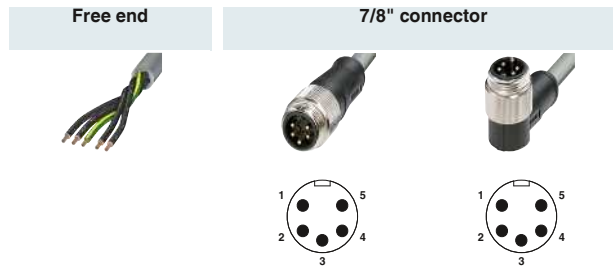
**7/8" power cable, 4-pos. + PE,
PVC cable, 2.5 mm²**

Notes:
For information about the cable qualities, see page 304



		Ordering data		Ordering data		Ordering data	
		Order No.		Order No.		Order No.	
7/8" socket, straight  	1.5 m	1443501	0.3 m	1443608			
	3 m	1443514	0.6 m	1443611			
	5 m	1443527	1 m	1443624			
	7.5 m	1443530	1.5 m	1443637			
	10 m	1443543	2 m	1443640			
7/8" socket, angled  	1.5 m	1443556	0.3 m	1443653			
	3 m	1443569	0.6 m	1443666			
	5 m	1443572	1 m	1443679			
	7.5 m	1443585	1.5 m	1443682			
	10 m	1443598	2 m	1443695			

Cable description	Cable type	Color coding		Pin assignment
PVC 2.5 mm ² - gray	431	BK1	1	1
		BK2	2	2
		BK3	3	4
		BK4	4	5
		GNYE	3	3

		Technical data	
		7/8", 2.5 mm ²	
Rated voltage	[V]	600	
Rated current	[A]	13	
Contact material		CuZn	
Contact surface material		AU	
Material of grip body		TPU	
Degree of protection		IP65 / IP67 / IP68	
Temperature data			
Plug/socket	[°C]	-40 ... 90	

M12 Y-distributor for power connectors



Y-distributor, T-coded, 4-pos.

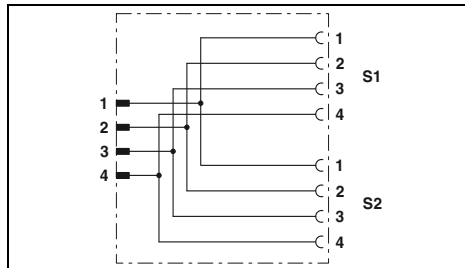

Technical data

General data	
Pollution degree	3
Degree of protection	IP65 / IP67
Electrical data	
Rated voltage	60 V
Rated current	2x 12 A (at 40 °C)
Material data	
Contact material	CuZn
Contact surface material	Ni/Au
Inflammability class according to UL 94	HB
Temperature data	
Plug/socket	[°C] -25 ... 80

Ordering data

Description	Center distance	Type	Order No.	Pcs. / Pkt.
Y-distributor, M12-SPEEDCON , unshielded, M12 connector (T-coded) to 2 x M12 socket (T-coded)	21 mm	SAC-4PY-MT/2XFT VP	1410632	5

**M12 distributor
for power connectors**



new



Power distributor with plug-in crimp connection, horizontal

Technical data	
General data	
Degree of protection	IP66 / IP67
Electrical data	
Rated voltage	24 V DC
Perm. operating voltage	30.5 V DC
Rated current for each I/O signal	10 A (M12 diagnostic socket for each channel max. 50 mA)
Rated current per slot	2x 9.25 A (at 40 °C)
Total rated current	-
Housing material	PBT
Dimensions	
Width x height x length [mm]	60 x 52 x 234
Temperature data	
Distributor box	-25 °C ... 60 °C

Ordering data			
Description	Type	Order No.	Pcs. / Pkt.
Power distributor , M12-SPEEDCON socket, 4 slots, 4-pos., unshielded, status indicator: yes			
- with diagnostics port	SACB-4/T-L-8FUSE DIAG CT AXL	1411048	1
- without diagnostics port	SACB-4/T-L-8FUSE CT AXL	1413929	1

Accessories			
Description	Type	Order No.	Pcs. / Pkt.
M12 screw plug with SPEEDCON quick locking For unused M12 sockets of sensor/actuator cables, boxes, and device connectors UniCard , for marking Phoenix Contact devices, Axioline Lettering field size: 7 x 10 mm, 30 individual labels	PROT-MS SCO	1553129	5
	UCT-EM (7X10)	0830765	10
Torque screwdriver With preset torque of 0.4 Nm and 4 mm hexagonal drive	TSD 04 SAC	1208429	1
Nut For assembling sensor/actuator cables with M12 connectors and for M12 connectors with insulation displacement connection, for 4 mm hexagonal screwdriver	SAC BIT M12-D15	1208432	1
Nut For assembling SACC M12 connectors, excluding those with insulation displacement connection, for 4 mm hexagonal screwdriver	SACC BIT M12-D20	1208445	1

Sensor/actuator cabling

By the meter

Cable rings for sensor cables

The special SAC cables are also available in 100 m cable rings for connecting the M8/M12 connectors that can be assembled.

Cables between 110 m and 500 m in length are supplied on cable drums. Please refer to the ordering example below.

Notes:
For information about the cable qualities, see page 298



Cable ring, 100 m, unshielded

Description	Ordering data		
	Type	Order No.	Pcs. / Pkt.
PUR, halogen-free - black, cable type: PUR 3 x 0.25 mm ² , conductor colors: BN/BU/BK 3 x 0.34 mm ² , conductor colors: BN/BU/BK 4 x 0.25 mm ² , conductor colors: BN/WH/BU/BK	SAC-3P-100,0-PUR/0,25	1501689	1
	SAC-3P-100,0-PUR/0,34	1501650	1
	SAC-4P-100,0-PUR/0,25	1501692	1
	SAC-4P-100,0-PUR/0,34	1501663	1
4 x 0.34 mm ² , conductor colors: BN/WH/BU/BK	SAC-4P-100,0-PUR/0,34	1501663	1
5 x 0.34 mm ² , conductor colors: BN/WH/BU/BK/GN/YE	SAC-5P-100,0-PUR/0,34	1501676	1
6 x 0.25 mm ² , conductor colors: BN/WH/BU/BK/GY/PK	SAC-6P-100,0-PUR/0,25	1550614	1
8 x 0.25 mm ² , conductor colors: WH/BN/GN/YE/GY/PK/BU/RD	SAC-8P-100,0-PUR/0,25	1550630	1
PVC - black, cable type: PVC 3 x 0.25 mm ² , conductor colors: BN/BU/BK 3 x 0.34 mm ² , conductor colors: BN/BU/BK 4 x 0.25 mm ² , conductor colors: BN/WH/BU/BK 4 x 0.34 mm ² , conductor colors: BN/WH/BU/BK 5 x 0.34 mm ² , conductor colors: BN/WH/BU/BK/GN/YE 8 x 0.25 mm ² , conductor colors: WH/BN/GN/YE/GY/PK/BU/RD 12 x 0.14 mm ² , conductor colors: BN/BU/WH/GN/PK/YE/BK/GY/RD/VT/GYPK/RDBU 17 x 0.14 mm ² , conductor colors: BN/BU/WH/GN/PK/YE/BK/GY/RD/VT/GYPK/RDBU/WHGN/BNGN/WHYE/YEBN/WHGY PUR/PVC - black, twisted pair, cable type: 35T 12 x 0.14 mm ² , conductor colors: (BN/BU)/(WH/GN)/(PK/YE)/(BK/GY)/(RD/VT)/(GYPK/RDBU)	SAC-3P-100,0-PVC/0,25	1501854	1
	SAC-3P-100,0-PVC/0,34	1501825	1
	SAC-4P-100,0-PVC/0,25	1501867	1
	SAC-4P-100,0-PVC/0,34	1501838	1
	SAC-5P-100,0-PVC/0,34	1501841	1
	SAC-8P-100,0-PVC/0,25	1550698	1
	SAC-12P-100,0-PVC/0,14	1441532	1
	SAC-17P-100,0-PVC/0,14	1441545	1

Ordering example for cable drums with variable cable length:

For cable type: PVC - black, 5 x 0.34 mm², shielded, and 340 m in length, the ordering data is as follows:

Order No.	Length [m]
1408527	340
	Increment: 10 m; Min. length: 110 m Max. length: 500 m



Cable drum, 110 m to 500 m, unshielded



Cable ring, 100 m, shielded



Cable drum, 110 m to 500 m, shielded

Ordering data			Ordering data			Ordering data		
Type	Order No.	Pcs. / Pkt.	Type	Order No.	Pcs. / Pkt.	Type	Order No.	Pcs. / Pkt.
SAC-3P-PUR-0,25/...	1408505	1	SAC-3P-100,0-PUR/SH-0,25	1526525	1	SAC-3P-PUR-0,25-SH/...	1408511	1
SAC-3P-PUR-0,34/...	1408506	1	SAC-3P-100,0-PUR/SH-0,34	1501702	1	SAC-3P-PUR-0,34-SH/...	1408512	1
SAC-4P-PUR-0,25/...	1408507	1	SAC-4P-100,0-PUR/SH-0,25	1535794	1	SAC-4P-PUR-0,25-SH/...	1408513	1
SAC-4P-PUR-0,34/...	1408508	1	SAC-4P-100,0-PUR/SH-0,34	1501715	1	SAC-4P-PUR-0,34-SH/...	1408514	1
SAC-5P-PUR-0,34/...	1408509	1	SAC-5P-100,0-PUR/SH-0,34	1501728	1	SAC-5P-PUR-0,34-SH/...	1408515	1
SAC-8P-PUR-0,25/...	1408510	1	SAC-6P-100,0-PUR/SH-0,14	1550627	1	SAC-8P-PUR-0,25-SH/...	1408516	1
SAC-3P-PVC-0,25/...	1408518	1	SAC-3P-100,0-PVC/SH-0,34	1550656	1	SAC-3P-PVC-0,34-SH/...	1408525	1
SAC-3P-PVC-0,34/...	1408519	1	SAC-4P-100,0-PVC/SH-0,34	1550669	1	SAC-4P-PVC-0,34-SH/...	1408526	1
SAC-4P-PVC-0,25/...	1408521	1	SAC-5P-100,0-PVC/SH-0,34	1550672	1	SAC-5P-PVC-0,34-SH/...	1408527	1
SAC-4P-PVC-0,34/...	1408522	1	SAC-8P-100,0-PVC/SH-0,25	1550708	1	SAC-8P-PVC-0,25-SH/...	1408528	1
SAC-5P-PVC-0,34/...	1408523	1						
SAC-8P-PVC-0,25/...	1408524	1	SAC-12P-100,0-35T/SH-0,14	1405789	1			

Sensor/actuator cabling

By the meter

Cable rings for valve connector cables

The special SAC cables are also available in 100 m cable rings for connecting the valve connectors for assembly.

Cables between 110 m and 500 m in length are supplied on cable drums. Please refer to the ordering example below.

Notes:

For information about the cable qualities, see page 298



Cable ring, 100 m, unshielded



Cable drum, 110 m to 500 m, unshielded

Description	Ordering data			Ordering data		
	Type	Order No.	Pcs. / Pkt.	Type	Order No.	Pcs. / Pkt.
PUR, halogen-free - black, cable type: PUR 3 x 0.5 mm ² , conductor colors: BK 1/BK 2/GNYE	SAC-3P-100,0-PUR/0,5	1457393	1	SAC-3P-PUR-0,5/...	1408529	1
5 x 0.5 mm ² , conductor colors: BK 1/BK 2/BK 3/BK 4/GNYE	SAC-5P-100,0-PUR/0,5	1457403	1	SAC-5P-PUR-0,5/...	1408530	1
PVC - black, cable type: 534 3 x 0.75 mm ² , conductor colors: BK 1/BK 2/GNYE	SAC-3P-100,0-534/0,75	1457432	1			
5 x 0.75 mm ² , conductor colors: BK 1/BK 2/BK 3/BK 4/GNYE	SAC-5P-100,0-534/0,75	1457445	1			

Ordering example for cable drums with variable cable length:

For cable type: PUR, halogen-free - black, 5 x 0.5 mm², unshielded, and 340 m in length, the ordering data is as follows:

Order No.	Length [m]
1408530	340
	Increment: 10 m; Min. length: 110 m Max. length: 500 m

Master cable rings for sensor/actuator boxes

Master cable rings are available for distributor boxes with spring connection or plug-in screw connection. Similarly, master cables can also be connected to covers and M23 sockets for assembly.

Notes:

For information about the cable qualities, see page 312



Description	Ordering data		
	Type	Order No.	Pcs. / Pkt.
Master cable ring with PE conductor, PUR/PVC, unshielded, length: 50 m			
4 x 0.34 mm ² / 3 x 0.75 mm ²	SACB- 4X0,34/ 3X0,75-50,0 PUR	1503328	1
6 x 0.34 mm ² / 3 x 0.75 mm ²	SACB- 6X0,34/ 3X0,75-50,0 PUR	1503331	1
8 x 0.34 mm ² / 3 x 0.75 mm ²	SACB- 8X0,34/ 3X0,75-50,0 PUR	1503344	1
8 x 0.5 mm ² / 3 x 1.0 mm ²	SACB- 8X0,5/ 3X1,0-50,0 PUR	1503357	1
12 x 0.5 mm ² / 3 x 1.0 mm ²	SACB-12X0,5/ 3X1,0-50,0 PUR	1503360	1
16 x 0.5 mm ² / 3 x 1.0 mm ²	SACB-16X0,5/ 3X1,0-50,0 PUR	1503373	1
Master cable ring with PE conductor, PUR/PVC, unshielded, length: 200 m			
16 x 0.5 mm ² / 3 x 1.0 mm ²	SACB-16X0,5/ 3X1,0-200,0 PUR	1559893	1
Master cable ring with PE conductor, PUR/PVC, shielded, length: 50 m			
8 x 0.5 mm ² / 3 x 1.0 mm ²	SACB-8X0,5/3X1,0-50 PUR SH	1401240	1
12 x 0.5 mm ² / 3 x 1.0 mm ²	SACB-12X0,5/3X1,0-50 PUR SH	1401239	1
16 x 0.5 mm ² / 3 x 1.0 mm ²	SACB-16X0,5/3X1,0-50 PUR SH	1539156	1
Master cable ring with PE conductor, PUR/PP halogen-free, unshielded, length: 50 m			
8 x 0.5 mm ² / 3 x 1.0 mm ²	SACB-8X0,5/3X1,0-50,0 HPUR	1401690	1
16 x 0.5 mm ² / 3 x 1.0 mm ²	SACB-16X0,5/ 3X1,0-50,0 VPUR	1430938	1
Master cable ring with PE conductor, PUR/PP, halogen-free, highly flexible, unshielded, length: 50 m			
16 x 0.5 mm ² / 3 x 1.0 mm ²	SACB-16X0,5/ 3X1,0-50,0 80MC	1402304	1
Master cable ring without PE conductor, PUR/PVC, unshielded, length: 50 m			
4 x 0.34 mm ² / 2 x 0.75 mm ²	SACB- 4X0,34/2X0,75-50 PUR	1517576	1
6 x 0.34 mm ² / 2 x 0.75 mm ²	SACB- 6X0,34/2X0,75-50 PUR	1517589	1
8 x 0.34 mm ² / 2 x 0.75 mm ²	SACB- 8X0,34/2X0,75-50 PUR	1517592	1
10 x 0.34 mm ² / 2 x 0.75 mm ²	SACB-10X0,34/2X0,75-50 PUR	1517602	1
16 x 0.34 mm ² / 2 x 0.75 mm ²	SACB-16X0,34/2X0,75-50 PUR	1539350	1

Accessories

Assembly tools for sensor/actuator cables

The screwdriver with preset torque is the ideal tool for screwing in all M12 and M8 circular connectors with lengthwise knurl. The advantage of this tool becomes particularly evident when connecting distributor boxes. The tight arrangement and the large number of slots rarely makes it possible to install them correctly by hand. Thanks to the open design of the top unit, tracking is especially easy when screwing in.



Description	Ordering data		
	Type	Order No.	Pcs. / Pkt.
Torque screwdriver ① With preset torque of 0.2 Nm and 4 mm hexagonal drive	TSD 02 SAC	1208487	1
Nut ② For assembling sensor/actuator cables with M8 connectors and for M8 connectors with insulation displacement connection, for 4 mm hexagonal screwdriver	SAC BIT M8-D10	1208461	1
Nut ③ For assembling SACC M8 connectors with longitudinal knurl, excluding those with insulation displacement connection, for 4 mm hexagonal screwdriver	SACC BIT M8-D12	1208474	1
Torque screwdriver ④ With preset torque of 0.4 Nm and 4 mm hexagonal drive	TSD 04 SAC	1208429	1
Nut ⑤ For assembling sensor/actuator cables with M12 connectors and for M12 connectors with insulation displacement connection, for 4 mm hexagonal screwdriver	SAC BIT M12-D15	1208432	1
Nut ⑥ For assembling SACC M12 connectors, excluding those with insulation displacement connection, for 4 mm hexagonal screwdriver	SACC BIT M12-D20	1208445	1

Assembly tools for sensor/actuator cables

To achieve tight plug-in connections, we recommend using assembly tools. M12 and 7/8" circular connectors can be assembled using a torque screwdriver and plug attachment.

The benefits of the plug attachment become particularly clear when connecting the connectors to the distributor boxes. Thanks to the open design, it enables quick adjustment and installation even when space is at a premium.

The version for M12 connectors with hexagonal stainless steel knurl is also made from stainless steel. This prevents the connector knurls from being contaminated by corrosive materials.

For greater flexibility, screwdrivers with adjustable torque are also available. When used in conjunction with the adapter insert, they can also be used to accommodate the available plug attachments.

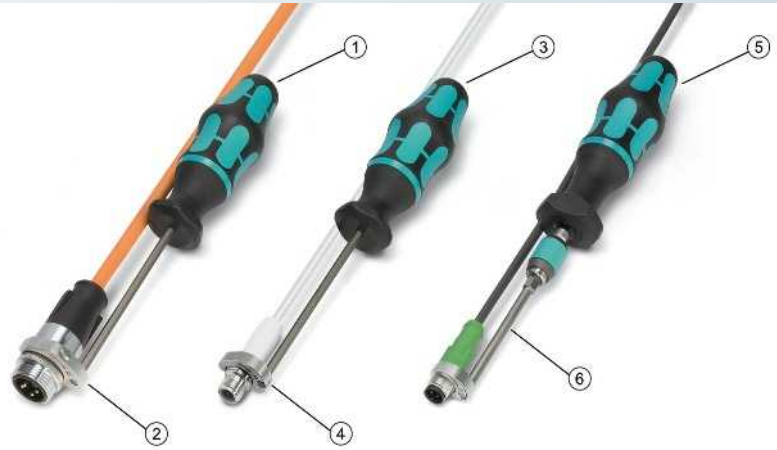

		Ordering data		
Description	Type	Order No.	Pcs. / Pkt.	
Torque screwdriver With a preset torque of 0.8 Nm and a 4 mm hexagonal drive	TSD 08 SAC	1212597	1	
Nut For assembling 7/8" connectors, with 4 mm hexagonal drive	SAC BIT MIN-D25	1212512	1	
Torque screwdriver With preset torque of 0.4 Nm and 4 mm hexagonal drive	TSD 04 SAC	1208429	1	
Nut For mounting M12 connectors with hexagonal stainless steel knurl, wrench size 14, with 4 mm hexagonal drive	SAC BIT M12-W14	1212513	1	
Torque screwdriver , accuracy according to standard EN ISO 6789 Adjustable from 0.3 - 1.2 Nm Adjustable from 1.2 - 3 Nm Adjustable from 3 - 6 Nm	TSD-M 1,2NM TSD-M 3NM TSD-M 6NM	1212224 1212225 1212226	1 1 1	
Adapter insert For torque screwdrivers with adjustable torque, for accommodating plug attachments with 4 mm hexagonal drive	TSD-M SAC-BIT ADAPTER	1212600	1	

Sealing elements

During transport or in the field, unoccupied plug-in connections must be protected or closed. Screw plugs, sealing caps and closing caps made of plastic or metal are suitable for this purpose. These achieve the IP65/IP67 as well as IP69K degrees of protection.



Description	Ordering data		
	Type	Order No.	Pcs. / Pkt.
M5 screw plug ① For unused M5 sockets of sensor/actuator cables, boxes, and device connectors	PROT-M5	1533288	10
M8 screw plug ② For unused M8 sockets of sensor/actuator cables, boxes, and device connectors	PROT-M8	1682540	5
M12 screw plug ③ For unused M12 sockets of sensor/actuator cables, boxes, and device connectors	PROT-M12	1680539	5
M12 screw plug with SPEEDCON quick locking ④ For unused M12 sockets of sensor/actuator cables, boxes, and device connectors	PROT-MS SCO	1553129	5
M12 sealing cap ⑤ For unused M12 connectors of sensor/actuator cables, device connectors, and I/O devices in the field	PROT-M12 FS	1560251	5
Screw plug M12, made of metal ⑥ For unused M12 sockets of shielded sensor/actuator cables, boxes, and device connectors	PROT-M12 SH	1503302	5
Metal M12 sealing cap ⑦ For unused M12 connectors of sensor/actuator cables, device connectors, and I/O devices in the field	PROT-M12 FS-M	1430488	10
M12 screw plug made of stainless steel ⑧ For unused M12 sockets of sensor/actuator cables, boxes, and device connectors in the food and outdoor range	PROT-M12 FB	1555538	5
Closing cap ⑨ For Pg9/Pg11, to close unoccupied connections	Q-PROT 9/11	1670235	10
M16 locking screw ⑩ With flat nut for oval housing cutouts	SACC-M16-SEALING PLUG SET	1453368	10

Sealing elements with holding band or fixing chain

All IP67 interfaces can be closed tightly using the screw plugs and sealing caps in the sizes M8, M12, and 7/8". The holding bands are fastened on the cable or the housing and are thus held captive.

The M12 metal protective cap with fixing chain is suitable for all pin versions. It is used in harsh industrial environments or for EMC applications.



Description	Ordering data		
	Type	Order No.	Pcs. / Pkt.
Screw plug made from plastic with retaining strap, for sealing unused sockets ①			
M8 for SAC cables	PROT-M 8 MS-PA-CHAIN	1430860	10
M8 with 3 mm fastening eye	PROT-M 8 MS-PA-CHAIN-EYE-DM3	1441105	10
M8 with 12 mm fastening eye	PROT-M 8 MS-PA-CHAIN-EYE	1441095	10
M12 for SAC cables	PROT-M12 MS-PA-CHAIN	1430899	5
M12 with 15 mm fastening eye	PROT-M12 MS-PA-CHAIN-EYE-DM14	1456200	5
7/8" for SAC cables	PROT-MINMS-PA-CHAIN	1430925	10
Plastic sealing cap with holding band, for closing unoccupied connectors ②			
M8 for SAC cables	PROT-M 8 FS-PA-CHAIN	1430857	10
M8 with 8 mm fastening eye	PROT-M 8 FS-PA-CHAIN-EYE	1441082	10
M12 for SAC cables	PROT-M12 FS-PA-CHAIN	1430873	5
M12 with 12 mm fastening eye	PROT-M12 FS-PA-CHAIN-EYE-DM12	1456187	5
M12 with 15 mm fastening eye	PROT-M12 FS-PA-CHAIN-EYE-DM14	1456190	5
7/8" for SAC cables	PROT-MINFS-PA-CHAIN	1430912	10
Sealing cap made of metal with fixing chain and 16 mm fastening eye, for sealing: ③			
Unused M12 connectors	PROT-M12 FS-M-CHAIN	1430491	10

Accessories

Accessories for M8 distributor boxes with plug-in master cable connection

The torque screwdriver with an M8 nut is the ideal tool for screwing in all M8 connectors with lengthwise knurl.

For distributors with 4 to 10 slots, we offer a suitable hood as replacement, a relevant screwdriver for fastening the hood as well as a torque screwdriver with a W24 nut for tightening the pressure nuts to a defined value.

The PROT M8 screw plug – for unoccupied slots – protects the distributors against foreign bodies and water. The IP65/67 degree of protection is attained.

The slots can be marked using the marking material. They can be marked either by hand or using a plotter.



Notes:
Additional marking material and tools can be found in Catalog 5.

		Ordering data		
Description	Type	Order No.	Pcs. / Pkt.	
Sensor/actuator connector hood , with marking label, for sensor/actuator box with:				
4 single-occupancy M8 slots	SACB-C-H180- 4/3-M8	1521229	1	
6 single-occupancy M8 slots	SACB-C-H180- 6/3-M8	1521216	1	
8 single-occupancy M8 slots	SACB-C-H180- 8/3-M8	1516425	1	
Ten single-occupancy M8 slots	SACB-C-H180-10/3-M8	1516412	1	
M8 screw plug	PROT-M8	1682540	5	
For unused M8 sockets of sensor/actuator cables, boxes, and device connectors				
Marking material , 10-section				
- Unprinted	ZBF10:UNBEDRUCKT	0809997	10	
- Configurable	ZBF10 CUS	0825031	1	
Torque screwdriver	TSD 02 SAC	1208487	1	
With preset torque of 0.2 Nm and 4 mm hexagonal drive				
Nut	SAC BIT M8-D10	1208461	1	
For assembling sensor/actuator cables with M8 connectors and for M8 connectors with insulation displacement connection, for 4 mm hexagonal screwdriver				
Nut	SACC BIT M8-D12	1208474	1	
For assembling SACC M8 connectors with longitudinal knurl, excluding those with insulation displacement connection, for 4 mm hexagonal screwdriver				
Screwdriver	SZK PZ2 VDE	1206463	10	
Size: PZ2 x 100 mm, length: 205 mm				
Torque screwdriver	TSD 25 SAC	1212315	1	
With a preset torque of 2.5 Nm and 4 mm hexagonal drive				
Nut	SAC BIT HOOD-W 24	1212486	1	
For reliable tightening of the pressure nuts with a wrench size of 24 mm, for 4 mm hexagonal screwdriver				

Accessories for M8 distributor boxes with M12/M16 plug-in connection

Suitable sockets in an angled design with a 5 and 10 meter master cable are available for distributors with 4 to 10 slots. In order to use a master cable as per the specific requirements, sockets are available in straight and angled designs for free assembly.

The slots can be marked using the marking material. They can be marked either by hand or using a plotter.

The torque screwdriver with matching nuts is the ideal tool for screwing together all M8 connectors with lengthwise knurl.

The PROT M8 screw plug – for unoccupied slots – protects the distributors against foreign bodies and water. The IP65/67 degree of protection is attained.



Notes:
Additional marking material and tools can be found in Catalog 5.

Description	
M16 socket , angled, with a master cable, for sensor/actuator box with:	①
4 slots, cable length: 5 m	
4 slots, cable length: 10 m	
6 slots, cable length: 5 m	
6 slots, cable length: 10 m	
8 slots, cable length: 5 m	
8 slots, cable length: 10 m	
10 slots, cable length: 5 m	
10 slots, cable length: 10 m	
M12 socket , angled, with connected master cable, for sensor/actuator box with:	②
4 slots, cable length: 5 m	
4 slots, cable length: 10 m	
4 slots, cable length: variable	
6 slots, cable length: 5 m	
6 slots, cable length: 10 m	
6 slots, cable length: variable	
M16 socket , 14-pos., straight, freely configurable, with solder connection, for an external cable diameter of 6.0 mm ... 8.0 mm	③
M16 socket , 14-pos., angled, freely configurable, with solder connection, for an external cable diameter of 6.0 mm ... 8.0 mm	④
M8 screw plug For unused M8 sockets of sensor/actuator cables, boxes, and device connectors	⑤
Marking material , 10-section - Unprinted - Configurable	⑥
Torque screwdriver With preset torque of 0.2 Nm and 4 mm hexagonal drive	⑦
Nut For assembling sensor/actuator cables with M8 connectors and for M8 connectors with insulation displacement connection, for 4 mm hexagonal screwdriver	⑧
Nut For assembling SACC M8 connectors with longitudinal knurl, excluding those with insulation displacement connection, for 4 mm hexagonal screwdriver	⑨

Ordering data		
Type	Order No.	Pcs. / Pkt.
SAC-8P- 5,0-PUR/M16FR	1693681	1
SAC-8P-10,0-PUR/M16FR	1693694	1
SAC-10P- 5,0-PUR/M16FR	1693704	1
SAC-10P-10,0-PUR/M16FR	1693717	1
SAC-12P- 5,0-PUR/M16FR	1693720	1
SAC-12P-10,0-PUR/M16FR	1693733	1
SAC-14P- 5,0-PUR/M16FR	1693746	1
SAC-14P-10,0-PUR/M16FR	1693759	1
SAC-6P- 5,0-PURMC/M12FR	1407820	1
SAC-6P-10,0-PURMC/M12FR	1407821	1
SAC-6P-M12FR-PURMC/	1520987	1
SAC-8P- 5,0-PURMC/M12FR	1407822	1
SAC-8P-10,0-PURMC/M12FR	1407823	1
SAC-8P-M12FR-PURMC/	1520990	1
SACC-M16FS-14CON-M	1500554	1
SACC-M16FR-14CON-M	1500253	1
PROT-M8	1682540	5
ZBF10:UNBEDRUCKT	0809997	10
ZBF10 CUS	0825031	1
TSD 02 SAC	1208487	1
SAC BIT M8-D10	1208461	1
SACC BIT M8-D12	1208474	1

Ordering example for socket with variable master cable:

For an M12 socket for 4 slots and a master cable length of 15 m, the ordering data is as follows:

Order No.	Length [m] Max. 40 m
1520987	15.0
	Increments: 0.2 ... 3 m = 0.1 m > 3 m = 0.5 m

Accessories

Accessories for M12 distributor boxes with plastic thread and connector hood

The torque screwdriver with an M12 nut is the ideal tool for screwing in all M12 connectors with lengthwise knurl.

For the distributors, we offer a suitable hood as replacement, a matching screwdriver for fastening the hood as well as a torque screwdriver with a V24 nut for tightening the pressure nuts to a defined value.

The PROT-MS SCO screw plug – for unoccupied slots – protects the distributors against foreign bodies and water. The IP65/67 degree of protection is attained.

The slots can be marked using the marking material. They can be marked either by hand or using a plotter.



Notes:
Additional marking material and tools can be found in Catalog 5.

		Ordering data		
Description	Type	Order No.	Pcs. / Pkt.	
Connector hood with integrated connector , for M12 sensor/actuator boxes with plastic thread and plug-in screw connection, for 4, 6 or 8 slots				①
M12 screw plug with SPEEDCON quick locking	SACB-C-H180-8/16 SCO P	1453229	1	②
For unused M12 sockets of sensor/actuator cables, boxes, and device connectors	PROT-MS SCO	1553129	5	
Marking material , 5-section				③
- Unprinted, white	SS-ZB 17,5 WH	0804963	50	
- Unprinted, yellow	SS-ZB 17,5 YE	0804976	50	
- Configurable, white	SS-ZB 17,5 WH CUS	0824468	1	
- Configurable, yellow	SS-ZB 17,5 YE CUS	0824469	1	
Torque screwdriver				④
With preset torque of 0.4 Nm and 4 mm hexagonal drive	TSD 04 SAC	1208429	1	
Nut				⑤
For assembling sensor/actuator cables with M12 connectors and for M12 connectors with insulation displacement connection, for 4 mm hexagonal screwdriver	SAC BIT M12-D15	1208432	1	
Nut				⑥
For assembling SACC M12 connectors, excluding those with insulation displacement connection, for 4 mm hexagonal screwdriver	SACC BIT M12-D20	1208445	1	
Screwdriver				⑦
Size: PZ2 x 100 mm, length: 205 mm	SZK PZ2 VDE	1206463	10	
Torque screwdriver				⑧
With a preset torque of 2.5 Nm and 4 mm hexagonal drive	TSD 25 SAC	1212315	1	
Nut				⑨
For reliable tightening of the pressure nuts with a wrench size of 24 mm, for 4 mm hexagonal screwdriver	SAC BIT HOOD-W 24	1212486	1	
Screwdriver , suitable for all screw terminal blocks up to 1.5 mm ² connection cross section, without VDE approval				⑩
Blade: 0.4 x 2.0 x 60 mm, length: 157 mm	SZS 0,4X2,0	1205202	10	
Ferrules , without plastic sleeves, CSA-certified				⑪
0.5 mm ²	A 0,5 - 6	3200218	1000	
0.75 mm ²	A 0,75-10	3200234	1000	
1.0 mm ²	A 1 -10	3200250	1000	
1.5 mm ²	A 1,5 -10	3200276	1000	

Accessories for M12 distributor boxes with metal thread and plug-in screw connection

The torque screwdriver with an M12 nut is the ideal tool for screwing in all M12 connectors with lengthwise knurl.

For the distributors, we offer a suitable hood as replacement, a matching screwdriver for fastening the hood as well as a torque screwdriver with a W24 nut for tightening the pressure nuts to a defined value.

The PROT-MS SCO screw plug – for unoccupied slots – protects the distributors against foreign bodies and water. The IP65/67 degree of protection is attained.

The slots can be marked using the marking material. They can be marked either by hand or using a plotter.



Notes:

Additional marking material and tools can be found in Catalog 5.

Description	
Connector hood with integrated connector, for M12 sensor/actuator boxes with metal thread and plug-in screw connection, for 4, 6 or 8 slots	①
M12 screw plug with SPEEDCON quick locking	②
For unused M12 sockets of sensor/actuator cables, boxes, and device connectors	
Marking material , 5-section	③
- Unprinted, white - Unprinted, yellow - Configurable, white - Configurable, yellow	
Torque screwdriver	④
With preset torque of 0.4 Nm and 4 mm hexagonal drive	
Nut	⑤
For assembling sensor/actuator cables with M12 connectors and for M12 connectors with insulation displacement connection, for 4 mm hexagonal screwdriver	
Nut	⑥
For assembling SACC M12 connectors, excluding those with insulation displacement connection, for 4 mm hexagonal screwdriver	
Screwdriver	⑦
Size: PZ1 x 80 mm, length: 178 mm	
Torque screwdriver	⑧
With a preset torque of 2.5 Nm and 4 mm hexagonal drive	
Nut	⑨
For reliable tightening of the pressure nuts with a wrench size of 24 mm, for 4 mm hexagonal screwdriver	

Ordering data

Type	Order No.	Pcs. / Pkt.
SACB-C-H180 8/16 SCO	1516713	10
PROT-MS SCO	1553129	5
SS-ZB 17,5 WH	0804963	50
SS-ZB 17,5 YE	0804976	50
SS-ZB 17,5 WH CUS	0824468	1
SS-ZB 17,5 YE CUS	0824469	1
TSD 04 SAC	1208429	1
SAC BIT M12-D15	1208432	1
SACC BIT M12-D20	1208445	1
SZK PZ1 VDE	1206450	10
TSD 25 SAC	1212315	1
SAC BIT HOOD-W 24	1212486	1

Accessories

Accessories for shielded M12 distributor boxes

For the distributors, suitable shielded sockets are available in angled design with a pre-assembled master cable. Further accessories include straight and angled M23 sockets for free assembly.

The PROT M12 SH screw plug – for unoccupied slots – protects the distributors against foreign bodies and water. The IP65/67 degree of protection is attained.

The slots can be marked using the marking material. They can be marked either by hand or using a plotter.

The torque screwdriver with matching nuts is the ideal tool for screwing together all M12 connectors with lengthwise knurl.



Notes:
Additional marking material and tools can be found in Catalog 5.

		Ordering data		
Description	Type	Order No.	Pcs. / Pkt.	
Socket M23 , 19-pos., angled, shielded, with connected master cable ①				
Conductor length: 5 m	RCK-TWGM/BL16+3/ 5,0PUR SH	1519529	1	
Conductor length: 10 m	RCK-TWGM/BL16+3/10,0PUR SH	1511828	1	
M23 socket , 19-pos., angled, shielded, freely configurable, with solder connection, for cable Ø: 9.5 mm ... 14.5 mm ②				
	RC/TGGM/KVD/LBL 16+3	1685505	1	
M23 socket , 19-pos., angled, shielded, freely configurable, with solder connection, for cable Ø: 9.5 mm ... 14.5 mm ③				
	RC/TWGM/KVD/LBL 16+3	1685518	1	
Special pipe spanner ④	PLUSCON-RCS	1665062	1	
Auxiliary tool for mounting the M23 connector housing that can be assembled				
Screw plug M12, made of metal ⑤	PROT-M12 SH	1503302	5	
for unused M12 sockets of shielded sensor/actuator cables, boxes, and device connectors				
M23 sealing cap made of metal , for unoccupied M23 connectors ⑥	MSK 1	1665897	10	
- without steel wire	MSK 2	1665907	1	
- with steel wire				
Sealing cap made of plastic , for unoccupied M23 connectors ⑦	KSK 1	1685013	10	
Marking material ⑧	ZBN 18:UNBEDRUCKT	2809128	10	
- Unprinted, white	UC-TMF 16 YE	0819259	10	
- Unprinted, yellow	ZBN 18 CUS	0825059	1	
- Configurable, white	ZBN 18 YE CUS	0825058	1	
- Configurable, yellow				
Torque screwdriver ⑨	TSD 04 SAC	1208429	1	
With preset torque of 0.4 Nm and 4 mm hexagonal drive				
Nut ⑩	SAC BIT M12-D15	1208432	1	
For assembling sensor/actuator cables with M12 connectors and for M12 connectors with insulation displacement connection, for 4 mm hexagonal screwdriver				
Nut ⑪	SACC BIT M12-D20	1208445	1	
For assembling SACC M12 connectors, excluding those with insulation displacement connection, for 4 mm hexagonal screwdriver				

Accessories for QUICKON distributor boxes with a connection cross section of 0.14 mm² ... 0.34 mm²

The Q-PROT 9/11 closing cap – for unoccupied slots – protects the distributors against foreign bodies and water. The IP65/67 degree of protection is attained.

A torque screwdriver with a W13 nut, already familiar from M8 or M12 screw connections, is now also available for the fast connection pressure nuts. The handling of the tools is self-explanatory and easy.

For the distributors, we offer a replacement plug hood, a relevant screwdriver for fastening the hood as well as a torque screwdriver with a W24 nut for tightening the pressure nuts to a defined value.

The slots can be marked using the marking material. They can be marked either by hand or using a plotter.

The QUICKON set comprising a splice ring, a pressure nut, and a line seal serves for replacement purposes if necessary.



Notes:

Additional marking material and tools can be found in Catalog 5.

Description	
Connector hood with an integrated connector, for sensor/actuator boxes with QUICKON fast connection technology and plug-in screw connection, for 4, 6 or 8 slots	①
Closing cap for Pg9/Pg11, to close unoccupied connections	②
Marking material , 5-section - Unprinted, white - Unprinted, yellow - Configurable, white - Configurable, yellow	③
QUICKON set for replacement purposes, consisting of splice ring, pressure nut, and conductor seal	④
Screwdriver Size: PZ1 x 80 mm, length: 178 mm	⑤
Torque screwdriver With a preset torque of 2.0 Nm and 4 mm hexagonal drive	⑥
Nut For the reliable tightening of the pressure nuts with a wrench size of 13 mm, for 4 mm hexagonal screwdriver	⑦
Torque screwdriver With a preset torque of 2.5 Nm and 4 mm hexagonal drive	⑧
Nut For reliable tightening of the pressure nuts with a wrench size of 24 mm, for 4 mm hexagonal screwdriver	⑨

Ordering data		
Type	Order No.	Pcs. / Pkt.
SACB-C-H180 8/4 QO-0,34	1560235	1
Q-PROT 9/11	1670235	10
SS-ZB 17,5 WH	0804963	50
SS-ZB 17,5 YE	0804976	50
SS-ZB 17,5 WH CUS	0824468	1
SS-ZB 17,5 YE CUS	0824469	1
QO-SET	1548626	20
SZK PZ1 VDE	1206450	10
TSD 20 SAC	1212020	1
SAC BIT QUICKON-W13	1212033	1
TSD 25 SAC	1212315	1
SAC BIT HOOD-W 24	1212486	1

Sensor/actuator cabling

Accessories

Accessories for QUICKON distributor boxes with a connection cross section of 0.34 mm² ... 0.75 mm²

The scope of supply of the distributors includes a black rubber seal for an external cable diameter from 6.5 mm to 9.5 mm. Rubber seals are also available from 4.0 mm to 6.5 mm (yellow seal) or 9.0 mm to 13.0 mm (red seal) master cables. The torque screwdriver with a W24 nut is suitable for tightening the pressure nuts to a defined value.

The QUICKON set comprising a pressure nut, a cap, a line seal, and a splice ring serves for replacement purposes if necessary.

The socket wrench facilitates comfortable loosening or tightening of the QUICKON pressure nuts.

The Q-PROT 9/11 closing cap – for unoccupied slots – protects the distributors against foreign bodies and water. The IP65/67 degree of protection is attained.

The slots can be marked using the marking material. They can be marked either by hand or using a plotter.

Notes:
Additional marking material and tools can be found in Catalog 5.















Description	Ordering data			
	Type	Order No.	Pcs. / Pkt.	
Rubber seal for Pg13.5 screw connection for cable Ø: 4.0 mm ... 6.5 mm	①	SACB-D PG 13,5 (4,0-6,5) YE	1680377	10
Rubber seal for Pg13.5 screw connection For cable Ø: 6.5 mm ... 9.5 mm	②	SACB-D PG 13,5 (6,5-9,5) BK	1680380	10
Rubber seal for Pg13.5 screw connection For cable Ø: 9.0 mm ... 13.0 mm	③	SACB-D PG 13,5 (9,0-13,0) RD	1680393	10
Closing cap For Pg9/ Pg11, to close unoccupied connections	④	Q-PROT 9/11	1670235	10
Marking material	⑤	ZBN 18:UNBEDRUCKT	2809128	10
- Unprinted, white		UC-TMF 16 YE	0819259	10
- Unprinted, yellow		ZBN 18 CUS	0825059	1
- Configurable, white		ZBN 18 YE CUS	0825058	1
- Configurable, yellow				
QUICKON set for replacement purposes, consisting of pressure nut, cap, conductor seal, and splice ring	⑥	Q SET-11/4 COD1 SACB-Q	1670743	25
Screwdriver Size: PZ1 x 80 mm, length: 178 mm	⑦	SZK PZ1 VDE	1206450	10
Slotted socket wrench for QUICKON nuts and panel feed-throughs, for wrench size: 22 mm	⑧	QSS 22	1670206	1
Torque screwdriver With a preset torque of 2.5 Nm and 4 mm hexagonal drive	⑨	TSD 25 SAC	1212315	1
Nut For reliable tightening of the pressure nuts with a wrench size of 24 mm, for 4 mm hexagonal screwdriver	⑩	SAC BIT HOOD-W 24	1212486	1

Sensor/actuator cabling

Sensor/actuator cable - cable range

Symbol key

	With UL Style		Suitable for drag chain applications		Resistant to welding sparks
	UV resistant		Flame-retardant		High temperature resistance
	Good oil resistance		Good resistance to chemicals		Suitable for torsional stress
	Halogen-free		Suitable for the food industry		Suitable for railway applications

PUR, halogen-free – PHOENIX CONTACT standard



Permanently flexible control cables for use in drag chains, revolving/swivel tables, and as machine control cables for extreme operating conditions. Suitable for bending cycle loads with long-term durability. The special PUR outer sheath offers excellent resistance to oils according to DIN EN 60811-2-1, lubricants, cooling agents, and other aggressive substances.

Additional features: halogen and PVC-free, no silicone or substances that would hinder coating with paint or varnish, resistant to hydrolysis and flame-retardant according to UL-FT2.

Outer sheath material	PUR
Min. bending cycles	4 million
Minimum bending radius	10 x D
Traverse path	10 m
Acceleration	10 m/s²
Speed	3 m/s
Tested at	+20°C ... +25°C





Type	Number of positions	Use	Structure	Cross section	Wire colors	Wire insulation	Temperature range	Page
PUR Black	3-pos.	M8	3 x 0.25 mm ² (32 x 0.1 mm)		Brown, blue, black	PP	Mobile: -25°C ... +80°C Fixed: -40°C ... +80°C	172 234 236 282
		M8 Shielded	3 x 0.25 mm ² (32 x 0.1 mm) Shielding: copper braid		Brown, blue, black	PP	Mobile: -25°C ... +80°C Fixed: -40°C ... +80°C	179 282
		M12	3 x 0.34 mm ² (42 x 0.1 mm)		Brown, blue, black	PP	Mobile: -25°C ... +80°C Fixed: -40°C ... +80°C	172 236 282
		M12 Shielded	3 x 0.34 mm ² (42 x 0.1 mm) Shielding: copper braid		Brown, blue, black	PP	Mobile: -25°C ... +80°C Fixed: -40°C ... +80°C	179
		Valve connectors	3 x 0.5 mm ² (28 x 0.15 mm)		Black 1, black 2, green-yellow	PP	Mobile: -15°C ... +80°C Fixed: -40°C ... +80°C	216 to 224 284

Type	Number of positions	Use	Structure	Cross section	Wire colors	Wire insulation	Temperature range	Page
PUR Black	4-pos.	M8	4 x 0.25 mm ² (32 x 0.1 mm)		Brown, white, blue, black	PP	Mobile: -25°C ... +80°C Fixed: -40°C ... +80°C	172 180 282
		M8 Shielded	4 x 0.25 mm ² (32 x 0.1 mm) Shielding: copper braid		Brown, white, blue, black	PP	Mobile: -25°C ... +80°C Fixed: -40°C ... +80°C	185 282
		M12	4 x 0.34 mm ² (42 x 0.1 mm)		Brown, white, blue, black	PP	Mobile: -25°C ... +80°C Fixed: -40°C ... +80°C	180 235 282
		M12 Shielded	4 x 0.34 mm ² (42 x 0.1 mm) Shielding: copper braid		Brown, white, blue, black	PP	Mobile: -25°C ... +80°C Fixed: -40°C ... +80°C	185 282
		M12 power	4 x 1.5 mm ² (84 x 0.15 mm)		Brown, white, blue, black	PP	Mobile: -30°C ... +90°C Fixed: -40°C ... +90°C	274
		M12 power	4 x 1.5 mm ² (84 x 0.15 mm)		Black 1, black 2, black 3, green-yellow	PP	Mobile: -30°C ... +90°C Fixed: -40°C ... +90°C	272
		M12 power Shielded	4 x 1.5 mm ² (78 x 0.15 mm) Shielding: copper braid		Brown, white, blue, black	PP	Mobile: -30°C ... +90°C Fixed: -40°C ... +90°C	275
		Valve connectors	4 x 0.5 mm ² (28 x 0.15 mm)		Black 1, black 2, black 3, green-yellow	PP	Mobile: -20°C ... +80°C Fixed: -40°C ... +80°C	216 to 224
	5-pos.	M12	5 x 0.34 mm ² (42 x 0.1 mm)		Brown, white, blue, black, green-yellow	PP	Mobile: -25°C ... +80°C Fixed: -40°C ... +80°C	187 282
		M12 Shielded	5 x 0.34 mm ² (42 x 0.1 mm) Shielding: copper braid		Brown, white, blue, black, gray	PP	Mobile: -25°C ... +80°C Fixed: -40°C ... +80°C	190 282
		Valve connectors	5 x 0.5 mm ² (28 x 0.15 mm)		Black 1, black 2, black 3, black 4, green-yellow	PP	Mobile: -15°C ... +80°C Fixed: -40°C ... +80°C	228 284
	6-pos.	M8	6 x 0.25 mm ² (32 x 0.1 mm)		Brown, white, blue, black, gray, pink	PP	Mobile: -25°C ... +80°C Fixed: -40°C ... +80°C	191 282

Sensor/actuator cabling

Sensor/actuator cable - cable range

Type	Number of positions	Use	Structure	Cross section	Wire colors	Wire insulation	Temperature range	Page
PUR Black	6-pos.	M8 Shielded	6 x 0.14 mm ² (18 x 0.1 mm) Shielding: copper braid		Brown, white, blue, black, gray, pink	PP	Mobile: -25°C ... +80°C Fixed: -40°C ... +80°C	192 282
	8-pos.	M8	8 x 0.14 mm ² (18 x 0.1 mm)		According to DIN 47100	PP	Mobile: -25°C ... +80°C Fixed: -40°C ... +80°C	193
		M8 Shielded	8 x 0.14 mm ² (18 x 0.1 mm) Shielding: copper braid		According to DIN 47100	PP	Mobile: -25°C ... +80°C Fixed: -40°C ... +80°C	196
		M12	8 x 0.25 mm ² (32 x 0.1 mm)		According to DIN 47100	PP	Mobile: -25°C ... +80°C Fixed: -40°C ... +80°C	194 282
		M12 Shielded	8 x 0.25 mm ² (32 x 0.1 mm) Shielding: copper braid		According to DIN 47100	PP	Mobile: -25°C ... +80°C Fixed: -40°C ... +80°C	197 282
		12-pos.	M12	12 x 0.14 mm ² (18 x 0.1 mm)		According to DIN 47100	PP	Mobile: -20°C ... +80°C Fixed: -40°C ... +80°C
	17-pos.	M12	17 x 0.14 mm ² (18 x 0.1 mm)		According to DIN 47100	PP	Mobile: -20°C ... +80°C Fixed: -40°C ... +80°C	198
PUR Orange	4-pos.	M12 power Shielded	4 x 1.5 mm ² (78 x 0.15 mm) Shielding: copper braid		Black 1, black 2, black 3, green-yellow	PP	Mobile: -30°C ... +90°C Fixed: -40°C ... +90°C	273
115 Black	5-pos.	M8	5 x 0.25 mm ² (32 x 0.1 mm)		Brown, white, blue, black, gray	PP	Mobile: -25°C ... +80°C Fixed: -40°C ... +80°C	186
		M12	5 x 0.34 mm ² (42 x 0.1 mm)		Brown, white, blue, black, gray	PP	Mobile: -25°C ... +80°C Fixed: -40°C ... +80°C	187
121 Black	3-pos.	Valve connectors	3 x 1.0 mm ² (32 x 0.20 mm)		Black 1, black 2, green-yellow	PP	Mobile: -20°C ... +80°C Fixed: -40°C ... +80°C	216 218
240 Yellow	3-pos.	Valve connectors	3 x 0.5 mm ² (28 x 0.15 mm)		Black 1, black 2, green-yellow	PP	Mobile: -15°C ... +80°C Fixed: -40°C ... +80°C	216 to 224

Type	Number of positions	Use	Structure	Cross section	Wire colors	Wire insulation	Temperature range	Page
240 Yellow	4-pos.	M12	4 x 0.34 mm ² (42 x 0.1 mm)		Brown, white, blue, black	PP	Mobile: -25°C ... +80°C Fixed: -40°C ... +80°C	180
	5-pos.	Valve connectors	5 x 0.5 mm ² (28 x 0.15 mm)		Black 1, black 2, black 3, black 4, green-yellow	PP	Mobile: -15°C ... +80°C Fixed: -40°C ... +80°C	216 to 224
280 Gray	3-pos.	M8	3 x 0.25 mm ² (32 x 0.1 mm)		Brown, blue, black	PP	Mobile: -25°C ... +80°C Fixed: -40°C ... +80°C	172 174 236
		M12	3 x 0.34 mm ² (42 x 0.1 mm)		Brown, blue, black	PP	Mobile: -25°C ... +80°C Fixed: -40°C ... +80°C	174 236
		Valve connectors	3 x 0.5 mm ² (28 x 0.15 mm)		Black 1, black 2, green-yellow	PP	Mobile: -15°C ... +80°C Fixed: -40°C ... +80°C	216 to 224
	4-pos.	M12	4 x 0.34 mm ² (42 x 0.1 mm)		Brown, white, blue, black	PP	Mobile: -25°C ... +80°C Fixed: -40°C ... +80°C	180
	5-pos.	Valve connectors	5 x 0.5 mm ² (28 x 0.15 mm)		Black 1, black 2, black 3, black 4, green-yellow	PP	Mobile: -15°C ... +80°C Fixed: -40°C ... +80°C	228
	8-pos.	M12 Shielded	8 x 0.25 mm ² (32 x 0.1 mm) Shielding: copper braid		According to DIN 47100	PP	Mobile: -25°C ... +80°C Fixed: -40°C ... +80°C	197

TPE-U highly flexible



Permanently flexible control cable that is ideal for use in drag chains and industrial robots. The cable can be used wherever extreme bending and torsional stress occur simultaneously and significantly longer durability is desired. It is resistant to welding sparks and is therefore designed exclusively for use in resistance welding processes. The use of new materials eliminates irradiation cross-linking, which makes the cable easier to recycle. The cables therefore meet the requirements of DIN EN ISO 14001. Additional features: halogen and PVC-free, flame-retardant according to UL-FT1, VW1, and 1581 §1061, very good resistance to oils

according to VDE 0250 Part 407, chemicals, lubricants, and coolants as well as other aggressive substances.

Due to the extremely robust outer sheath, this cable should only be stripped in 5 cm increments.

Outer sheath material	TPE-U
Min. bending cycles	10 million
Minimum bending radius	
Fixed	5 x D
Mobile	7.5 x D
Traversal path	5 m
Acceleration	20 m/s²
Speed	3.33 m/s
Torsion angle	±360°
Min. torsion cycles	13 million
Tested at	+20°C ... +25°C

Type	Number of positions	Use	Structure	Cross section	Wire colors	Wire insulation	Temperature range	Page	
800 Gray	3-pos.	M8	3 x 0.25 mm ² (32 x 0.1 mm)		Brown, blue, black	Polyester	Mobile: -30°C ... +90°C Fixed: -40°C ... +90°C 120°C ... 3000 h	172 174 236	
		M12	3 x 0.34 mm ² (42 x 0.1 mm)		Brown, blue, black	Polyester	Mobile: -30°C ... +90°C Fixed: -40°C ... +90°C 120°C ... 3000 h	174 236 178	
	4-pos.	M8	4 x 0.25 mm ² (32 x 0.1 mm)		Brown, white, blue, black	Polyester	Mobile: -30°C ... +90°C Fixed: -40°C ... +90°C 120°C ... 3000 h	172 180	
		M12	4 x 0.34 mm ² (42 x 0.1 mm)		Brown, white, blue, black	Polyester	Mobile: -30°C ... +90°C Fixed: -40°C ... +90°C 120°C ... 3000 h	180 184	
	5-pos.	M12	5 x 0.34 mm ² (42 x 0.1 mm)		Brown, white, blue, black, gray	Polyester	Mobile: -30°C ... +90°C Fixed: -40°C ... +90°C 120°C ... 3000 h	187	
	8-pos.	M12	8 x 0.25 mm ² (32 x 0.1 mm)		According to DIN 47100	Polyester	Mobile: -30°C ... +90°C Fixed: -40°C ... +90°C 120°C ... 3000 h	194	
	802 Gray	5-pos.	M12	5 x 0.34 mm ² (42 x 0.1 mm)		Brown, white, blue, black, green-yellow	Polyester	Mobile: -30°C ... +90°C Fixed: -40°C ... +90°C 120°C ... 3000 h	189

PUR irradiated, resistant to welding sparks

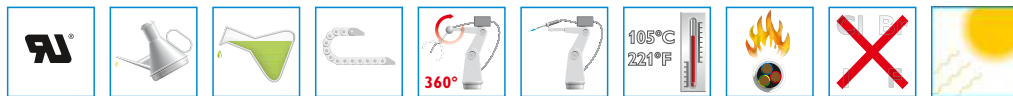

Due to the irradiation of the PUR outer sheath, the properties typical of PUR, e.g., resistance to temperature, UV, and welding sparks, are greatly improved. The cables are suitable for robust use in robot technology, particularly in welding robots, and are characterized by very long durability. Flame-retardant according to DIN VDE 0472, Part 804, test type B.

Outer sheath material	PUR irradiated
Min. bending cycles	5 million
Minimum bending radius	10 x D
Traverse path	10 m
Acceleration	10 m/s²
Speed	3 m/s
Torsion	±360°
Tested at	+20°C ... +25°C

Type	Number of positions	Use	Structure	Cross section	Wire colors	Wire insulation	Temperature range	Page
150 Orange	3-pos.	M12	3 x 0.34 mm ² (42 x 0.1 mm)		Brown, blue, black	Halogen-free polyester-based plastic	Mobile: -40°C ... +105°C Fixed: -50°C ... +105°C	174 236
		Valve connectors	3 x 0.5 mm ² (28 x 0.15 mm)		Black 1, black 2, green-yellow	Halogen-free polyester-based plastic	Mobile: -40°C ... +105°C Fixed: -50°C ... +105°C	216 to 224
	4-pos.	M12	4 x 0.34 mm ² (42 x 0.1 mm)		Brown, white, blue, black	Halogen-free polyester-based plastic	Mobile: -40°C ... +105°C Fixed: -50°C ... +105°C	180
		M12	4 x 0.34 mm ² + 1 x 0.5 mm ² (42 x 0.1 mm, 24 x 0.15 mm)		Brown, white, blue, black, green-yellow	Halogen-free polyester-based plastic	Mobile: -40°C ... +105°C Fixed: -50°C ... +105°C	187
		Valve connectors	5 x 0.5 mm ² (28 x 0.15 mm)		Black 1, black 2, black 3, black 4, green-yellow	Halogen-free polyester-based plastic	Mobile: -40°C ... +105°C Fixed: -50°C ... +105°C	228
160 Yellow	4-pos.	M12	4 x 0.34 mm ² (42 x 0.1 mm)		Brown, white, blue, black	Halogen-free polyester-based plastic	Mobile: -40°C ... +105°C Fixed: -50°C ... +105°C	180

Sensor/actuator cabling

Sensor/actuator cable - cable range

PUR/PVC (also applies to type PUR for M5 connectors)



The cables are designed for robust use in machine tools, assembly/production lines, as well as production involving metal cutting. They are free from silicone and substances that would hinder coating with paint or varnish and have a high resistance to abrasion. The outer sheath also offers excellent resistance to oil and chemicals according to DIN EN 60811-2-1 and is

flame-retardant according to DIN EN 50265. The outer sheath is manufactured using the coextrusion process.

Outer sheath material	PUR
Inner sheath material	PVC
Min. bending cycles	2 million
Minimum bending radius	10 x D
Traverse path	5 m
For type 35T	10 m
Acceleration	5 m/s²
For type 35T	10 m/s²
Speed	3 m/s
Tested at	+20°C ... +25°C

Type	Number of positions	Use	Structure	Cross section	Wire colors	Wire insulation	Temperature range	Page
35T Black Twisted pair	12-pos.	M12 Shielded	6 x 2 x 0.14 mm ² (18 x 0.1 mm) Shielding: copper braid		According to DIN 47100	PVC	Mobile: -5°C ... +80°C Fixed: -40°C ... +80°C	200
	17-pos.	M12 Shielded	7 x 2 x 0.14 mm ² 1 x 3 x 0.14 mm ² (18 x 0.1 mm) Shielding: copper braid		According to DIN 47100	PVC	Mobile: -5°C ... +80°C Fixed: -40°C ... +80°C	201
PUR Black For M5	3-pos.	M5	3 x 0.14 mm ² (18 x 0.1 mm)		Brown, blue, black	PVC	Mobile: -5°C ... +80°C Fixed: -15°C ... +80°C	170
	4-pos.	M5	4 x 0.14 mm ² (18 x 0.1 mm)		Brown, white, blue, black	PVC	Mobile: -5°C ... +80°C Fixed: -15°C ... +80°C	170

PUR/PVC (for 7/8")



The cables are designed for robust use in machine tools, assembly/production lines, as well as production involving metal cutting.

They are free from silicone and substances that would hinder coating with

paint or varnish and have a high resistance to abrasion. The outer sheath also offers excellent resistance to oil and chemicals according to HD 22.10 and VDE 0282-10 and is flame-retardant according to EN 60332-1-2, UL VW1, and CSA FT1.

Outer sheath material	PUR
Minimum bending radius	7.5 x D
Fixed	15 x D
Mobile	15 x D

Type	Number of positions	Use	Structure	Cross section	Wire colors	Wire insulation	Temperature range	Page
440 Gray	5-pos.	7/8"	5 x 1.5 mm ² (30 x 0.25 mm)		Black 1, black 2, black 3, black 4, green-yellow	PVC	Mobile: -5°C ... +90°C Fixed: -40°C ... +90°C	278
441 Gray	5-pos.	7/8"	5 x 2.5 mm ² (50 x 0.25 mm)		Black 1, black 2, black 3, black 4, green-yellow	PVC	Mobile: -5°C ... +90°C Fixed: -40°C ... +90°C	279

PVC - 80°C and 105°C



These very reasonably priced high-quality cables are suitable for use under dry conditions and average mechanical strain associated with machine tools, packaging machines, and assembly/production lines. The cable offers a certain degree of resistance to oil and chemicals and is less susceptible to wear. Flame-retardant to VW-1 according to UL 758.

VW-1 is the toughest flame-resistance test for single cables.

Outer sheath material PVC
Minimum bending radius 10 x D

Type	Number of positions	Use	Structure	Cross section	Wire colors	Wire insulation	Temperature range	Page
PVC Black	3-pos.	M8	3 x 0.25 mm ² (14 x 0.15 mm)		Brown, blue, black	PVC	Mobile: -5°C ... +80°C Fixed: -25°C ... +80°C	174 236 282
		M12	3 x 0.34 mm ² (19 x 0.15 mm)		Brown, blue, black	PVC	Mobile: -5°C ... +80°C Fixed: -25°C ... +80°C	174 236 282
		M12 Shielded	3 x 0.34 mm ² (42 x 0.1 mm) Shielding: copper braid		Brown, blue, black	PVC	Mobile: -5°C ... +80°C Fixed: -25°C ... +80°C	179 282
		Valve connectors	3 x 0.5 mm ² (16 x 0.2 mm)		Black 1, black 2, green-yellow	PVC	Mobile: -5°C ... +80°C Fixed: -40°C ... +80°C	216 to 224
	4-pos.	M8	4 x 0.25 mm ² (14 x 0.15 mm)		Brown, white, blue, black	PVC	Mobile: -5°C ... +80°C Fixed: -25°C ... +80°C	180 282
		M12	4 x 0.34 mm ² (19 x 0.15 mm)		Brown, white, blue, black	PVC	Mobile: -5°C ... +80°C Fixed: -25°C ... +80°C	180 282
		M12 Shielded	4 x 0.34 mm ² (42 x 0.1 mm) Shielding: copper braid		Brown, white, blue, black	PVC	Mobile: -5°C ... +80°C Fixed: -25°C ... +80°C	185 282
		Valve connectors	4 x 0.5 mm ² (16 x 0.2 mm)		Black 1, black 2, black 3, green-yellow	PVC	Mobile: -5°C ... +80°C Fixed: -40°C ... +80°C	228
	5-pos.	M12	5 x 0.34 mm ² (19 x 0.15 mm)		Brown, white, blue, black, green-yellow	PVC	Mobile: -5°C ... +80°C Fixed: -25°C ... +80°C	187 282

Sensor/actuator cabling



Sensor/actuator cable - cable range

Type	Number of positions	Use	Structure	Cross section	Wire colors	Wire insulation	Temperature range	Page	
PVC Black	5-pos.	M12 Shielded	5 x 0.34 mm ² (42 x 0.1 mm) Shielding: copper braid		Brown, white, blue, black, green-yellow	PVC	Mobile: -5°C ... +80°C Fixed: -25°C ... +80°C	190 282	
		Valve connectors	5 x 0.5 mm ² (28 x 0.15 mm)		Black 1, black 2, black 3, black 4, green-yellow	PVC	Mobile: -5°C ... +80°C Fixed: -40°C ... +80°C	216 to 224	
	8-pos.	M12	8 x 0.25 mm ² (14 x 0.15 mm)		White, brown, green, yellow, gray, pink, blue, red	PVC	Mobile: -5°C ... +80°C Fixed: -25°C ... +80°C	194 282	
		M12 Shielded	8 x 0.25 mm ² (32 x 0.1 mm) Shielding: copper braid and filler litz wire		White, brown, green, yellow, gray, pink, blue, red	PVC	Mobile: -5°C ... +105°C Fixed: -25°C ... +105°C	197 282	
	12-pos.	M12	12 x 0.14 mm ² (18 x 0.1 mm)		According to DIN 47100	PVC	Mobile: -5°C ... +90°C Fixed: -40°C ... +90°C	199 282	
	17-pos.	M12	17 x 0.14 mm ² (18 x 0.1 mm)		According to DIN 47100	PVC	Mobile: -5°C ... +90°C Fixed: -25°C ... +90°C	199 282	
	500 Gray	3-pos.	M8	3 x 0.25 mm ² (14 x 0.15 mm)		Brown, blue, black	PVC	Mobile: -5°C ... +80°C Fixed: -25°C ... +80°C	174 236
			M12	3 x 0.34 mm ² (19 x 0.15 mm)		Brown, blue, black	PVC	Mobile: -5°C ... +80°C Fixed: -25°C ... +80°C	174 236
			M12 Shielded	3 x 0.34 mm ² (42 x 0.1 mm) Shielding: copper braid		Brown, blue, black	PVC	Mobile: -5°C ... +80°C Fixed: -25°C ... +80°C	179
		4-pos.	M8	4 x 0.25 mm ² (14 x 0.15 mm)		Brown, white, blue, black	PVC	Mobile: -5°C ... +80°C Fixed: -25°C ... +80°C	180
M12			4 x 0.34 mm ² (19 x 0.15 mm)		Brown, white, blue, black	PVC	Mobile: -5°C ... +80°C Fixed: -25°C ... +80°C	180	
M12 Shielded			4 x 0.34 mm ² (42 x 0.1 mm) Shielding: copper braid		Brown, white, blue, black	PVC	Mobile: -5°C ... +80°C Fixed: -25°C ... +80°C	185	

Type	Number of positions	Use	Structure	Cross section	Wire colors	Wire insulation	Temperature range	Page
500 Gray	5-pos.	M12	5 x 0.34 mm ² (42 x 0.1 mm)		Brown, white, blue, black, green-yellow	PVC	Mobile: -5°C ... +80°C Fixed: -25°C ... +80°C	187
		M12 Shielded	5 x 0.34 mm ² (42 x 0.1 mm) Shielding: copper braid		Brown, white, blue, black, gray	PVC	Mobile: -5°C ... +80°C Fixed: -25°C ... +80°C	190
	8-pos.	M12	8 x 0.25 mm ² (32 x 0.1 mm)		White, brown, green, yellow, gray, pink, blue, red	PVC	Mobile: -5°C ... +80°C Fixed: -25°C ... +80°C	194
515 Black	5-pos.	M12	5 x 0.34 mm ² (42 x 0.1 mm)		Brown, white, blue, black, gray	PVC	Mobile: -5°C ... +80°C Fixed: -40°C ... +80°C	187
534 Black	3-pos.	Valve connectors	3 x 0.75 mm ² (24 x 0.2 mm)		Black 1, black 2, green-yellow	PVC	Mobile: -5°C ... +80°C Fixed: -40°C ... +80°C	216 to 224 284
	4-pos.	Valve connectors	4 x 0.75 mm ² (24 x 0.2 mm)		Black 1, black 2, black 3, green-yellow	PVC	Mobile: -5°C ... +80°C Fixed: -40°C ... +80°C	228
	5-pos.	Valve connectors	5 x 0.75 mm ² (24 x 0.2 mm)		Black 1, black 2, black 3, black 4, green-yellow	PVC	Mobile: -5°C ... +80°C Fixed: -40°C ... +80°C	228 284
540 Yellow	3-pos.	M12	3 x 0.34 mm ² (42 x 0.1 mm)		Brown, blue, black	PVC	Mobile: -5°C ... +80°C Fixed: -25°C ... +80°C	174 236
	4-pos.	M12	4 x 0.34 mm ² (42 x 0.1 mm)		Brown, white, blue, black	PVC	Mobile: -5°C ... +80°C Fixed: -25°C ... +80°C	180
	5-pos.	M12	5 x 0.34 mm ² (42 x 0.1 mm)		Brown, white, blue, black, gray	PVC	Mobile: -5°C ... +80°C Fixed: -25°C ... +80°C	187

Sensor/actuator cabling

Sensor/actuator cable - cable range

Type	Number of positions	Use	Structure	Cross section	Wire colors	Wire insulation	Temperature range	Page
542 Yellow	3-pos.	M12	3 x 0.34 mm ² (42 x 0.1 mm)		Brown, blue, black	PVC	Mobile: -5°C ... +105°C Fixed: -25°C ... +105°C	174 236
	4-pos.	M12	4 x 0.34 mm ² (42 x 0.1 mm)		Brown, white, blue, black	PVC	Mobile: -5°C ... +105°C Fixed: -25°C ... +105°C	180
	5-pos.	M12	5 x 0.34 mm ² (42 x 0.1 mm)		Brown, white, blue, black, gray	PVC	Mobile: -5°C ... +105°C Fixed: -25°C ... +105°C	187



PVC (for 7/8")



These very reasonably priced high-quality cables are suitable for use under dry conditions and average mechanical strain associated with machine tools, packaging machines, and assembly/production lines.

The cable offers a certain degree of resistance to oil and chemicals and is less susceptible to wear. Flame-retardant according to IEC 60332-1-2 and UL 1581 Cable Flame Test.

Outer sheath material PVC
Minimum bending radius
 Fixed 4 x D
 Mobile 12.5 x D

Type	Number of positions	Use	Structure	Cross section	Wire colors	Wire insulation	Temperature range	Page
430 Gray	5-pos.	7/8"	5 x 1.5 mm ² (30 x 0.25 mm)		Black 1, black 2, black 3, black 4, green-yellow	PVC	Mobile: -5°C ... +90°C Fixed: -40°C ... +90°C	276
431 Gray	5-pos.	7/8"	5 x 2.5 mm ² (50 x 0.25 mm)		Black 1, black 2, black 3, black 4, green-yellow	PVC	Mobile: -5°C ... +90°C Fixed: -40°C ... +90°C	277

PE-X - for outdoor applications



The halogen-free control cable is suitable for outdoor installation in direct sunlight. The insulation and sheath materials offer excellent resistance to weather, UV, and wear. The outstanding resistance to oil, high degree of flexibility, and low smoke gas density also make it suitable for automation technology as well as machine building and systems manufacturing.

Additional features: halogen-free according to

DIN VDE 0472 Part 815, flame-retardant according to DIN EN 60332-1-2 and 50266-2-5, UV resistant according to DIN VDE 0276-605, oil resistant according to DIN EN 60811-2-1 (168 h at 100°C) and 50306.

Outer sheath material	PE copolymer irradiated
Min. bending cycles Shielded	2 million 1 million
Minimum bending radius	10 x D
Traversal path	10 m
Acceleration	10 m/s²
Speed	3 m/s
Tested at	+20°C ... +25°C

Type	Number of positions	Use	Structure	Cross section	Wire colors	Wire insulation	Temperature range	Page
28X Black	4-pos.	M12	4 x 0.5 mm ² (28 x 0.15 mm)		Brown, white, blue, black	PE copolymer	Mobile: -15°C ... +105°C Fixed: -40°C ... +105°C	phoenixcontact.net/products
		M12 Shielded	4 x 0.5 mm ² (28 x 0.15 mm)		Brown, white, blue, black	PE copolymer	Mobile: -15°C ... +105°C Fixed: -40°C ... +105°C	phoenixcontact.net/products
	5-pos.	M12	5 x 0.5 mm ² (28 x 0.15 mm)		Brown, white, blue, black, gray	PE copolymer	Mobile: -15°C ... +105°C Fixed: -40°C ... +105°C	phoenixcontact.net/products
		M12 Shielded	5 x 0.5 mm ² (28 x 0.15 mm) Shielding: Copper braid		Brown, white, blue, black, gray	PE copolymer	Mobile: -15°C ... +105°C Fixed: -40°C ... +105°C	phoenixcontact.net/products
	8-pos.	M12	8 x 0.25 mm ² (32 x 0.1 mm)		According to DIN 47100	PE copolymer	Mobile: -15°C ... +105°C Fixed: -40°C ... +105°C	phoenixcontact.net/products
		M12 Shielded	8 x 0.25 mm ² (32 x 0.1 mm) Shielding: Copper braid		According to DIN 47100	PE copolymer	Mobile: -15°C ... +105°C Fixed: -40°C ... +105°C	phoenixcontact.net/products

Sensor/actuator cabling

Sensor/actuator cable - cable range

PP-EPDM - for the food industry



This cable with PP-EPDM outer sheath is specifically designed for use in the food industry. Dirt can be easily detected on the light colored surface so that food is not contaminated by coming into contact with the cable. Furthermore, the cable is resistant to common cleaning agents and disinfectants.

Outer sheath material **PP-EPDM**

Minimum bending radius **10 x D**

Type	Number of positions	Use	Structure	Cross section	Wire colors	Wire insulation	Temperature range	Page
600 Light gray	3-pos.	M8	3 x 0.25 mm ² (32 x 0.1 mm)		Brown, blue, black	PP	Fixed: -40°C ... +105°C	phoenixcon tact.net/products
	4-pos.	M8	4 x 0.25 mm ² (32 x 0.1 mm)		Brown, white, blue, black	PP	Fixed: -40°C ... +105°C	phoenixcon tact.net/products
		M12	4 x 0.34 mm ² (42 x 0.1 mm)		Brown, white, blue, black	PP	Fixed: -40°C ... +105°C	phoenixcon tact.net/products
		M12 Shielded	4 x 0.34 mm ² (42 x 0.1 mm) Shielding: Copper braid		Brown, white, blue, black	PP	Fixed: -40°C ... +105°C	phoenixcon tact.net/products
	5-pos.	M12	5 x 0.34 mm ² (42 x 0.1 mm)		Brown, white, blue, black, gray	PP	Fixed: -40°C ... +105°C	phoenixcon tact.net/products



RADOX® - for railway applications



In railway applications, special demands are placed on the cables used. Special considerations must be made regarding fire protection, in that cables must meet the highest fire safety standards. In addition, the cables are very resistant to mineral oil and fuel.

Outer sheath material RADOX® GKW S

Minimum bending radius
Fixed 3 x D
Mobile 4 x D

Type	Number of positions	Use	Structure	Cross section	Wire colors	Wire insulation	Temperature range	Page
28R Black	3-pos.	M12	3 x 0.5 mm ² (19 x 0.18 mm) Shielding: Copper braid		White 1, white 2, white 3	RADOX® TI303	Mobile: -25°C ... +90°C Fixed: -40°C ... +120°C	phoenixcon tact.net/products
	4-pos.	M12	4 x 0.5 mm ² (19 x 0.18 mm) Shielding: Copper braid		White 1, white 2, white 3, white 4	RADOX® TI303	Mobile: -25°C ... +90°C Fixed: -40°C ... +120°C	phoenixcon tact.net/products
	5-pos.	M12	5 x 0.5 mm ² (19 x 0.18 mm) Shielding: Copper braid		White 1, white 2, white 3, white 4, white 5	RADOX® TI303	Mobile: -25°C ... +90°C Fixed: -40°C ... +120°C	phoenixcon tact.net/products

Sensor/actuator cabling

Sensor/actuator boxes - cable range

PUR/PVC (for sensor/actuator boxes)









The cables are designed for robust use in machine tools, assembly/production lines, as well as production involving metal cutting. They are free from silicone and substances that would hinder coating with paint or varnish and have a high resistance to abrasion. The outer sheath also offers excellent resistance to oil and chemicals according to VDE 0472 Part 803, is flame-retardant according to DIN EN 50265, and is resistant to hydrolysis. The outer sheath

is manufactured using the coextrusion process.

Outer sheath material PUR
Inner sheath material PVC

Min. bending cycles 1.5 ... 2 million
Minimum bending radius 10 x D
Traverse path 2 m
Speed 2 m/s
Tested at +20°C ... +25°C

Type	Number of positions	Use	Structure	Cross section	Wire colors	Wire insulation	Temperature range	Page
PUR/PVC Black	3-pos., single-occu- pancy	M8 and QUICKON up to 0.34 mm ² 4 slots	4 x 0.34 mm ² 2 x 0.75 mm ²		White, green, yellow, gray, brown, blue	PVC	Mobile: -5°C ... +80°C Fixed: -40°C ... +90°C	246 252 285
		M8 and QUICKON up to 0.34 mm ² 6 slots	6 x 0.34 mm ² 2 x 0.75 mm ²		White, green, yellow, gray, pink, red, brown, blue	PVC	Mobile: -5°C ... +80°C Fixed: -40°C ... +90°C	246 252 285
		M8 and QUICKON up to 0.34 mm ² 8 slots	8 x 0.34 mm ² 2 x 0.75 mm ²		White, green, yellow, gray, pink, red, black, violet, brown, blue	PVC	Mobile: -5°C ... +80°C Fixed: -40°C ... +90°C	246 252 285
		M8 10 slots	10 x 0.34 mm ² 2 x 0.75 mm ²		White, green, yellow, gray, pink, red, black, violet, white-pink, pink-brown, brown, blue	PVC	Mobile: -5°C ... +80°C Fixed: -40°C ... +90°C	246 285
	4-pos., double-occu- pancy	QUICKON up to 0.34 mm ² 4 slots	8 x 0.34 mm ² 2 x 0.75 mm ²		White, green, yellow, gray, gray-pink, red-blue, white-green, brown-green, brown, blue	PVC	Mobile: -5°C ... +80°C Fixed: -40°C ... +90°C	252
		M8 and QUICKON up to 0.34 mm ² 8 slots	16 x 0.34 mm ² 2 x 0.75 mm ²		White, green, yellow, gray, pink, red, black, violet, gray-pink, red-blue, white-green, brown-green, white-yellow, yellow- brown, white-gray, gray-brown, brown, blue	PVC	Mobile: -5°C ... +80°C Fixed: -40°C ... +90°C	246 252 285

Type	Number of positions	Use	Structure	Cross section	Wire colors	Wire insulation	Temperature range	Page
PUR/PVC Black	4-pos., single- occupancy	M12 and QUICKON up to 0.75 mm ² 4 slots	4 x 0.34 mm ² 3 x 0.75 mm ²		White, green, yellow, gray, brown, blue, green-yellow	PVC	Mobile: -5°C ... +80°C Fixed: -40°C ... +90°C	248 250 253 285
		M12 and QUICKON up to 0.75 mm ² 6 slots	6 x 0.34 mm ² 3 x 0.75 mm ²		White, green, yellow, gray, pink, red, brown, blue, green-yellow	PVC	Mobile: -5°C ... +80°C Fixed: -40°C ... +90°C	248 250 253 285
		M12 and QUICKON up to 0.75 mm ² 8 slots	8 x 0.34 mm ² 3 x 0.75 mm ²		White, green, yellow, gray, pink, red, black, violet, brown, blue, green-yellow	PVC	Mobile: -5°C ... +80°C Fixed: -40°C ... +90°C	248 250 253 285
	5-pos., double-occu- pancy	M12 4 slots	8 x 0.50 mm ² 3 x 1.00 mm ²		White, green, yellow, gray, gray-pink, red-blue, white-green, brown-green, brown, blue, green-yellow	PVC	Mobile: -5°C ... +80°C Fixed: -40°C ... +90°C	248 250 285
		M12 6 slots	12 x 0.50 mm ² 3 x 1.00 mm ²		White, green, yellow, gray, pink, red, gray-pink, red-blue, white-green, brown-green, white-yellow, yellow-brown, brown, blue, green-yellow	PVC	Mobile: -5°C ... +80°C Fixed: -40°C ... +90°C	248 250 285
		M12 8 slots	16 x 0.50 mm ² 3 x 1.00 mm ²		White, green, yellow, gray, pink, red, black, violet, gray-pink, red-blue, white-green, brown-green, white-yellow, yellow-brown, white-gray, gray-brown, brown, blue, green-yellow	PVC	Mobile: -5°C ... +80°C Fixed: -40°C ... +90°C	248 250 285

Sensor/actuator cabling

Sensor/actuator boxes - cable range

PUR/PVC shielded (for sensor/actuator boxes)



The cables are designed for robust use in machine tools, assembly/production lines, as well as production involving metal cutting. Analog signals are reliably protected against electromagnetic influences by the tin-plated copper braid with 85% coverage. The cables are free from silicone and substances that would hinder coating with paint or varnish and have a high resistance

to abrasion. The outer sheath also offers excellent resistance to oil and chemicals according to VDE 0472 Part 803, is flame-retardant according to DIN EN 50265, and is resistant to hydrolysis.

Outer sheath material	PUR
Inner sheath material	PVC
Min. bending cycles	1.5 ... 2 million
Minimum bending radius	10 x D
Traverse path	2 m
Speed	2 m/s
Tested at	+20°C ... +25°C

Type	Number of positions	Use	Structure	Cross section	Wire colors	Wire insulation	Temperature range	Page
PUR/PVC shielded Black	5-pos., double-occu- pancy	M12 4 slots	8 x 0.50 mm ² 3 x 1.00 mm ²		White, green, yellow, gray, gray-pink, red-blue, white-green, brown-green, brown, blue, green-yellow	PVC	Mobile: -5°C ... +80°C Fixed: -40°C ... +90°C	254 285
		M12 6 slots	12 x 0.50 mm ² 3 x 1.00 mm ²		White, green, yellow, gray, pink, red, gray-pink, red-blue, white-green, brown-green, white-yellow, yellow-brown, brown, blue, green-yellow	PVC	Mobile: -5°C ... +80°C Fixed: -40°C ... +90°C	254 285
		M12 8 slots	16 x 0.50 mm ² 3 x 1.00 mm ²		White, green, yellow, gray, pink, red, black, violet, gray-pink, red-blue, white-green, brown-green, white-yellow, yellow-brown, white-gray, gray-brown, brown, blue, green-yellow	PVC	Mobile: -5°C ... +80°C Fixed: -40°C ... +90°C	254 285

PVC - for the food industry (for sensor/actuator boxes)



Master cable that is resistant to cleaning agents for use in the splash zone. Can be used together with our stainless steel sensor/actuator box to implement signal distribution in a washdown design. The cable is flame-retardant according to IEC 60332-1-2 and UL 758 FT2 and has an oil-resistant outer sheath according to DIN EN 60811-404.

Outer sheath material	PVC
Minimum bending radius	
Fixed	5 x D
Mobile	10 x D

Type	Number of positions	Use	Structure	Cross section	Wire colors	Wire insulation	Temperature range	Page
PVC Black	5-pos., double-occu- pancy	M12 8 slots	16 x 0.50 mm ² 3 x 1.00 mm ²		White, green, yellow, gray, pink, red, black, violet, gray-pink, red-blue, white-green, brown-green, white-yellow, yellow-brown, white-gray, gray-brown, brown, blue, green-yellow	PVC	Mobile: -5°C ... +90°C Fixed: -40°C ... +90°C	See: phoenixcon- tact.net/prod- ucts

PUR, halogen-free (for sensor/actuator boxes)



Permanently flexible control cables for use in drag chains and as machine control cables for extreme operating conditions. Suitable for bending cycle loads with long-term durability. The special PUR outer sheath offers excellent resistance to oils according to VDE 0472 Part 803, lubricants, cooling agents, and other aggressive substances. Additional features: halogen-

and PVC-free, no silicone or substances that would hinder coating with paint or varnish, resistant to hydrolysis, and flame-retardant according to DIN EN 50265.

Outer sheath material	PUR
Min. bending cycles	1.5 ... 2 million
Minimum bending radius	10 x D
Traverse path	2 m
Speed	2 m/s
Tested at	+20°C ... +25°C

Type	Number of positions	Use	Structure	Cross section	Wire colors	Wire insulation	Temperature range	Page
PUR Black	5-pos., double-occu- pancy	M12 4 slots	8 x 0.50 mm ² 3 x 1.00 mm ²		White, green, yellow, gray, gray-pink, red-blue, white-green, brown-green, brown, blue, green-yellow	PP	Mobile: -5°C ... +80°C Fixed: -40°C ... +90°C	250 285
		M12 6 slots	12 x 0.50 mm ² 3 x 1.00 mm ²		White, green, yellow, gray, pink, red, gray-pink, red-blue, white-green, brown-green, white-yellow, yellow-brown, brown, blue, green-yellow	PP	Mobile: -5°C ... +80°C Fixed: -40°C ... +90°C	250 285
		M12 8 slots	16 x 0.50 mm ² 3 x 1.00 mm ²		White, green, yellow, gray, pink, red, black, violet, gray-pink, red-blue, white-green, brown-green, white-yellow, yellow-brown, white-gray, gray-brown, brown, blue, green-yellow	PP	Mobile: -5°C ... +80°C Fixed: -40°C ... +90°C	250 285

80 MC - highly stranded (for sensor/actuator boxes)

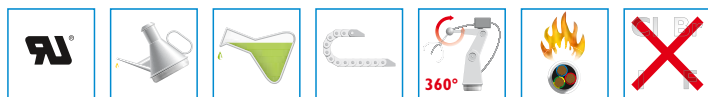

Permanently flexible cables for use in drag chains, industrial robots or portal tables. Suitable for bending cycle loads and torsional stress with long-term durability. The special PUR outer sheath offers excellent resistance to oils according to DIN EN 60811-2-1, chemicals, and hydrolysis.

The cable is also flame-retardant according to DIN EN 50265-2-1 and is halogen-free.

Outer sheath material	PUR
Min. bending cycles	5 million
Minimum bending radius	10 x D
Traverse path	5 m
Acceleration	5 m/s²
Speed	3 m/s
Torsion angle	+/- 120°
Min. torsion cycles	3 million
Test length	1 m
Tested at	+20°C ... +25°C

Type	Number of positions	Use	Structure	Cross section	Wire colors	Wire insulation	Temperature range	Page
80MC Black	5-pos., double-occu- pancy	M12 8 slots	16 x 0.50 mm ² 3 x 1.00 mm ²		White, green, yellow, gray, pink, red, black, violet, gray-pink, red-blue, white-green, brown-green, white-yellow, yellow-brown, white-gray, gray-brown, brown, blue, green-yellow	PP	Mobile: +5°C ... +70°C Fixed: -30°C ... +70°C	285



The following pages provide an overview of the appropriate installation of SAC cables in harsh industrial environments that will guarantee a long service life and reduce costs.

Bending radius

In the case of a mobile installation, a generous bending radius can be advantageous, since the greater the bending radius, the lower the voltages occurring as a result of the movement. The result is an increased cable service life (the minimum cable-specific bending radii must be taken into consideration).

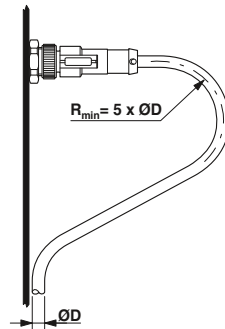

Fixed installation

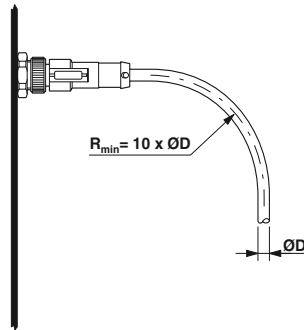

Mobile installation

Load

A sufficient cable loop at the connection point can prevent the material from becoming prematurely worn and in the case of additional loads ensures sufficient clearance for voltages to be absorbed.

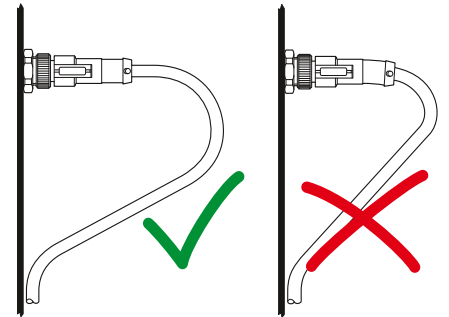

Mobile installation

In the case of a mobile installation, the cable length should be sufficient to adequately absorb the tensile loads. This can be implemented, for example, using cable loops and C drag chains.



Cables in power track chains

Where possible, cables should be laid individually and loosely next to each other within power track chains. Isolating segments or bridges should be placed between the various cables or these should be arranged into separate bore holes in the neutral zone of the drag chain.

The laying of cables that have very different outside diameters next to or across each other is generally not recommended. If, however, this cannot be avoided for design reasons, isolating segments or bridges should be installed for a reasonable service life. If isolating segments cannot be installed between each cable, we recommend that our cables with an outside diameter < 10 mm should be laid loose, together with cables with similar cross sections within a guide tube in the drag chain.

In terms of the arrangement of the cables, it is also important to ensure that heavy cables are routed outwards and light cables, such as our SAC cables, are routed inwards. They should be strain-relieved on both sides, or at least at the moving end of the drag chain. A distance of 20 to 30 times the outside diameter of the cable is recommended between the point at which the bending motion ends and the attachment.

The cables must be able to move completely freely within the radius of curvature in order to prevent forced guidance of the drag chain. Guide value: 10% of the outside diameter should be allocated as free space.

Note: when laying the cables, observe the information provided by the drag chain manufacturer.

Cable bundling

When bundling several individual cables, it is important to ensure that the cables can move freely within the bundle. The cables must not become deformed. Round cables with greatly varying outside diameters should only be laid next to each other when bridges are used.

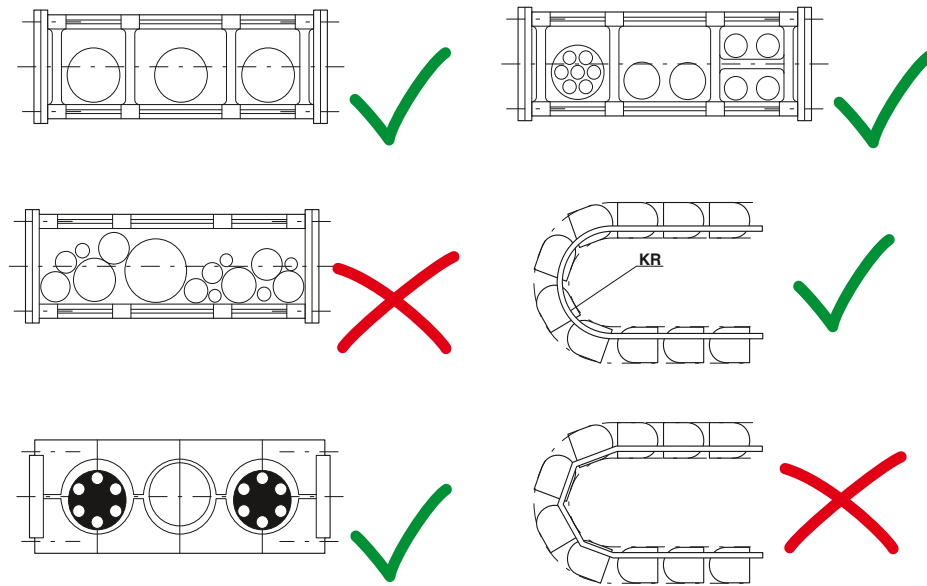
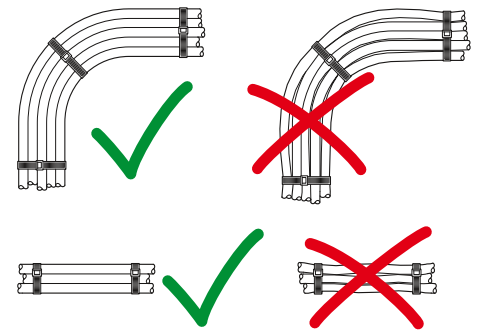

KR = radius of curvature

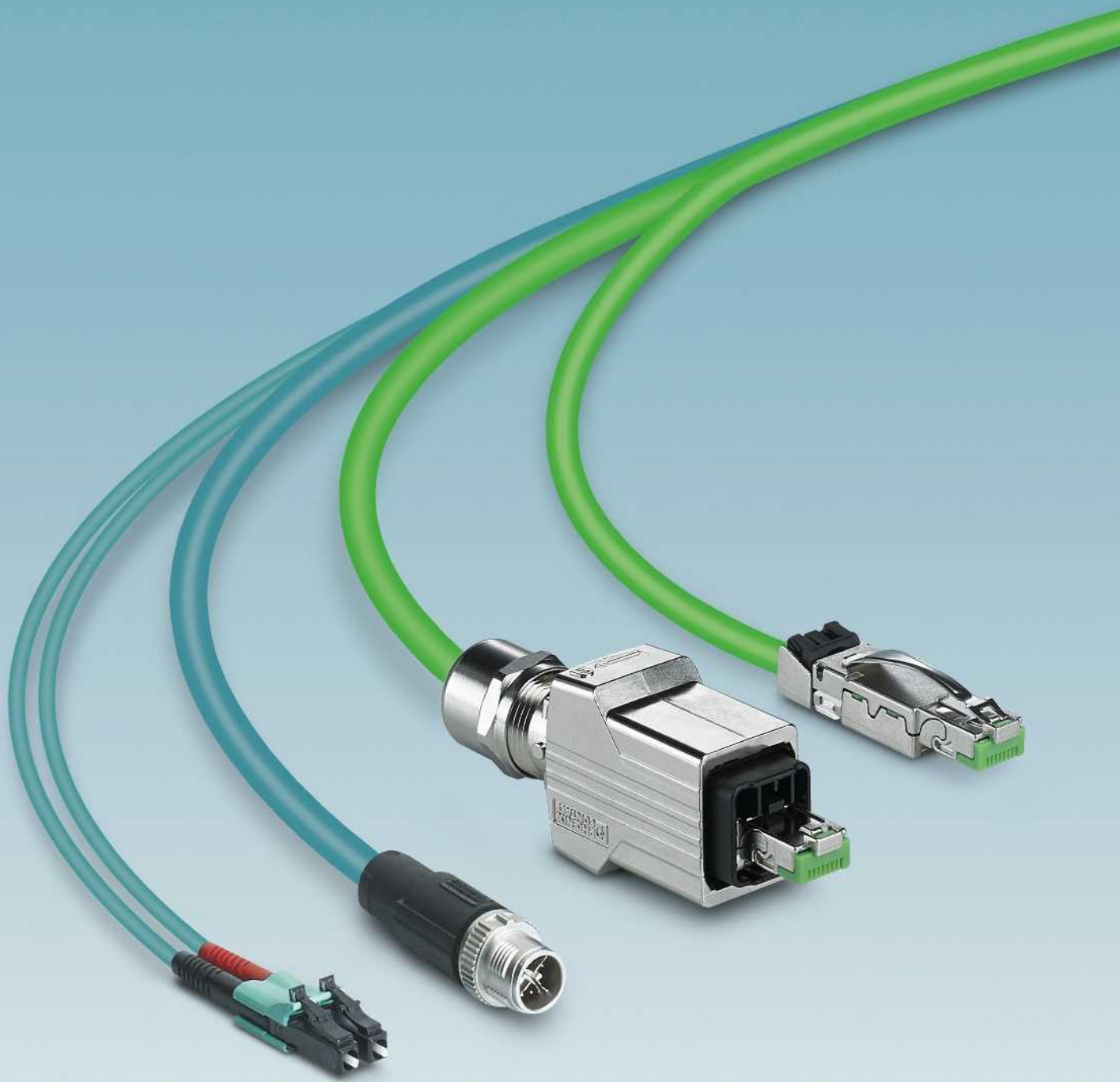

Data connectors and cables

Standardized data interfaces are increasingly being used in industrial applications as part of the decentralization of complex manufacturing systems and the increasing need for rapid information and data exchange.

PLUSCON data is the connector range from Phoenix Contact for secure and reliable data transmission. Benefit from innovative connection technologies and a design suitable for industrial applications. The product range includes assembled cables, flush-type connectors, and connectors for field assembly, plus special tool-free connector systems for FO and copper-based cabling.

When it comes to implementing networks, Phoenix Contact offers a comprehensive portfolio for Industrial Ethernet and PROFINET as well as EtherCAT®. Furthermore, we offer components for fieldbus systems such as PROFIBUS, CANopen®/DeviceNet™, and FOUNDATION Fieldbus.

Solutions for copper cabling

- Up to 10 Gbps
- Protection class IP20 to IP69K
- 4 and 8-pos. versions
- Spring, pierce, and IDC displacement connection
- 360° shielding concept
- For all common networks and fieldbuses

Solutions for FO cabling

- Up to 40 Gbps
- Protection class IP20 to IP65/67
- For POF, PCF, and GOF
- For all common FO interfaces

System overview - network	320
System overview - fieldbuses	322
Network components	
M12 connectors	324
Version 1 connectors	330
Version 4 connectors	334
Version 6 connectors	336
Version 14 connectors	344
IP20 connectors	360
Accessories	370
Patch cables	374
Assembled cables	380
Assembled FO cables	396
Fieldbus components	
M12 connectors	406
M12 flush-type connectors	408
Assembled cables	412
AS-Interface	426
D-SUB connectors	432
D-SUB-based connectors	436
USB connectors	438
Cable range	440

Industrial Ethernet



Ethernet

Ethernet

Ethernet

Ethernet

Ethernet

Area of application	Ethernet M8 (4-pos.) All industrial environments	Ethernet M12 (4-pos.) All industrial environments	Ethernet M12 (8-pos.) All industrial environments	Ethernet M12/10G (8-pos.) All industrial environments	Ethernet hybrid M12 (8-pos.) All industrial environments
Topology	Star, tree or line topology	Star, tree or line topology	Star, tree or line topology	Star, tree or line topology	Star, tree or line topology
Data transmission	Up to 100 Mbps	Up to 100 Mbps	Up to 1 Gbps	Up to 10 Gbps	Up to 100 Mbps

Special connectors

M12 with shield crossover

M12 with Y-shield

Pin assignment	Signal des.		Connector		Signal des.	Connector		Signal des.	Connector		Signal des.	Connector	
			RJ45	M8		RJ45	M12		RJ45	M12		RJ45	M12
TD+			1	1	TD+	1	1	D1+	1	1	TD+		1
TD-			2	4	TD-	2	3	D1-	2	2	TD-		2
RD+			3	2	RD+	3	2	D3+	5	7	RD+		3
RD-			6	3	RD-	6	4	D3-	4	8	RD-		4
								D2+	3	3			
								D2-	6	4			
								D4+	7	5			
								D4-	8	6			

Signal designation Wire assignment

Wire color	Signal	Wire color	Signal	Wire color	Signal	Wire color	Signal	Wire color	Signal
YE	TD+	WHOG	TD+	WHOG	D1+	WHOG	D1+	WHOG	TD+
OG	TD-	OG	TD-	OG	D1-	OG	D1-	OG	TD-
WH	RD+	WHGN	RD+	WHBU	D3+	WHBU	D3+	WHGN	RD+
BU	RD-	GN	RD-	BU	D3-	BU	D3-	GN	RD-
				WHGN	D2+	WHGN	D2+	BU	
				GN	D2-	GN	D2-	WH	
				WHBN	D4+	WHBN	D4+	BN	
				BN	D4-	BN	D4-	BK	

Segment length	Up to 100 m from hub/switch to termination device	Up to 100 m from hub/switch to termination device	Up to 100 m from hub/switch to termination device	Up to 100 m from hub/switch to termination device	Up to 100 m from hub/switch to termination device
-----------------------	---	---	---	---	---

User organization

Standardization of cabling	ISO/IEC 24702	ISO/IEC 24702	ISO/IEC 24702	ISO/IEC 24702	
Connector pin assignments					
	Plug Socket	Plug Socket	Plug Socket	Plug Socket	Plug Socket
	M8, 4-pos.	M12, 4-pos., D-coded	M12, 8-pos., A-coded	M12, 8-pos., X-coded	M12, hybrid, 8-pos., Y-coded
	Plug Socket	Plug Socket	Plug Socket	Plug Socket	
	RJ45, 8-pos.	RJ45, 8-pos.	RJ45, 8-pos.	RJ45, 8-pos.	

Topology	See phoenixcontact.net/products	See phoenixcontact.net/products	See phoenixcontact.net/products	See phoenixcontact.net/products	See phoenixcontact.net/products
-----------------	--	--	--	--	--

Ethernet/IP™	PROFINET	EtherCAT®	Sercos®	VARAN	
Automation applications in industrial control technology	Automation applications in industrial control technology	Production, process automation in the automotive industry	Automation technology	Motion control applications	Automation technology
Usually active star topology	Usually active star topology	Star, line, tree, and ring structures. Hybrid forms also supported.	Line, tree, star, and combinations of these	Line, ring, and hierarchical, cascaded network structures	Tree, line, and star topology
Up to 100 Mbps	Up to 100 Mbps	100 Mbps to 1 Gbps	100 Mbps, upgrade to Gigabit Ethernet possible	Fast Ethernet with 100 Mbps	Up to Gigabit Ethernet

2+4 power/Ethernet connection technology (IP65 and IP67)

Signal des.	Connector		Signal des.	Connector		Signal des.	Connector		Signal des.	Connector		Signal des.	Connector		Signal des.	Connector	
	RJ45	M12		RJ45	M12		RJ45	M12		RJ45	M12		RJ45	M12		RJ45	M12
TD+	1	1	D1+	1	1	TD+	1	1	TD+	1	1	TD+	2	2	TD+	2	
TD-	2	3	D1-	2	2	TD-	2	3	TD-	2	3	TD-	1	3	TD-	1	
RD+	3	2	D3+	5	7	RD+	3	2	RD+	3	2	RD+	3	5	RD+	3	
RD-	6	4	D3-	4	8	RD-	6	4	RD-	6	4	RD-	6	8	RD-	6	
			D2+	3	3												
			D2-	6	4												
			D4+	7	5												
			D4-	8	6												

Wire color	Signal	Wire color	Signal	Wire color	Signal	Wire color	Signal	Wire color	Signal	Wire color	Signal
WHOG	TD+	WHOG	D1+	YE	TD+	YE	TD+	YE	TD+	n. c.	
OG	TD-	OG	D1-	OG	TD-	OG	TD-	OG	TD-	OG	TD-
WHBU		WHBU	D3+	WH	RD+	WH	RD+	WH	RD+	WHOG	TD+
BU		BU	D3-	BU	RD-	BU	RD-	BU	RD-	n. c.	
WHGN	RD+	WHGN	D2+							WHGN	RD+
GN	RD-	GN	D2-							BU	
WHBN		WHBN	D4+							BN	
BN		BN	D4-							GN	RD-

Up to 100 m from hub/switch to termination device	Up to 100 m from hub/switch to termination device	Up to 100 m from hub/switch to termination device	Up to 100 m from hub/switch to termination device	Up to 100 m from hub/switch to termination device	Up to 100 m from hub/switch to termination device
---	---	---	---	---	---

www.odva.org	www.odva.org	www.profibus.com	www.ethercat.org	www.sercos.de	www.varan-bus.net
--	--	--	--	--	--

IEC 61784-5-2	IEC 61784-5-2	IEC 61784-5-3	IEC 61784-5-12	IEC 61784-5-16	
---------------	---------------	---------------	----------------	----------------	--

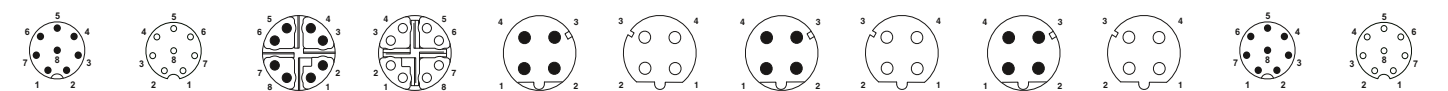

Plug	Socket	Plug	Socket	Plug	Socket	Plug	Socket	Plug	Socket	Plug	Socket
M12, 8-pos., A-coded		M12, 8-pos., X-coded		M12, 4-pos., D-coded		M12, 4-pos., D-coded		M12, 4-pos., D-coded		M12, 8-pos., A-coded	

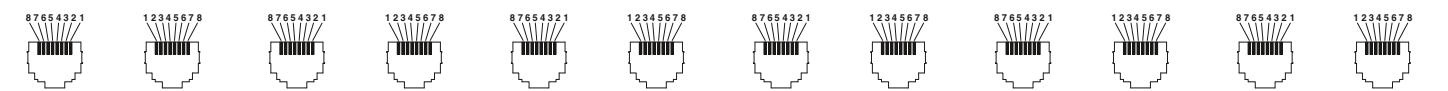





















































Plug	Socket	Plug	Socket	Plug	Socket	Plug	Socket	Plug	Socket	Plug	Socket
RJ45, 8-pos.		RJ45, 8-pos.		RJ45, 8-pos.		RJ45, 8-pos.		RJ45, 8-pos.		RJ45, 8-pos.	

See phoenixcontact.net/products	See phoenixcontact.net/products	See phoenixcontact.net/products	See phoenixcontact.net/products	See phoenixcontact.net/products	See phoenixcontact.net/products
--	--	--	--	--	--

Data connectors and cables

System overview - fieldbuses

	INTERBUS	PROFIBUS DP	PROFIBUS PA	DeviceNet™																																																																																			
																																																																																							
Area of application	Sensor/actuator level, process automation, monitoring PC	Distributed I/O devices for networking several controllers	Process automation for potentially explosive areas (Ex zone 0 and 1)	Automation technology																																																																																			
Topology	Active ring structure	Line, tree, ring or star depending on the physical network design	Line, tree or ring	Line																																																																																			
Data transmission	Between 500 kbps and 16 Mbps depending on the segment length	Up to 12 Mbps	Up to 31.25 kbps	Up to 500 kBaud																																																																																			
Special connectors																																																																																							
Pin assignment	<table border="1"> <thead> <tr> <th>Signal designation</th> <th colspan="2">Connector</th> </tr> <tr> <th></th> <th>D-SUB 9</th> <th>M12</th> </tr> </thead> <tbody> <tr> <td>DO</td> <td>1</td> <td>2</td> </tr> <tr> <td>DO</td> <td>6</td> <td>1</td> </tr> <tr> <td>DI</td> <td>2</td> <td>4</td> </tr> <tr> <td>DI</td> <td>7</td> <td>3</td> </tr> <tr> <td>GND</td> <td>3</td> <td>5</td> </tr> </tbody> </table>	Signal designation	Connector			D-SUB 9	M12	DO	1	2	DO	6	1	DI	2	4	DI	7	3	GND	3	5	<table border="1"> <thead> <tr> <th>Signal designation</th> <th colspan="2">Connector</th> </tr> <tr> <th></th> <th>D-SUB 9</th> <th>M12</th> </tr> </thead> <tbody> <tr> <td>A cable</td> <td>8</td> <td>2</td> </tr> <tr> <td>B cable</td> <td>3</td> <td>4</td> </tr> </tbody> </table>	Signal designation	Connector			D-SUB 9	M12	A cable	8	2	B cable	3	4	<table border="1"> <thead> <tr> <th>Signal designation</th> <th colspan="2">Connector</th> </tr> <tr> <th></th> <th>M12</th> <th></th> </tr> </thead> <tbody> <tr> <td>DATA+</td> <td>1</td> <td></td> </tr> <tr> <td>DATA-</td> <td>3</td> <td></td> </tr> <tr> <td>Shield</td> <td>4</td> <td></td> </tr> </tbody> </table>	Signal designation	Connector			M12		DATA+	1		DATA-	3		Shield	4		<table border="1"> <thead> <tr> <th>Signal designation</th> <th colspan="4">Connector</th> </tr> <tr> <th></th> <th>COMBICON</th> <th>M12</th> <th>7/8"</th> <th>M8</th> </tr> </thead> <tbody> <tr> <td>CAN_L</td> <td>2</td> <td>5</td> <td>5</td> <td>5</td> </tr> <tr> <td>CAN_H</td> <td>4</td> <td>4</td> <td>4</td> <td>3</td> </tr> <tr> <td>V+</td> <td>5</td> <td>2</td> <td>2</td> <td>2</td> </tr> <tr> <td>V-</td> <td>1</td> <td>3</td> <td>3</td> <td>4</td> </tr> <tr> <td>Drain</td> <td>3</td> <td>1</td> <td>1</td> <td>1</td> </tr> </tbody> </table>	Signal designation	Connector					COMBICON	M12	7/8"	M8	CAN_L	2	5	5	5	CAN_H	4	4	4	3	V+	5	2	2	2	V-	1	3	3	4	Drain	3	1	1	1
Signal designation	Connector																																																																																						
	D-SUB 9	M12																																																																																					
DO	1	2																																																																																					
DO	6	1																																																																																					
DI	2	4																																																																																					
DI	7	3																																																																																					
GND	3	5																																																																																					
Signal designation	Connector																																																																																						
	D-SUB 9	M12																																																																																					
A cable	8	2																																																																																					
B cable	3	4																																																																																					
Signal designation	Connector																																																																																						
	M12																																																																																						
DATA+	1																																																																																						
DATA-	3																																																																																						
Shield	4																																																																																						
Signal designation	Connector																																																																																						
	COMBICON	M12	7/8"	M8																																																																																			
CAN_L	2	5	5	5																																																																																			
CAN_H	4	4	4	3																																																																																			
V+	5	2	2	2																																																																																			
V-	1	3	3	4																																																																																			
Drain	3	1	1	1																																																																																			
Signal designation, wire assignment	<table border="1"> <thead> <tr> <th>Wire color</th> <th>Signal</th> </tr> </thead> <tbody> <tr> <td>YE</td> <td>DO</td> </tr> <tr> <td>GN</td> <td>DQ</td> </tr> <tr> <td>GY</td> <td>DI</td> </tr> <tr> <td>PK</td> <td>DI</td> </tr> <tr> <td>BN</td> <td>GND</td> </tr> <tr> <td>WH</td> <td>NC</td> </tr> </tbody> </table>	Wire color	Signal	YE	DO	GN	DQ	GY	DI	PK	DI	BN	GND	WH	NC	<table border="1"> <thead> <tr> <th>Wire color</th> <th>Signal</th> </tr> </thead> <tbody> <tr> <td>GN</td> <td>A cable</td> </tr> <tr> <td>RD</td> <td>B cable</td> </tr> </tbody> </table>	Wire color	Signal	GN	A cable	RD	B cable	<table border="1"> <thead> <tr> <th>Wire color</th> <th>Signal</th> </tr> </thead> <tbody> <tr> <td>OG</td> <td>DATA+</td> </tr> <tr> <td>BU</td> <td>DATA-</td> </tr> <tr> <td></td> <td>Filler litz wire</td> </tr> </tbody> </table>	Wire color	Signal	OG	DATA+	BU	DATA-		Filler litz wire	<table border="1"> <thead> <tr> <th>Wire color</th> <th>Signal</th> </tr> </thead> <tbody> <tr> <td>BU</td> <td>CAN_L</td> </tr> <tr> <td>WH</td> <td>CAN_H</td> </tr> <tr> <td>RD</td> <td>V+</td> </tr> <tr> <td>BK</td> <td>V-</td> </tr> </tbody> </table>	Wire color	Signal	BU	CAN_L	WH	CAN_H	RD	V+	BK	V-																																													
Wire color	Signal																																																																																						
YE	DO																																																																																						
GN	DQ																																																																																						
GY	DI																																																																																						
PK	DI																																																																																						
BN	GND																																																																																						
WH	NC																																																																																						
Wire color	Signal																																																																																						
GN	A cable																																																																																						
RD	B cable																																																																																						
Wire color	Signal																																																																																						
OG	DATA+																																																																																						
BU	DATA-																																																																																						
	Filler litz wire																																																																																						
Wire color	Signal																																																																																						
BU	CAN_L																																																																																						
WH	CAN_H																																																																																						
RD	V+																																																																																						
BK	V-																																																																																						
	Shield on housing	Shield on housing	Shield on pin	Shield on pin																																																																																			
Segment length	400 m segment length between two devices; max. 13 km total length	Up to 1200 m with copper installation, up to 15 km with fiber optic installation	Max. 1900 m	Up to 500 m																																																																																			
User organization	www.interbusclub.com	www.profibus.com	www.profibus.com	www.odva.org																																																																																			
Standardization of cabling	IEC 61158	IEC 61158/IEC 61784	IEC 61158/IEC 61784	IEC 61158 IEC 61784-1 CPF 2/3																																																																																			
Connector pin assignments	<table border="1"> <tr> <td></td> <td></td> </tr> <tr> <td>Plug</td> <td>Socket</td> </tr> <tr> <td colspan="2">M12, 5-pos., B-coded</td> </tr> <tr> <td></td> <td></td> </tr> <tr> <td>Plug</td> <td>Socket</td> </tr> <tr> <td colspan="2">D-SUB 9</td> </tr> </table>			Plug	Socket	M12, 5-pos., B-coded				Plug	Socket	D-SUB 9		<table border="1"> <tr> <td></td> <td></td> </tr> <tr> <td>Plug</td> <td>Socket</td> </tr> <tr> <td colspan="2">M12, 5-pos., B-coded</td> </tr> <tr> <td></td> <td></td> </tr> <tr> <td>Plug</td> <td>Socket</td> </tr> <tr> <td colspan="2">D-SUB 9</td> </tr> </table>			Plug	Socket	M12, 5-pos., B-coded				Plug	Socket	D-SUB 9		<table border="1"> <tr> <td></td> <td></td> </tr> <tr> <td>Plug</td> <td>Socket</td> </tr> <tr> <td colspan="2">M12, 3-pos., A-coded</td> </tr> </table>			Plug	Socket	M12, 3-pos., A-coded		<table border="1"> <tr> <td></td> <td></td> </tr> <tr> <td>Plug</td> <td>Socket</td> </tr> <tr> <td colspan="2">M8, 5-pos., B-coded</td> </tr> <tr> <td></td> <td></td> </tr> <tr> <td>Plug</td> <td>Socket</td> </tr> <tr> <td colspan="2">M12, 5-pos., A-coded</td> </tr> <tr> <td></td> <td></td> </tr> <tr> <td>Plug</td> <td>Socket</td> </tr> <tr> <td colspan="2">7/8" 16UNF, 5-pos.</td> </tr> </table>			Plug	Socket	M8, 5-pos., B-coded				Plug	Socket	M12, 5-pos., A-coded				Plug	Socket	7/8" 16UNF, 5-pos.																																				
																																																																																							
Plug	Socket																																																																																						
M12, 5-pos., B-coded																																																																																							
																																																																																							
Plug	Socket																																																																																						
D-SUB 9																																																																																							
																																																																																							
Plug	Socket																																																																																						
M12, 5-pos., B-coded																																																																																							
																																																																																							
Plug	Socket																																																																																						
D-SUB 9																																																																																							
																																																																																							
Plug	Socket																																																																																						
M12, 3-pos., A-coded																																																																																							
																																																																																							
Plug	Socket																																																																																						
M8, 5-pos., B-coded																																																																																							
																																																																																							
Plug	Socket																																																																																						
M12, 5-pos., A-coded																																																																																							
																																																																																							
Plug	Socket																																																																																						
7/8" 16UNF, 5-pos.																																																																																							
Topology	See phoenixcontact.net/products	See phoenixcontact.net/products	See phoenixcontact.net/products	See phoenixcontact.net/products																																																																																			

CANopen®	AS-Interface	FOUNDATION Fieldbus	USB	CC-Link																																																																																											
Automation technology and for networking within complex devices	Sensor/actuator level	Process automation	All industrial environments	Production level applications																																																																																											
Line or tree (when using repeaters)	Bus, star, ring, and tree structures	Point-to-point line (with branch lines), tree structure, combination of all topologies	Star topology, the connection is established at the star nodes via hubs	Bus, multi-drop, T-branching, star																																																																																											
10 kBaud to 1 Mbaud	167 kbps	H1: 31.25 kbps, IEC physical transmission channel, incl. Ex bus H2: 1.0 and 2.5 Mbps data rate, via two-wire cable or fiber optics	Up to 480 Mbps	Up to 10 Mbps																																																																																											
<table border="1"> <thead> <tr> <th rowspan="2">Signal designation</th> <th colspan="5">Connector</th> </tr> <tr> <th>COMBICON</th> <th>D-SUB 9</th> <th>M12</th> <th>RM45</th> <th>7/8"</th> </tr> </thead> <tbody> <tr> <td>CAN_L</td> <td>2</td> <td>2</td> <td>5</td> <td>2</td> <td>5</td> </tr> <tr> <td>CAN_H</td> <td>4</td> <td>7</td> <td>4</td> <td>1</td> <td>4</td> </tr> <tr> <td>V+</td> <td>5</td> <td>9</td> <td>2</td> <td>8</td> <td>2</td> </tr> <tr> <td>V-</td> <td>1</td> <td>3</td> <td>3</td> <td>3</td> <td>3</td> </tr> <tr> <td>Drain</td> <td>3</td> <td>4</td> <td>1</td> <td>6</td> <td>1</td> </tr> </tbody> </table>	Signal designation	Connector					COMBICON	D-SUB 9	M12	RM45	7/8"	CAN_L	2	2	5	2	5	CAN_H	4	7	4	1	4	V+	5	9	2	8	2	V-	1	3	3	3	3	Drain	3	4	1	6	1	<table border="1"> <thead> <tr> <th>Signal designation</th> <th>Connector</th> </tr> </thead> <tbody> <tr> <td>AS-i+</td> <td>1</td> </tr> <tr> <td>AS-i-</td> <td>3</td> </tr> </tbody> </table>	Signal designation	Connector	AS-i+	1	AS-i-	3	<table border="1"> <thead> <tr> <th rowspan="2">Signal designation</th> <th colspan="2">Connector</th> </tr> <tr> <th>M12</th> <th>7/8"</th> </tr> </thead> <tbody> <tr> <td>DATA+</td> <td>2</td> <td>2</td> </tr> <tr> <td>DATA-</td> <td>1</td> <td>1</td> </tr> <tr> <td>Shield</td> <td>3</td> <td>3</td> </tr> </tbody> </table>	Signal designation	Connector		M12	7/8"	DATA+	2	2	DATA-	1	1	Shield	3	3	<table border="1"> <thead> <tr> <th rowspan="2">Signal designation</th> <th colspan="2">Connector</th> </tr> <tr> <th>M12 - MINI - USB</th> <th>USB</th> </tr> </thead> <tbody> <tr> <td>V_{BUS}</td> <td>1</td> <td>1</td> </tr> <tr> <td>D-</td> <td>2</td> <td>2</td> </tr> <tr> <td>D+</td> <td>3</td> <td>3</td> </tr> <tr> <td>ID</td> <td>4</td> <td></td> </tr> <tr> <td>GND</td> <td>5</td> <td>4</td> </tr> </tbody> </table>	Signal designation	Connector		M12 - MINI - USB	USB	V _{BUS}	1	1	D-	2	2	D+	3	3	ID	4		GND	5	4	<table border="1"> <thead> <tr> <th>Signal designation</th> <th>Connector</th> </tr> </thead> <tbody> <tr> <td>SLD</td> <td>1</td> </tr> <tr> <td>DB</td> <td>2</td> </tr> <tr> <td>DG</td> <td>3</td> </tr> <tr> <td>DA</td> <td>4</td> </tr> </tbody> </table>	Signal designation	Connector	SLD	1	DB	2	DG	3	DA	4
Signal designation		Connector																																																																																													
	COMBICON	D-SUB 9	M12	RM45	7/8"																																																																																										
CAN_L	2	2	5	2	5																																																																																										
CAN_H	4	7	4	1	4																																																																																										
V+	5	9	2	8	2																																																																																										
V-	1	3	3	3	3																																																																																										
Drain	3	4	1	6	1																																																																																										
Signal designation	Connector																																																																																														
AS-i+	1																																																																																														
AS-i-	3																																																																																														
Signal designation	Connector																																																																																														
	M12	7/8"																																																																																													
DATA+	2	2																																																																																													
DATA-	1	1																																																																																													
Shield	3	3																																																																																													
Signal designation	Connector																																																																																														
	M12 - MINI - USB	USB																																																																																													
V _{BUS}	1	1																																																																																													
D-	2	2																																																																																													
D+	3	3																																																																																													
ID	4																																																																																														
GND	5	4																																																																																													
Signal designation	Connector																																																																																														
SLD	1																																																																																														
DB	2																																																																																														
DG	3																																																																																														
DA	4																																																																																														
<table border="1"> <thead> <tr> <th>Wire color</th> <th>Signal</th> </tr> </thead> <tbody> <tr> <td>BU</td> <td>CAN_L</td> </tr> <tr> <td>WH</td> <td>CAN_H</td> </tr> <tr> <td>RD</td> <td>V+</td> </tr> <tr> <td>BK</td> <td>V-</td> </tr> </tbody> </table>	Wire color	Signal	BU	CAN_L	WH	CAN_H	RD	V+	BK	V-	<table border="1"> <thead> <tr> <th>Wire color</th> <th>Signal</th> </tr> </thead> <tbody> <tr> <td>BN</td> <td>AS-i-</td> </tr> <tr> <td>WH</td> <td></td> </tr> <tr> <td>BU</td> <td>AS-i+</td> </tr> <tr> <td>BK</td> <td></td> </tr> </tbody> </table>	Wire color	Signal	BN	AS-i-	WH		BU	AS-i+	BK		<table border="1"> <thead> <tr> <th>Wire color</th> <th>Signal</th> </tr> </thead> <tbody> <tr> <td>OG</td> <td>DATA+</td> </tr> <tr> <td>BU</td> <td>DATA-</td> </tr> <tr> <td colspan="2">Filler litz wire</td> </tr> </tbody> </table>	Wire color	Signal	OG	DATA+	BU	DATA-	Filler litz wire		<table border="1"> <thead> <tr> <th>Wire color</th> <th>Signal</th> </tr> </thead> <tbody> <tr> <td>WHOG</td> <td>D-</td> </tr> <tr> <td>WH</td> <td>V_{BUS}</td> </tr> <tr> <td>OG</td> <td>D+</td> </tr> <tr> <td>n.c.</td> <td>ID</td> </tr> <tr> <td>BK</td> <td>GND</td> </tr> </tbody> </table>	Wire color	Signal	WHOG	D-	WH	V _{BUS}	OG	D+	n.c.	ID	BK	GND	<table border="1"> <thead> <tr> <th>Wire color</th> <th>Signal</th> </tr> </thead> <tbody> <tr> <td>Shield</td> <td>SLD</td> </tr> <tr> <td>WH</td> <td>DB</td> </tr> <tr> <td>YE</td> <td>DG</td> </tr> <tr> <td>BU</td> <td>DA</td> </tr> </tbody> </table>	Wire color	Signal	Shield	SLD	WH	DB	YE	DG	BU	DA																																									
Wire color	Signal																																																																																														
BU	CAN_L																																																																																														
WH	CAN_H																																																																																														
RD	V+																																																																																														
BK	V-																																																																																														
Wire color	Signal																																																																																														
BN	AS-i-																																																																																														
WH																																																																																															
BU	AS-i+																																																																																														
BK																																																																																															
Wire color	Signal																																																																																														
OG	DATA+																																																																																														
BU	DATA-																																																																																														
Filler litz wire																																																																																															
Wire color	Signal																																																																																														
WHOG	D-																																																																																														
WH	V _{BUS}																																																																																														
OG	D+																																																																																														
n.c.	ID																																																																																														
BK	GND																																																																																														
Wire color	Signal																																																																																														
Shield	SLD																																																																																														
WH	DB																																																																																														
YE	DG																																																																																														
BU	DA																																																																																														
Shield on pin		Shield on pin 3																																																																																													
Up to 1000 m depending on the transmission speed; can be increased by using repeaters	Max. 100 m cable length, 300 m with termination resistors, 500 m with repeaters	Max. 1900 m; max. 9500 m when using repeaters depending on the selected cable	5 m per segment	Max. 1200 m; max. 13.2 km with repeaters																																																																																											
www.can-cia.de	www.as-interface.net	www.fieldbus.org	www.usb.org	www.clpa-europe.com																																																																																											
EN 50325-4	EN 50295 and IEC 62026-2	IEC 1158, IEC 61158	Not specified	IEC 61784-1 CPF 8																																																																																											
Plug Socket	Plug Socket	Plug Socket	Plug, type A Socket, type B	Plug Socket																																																																																											
M12, 5-pos., A-coded	M12, 4-pos., A-coded	M12, 4-pos., A-coded	USB, 4-pos.	M12, 4-pos., A-coded																																																																																											
Plug Socket		Plug Socket	Plug Socket																																																																																												
7/8" 16UNF, 5-pos.		7/8" 16UNF, 4-pos.	M12 mini-USB, 5-pos.																																																																																												
Plug Socket																																																																																															
D-SUB 9																																																																																															
See phoenixcontact.net/products	See phoenixcontact.net/products	See phoenixcontact.net/products	See phoenixcontact.net/products	See phoenixcontact.net/products																																																																																											

M12 connector and cable connector, for assembly

new



10 Gbps, IDC QUICKON connection, X-coded



10 Gbps, Piercecon® connection, X-coded



M12 circular connector according to:

Pollution degree	3
Degree of protection	IP65/IP67
Connection method	IDC connection technology
Electrical data	
Rated voltage	57 V DC
Rated current	0.6 A (30 W)
Insulation resistance	≥ 100 MΩ
Transmission characteristics (category)	CAT6 _A
Material data	
Contact material	CuSn
Contact surface material	Ni/Au
Contact carrier material	PA
Inflammability class according to UL 94	V0
Coding	X - data
No. of pos.	8
Temperature data	-40 ... 85 [°C]
Plug/socket	

Technical data

	Ethernet	PROFINET
IEC 61076-2-109	3	3
IP65/IP67	IP65/IP67	IP65/IP67
Connection method	IDC connection technology	IDC connection technology
Electrical data		
Rated voltage	57 V DC	57 V DC
Rated current	0.6 A (30 W)	0.6 A (30 W)
Insulation resistance	≥ 100 MΩ	≥ 100 MΩ
Transmission characteristics (category)	CAT6 _A	CAT6 _A
Material data		
Contact material	CuSn	CuSn
Contact surface material	Ni/Au	Ni/Au
Contact carrier material	PA	PA
Inflammability class according to UL 94	V0	V0
Coding	X - data	X - data
No. of pos.	8	8
Temperature data	-40 ... 85	-40 ... 85

Technical data

	Ethernet
IEC 61076-2-109	2
IP65/IP67	IP65/IP67
Connection method	Piercecon®
Electrical data	
Rated voltage	48 V
Rated current	0.5 A
Insulation resistance	≥ 100 MΩ
Transmission characteristics (category)	CAT6 _A
Material data	
Contact material	CuSn
Contact surface material	Ni/Au
Contact carrier material	PP
Inflammability class according to UL 94	V0
Coding	X - data
No. of pos.	8
Temperature data	-40 ... 85

Ordering data

Description	Order No.	Pcs. / Pkt.	Order No.	Pcs. / Pkt.
	Ethernet		PROFINET	
Connector, CAT6_A, shielded, X-coded, color-coded terminal blocks, cable diameter: 5.0 mm ... 10.0 mm				
Plug, straight	1411043	1	1411044	1
Cable connector, CAT6_A, shielded, X-coded, color-coded terminal blocks, cable diameter: 5.0 mm ... 10.0 mm				
Plug, straight	1414412	1	1414413	1
Connector, CAT6_A, shielded, X-coded, color-coded litz wire manager, cable diameter: 4 mm ... 8 mm				
Plug, straight			1417430	1
Plug, angled			1417443	1

Ordering data

Description	Order No.	Pcs. / Pkt.	Order No.	Pcs. / Pkt.
	Ethernet			
Connector, CAT6_A, shielded, X-coded, color-coded litz wire manager, cable diameter: 4 mm ... 8 mm				
Plug, straight			1417430	1
Plug, angled			1417443	1

Accessories

Stripping tool, for multiple-stage repositioning of shielded conductors

VS-CABLE-STRIP-VARIO	1657407	1
----------------------	---------	---

Accessories

VS-CABLE-STRIP-VARIO	1657407	1
----------------------	---------	---

M12 flush-type connector, with 0.5 m litz wires



Front mounting,
D-coded



Rear mounting,
D-coded



Technical data	
SACC-E-...-4CON-M16/0,5 SCO	
Electrical data	
Nominal voltage U_N	250 V
Rated current	4 A
Transmission characteristics (category)	CAT5 (IEC 11801:2002)
Contact material	CuZn
Material of grip body	-
Inflammability class according to UL 94	V0
Connection method	Individual wires
Insertion/withdrawal cycles	> 100
Temperature data	
Plug/socket	[°C] -25 -40 ... 85 85

Ordering data		
Type	Order No.	Pcs. / Pkt.
Bus system flush-type socket, PROFINET, 4-pos., M12 SPEEDCON, D-coded, front/screw mounting with M16 thread, with 0.5 m TPE litz wire, 4 x 0.34 mm²		
Socket		
Bus system flush-type socket, PROFINET, 4-pos., M12 SPEEDCON, D-coded, front/screw mounting with M16 thread, can be positioned, with 0.5 m TPE litz wire, 4 x 0.34 mm²		
Socket		
Bus system flush-type socket, PROFINET, 4-pos., M12 SPEEDCON, D-coded, rear/screw mounting with Pg9 thread, with 0.5 m TPE litz wire, 4 x 0.34 mm²		
Socket		
SACC-E-FSD-4CON-M16/0,5 SCO	1535202	1
SACC-EC-FSD-4CON-M16/0,5 SCO	1535215	1



Technical data	
SACC-DSI-FSD-4CON...	
Electrical data	
Nominal voltage U_N	250 V
Rated current	4 A
Transmission characteristics (category)	CAT5 (IEC 11801:2002)
Contact material	CuZn
Material of grip body	-
Inflammability class according to UL 94	V0
Connection method	Individual wires
Insertion/withdrawal cycles	≥ 100
Temperature data	
Plug/socket	-25 -40 ... 85 85

Ordering data		
Type	Order No.	Pcs. / Pkt.
SACC-DSI-FSD-4CON-PG9/0,5 SCO	1551529	1

Control cabinet feed-through/bulkhead, M12/RJ45



**Bulkhead,
10 Gbps**



**Bulkhead,
100 Mbps and 1 Gbps**



Technical data

VS-BH-M12FSX-10G-RJ45/...

Electrical data	
Nominal voltage U _N	60 V
Rated current	0.5 A
Transmission characteristics (category)	CAT6 _A
Contact material	Copper alloy
Material of grip body	PA
Inflammability class according to UL 94	V0
Insertion/withdrawal cycles	≥ 100
Temperature data	
Plug/socket	-25 ... 85 [°C]



Technical data

VS-BH-M12FS-8CON-RJ45...

VS-BH-M12FSD-RJ45...

50 V	
1 A	
CAT5 (IEC 11801:2002)	CAT5 (IEC 11801:2002)
Copper alloy	Copper alloy
PA	PA
V0	V0
≥ 100	≥ 100
-25 ... 85	
-25 ... 85	

Ordering data

Description	
Control cabinet feed-through, CAT6_A, M12, 8-pos., X-coded to RJ45 socket	
Socket exit 90°	VS-BH-M12FSX-10G-RJ45/90
Socket exit 180°	VS-BH-M12FSX-10G-RJ45/180
Control cabinet feed-through, M12, 8-pos., A-coded on RJ45 socket	
Socket exit 90°	
Socket exit 180°	
Control cabinet feed-through, M12, 4-pos., D-coded on RJ45 socket	
Socket exit 90°	
Socket exit 180°	

Type	Order No.	Pcs. / Pkt.
VS-BH-M12FSX-10G-RJ45/90	1404548	1
VS-BH-M12FSX-10G-RJ45/180	1404549	1

Ordering data

Type	Order No.	Pcs. / Pkt.
VS-BH-M12FS-8CON-RJ45/ 90	1405057	1
VS-BH-M12FS-8CON-RJ45/180	1405060	1
VS-BH-M12FSD-RJ45/90	1657261	1
VS-BH-M12FSD-RJ45/180	1657494	1

M12 terminal outlets, IP65/67

- Easy installation, thanks to captive cover screws
- Robust design
- Integrated cable management system



Terminal outlet with 2 x M12 slots

Technical data

Electrical data	VS-TO-RO-MCBK-F142...
Transmission characteristics (category)	CAT5 (IEC 11801:2002)
Material data	
Housing material	Aluminum cast alloy, powder-coated
Mechanical data	
Color	Black
Degree of protection	IP65/IP67

Ordering data

Description	Type	Order No.	Pcs. / Pkt.
Terminal outlet, M12, IP65/67, 2 slots, with protective plugs, 2 cable entries			
M12 with 2 x sockets, 8-pos., A-coded	VS-TO-RO-MCBK-F1422/1422	1404304	1
M12 with 2 x socket, 4-pos., D-coded	VS-TO-RO-MCBK-F1421/1421	1404294	1

FO connectors, cables, and panel feed-throughs for POF, PCF, and GOF, IP65/67

- 2.2 mm individual wires made from extremely hard-wearing polyamide chloride (PA)
- Assembled patch cable with test report
- Robust connector, IP65/67



M12 optic connectors



M12 transceiver

ERIC

			Technical data			Technical data		
Material data								
Ferrule material			Copper alloy			-		
Inflammability class according to UL 94			V0			V0		
Degree of protection			IP65/IP67			IP65/IP67		
Cable diameter			7.5 mm ... 8.5 mm			-		
Temperature data								
Ambient temperature (operation)			-20 °C ... 70 °C			-40 °C ... 85 °C		
			Ordering data			Ordering data		
Description	Cable length	Type	Order No.	Pcs. / Pkt.	Type	Order No.	Pcs. / Pkt.	
Assembled FO round cable, 980/1000 µm POF fiber, M12 FO to M12 FO	1 m	FOC-PN-B-1000/M12-C/M12-C/1	1408871	1				
	2 m	FOC-PN-B-1000/M12-C/M12-C/2	1408870	1				
	5 m	FOC-PN-B-1000/M12-C/M12-C/5	1416680	1				
Assembled FO round cable, 980/1000 µm POF fiber, M12 FO to SC-RJ/IP20	1 m	FOC-PN-B-1000/M12-C/SCRJ/1	1408865	1				
	2 m	FOC-PN-B-1000/M12-C/SCRJ/2	1408864	1				
	5 m	FOC-PN-B-1000/M12-C/SCRJ/5	1416648	1				
Assembled FO breakout cable, 200/230 µm PCF-GI fiber, M12 FO to M12 FO	1 m	FOC-HCS-GI-1005/M12-C/M12-C/1	1408873	1				
	2 m	FOC-HCS-GI-1005/M12-C/M12-C/2	1408872	1				
	5 m	FOC-HCS-GI-1005/M12-C/M12-C/5	1416693	1				
Assembled FO round cable, 200/230 µm PCF-GI fiber, M12 FO to SC-RJ/IP20	1 m	FOC-HCS-GI-1005/M12-C/SCRJ/1	1408867	1				
	2 m	FOC-HCS-GI-1005/M12-C/SCRJ/2	1408866	1				
	5 m	FOC-HCS-GI-1005/M12-C/SCRJ/5	1416651	1				
Assembled FO round cable, 50/125 µm GOF-MM fiber, M12 FO to M12 FO	1 m	FOC-M12-M12-GB02/1	1408875	1				
	2 m	FOC-M12-M12-GB02/2	1408874	1				
	5 m	FOC-M12-M12-GB02/5	1416703	1				
Assembled FO round cable, 50/125 µm GOF-MM fiber, M12 FO to LC duplex	1 m	FOC-M12-LC:A-GB02/1	1408869	1				
	2 m	FOC-M12-LC:A-GB02/2	1408868	1				
	5 m	FOC-M12-LC:A-GB02/5	1416664	1				
M12 fiber optic transceiver, duplex, for POF fiber, for PCB mounting, M16 fastening thread, with sealing cap					FOC-M12-MNNA-TC-650	1416716	1	
					FOC-M12-MNNA-TC-1300	1416729	1	
					FOC-M12-BU/BU	1416677	1	
Wavelength: 650 nm Wavelength: 1300 nm M12 fiber optics coupling, duplex, suitable for all fibers, with wall bracket, IP65 degree of protection					FOC-M12-RS-POF	1406421	1	
					FOC-M12-RS-HCS	1406422	1	
					FOC-M12-RS-GOF	1406423	1	
Repair set, 10 replacement ferrules for M12 fiber optic connectors in plastic box For 980/1000 µm POF fiber For 200/230 µm PCF fiber For 50/125 µm GOF fiber								
			Accessories			Accessories		
Ferrule cleaner, approx. 500 cleaning cycles								
2.50 mm, for ST, SC, FC						FOC-TOOL-FERRULECLEANER-2.50	1407029	1

RJ45 connector, IP65/67



RJ45 connector

Technical data

VS-V1-C-RJ45-MNNA-PG9-8-I-5-S

Electrical data	
Rated voltage	50 V
Rated current	1.75 A
Transmission characteristics (category)	CAT5 (IEC 11801:2002)
Surge voltage category	I
Material data	
Housing material	Zinc die-cast
Inflammability class according to UL 94	V0
Pollution degree	2
Connection data	
Connection method	IDC connection
Connection cross section AWG	27 ... 24 (stranded)
External cable diameter	5 mm ... 10 mm
Insertion/withdrawal cycles	750
Temperature data	
Ambient temperature (operation)	-40 °C ... 70 °C

Ordering data

Description	Type	Order No.	Pcs. / Pkt.
RJ45 connector , IP67, with bayonet interlocking, metal housing, CAT5, 8-pos.	VS-V1-C-RJ45-MNNA-PG9-8-I-5-S	1419182	1

Accessories

Stripping tool , for multiple-stage repositioning of shielded conductors	VS-CABLE-STRIP-VARIO	1657407	1
Protective cover , IP67, plastic, for covering the contact insert in the RJ45, LC, and SC-RJ connector	VS-V1-C-PC-POBK	1419183	1

RJ45 panel mounting frame, IP65/67



Panel mounting frame with
RJ45 coupling module



Panel mounting frame with
RJ45 cable connection module

ERIC

Technical data

Electrical data	
Transmission characteristics (category)	CAT5 (IEC 11801:2002)
Housing material	Zinc die-cast
Inflammability class according to UL 94	V0
No. of pos.	8
Connection cross section AWG	-
Insertion/withdrawal cycles	750
Temperature data	
Ambient temperature (operation)	-40 °C ... 70 °C

Ordering data

Description	Type	Order No.	Pcs. / Pkt.
RJ45 panel mounting frame, IP67, for bayonet locking, metal, with socket/socket contact insert, for round mounting cutout, with seal, without mounting screws			
RJ45 panel mounting frame, IP67, for bayonet locking, metal, with contact insert for cable connection, for round mounting cutout, with seal, without mounting screws	VS-V1-F-RJ45-MNNA-1-C-S-JJ-S	1419184	1

Accessories

Protective cover, IP67, plastic, for covering the contact insert in the RJ45, LC, and SC-RJ panel mounting frame	VS-V1-F-PC-POBK	1419186	1
---	-----------------	---------	---

ERIC

Technical data

Electrical data	
Transmission characteristics (category)	CAT5 (IEC 11801:2002)
Housing material	Zinc die-cast
Inflammability class according to UL 94	V0
No. of pos.	8
Connection cross section AWG	26 ... 22 (stranded)
Insertion/withdrawal cycles	750
Temperature data	
Ambient temperature (operation)	-40 °C ... 70 °C

Ordering data

Description	Type	Order No.	Pcs. / Pkt.
RJ45 panel mounting frame, IP67, for bayonet locking, metal, with contact insert for cable connection, for round mounting cutout, with seal, without mounting screws			
RJ45 panel mounting frame, IP67, for bayonet locking, metal, with contact insert for cable connection, for round mounting cutout, with seal, without mounting screws	VS-V1-F-RJ45-MNNA-1-C-S-JI-S	1419185	1

Accessories

Protective cover, IP67, plastic, for covering the contact insert in the RJ45, LC, and SC-RJ panel mounting frame	VS-V1-F-PC-POBK	1419186	1
---	-----------------	---------	---

FO connector and panel mounting frame, for POF, IP65/67



SC-RJ connector



Panel mounting frame with SC-RJ coupling module

ERC

Technical data

VS-V1-C-...-A4A-G

Material data

Housing material

Color

Degree of protection

Cable diameter

Insertion/withdrawal cycles

Temperature data

Ambient temperature (operation)

Zinc die-cast
Silver
IP67
5 mm ... 10 mm
500

-40 °C ... 70 °C

Ordering data

Description

SC-RJ FO connector, IP67, with bayonet interlocking, metal housing, duplex, with adhesive connection technology

For POF fiber

SC-RJ panel mounting frame, IP67, for bayonet interlocking, metal, SC-RJ to 2 x SC, for round mounting cutout, with seal, without mounting screws, with coupling for:

GOF multi mode, POF

Type	Order No.	Pcs. / Pkt.
VS-V1-C-SCRJ-MNNA-PG9-A4A-G	1419189	1

Accessories

Protective cover, IP67, plastic, for covering the contact insert in the RJ45, LC, and SC-RJ connector

Protective cover, IP67, plastic, for covering the contact insert in the RJ45, LC, and SC-RJ panel mounting frame

VS-V1-C-PC-POBK	1419183	1
-----------------	---------	---

ERC

Technical data

VS-V1-F-...-C-S-A1

Zinc die-cast
Silver
IP67
-
500

-40 °C ... 70 °C

Ordering data

Type	Order No.	Pcs. / Pkt.
VS-V1-F-SCRJ-MNNA-PG9-C-S-A1	1420197	1

Accessories

VS-V1-F-PC-POBK	1419186	1
-----------------	---------	---

RJ45 connector, IP65/67

- Compact design
- IP67 protection class
- Push-pull interlocking



RJ45 connector

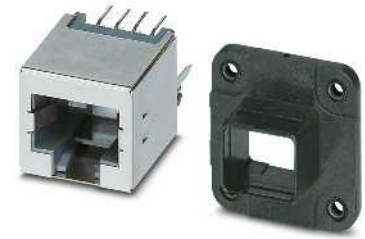

Panel mounting frames and RJ45 modules

	Technical data			Technical data		
Electrical data						
Transmission characteristics (category)	CAT6 _A			CAT5		
Material data						
Housing material	Plastic			Copper alloy		
Inflammability class according to UL 94	V0			V0		
Mechanical data						
No. of pos.	8			8		
Connection method	Crimp connection			Solder connection		
Connection cross section AWG	28 ... 24 (stranded)			-		
Temperature data						
Ambient temperature (operation)	-40 °C ... 70 °C			-40 °C ... 70 °C		
	Ordering data			Ordering data		
Description	Type	Order No.	Pcs. / Pkt.	Type	Order No.	Pcs. / Pkt.
RJ45 connector , IP67, with push-pull interlocking (version 4), plastic housing, for 10 Gbps, for 24 ... 28 AWG stranded conductors	CUC-V04-RJ45-POBK-8	1407413	1			
RJ45 socket insert , 1-way, for PCB mounting, CAT5, 8-pos., shielded				CUC-V04-BU-180	1407409	1
Straight solder pins				CUC-V04-BU-90	1407408	1
Angled solder pins				CUC-V04-F-POBK-180	1407410	1
Panel mounting frame				CUC-V04-F-POBK-90	1407411	1
For 180° socket insert				CUC-V04-F-BU/BU-RJ45	1407412	1
For 90° socket insert						
Panel mounting frame set						
Socket/socket						
	Accessories			Accessories		
Stripping tool , for multiple-stage repositioning of shielded conductors	VS-CABLE-STRIP-VARIO	1657407	1			
Electronic diagonal cutter , tapered head, without chamfer, with opening spring, non-reflective phosphate-treated surface, punched version	MICROFOX-SP-1	1212487	1			
Crimping pliers , for assembling the RJ45 connectors	FL CRIMPTOOL	2744869	1			

RJ45 connector, IP65/67



RJ45 connector



RJ45 connector with field and crimp connection

Technical data	
Electrical data	VS-08-RJ45-5-Q/IP67...
Rated voltage	50 V
Rated current	1.75 A
Transmission characteristics (category)	CAT5 (IEC 11801:2002)
Surge voltage category	I
Material data	
Housing material	PA
Contact material	Copper alloy
Inflammability class according to UL 94	V0
Pollution degree	2
Connection data	
Connection method	IDC fast connection
Connection cross section AWG	26 ... 24 (solid)
Connection cross section AWG	26 ... 24 (stranded)
External cable diameter	5 mm ... 8 mm
Insertion/withdrawal cycles	≥ 1000
Temperature data	
Ambient temperature (operation)	-20 °C ... 70 °C

Technical data	
Electrical data	VS-08-T-H-RJ45...
Rated voltage	-
Rated current	-
Transmission characteristics (category)	-
Surge voltage category	-
Material data	
Housing material	PA
Contact material	-
Inflammability class according to UL 94	V0
Pollution degree	-
Connection data	
Connection method	-
Connection cross section AWG	-
Connection cross section AWG	-
External cable diameter	5 mm ... 8.5 mm
Insertion/withdrawal cycles	≥ 1000
Temperature data	
Ambient temperature (operation)	-40 °C ... 80 °C

Technical data	
Electrical data	VS-08-ST-H...-RJ45
Rated voltage	125 V
Rated current	0.5 A
Transmission characteristics (category)	-
Surge voltage category	I
Material data	
Housing material	PA
Contact material	-
Inflammability class according to UL 94	V2
Pollution degree	2
Connection data	
Connection method	IDC connection technology
Connection cross section AWG	27 ... 26 (stranded)
Connection cross section AWG	-
External cable diameter	-
Insertion/withdrawal cycles	≥ 750
Temperature data	
Ambient temperature (operation)	-25 °C ... 60 °C

Ordering data	
Description	Type
RJ45 connector , 8-pos., with QUICKON fast connection technology, for 26 ... 24 AWG Military gray RAL 7042 Deep black RAL 9005	VS-08-RJ45-5-Q/IP67
Sleeve housing , for VS-08-ST-H...-RJ45 pin insert, for cable diameter of 5.0 mm ... 8.5 mm Military gray RAL 7042 Deep black RAL 9005	VS-08-RJ45-5-Q/IP67-BK
RJ45 pin insert , 8-pos., shielded, IDC connection technology, for 27 ... 26 AWG litz wires, with strain relief CAT5 CAT6	
RJ45 pin insert , 8-pos., shielded, IDC pierce connection, for litz wires AWG 27 ... 24, with strain relief CAT6	
RJ45 pin insert , CAT6 _A , 10 Gbps	

Ordering data	
Description	Type
RJ45 connector , 8-pos., with QUICKON fast connection technology, for 26 ... 24 AWG Military gray RAL 7042 Deep black RAL 9005	VS-08-RJ45-5-Q/IP67
Sleeve housing , for VS-08-ST-H...-RJ45 pin insert, for cable diameter of 5.0 mm ... 8.5 mm Military gray RAL 7042 Deep black RAL 9005	VS-08-RJ45-5-Q/IP67-BK
RJ45 pin insert , 8-pos., shielded, IDC connection technology, for 27 ... 26 AWG litz wires, with strain relief CAT5 CAT6	
RJ45 pin insert , 8-pos., shielded, IDC pierce connection, for litz wires AWG 27 ... 24, with strain relief CAT6	
RJ45 pin insert , CAT6 _A , 10 Gbps	

Ordering data	
Description	Type
RJ45 connector , 8-pos., with QUICKON fast connection technology, for 26 ... 24 AWG Military gray RAL 7042 Deep black RAL 9005	VS-08-RJ45-5-Q/IP67
Sleeve housing , for VS-08-ST-H...-RJ45 pin insert, for cable diameter of 5.0 mm ... 8.5 mm Military gray RAL 7042 Deep black RAL 9005	VS-08-RJ45-5-Q/IP67-BK
RJ45 pin insert , 8-pos., shielded, IDC connection technology, for 27 ... 26 AWG litz wires, with strain relief CAT5 CAT6	
RJ45 pin insert , 8-pos., shielded, IDC pierce connection, for litz wires AWG 27 ... 24, with strain relief CAT6	
RJ45 pin insert , CAT6 _A , 10 Gbps	

Accessories	
Stripping tool , for multiple-stage repositioning of shielded conductors	VS-CABLE-STRIP-VARIO
Crimp tool , pliers with die, for VS-08-ST-H...-RJ45	

Accessories	
Stripping tool , for multiple-stage repositioning of shielded conductors	VS-CABLE-STRIP-VARIO
Crimp tool , pliers with die, for VS-08-ST-H...-RJ45	

Accessories	
Stripping tool , for multiple-stage repositioning of shielded conductors	VS-CABLE-STRIP-VARIO
Crimp tool , pliers with die, for VS-08-ST-H...-RJ45	VS-CT-RJ45-H

RJ45 panel mounting frames and Freetnet socket inserts, IP65/67



Keystone panel mounting frames and keystones

Freetnet panel mounting frames and modules

	Technical data			Technical data		
	VS-08-BU-RJ45-6/KA/LSA			VS-08-BU-RJ45/10G-F	VS-A-F-IP67	
Electrical data						
Nominal voltage U _N	250 V AC			50 V	-	
Rated current	2 A			1 A	-	
Housing material	Nickel-plated brass			Copper alloy	PA	
Contact material	Copper alloy			CuSn	-	
Inflammability class according to UL 94	V0			V0	V0	
No. of pos.	8			8	-	
Connection method	LSA			IDC	-	
Insertion/withdrawal cycles	≥ 1000			≥ 750	≥ 1000	
Temperature data						
Ambient temperature (operation)	-20 °C ... 70 °C			-10 °C ... 60 °C	-40 °C ... 80 °C	
	Ordering data			Ordering data		
Description	Type	Order No.	Pcs. / Pkt.	Type	Order No.	Pcs. / Pkt.
RJ45 socket insert , 8-pos., shielded, with cable connection						
CAT6	VS-08-BU-RJ45-6/KA/LSA	1653168	5			
RJ45 socket insert , 8-pos., shielded, socket to socket						
CAT5	VS-08-BU-RJ45/BU	1689064	5			
CAT6	VS-08-BU-RJ45-6-MOD/BU	1653155	5			
RJ45 keystone panel mounting frame , Version 6, for round mounting cutout, with seal and central nut						
Military gray RAL 7042	VS-08-A-RJ45/MOD-1-R-IP67	1689844	1			
Deep black RAL 9005	VS-08-A-RJ45/MOD-1-R-IP67 BK	1658053	5			
RJ45 keystone panel mounting frame , Version 6, with rectangular mounting cutout, with seal, without mounting screws						
Military gray RAL 7042	VS-08-A-RJ45/MOD-1-IP67	1689080	5			
Deep black RAL 9005	VS-08-A-RJ45/MOD-1-IP67-BK	1658642	5			
RJ45 Freetnet socket insert , 8-pos., shielded, with cable connection				VS-08-BU-RJ45/10G-F	1424009	1
10 Gbps, CAT6 _A				VS-08-BU-RJ45-5-F/PK	1652936	1
RJ45 Freetnet socket insert , 8-pos., shielded, with cable connection						
1 Gbps, CAT5				VS-08-BU/BU-RJ45-F	1405617	1
RJ45 Freetnet socket insert , 8-pos., shielded, socket to socket						
1 Gbps, CAT5				VS-A-F-IP67	1653744	5
Freetnet panel mounting frame , Version 6, for round mounting cutout, with seal, without mounting screws				VS-A-F-IP67-BK	1658668	5
Military gray RAL 7042						
Deep black RAL 9005						
	Accessories			Accessories		
Protective cover for Version 6 panel mounting frame				VS-08-SD-F	1652606	5
Military gray RAL 7042	VS-08-SD-F	1652606	5	VS-08-SD-F-BK	1658066	5
Deep black RAL 9005	VS-08-SD-F-BK	1658066	5	VS-CABLE-STRIP-VARIO	1657407	1
Stripping tool , for multiple-stage repositioning of shielded conductors	VS-CABLE-STRIP-VARIO	1657407	1			

RJ45 terminal outlets, IP65/IP67

- Robust design
- Including covers to protect against environmental influences
- Integrated cable management system



Terminal outlet with 2 x RJ45 slots

Technical data

Electrical data	VS-TO-RO-MCBK-F141...
Transmission characteristics (category)	CAT5
Material data	
Housing material	Aluminum cast alloy, powder-coated
Mechanical data	
Color	Black
Degree of protection	IP65/IP67

Ordering data

Description	Type	Order No.	Pcs. / Pkt.
Terminal outlet RJ45 IP65/67, 2 slots version 6, with protective plugs, 2 cable entries 2x RJ45	VS-TO-RO-MCBK-F1418/1418	1404278	1

Field coupling, IP65/IP67

- Fixed mounting is also an option
- Including covers to protect against environmental influences



Field coupling with RJ45



Technical data

VS-08-KU-IP67

Electrical data	
Rated voltage	50 V
Rated current	1 A
Transmission characteristics (category)	CAT5 (IEC 11801:2002)
Material data	
Housing material	PBT
Contact material	Copper alloy
Inflammability class according to UL 94	V0
Mechanical data	
No. of pos.	8
Degree of protection	IP65/IP67
Temperature data	
Ambient temperature (operation)	-10 °C ... 60 °C

Ordering data

Description	Type	Order No.	Pcs. / Pkt.
RJ45 coupling, IP67, CAT5, with protective cover			
Military gray RAL 7042	VS-08-KU-IP67	1689268	1
Deep black RAL 9005	VS-08-KU-IP67-BK	1658684	1

FO connectors, IP65/67

Notes:

For further technical data, see:
phoenixcontact.net/products



**SC-RJ connector
for polymer fiber 980/1000 µm**

ERC

Material data
Housing material
Ferrule material
Inflammability class according to UL 94
Color
Degree of protection
External cable diameter
Wire diameter
Ferrule diameter
Insertion/withdrawal cycles
Temperature data
Ambient temperature (operation)

Technical data	
PA	
Copper alloy	
V0	
Gray	
IP67	
5 mm ... 8.5 mm	
2.2 mm	
2.50 mm	
≥ 1000	
-20 °C ... 70 °C	

Description
FO connector SC-RJ , duplex, with fast connection
POF fiber 980/1000 µm
PCF fiber 200/230 µm
GOF, 50/125 µm, multi mode
SC-RJ socket insert , duplex, for VARIOSUB IP67 panel mounting frame, can be used for GOF multi mode, GOF single mode, PCF, and POF fiber types
- 1 x SC-RJ/SC-RJ (duplex)
VS-SC-RJ panel mounting frame , for use with an AVAGO transceiver, type: AFBR 5978Z
Freet panel mounting frame , version 6, for round mounting cutout, with seal, without mounting screws
Military gray RAL 7042
Deep black RAL 9005

Ordering data		
Type	Order No.	Pcs. / Pkt.
VS-SCRJ-POF-FA-IP67	1657009	1

Protective cover SC-RJ/IP67 , for covering the SC-RJ pin insert on the SC-RJ/IP67 sleeve housing
Protective cover for version 6 panel mounting frame
Military gray RAL 7042
Deep black RAL 9005
Tool set for POF assembly , for field installation of SC connectors
Tool set for PCF assembly , for field installation of SC connectors
Tool set for GOF assembly , for field installation of LC and SC connectors

Accessories		
Type	Order No.	Pcs. / Pkt.
VS-SCRJ-PC	1653757	5
TF-SCRJ-POF KONF SET	1405246	1



SC-RJ connector
for PCF fiber 200/230 μm



SC-RJ connector
for 50/125 μm multi mode fiberglass



Panel mounting frame
and SC-RJ coupling module

®

ERIC

ERIC

Technical data
PA
Copper alloy
V0
Gray
IP67
5 mm ... 8.5 mm
2.9 mm
2.50 mm
≥ 1000
-20 °C ... 70 °C

Technical data
PA
Zirconia ceramics
V0
Gray
IP67
5 mm ... 8.5 mm
2.9 mm
2.50 mm
≥ 1000
-20 °C ... 70 °C

Technical data
PBT
Zirconia ceramics
V0
Black
IP20
-
2.50 mm
≥ 500
-25 °C ... 70 °C

Ordering data		
Type	Order No.	Pcs. / Pkt.
VS-SCRJ-HCS-FA-IP67	1657012	1

Ordering data		
Type	Order No.	Pcs. / Pkt.
VS-SCRJ-GOF-FA-IP67	1657083	1

Ordering data		
Type	Order No.	Pcs. / Pkt.
VS-SCRJ-GOF-BU/BU	1652978	1
VS-SCRJ-A-TC-IP67	1658545	1
VS-A-F-IP67	1653744	5
VS-A-F-IP67-BK	1658668	5

Accessories		
Type	Order No.	Pcs. / Pkt.
VS-SCRJ-PC	1653757	5
FOC-TOOL-PCF KONF SET	1411051	1

Accessories		
Type	Order No.	Pcs. / Pkt.
VS-SCRJ-PC	1653757	5
FOC-TOOL-GOF KONF SET	1411049	1

Accessories		
Type	Order No.	Pcs. / Pkt.
VS-08-SD-F	1652606	5
VS-08-SD-F-BK	1658066	5

SC-RJ terminal outlet, IP65/67

- Easy installation, thanks to captive cover screws
- Robust design
- Including covers to protect against environmental influences
- Integrated cable management system



**Terminal outlet, IP67,
with 2 x SC-RJ slots**

Technical data

Material data	
Housing material	Aluminum cast alloy, powder-coated
Ferrule material	
	Zirconia ceramics
Mechanical data	
Color	Black
Degree of protection	IP65/IP67
Fiber type	GOF, HCS, POF
Connection profile	SCRJ according to DIN EN 50377-6-1
Insertion/withdrawal cycles	≥ 500

Ordering data

Description	Ordering data		
	Type	Order No.	Pcs. / Pkt.
Terminal outlet SC-RJ IP65/67, 2 slots version 6, with protective plugs, 2 cable entries	VS-TO-RO-MCBK-F1420/1420	1404317	1

**SC-RJ coupling,
IP65/67**

- Fixed mounting is also an option
- Including covers to protect against environmental influences
- Can be used for all fiber types

**SC-RJ field coupling****Technical data**

Material data	
Housing material	PBT
Contact material	-
Ferrule material	Zirconia ceramics
Inflammability class according to UL 94	V0
Mechanical data	
No. of pos.	2
Color	Gray
Degree of protection	IP65/IP67
Temperature data	
Ambient temperature (operation)	-10 °C ... 60 °C

Ordering data

Description	Type	Order No.	Pcs. / Pkt.
	SC-RJ coupling , IP67, duplex, can be used for GOF (multi mode and single mode), PCF, and polymer fiber types	FOC-V06-D1PGY-S/SJBE4	1410050

Push-pull ADVANCE connector, IP65/67

- High resistance to ESD and EMI for reliable transmission
- Easy handling, thanks to one-piece design
- Locking system to prevent unintentional removal
- Consistent 360° shielding concept



RJ45 connector, straight cable outlet



RJ45 connector, cable outlet at the top

	Technical data				Technical data			
Degree of protection	Ethernet IP65/IP67		PROFINET IP65/IP67		Ethernet IP65/IP67		PROFINET IP65/IP67	
Connection cross section AWG	26 ... 24 (solid)		23 ... 22 (solid)		26 ... 24 (solid)		23 ... 22 (solid)	
Transmission speed	10 Gbps		10 Gbps		10 Gbps		10 Gbps	
Housing material	Zinc die-cast		Zinc die-cast		Zinc die-cast		Zinc die-cast	
External cable diameter	5.5 mm ... 10 mm		5.5 mm ... 10 mm		5.5 mm ... 10 mm		5.5 mm ... 10 mm	
Insertion/withdrawal cycles	≥ 750		≥ 750		≥ 750		≥ 750	
Temperature data								
Ambient temperature (operation)	-40 °C ... 70 °C		-40 °C ... 70 °C		-40 °C ... 70 °C		-40 °C ... 70 °C	
	Ordering data				Ordering data			
Description	Order No.	Pcs. / Pkt.	Order No.	Pcs. / Pkt.	Order No.	Pcs. / Pkt.	Order No.	Pcs. / Pkt.
	Ethernet		PROFINET		Ethernet		PROFINET	
Push-pull ADVANCE , RJ45 industrial connector, IP67, 8-pos.								
Single pack	1407890	1	1407889	1	1468007	1	1408027	1
Pack of 10	1467901	1	1408039	1	1467807	1	1408092	1
	Accessories				Accessories			
Stripping tool , for multiple-stage repositioning of shielded conductors	VS-CABLE-STRIP-VARIO	1657407	1		VS-CABLE-STRIP-VARIO	1657407	1	
	MICROFOX-SP-1	1212487	1		MICROFOX-SP-1	1212487	1	
Electronic diagonal cutter , tapered head, without chamfer, with opening spring, non-reflective phosphate-treated surface, punched version								

Push-pull ADVANCE connector, IP65/67



RJ45 connector, cable outlet at the bottom



RJ45 connector

ERIC

Degree of protection
Connection cross section AWG
Transmission speed
Housing material
External cable diameter
Insertion/withdrawal cycles
Temperature data
Ambient temperature (operation)

Technical data	
Ethernet	PROFINET
IP65/IP67	IP65/IP67
26 ... 24 (solid)	23 ... 22 (solid)
10 Gbps	10 Gbps
Zinc die-cast	Zinc die-cast
5.5 mm ... 10 mm	5.5 mm ... 10 mm
≥ 750	≥ 750
-40 °C ... 70 °C	-40 °C ... 70 °C

Technical data	
IP65/IP67	IP65/IP67
27 ... 24 (stranded)	26 ... 22 (solid)
10 Gbps	-
Plastic	PA-GF
5 mm ... 8 mm	5 mm ... 8 mm
≥ 200	≥ 500
-25 °C ... 60 °C	-10 °C ... 60 °C

Description	Push-pull ADVANCE, RJ45 industrial connector, IP67, 8-pos.
Single pack	1
Pack of 10	1
Push-pull connector (version 14) for 10 Gbps, with RJ45 crimp connection, for 26 ... 24 AWG stranded conductors, 5.0 mm ... 8.0 mm cable diameter	
Plastic housings	
Push-pull connector (version 14) for PROFINET with RJ45 QUICKON fast connection technology, for 22 AWG 1 and 7-wire conductors, cable diameter of 5.0 mm ... 8.0 mm	
4-pos., 100 Mbps	1
8-pos., 1 Gbps	1

Ordering data			
Order No.	Pcs. / Pkt.	Order No.	Pcs. / Pkt.
Ethernet		PROFINET	
1408011	1	1407895	1
1467804	1	1408046	1

Ordering data			
Order No.	Pcs. / Pkt.	Order No.	Pcs. / Pkt.
1422205	1		

Stripping tool , for multiple-stage repositioning of shielded conductors	
Electronic diagonal cutter , tapered head, without chamfer, with opening spring, non-reflective phosphate-treated surface, punched version	
Protective cover, IP65 , with push-pull locking, for covering the contact insert in the push-pull connector for RJ45 and SC-RJ, plastic	
Shielding foil set , 25 pcs., replacement for VS-PN-RJ45-5-Q/IP20	

Accessories		
VS-CABLE-STRIP-VARIO	1657407	1
MICROFOX-SP-1	1212487	1

Accessories		
VS-CABLE-STRIP-VARIO	1657407	1
VS-PPC-F1-PC-POBK	1405316	1
VS-08-RJ45-FOLIEN-SET	1417184	1

RJ45 panel mounting frames and Freenet socket inserts, IP65/67



Freenet panel mounting frames and modules



Freenet panel mounting frame with central nut and modules

	Technical data			Technical data		
	VS-08-BU-RJ45/10G-F			VS-08-BU-RJ45-5-F/PK		
Electrical data						
Nominal voltage U_N	50 V			50 V		
Rated current	1 A			1 A		
Housing material	Copper alloy			Copper alloy		
Contact material	CuSn			Copper alloy		
Inflammability class according to UL 94	V0			V0		
No. of pos.	8			8		
Connection method	IDC			IDC		
Insertion/withdrawal cycles	≥ 750			≥ 750		
Temperature data						
Ambient temperature (operation)	-10 °C ... 60 °C			-20 °C ... 70 °C		
	Ordering data			Ordering data		
Description	Type	Order No.	Pcs. / Pkt.	Type	Order No.	Pcs. / Pkt.
RJ45 Freenet socket insert , 8-pos., shielded, with cable connection 10 Gbps, CAT6 _A	VS-08-BU-RJ45/10G-F	1424009	1	VS-08-BU-RJ45/10G-F	1424009	1
RJ45 Freenet socket insert , 8-pos., shielded, with cable connection 1 Gbps, CAT5	VS-08-BU-RJ45-5-F/PK	1652936	1	VS-08-BU-RJ45-5-F/PK	1652936	1
RJ45 Freenet socket insert , 8-pos., shielded, socket to socket 1 Gbps, CAT5	VS-08-BU/BU-RJ45-F	1405617	1	VS-08-BU/BU-RJ45-F	1405617	1
RJ45 Freenet panel mounting frame , version 14, IP65/IP67, for rectangular mounting cutout, with seal, without mounting screws	VS-PPC-F1-RJ45-MNNA-1R-F	1405358	1			
Metal housing	VS-PPC-F1-RJ45-POBK-1R-F	1608197	1			
Plastic housings						
RJ45 Freenet panel mounting frame , version 14, IP65/IP67, for round mounting cutout, with seal and central nut						
Metal housing				VS-PPC-F1-RJ45-MNNA-1C-F	1405222	1
	Accessories			Accessories		
Protective cover for data port	VS-PPC-C1-PC-ROBK-L	1405293	1	VS-PPC-C1-PC-ROBK-L	1405293	1
Stripping tool, for multiple-stage repositioning of shielded conductors	VS-CABLE-STRIP-VARIO	1657407	1	VS-CABLE-STRIP-VARIO	1657407	1

Field couplings,
IP65/67



RJ45 and power field coupling
with cable connection



RJ45 field coupling
with cable connection

	Technical data			Technical data		
Electrical data	VS-MP-PPC/CG-PO/10G			VS-MP-PPC/CG-10G		
Transmission characteristics (category)	CAT6 _A			CAT6 _A		
Material data	Aluminum press-drawn section / die-cast zinc			Aluminum press-drawn section / die-cast zinc		
Connection data	Spring connection / IDC			IDC		
Connection method	-			-		
Connection cross section AWG	5 mm ... 8 mm (data cable gland)			5 mm ... 8 mm (data cable gland)		
Cable diameter	> 1000 (data)			> 1000 (data)		
Insertion/withdrawal cycles	-			-		
Temperature data	-40 °C ... 70 °C			-40 °C ... 70 °C		
Ambient temperature (operation)						
	Ordering data			Ordering data		
Description	Type	Order No.	Pcs. / Pkt.	Type	Order No.	Pcs. / Pkt.
Multi-port connection , for passive PROFINET cabling to robots, including mounting foot	VS-MP-PPC/CG-PO/10G	1403682	1	VS-MP-PPC/CG-10G	1403678	1
Multi-port power connection : push-pull power, for passive PROFINET cabling to robots, including mounting foot	VS-MP-PPC/CG-PO	1403681	1			
	Accessories			Accessories		
Protective cover	VS-PPC-C1-PC-ROBK-L	1405293	1	VS-PPC-C1-PC-ROBK-L	1405293	1
For data port	VS-PPC-C2-PC-ROBK-L	1405303	1	VS-PPC-C2-PC-ROBK-L	1405303	1
For power port	VS-CABLE-STRIP-VARIO	1657407	1	VS-CABLE-STRIP-VARIO	1657407	1
Stripping tool , for multiple-stage repositioning of shielded conductors						

Power and data field couplings, IP65/67

- Fixed mounting is also an option
- Robust design
- Including covers to protect against environmental influences



RJ45 and power field coupling

ERC

Technical data

VS-MP-PPC/PPC-1G

Electrical data	
Rated voltage	-
Rated current	-
Transmission characteristics (category)	CAT5
Material data	
Housing material	Aluminum press-drawn section / die-cast zinc
Contact material	Phosphor bronze
Inflammability class according to UL 94	V0
Mechanical data	
No. of pos.	8
Degree of protection	IP65
Temperature data	
Ambient temperature (operation)	-

Ordering data

Description	Type	Order No.	Pcs. / Pkt.
Multi-port data coupling: for passive PROFINET cabling to robots, including mounting foot Metal housing	VS-MP-PPC/PPC-1G	1403685	1
Multi-port power coupling: for passive PROFINET cabling to robots, including mounting foot	VS-MP-PPC/PPC-PO	1403684	1

**Terminal outlets,
IP65/67**

- Easy installation, thanks to captive cover screws
- Robust design
- Including covers to protect against environmental influences
- Integrated cable management system



**Terminal outlet
with 2 x RJ45 slots**



**Terminal outlet
with RJ45 and power slots**

	Technical data			Technical data		
Electrical data						
Rated voltage	-			-		
Rated current	-			-		
Transmission characteristics (category)	CAT6			CAT6		
Material data						
Housing material	Aluminum cast alloy, powder-coated			Aluminum cast alloy, powder-coated		
Mechanical data						
Color	Black			Black		
Degree of protection	IP65/IP67			IP65/IP67		
	Ordering data			Ordering data		
Description	Type	Order No.	Pcs. / Pkt.	Type	Order No.	Pcs. / Pkt.
Terminal outlet, IP65/IP67, 2 slots, version 14, with protective plugs, 2 cable entries Push-pull with 2 x RJ45	VS-TO-RO-MCBK-F1411/1411	1404281	1			
Terminal outlet, IP65/IP67, 2 slots, version 14, with protective plugs, 2 cable entries Push-pull with 1 x Power and 1 x RJ45				VS-TO-RO-MCBK-F1411/1413	1404333	1

Push-pull power connector, IP65/67

- Fixed coding for PROFINET
- Flexible coding (on request)
- Various solder versions
- Spring connection



Push-pull connector



Push-pull panel mounting side

	Technical data			Technical data		
	VS-PPC-C2-MSTB-MNNA...			VS-MSTBA...-BK-A	VS-PPC-F2-MSTB-MNNA...	
Electrical data						
Rated current	16 A			16 A	-	
Material data						
Housing material	Zinc die-cast			-	Zinc die-cast	
Inflammability class according to UL 94	V0			V0	V0	
Conductor cross section	0.75 mm ² ... 2.5 mm ²			-	-	
Connection cross section AWG	18 ... 13			-	-	
Insertion/withdrawal cycles	≤ 100			≥ 100	≥ 500	
Temperature data						
Ambient temperature (operation)	-40 °C ... 70 °C			-40 °C ... 70 °C	-40 °C ... 80 °C	
	Ordering data			Ordering data		
Description	Type	Order No.	Pcs. / Pkt.	Type	Order No.	Pcs. / Pkt.
Connector MSTB, IP67 , with a push-pull interlock, 5-pos., with a spring, for cable diameter 9.0 mm ... 13.0 mm						
Metal housing, 24 V	VS-PPC-C2-MSTB-MNNA-P13-A5-SP	1608074	1			
Plastic housing, 24 V	VS-PPC-C2-MSTB-POBK-P13-A5-SP	1657892	1			
Plastic housing, 400 V	VS-PPC-C2-MSTB-POBK-P13-B5-SP	1608236	1			
MSTB contact insert , for PCB mounting, 24 V, 5-pos., RAL 9005 (black), for VS-PPC-F2-MSTB-...-1R-P panel mounting frame						
Angled solder pins				VS-MSTBAH 2,5/ 5-GB-5,08-BK-A	1657915	50
Straight solder pins				VS-MSTBVA 2,5/ 5-GB-5,08-BK-A	1609565	50
MSTB contact insert , for PCB mounting, 400 V, 5-pos., RAL 3000 (red), for VS-PPC-F2-MSTB-...-1R-P panel mounting frame						
Angled solder pins				VS-MSTBAH 2,5/ 5-GB-5,08-RD-B	1609549	50
Straight solder pins				VS-MSTBVA 2,5/ 5-GB-5,08-RD-B	1609581	50
MSTB panel mounting frame, IP67 , for Push-pull locking, for PCB connection, for rectangular assembly opening, with gasket, without mounting screws						
Metal housing				VS-PPC-F2-MSTB-MNNA-1R-P	1608087	1
Plastic housing				VS-PPC-F2-MSTB-POBK-1R-P	1608281	1
MSTB panel mounting frame, IP67 , for push-pull locking, with an integrated contact insert for conductor connection, spring connection, for rectangular mounting cutout, with seal, without mounting screws						
24 V, plastic				VS-PPC-F2-MSTB-POBK-1R-SPSA5	1608294	1
400 V, plastic				VS-PPC-F2-MSTB-POBK-1R-SPSB5	1608304	1
24 V, metal				VS-PPC-F2-MSTB-MNNA-1R-SPSA5	1608249	1
400 V, metal				VS-PPC-F2-MSTB-MNNA-1R-SPSB5	1608252	1
MSTB panel mounting frame, IP67 , for push-pull locking, metal, with an integrated contact insert for conductor connection, spring, for round mounting cutout, with seal, without mounting screws						
24 V				VS-PPC-F2-MSTB-MNNA-1C-SPSA5	1405248	1
400 V				VS-PPC-F2-MSTB-MNNA-1C-SPSB5	1405167	1
Protective cover, IP67 , to cover the contact insert in the push-pull panel mounting frame Power						
Metal housing				VS-PPC-C2-PC67-MNNA	1404045	1
Protective cover						
For power port				VS-PPC-C2-PC-ROBK-L	1405303	1
Protective cap, IP65 , with push-pull locking for covering the contact insert in the push-pull connector for Power, plastic						
				VS-PPC-F2-PC-POBK	1405329	1

Push-pull power distributor, IP65/67



Push-pull Y-distributor



Push-pull H-distributor

	Technical data			Technical data		
Electrical data	VS-PPC-J-1220-1227-1020-0,2			VS-PPC-J-4X-1227		
Rated voltage	24 V			24 V		
Rated current	16 A			16 A		
Material data	Aluminum die-cast			Zinc die-cast		
Housing material	Aluminum die-cast			Zinc die-cast		
Mechanical data	5			5		
No. of pos.	5			5		
Degree of protection	IP65/IP67			IP65/IP67		
Temperature data	-40 °C ... 70 °C (cable, fixed installation)			-40 °C ... 70 °C		
Ambient temperature (operation)	-40 °C ... 70 °C (cable, fixed installation)			-40 °C ... 70 °C		
	Ordering data			Ordering data		
Description	Type	Order No.	Pcs. / Pkt.	Type	Order No.	Pcs. / Pkt.
PROFINET Y-distributor with assembled power cable, 5-pos., IP65/IP67, MSTB connector with metal housing to 2 x socket in the metal housing, cable length:						
0.2 m	VS-PPC-J-1220-1227-1020-0,2	1404799	1			
Variable	VS-PPC-J-1220-1227-1020-...	1405484	1			
PROFINET Y-distributor with assembled power cable, 5-pos., IP65/IP67, 7/8" connector with metal housing to 2 x socket in the metal housing, cable length:						
0.2 m	VS-PPC-J-1226-1227-1021-0,2	1404812	1			
Variable	VS-PPC-J-1226-1227-1021-...	1405497	1			
Power H distributor , 4 x MSTB contact inserts, metal housing, without mounting screws				VS-PPC-J-4X-1227	1405387	1
	Accessories			Accessories		
Mounting foot for power distributors, plastic	VS-PPC-J-M	1405390	1	VS-PPC-J-M	1405390	1

Ordering example for articles with variable cable:

For a distributor with a cable length of 34.5 m, the order data is as follows:

Order No.	Length [m]
1405484	34.5
	Increment: 0.5 m; Maximum length: 50 m

Data connectors and cables

Network components - version 14 connectors

Assembled POWER cables 2.5 mm²

Power, metal,
24 V

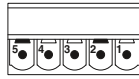



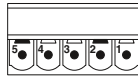

Power, plastic,
24 V

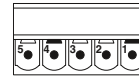

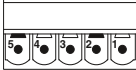
Power, plastic,
400 V

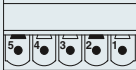

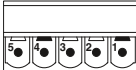
		Ordering data	Ordering data	Ordering data	Ordering data	Ordering data
		Order No.	Order No.	Order No.	Order No.	Order No.
Power, metal, 24 V  	1 m	1609170				
	2 m	1609183				
	5 m	1609196				
	Variable	1609206				
Power, plastic, 24 V  	1 m	1609251				
	2 m	1609264				
	5 m	1609277				
	Variable	1609280				
Power, plastic, 400 V  	1 m	1609374				
	2 m	1609387				
	5 m	1609390				
	Variable	1609400				

Ordering example for cable with variable cable length:

Assembled PROFINET Power cable for 24 V, with two push-pull connectors in metal design and a cable length of 34.5 m.

Order No.	Length [m] Max. 100 m
1609206	34.5
1609280 1609400	Increments: 1.0 m ... 3.0 m = 0.1 m > 3.0 m = 0.5 m

Technical data	Technical data	Technical data	Technical data
	Power, metal, 24 V	Power, plastic, 24 V	Power, plastic, 400 V
Housing material	Zinc die-cast	PA-GF	PA-GF
Outer sheath, material	PVC	PVC	PVC
Conductor cross section [mm ²]	2.5	2.5	2.5
External cable diameter [mm]	11.8	11.8	11.8
Degree of protection	IP65/IP67	IP65/IP67	IP65/IP67
Ambient temperature			
Fixed installation [°C]	-40 ... 70	-40 ... 70	-40 ... 70
Flexible installation [°C]	-5 ... 70	-5 ... 70	-5 ... 70
Plug/socket [°C]	-40 ... 70	-40 ... 70	-40 ... 70

**Assembled POWER cables
1.5 mm²**

Power, metal,
24 V

Power, plastic,
24 V

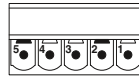
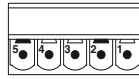

Ordering data		Ordering data		Ordering data	
	Order No.		Order No.		Order No.
1 m	1609219	1 m	1609293		
2 m	1609222	2 m	1609303		
5 m	1609235	5 m	1609316		
Variable	1609248	Variable	1609329		

Power, 7/8"



**Ordering example for cable with
variable cable length:**

Assembled PROFINET Power cable for 24 V, with one push-pull connector in metal design and a 7/8" connector and a cable length of 34.5 m.

Order No.	Length [m] Max. 100 m
1609248 / 1609329	34.5
Increments: 1.0 ... 3.0 m = 0.1 m > 3.0 m = 0.5 m	

Technical data	Technical data	
	Power, plastic, 24 V	Power, metal, 24 V
Housing material	Zinc die-cast/PBT	PA-GF/PBT
Outer sheath, material	PVC	PVC
Conductor cross section [mm ²]	1.5	1.5
External cable diameter [mm]	10	10
Degree of protection	IP65/IP67	IP65/IP67
Ambient temperature		
Fixed installation [°C]	-40 ... 70	-40 ... 70
Flexible installation [°C]	-5 ... 70	-5 ... 70
Plug/socket [°C]	-40 ... 70	-40 ... 70

Data connectors and cables

Network components - version 14 connectors

Push-pull ADVANCE connector, IP65/67

- Available for POF, PCF, and GOF
- Easy handling, thanks to one-piece design
- Locking system to prevent unintentional removal



SC-RJ connector, straight cable outlet



SC-RJ connector, cable outlet at the top

Degree of protection	IP65/IP67
Housing material	Zinc die-cast
External cable diameter	5.5 mm ... 10 mm
Insertion/withdrawal cycles	≥ 50
Temperature data	
Ambient temperature (operation)	-40 °C ... 70 °C

Technical data		
POF	PCF	GOF
IP65/IP67	IP65/IP67	IP65/IP67
Zinc die-cast	Zinc die-cast	Zinc die-cast
5.5 mm ... 10 mm	5.5 mm ... 10 mm	5.5 mm ... 10 mm
≥ 50	≥ 50	≥ 50
-40 °C ... 70 °C	-40 °C ... 70 °C	-40 °C ... 70 °C

Technical data		
POF	PCF	GOF
IP65/IP67	IP65/IP67	IP65/IP67
Zinc die-cast	Zinc die-cast	Zinc die-cast
5.5 mm ... 10 mm	5.5 mm ... 10 mm	5.5 mm ... 10 mm
≥ 50	≥ 50	≥ 50
-40 °C ... 70 °C	-40 °C ... 70 °C	-40 °C ... 70 °C

Description	Order No.	Pcs. / Pkt.
Push-pull ADVANCE, SC-RJ connector		
Single pack	1407896	1
Pack of 10	1408047	1

Ordering data					
Order No.	Pcs. / Pkt.	Order No.	Pcs. / Pkt.	Order No.	Pcs. / Pkt.
POF		PCF		GOF	
1407896	1	1407897	1	1407898	1
1408047	1	1408048	1	1408049	1

Ordering data					
Order No.	Pcs. / Pkt.	Order No.	Pcs. / Pkt.	Order No.	Pcs. / Pkt.
POF		PCF		GOF	
1408028	1	1408029	1	1408030	1
1408093	1	1408094	1	1408095	1

Tool set for POF assembly, for field installation of SC connectors	
TF-SCRJ-POF KONF SET	1405246
FOC-TOOL-PCF KONF SET	1411051
Tool set for PCF assembly, for field installation of SC connectors	
FOC-TOOL-GOF KONF SET	1411049
Tool set for GOF assembly, for field installation of LC and SC connectors	

Accessories			
TF-SCRJ-POF KONF SET	1405246		1
FOC-TOOL-PCF KONF SET	1411051		1
FOC-TOOL-GOF KONF SET	1411049		1

Accessories			
TF-SCRJ-POF KONF SET	1405246		1
FOC-TOOL-PCF KONF SET	1411051		1
FOC-TOOL-GOF KONF SET	1411049		1

Push-pull ADVANCE connector, IP65/67



SC-RJ connector, cable outlet at the bottom



SC-RJ connector

ERIC ®

	Technical data						Technical data					
	POF		PCF		GOF		POF		PCF			
Degree of protection	IP65/IP67		IP65/IP67		IP65/IP67		IP65/IP67		IP65/IP67			
Housing material	Zinc die-cast		Zinc die-cast		Zinc die-cast		PA-GF		PA-GF			
External cable diameter	5.5 mm ... 10 mm		5.5 mm ... 10 mm		5.5 mm ... 10 mm		6.5 mm ... 9.5 mm		6.5 mm ... 9.5 mm			
Insertion/withdrawal cycles	≥ 50		≥ 50		≥ 50		≥ 500		≥ 500			
Temperature data												
Ambient temperature (operation)	-40 °C ... 70 °C		-40 °C ... 70 °C		-40 °C ... 70 °C		-20 °C ... 70 °C		-20 °C ... 70 °C			
Description	Ordering data						Ordering data					
	Order No.	Pcs. / Pkt.	Order No.	Pcs. / Pkt.	Order No.	Pcs. / Pkt.	Order No.	Pcs. / Pkt.	Order No.	Pcs. / Pkt.	Order No.	Pcs. / Pkt.
Push-pull ADVANCE, SC-RJ connector												
Single pack	1407902	1	1407904	1	1407905	1						
Pack of 10	1408053	1	1408055	1	1408056	1						
FO connector SC-RJ, IP67, with push-pull locking, duplex, with fast connection technology												
Plastic housings							1657850	1	1657863	1		
Tool set for POF assembly, for field installation of SC connectors	Accessories						Accessories					
TF-SCRJ-POF KONF SET			1405246			1	TF-SCRJ-POF KONF SET		1405246			1
FOC-TOOL-PCF KONF SET			1411051			1	FOC-TOOL-PCF KONF SET		1411051			1
FOC-TOOL-GOF KONF SET			1411049			1						

FO connectors, panel mounting frames, and couplings



SC-RJ panel mounting side

ERC

Technical data

Material data

Housing material	Zinc die-cast	Plastic housing	PA-GF
Ferrule material	-		-
Inflammability class according to UL 94	V0		V0
Color	Silver		Black
Degree of protection	IP65/IP67		IP65/IP67
Insertion/withdrawal cycles	≥ 500		≥ 500
Temperature data			
Ambient temperature (operation)	-40 °C ... 80 °C		-40 °C ... 80 °C

Metal housing		Plastic housing	
Housing material	Zinc die-cast	Plastic housing	PA-GF
Ferrule material	-		-
Inflammability class according to UL 94	V0		V0
Color	Silver		Black
Degree of protection	IP65/IP67		IP65/IP67
Insertion/withdrawal cycles	≥ 500		≥ 500
Temperature data			
Ambient temperature (operation)	-40 °C ... 80 °C		-40 °C ... 80 °C

Ordering data

Description

SC-RJ panel mounting frame, IP67, for push-pull locking, for rectangular mounting cutout, for **AVAGO transceiver (type: AFR5978BZ)** on PCB, with seal, without mounting screws

Metal housing
Plastic housing

SC-RJ panel mounting frame, IP67, incl. SC-RJ coupling, for push-pull interlocking, for square mounting cutout, with grommet, without mounting screws

Metal housing
Plastic housing

SC-RJ panel mounting frame, IP67, incl. SC-RJ coupling, for push-pull interlocking, for round mounting cutout, with seal

Type	Order No.	Pcs. / Pkt.
VS-PPC-F1-SCRJ-MNNA-1RP	1608061	1
VS-PPC-F1-SCRJ-POBK-1RP	1657889	1
VS-PPC-F1-SCRJ-MNNA-1RF	1405374	1
VS-PPC-F1-SCRJ-POBK-1RF	1608210	1
VS-PPC-F1-SCRJ-MNNA-1C-F	1405235	1

Accessories

Protective cover
for data port

VS-PPC-C1-PC-ROBK-L	1405293	1
---------------------	---------	---

Power and data field couplings,
IP65/67



SC-RJ and power field coupling
with cable connection



SC-RJ field coupling
with cable connection

ERC

Technical data	
VS-MP-PPC/CG-PO/FO	VS-MP-PPC/CG-PO
Aluminum press-drawn section / die-cast zinc	Aluminum press-drawn section / die-cast zinc
Data/power: SCRJ/5-pos. ≥ 500 (data) // ≤ 100 (power)	Power: 5-pos. ≤ 100 (power)
-40 °C ... 70 °C	-40 °C ... 70 °C

Ordering data		
Type	Order No.	Pcs. / Pkt.
VS-MP-PPC/CG-PO/FO	1404321	1
VS-MP-PPC/CG-PO	1403681	1
VS-MP-PPC/PPC-PO	1403684	1

Accessories		
VS-PPC-C1-PC-ROBK-L	1405293	1
VS-PPC-C2-PC-ROBK-L	1405303	1
VS-CABLE-STRIP-VARIO	1657407	1

ERC

Technical data	
VS-MP-PPC/CG-FO	
Aluminum press-drawn section / die-cast zinc	
Data: SCRJ ≥ 500 (data)	
-40 °C ... 70 °C	

Ordering data		
Type	Order No.	Pcs. / Pkt.
VS-MP-PPC/CG-FO	1404319	1

Accessories		
VS-CABLE-STRIP-VARIO	1657407	1

Material data
Housing material
Connection data
Connection profile
Insertion/withdrawal cycles
Temperature data
Ambient temperature (operation)

Description
Multi-port connection , for passive PROFINET cabling to robots, including mounting foot
Multi-port power connection : push-pull power, for passive PROFINET cabling to robots, including mounting foot
Multi-port power coupling : for passive PROFINET cabling to robots, including mounting foot

Protective cover
for data port
for power port
Stripping tool , for multiple-stage repositioning of shielded conductors

Terminal outlet and coupling, IP65/67

- Easy installation, thanks to captive cover screws
- Robust design
- Including covers to protect against environmental influences
- Integrated cable management system



Terminal outlet with SC-RJ and power slots



SC-RJ field coupling

ERIC

	Technical data			Technical data		
Material data						
Housing material	Aluminum cast alloy, powder-coated			Zinc die-cast		
Connection data						
Connection profile	-			-		
Insertion/withdrawal cycles	-			≥ 500		
Temperature data						
Ambient temperature (operation)	-40 °C ... 70 °C			-40 °C ... 70 °C		
	Ordering data			Ordering data		
Description	Type	Order No.	Pcs. / Pkt.	Type	Order No.	Pcs. / Pkt.
Terminal outlet SC-RJ/Power IP65/67 push-pull , 2 slots version 14, with protective plugs, 2 cable entries	VS-TO-RO-MCBK-F1417/1413	1404346	1			
Terminal outlet SC-RJ IP65/67 push-pull , 2 slots version 14, with protective plugs, 2 cable entries	VS-TO-RO-MCBK-F1417/1417	1404320	1			
SC-RJ push-pull coupling , IP67, metal, with protective cover, color: nickel-plated				VS-PPC-J-1-SCRJ-MNBK	1405206	1

RJ45 connector, IP20



RJ45 crimp connectors

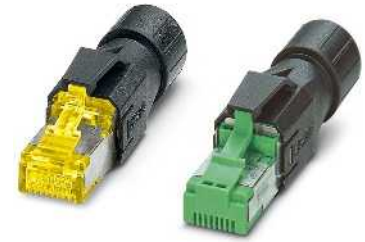

RJ45 field connection connectors

ERC

	Technical data			Technical data		
	VS-08-RJ45-10G/C	VS-08-ST-H...-RJ45		VS-08-RJ45-10G/Q	VS-...-RJ45-...-Q...	
Electrical data						
Transmission characteristics (category)	CAT6 _A	-		CAT6 _A (IEC 60512-27-100:2008, TIA-568-C.2:2009)	CAT5 (IEC 11801:2002)	
Surge voltage category	I	I		I	I	
Material data						
Housing material	-	-		PA 6.6	PA 6.6	
Contact material	Phosphor bronze	Copper alloy		CuSn	CuSn	
Inflammability class according to UL 94	V2	V2		V2	V2	
Pollution degree	-	2		2	2	
External cable diameter	-	-		4,5 mm ... 8 mm	4,5 mm ... 8 mm	
Insertion/withdrawal cycles	-	≥ 750		≥ 750	≥ 750	
Temperature data						
Ambient temperature (operation)	-25 °C ... 60 °C	-25 °C ... 60 °C		-40 °C ... 70 °C	-20 °C ... 70 °C	
	Ordering data			Ordering data		
Description	Type	Order No.	Pcs. / Pkt.	Type	Order No.	Pcs. / Pkt.
RJ45 connector , IP20, CAT6 _A , 8-pos., with QUICKON fast connection technology, for 1-wire and 7-wire AWG 26 ... 24 conductors, color: black				VS-08-RJ45-10G/Q	1419001	1
RJ45 connector , IP20, CAT5, 8-pos., with QUICKON fast connection technology, for 1 and 7-wire conductors 26 ... 24 AWG Gray Black				VS-08-RJ45-5-Q/IP20	1656725	1
RJ45 connector , 4-pos., with QUICKON fast connection technology, for 22 AWG, color: gray				VS-08-RJ45-5-Q/IP20 BK	1658008	1
RJ45 pin insert , CAT6 _A , 10 Gbps	VS-08-RJ45-10G/C	1418853	5	VS-PN-RJ45-5-Q/IP20	1658435	1
RJ45 pin insert , 8-pos., shielded, IDC connection technology, for 27 ... 26 AWG litz wires, with strain relief						
CAT5	VS-08-ST-H11-RJ45	1652716	5			
RJ45 bend protection sleeve , for VS-08-ST-H11-RJ45 and VS-08-RJ45-10G/C pin inserts, for cable diameters up to 7 mm						
Gray	VS-08-KS-H/GY	1654743	5			
Green	VS-08-KS-H/GN	1654756	5			
	Accessories			Accessories		
Crimp tool , pliers with die, for VS-08-ST-H...-RJ45	VS-CT-RJ45-H	1653265	1			
Stripping tool , for multiple-stage repositioning of shielded conductors	VS-CABLE-STRIP-VARIO	1657407	1	VS-CABLE-STRIP-VARIO	1657407	1
Shielding foil set , 25 pcs., replacement for VS-PN-RJ45-5-Q/IP20				VS-08-RJ45-FOLIEN-SET	1417184	1

RJ45 industrial connector, IP20

- Optimized for industrial use with a high degree of resistance to vibration
- High resistance to ESD and EMI for reliable transmission
- Easy handling, thanks to one-piece design
- Metal locking mechanism



RJ45 industrial, straight cable outlet



RJ45 industrial, cable outlet at the bottom and top

Degree of protection	IP20
Connection cross section AWG	26 ... 24 (solid)
Connection cross section AWG	26 ... 24 (stranded)
Transmission speed	10 Gbps
Housing material	Zinc die-cast
External cable diameter	5 mm ... 9 mm
Insertion/withdrawal cycles	≥ 750
Temperature data	
Ambient temperature (operation)	-40 °C ... 70 °C

Technical data	
Ethernet	PROFINET
IP20	IP20
26 ... 24 (solid)	23 ... 22 (solid)
26 ... 24 (stranded)	23 ... 22 (stranded)
10 Gbps	10 Gbps
Zinc die-cast	Zinc die-cast
5 mm ... 9 mm	5 mm ... 9 mm
≥ 750	≥ 750
-40 °C ... 70 °C	-40 °C ... 70 °C

Technical data	
Ethernet	PROFINET
IP20	IP20
26 ... 24 (solid)	23 ... 22 (solid)
26 ... 24 (stranded)	23 ... 22 (stranded)
10 Gbps	10 Gbps
Zinc die-cast	Zinc die-cast
5 mm ... 9 mm	5 mm ... 9 mm
≥ 750	≥ 750
-40 °C ... 70 °C	-40 °C ... 70 °C

Description
RJ45 industrial connector, 8-pos.
Single pack
Pack of 30
RJ45 industrial connector, 8-pos., cable outlet at the bottom
Single pack
Pack of 30
RJ45 industrial connector, 8-pos., cable outlet at the top
Single pack
Pack of 30

Ordering data			
Order No.	Pcs. / Pkt.	Order No.	Pcs. / Pkt.
Ethernet		PROFINET	
1406333	1	1406334	1
1406351	1	1406352	1

Ordering data			
Order No.	Pcs. / Pkt.	Order No.	Pcs. / Pkt.
Ethernet		PROFINET	
1406339	1	1406340	1
1406357	1	1406358	1
1406336	1	1406337	1
1406354	1	1406355	1

Stripping tool , for multiple-stage repositioning of shielded conductors
Electronic diagonal cutter , tapered head, without chamfer, with opening spring, non-reflective phosphate-treated surface, punched version
Markers for terminal blocks, roll , unmarked, can be marked with: THERMOMARK ROLL, THERMOMARK X, THERMOMARK S1.1
White
Red
Green
Marker for terminal blocks, sheet , white, unmarked, can be marked with: BLUEMARK CLED, BLUEMARK LED, plotter

Accessories		
VS-CABLE-STRIP-VARIO	1657407	1
MICROFOX-SP-1	1212487	1
TMT 5 R	0816430	1
TMT 5 R RD	0816427	1
TMT 5 R GN	0816401	1
UC-TMF 5	0818153	10

Accessories		
VS-CABLE-STRIP-VARIO	1657407	1
MICROFOX-SP-1	1212487	1
TMT 5 R	0816430	1
TMT 5 R RD	0816427	1
TMT 5 R GN	0816401	1
UC-TMF 5	0818153	10

RJ45 panel mounting frames and inserts, IP20



Keystone panel mounting frames and keystones

Technical data

Electrical data	VS-08-BU-RJ45-6/KA/LSA
Rated current	2 A
Transmission characteristics (category)	-
Material data	
Housing material	Nickel-plated brass
Contact material	Copper alloy
Inflammability class according to UL 94	V0
Mechanical data	
No. of pos.	8
Connection method	LSA
Conductor cross section	0.13 mm ² ... 0.32 mm ² (solid)
Connection cross section AWG	26 ... 22 (solid)
Temperature data	
Ambient temperature (operation)	-20 °C ... 70 °C

Ordering data

Description	Type	Order No.	Pcs. / Pkt.
RJ45 socket insert , 8-pos., shielded, socket to socket			
CAT5	VS-08-BU-RJ45/BU	1689064	5
RJ45 socket insert , 8-pos., shielded, with cable connection			
CAT6	VS-08-BU-RJ45-6/KA/LSA	1653168	5
RJ45 panel mounting frame , single, for modular socket inserts (keystone), without mounting screws			
	VS-08-A-RJ45/MOD-1-IP20	1689433	5

Accessories

Split-core tool , for connecting the copper wires to the LSA Plus strips	CT-WZ/A	2765505	1
Stripping tool , for multiple-stage repositioning of shielded conductors	VS-CABLE-STRIP-VARIO	1657407	1

**RJ45 patch panel
IP20**



**Patch panel
with various connection types**

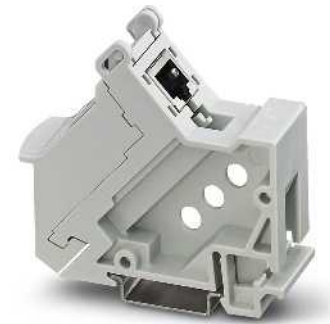

**Patch panel
with IDC fast connection**



Technical data	
FL-PP-RJ45-...	
Electrical data	
Rated voltage	-
Rated current	-
Transmission characteristics (category)	-
Material data	
Housing material	PVC / PA
Contact material	-
Inflammability class according to UL 94	-
Mechanical data	
No. of pos.	-
Color	Green
Degree of protection	IP20
Connection method	-
Conductor cross section	-
Connection cross section AWG	-
Temperature data	
Ambient temperature (operation)	-25 °C ... 70 °C

Technical data	
VS-PP-F-RJ45-CAT6	
Electrical data	
Rated voltage	50 V
Rated current	1 A
Transmission characteristics (category)	-
Material data	
Housing material	PC-GF
Contact material	Copper alloy
Inflammability class according to UL 94	V0
Mechanical data	
No. of pos.	8
Color	Gray
Degree of protection	IP20
Connection method	IDC fast connection
Conductor cross section	0.2 mm ² ... 0.32 mm ²
Connection cross section AWG	24 ... 22
Temperature data	
Ambient temperature (operation)	-10 °C ... 60 °C

Ordering data			
Type	Order No.	Pcs. / Pkt.	
Patch panel, one RJ45 socket to 8 IDC connection terminal blocks (1:1 assignment), CAT5, 10/100/1000 Mbps, DIN rail mounting, IP20, option of shield contacting on DIN rail via jumpers			
- RJ45 to LSA connection terminal blocks			
Patch panel, one RJ45 socket to 8 screw connection terminal blocks (1:1 assignment), CAT5, 10/100/1000 Mbps, DIN rail mounting, IP20, option of shield contacting on DIN rail via jumpers			
- RJ45 to screw connection terminal blocks			
Patch panel, two RJ45 sockets (1:1 assignment), CAT5, 10/100/1000 Mbps, DIN rail mounting, IP20, option of shield contacting on DIN rail via jumpers			
- RJ45 to spring connection terminal blocks			
RJ45 patch panel , DIN rail mounting, IP20, CAT6			
for 1 Gbps			
RJ45 patch panel , DIN rail mounting, IP20, CAT6 _A			
for 10 Gbps			
FL-PP-RJ45-LSA	2901645	1	
FL-PP-RJ45-SC	2901643	1	
FL-PP-RJ45/RJ45	2901646	1	
FL-PP-RJ45-SCC	2901642	1	

Ordering data			
Type	Order No.	Pcs. / Pkt.	
VS-PP-F-RJ45-CAT6	1658118	1	
VS-PP-F-RJ45-10G	1403154	1	

FO connectors, IP20



POF, 980/1000 μm



PCF, 200/230 μm, 2.9 mm

ERC

Technical data

Material data
Housing material
Ferrule material
Inflammability class according to UL 94
Color
Degree of protection
Insertion/withdrawal cycles
Temperature data
Ambient temperature (operation)

PBT
Copper alloy
V0
Black
IP20
≥ 1000

-20 °C ... 70 °C

Ordering data

Description
FO connector SC-RJ, duplex, with fast connection
IP20, for single wire diameter: 2.9 mm
IP20, for single wire diameter: 2.2 mm
FO connector for 200/230 μm PCF fibers, crimp connection
- SC-RJ
- SC duplex
Connector set for polymer fibers (diameter of the individual elements: 2.2 mm), for self-assembly, with bend protection
- F-SMA set, 4 connectors
Connector set for PCF fibers (diameter of the individual elements: 2.9 mm), for self-assembly, with bend protection
- F-SMA set, 4 connectors
- B-FOC (ST®) set, 4 connectors
Connector set for PROFINET PCF fibers (diameter of the individual elements: 2.2 mm), for self-assembly, with bend protection
- SC duplex set, 2 duplex connectors
- B-FOC (ST®) set, 4 connectors

Type	Order No.	Pcs. / Pkt.
VS-SCRJ-POF-FA-IP20	1654879	1
PSM-SET-FSMA/4-KT	2799720	1

Accessories

Tool set for POF assembly , for field installation of SC connectors
Tool set for PCF assembly , for field installation of SC connectors

TF-SCRJ-POF KONF SET	1405246	1
----------------------	---------	---

ERC

Technical data

PBT
Copper alloy
V0
Black
IP20
≥ 1000

-20 °C ... 70 °C

Ordering data

Type	Order No.	Pcs. / Pkt.
VS-SCRJ-HCS-FA-IP20	1654866	1
PSM-SET-FSMA/4-HCS	2799487	1
PSM-SET-B-FOC/4-HCS	2708481	1

Accessories

--	--	--



PCF, 200/230 μm, 2.2 mm



PCF, 200/230 μm

ERIC

Technical data			Technical data		
PBT Copper alloy V0 Black IP20 ≥ 1000			PBT Zirconia ceramics V0 Beige IP20 ≥ 500		
-20 °C ... 70 °C			-40 °C ... 70 °C		
Ordering data			Ordering data		
Type	Order No.	Pcs. / Pkt.	Type	Order No.	Pcs. / Pkt.
VS-SCRJ-HCS-FA-IP20-PN	1404087	1	FOC-C-SCRJ-PCF	1411304	1
			FOC-C-SCDU-PCF	1411305	1
PSM-SET-SC-DUPLEX/2-HCS/PN	2313779	1			
PSM-SET-B-FOC/4-HCS/PN	2313782	1			
Accessories			Accessories		
			FOC-TOOL-PCF KONF SET	1411051	1

Network components - IP20 connectors

FO connector, IP20, field connection

- Cleave technology
- Reusable connectors
- Optimum attenuation values with easy assembly
- No bonding or polishing



LC duplex connector,
1.25 mm - ferrules



LC simplex connector for pigtails,
1.25 mm - ferrules

	Technical data			Technical data		
Material data						
Housing material	-			-		
Ferrule material	Zirconia ceramics			Zirconia ceramics		
Inflammability class according to UL 94	V0			V0		
Color	Beige			Beige		
Degree of protection	IP20			IP20		
Insertion/withdrawal cycles	≥ 500 (according to IEC 61300-2-2)			≥ 500 (according to IEC 61300-2-2)		
Temperature data						
Ambient temperature (operation)	-10 °C ... 70 °C (IEC 61300-2)			-10 °C ... 70 °C (IEC 61300-2)		
	Ordering data			Ordering data		
Description	Type	Order No.	Pcs. / Pkt.	Type	Order No.	Pcs. / Pkt.
FO connector, fast connection, reusable						
GOF, 50/125 µm, multi mode	FOC-C-LCDU-GOF-MM	1411052	1	FOC-C-LC-P-GOF-MM	1411294	1
GOF, 9/125 µm, single mode (APC)	FOC-C-LCDU-GOF-SM-APC	1412472	1	FOC-C-LC-P-GOF-SM-APC	1412476	1
GOF, 9/125 µm, single mode (PC)	FOC-C-LCDU-GOF-SM-PC	1411053	1	FOC-C-LC-P-GOF-SM-PC	1411295	1
FO connector, fast connection, reusable, value pack						
GOF, 50/125 µm, multi mode	FOC-C-LCDU-GOF-MM/10	1411298	1			
GOF, 9/125 µm, single mode (APC)	FOC-C-LCDU-GOF-SM-APC/10	1412479	1			
GOF, 9/125 µm, single mode (PC)	FOC-C-LCDU-GOF-SM-PC/10	1411299	1			
	Accessories			Accessories		
Tool set for GOF assembly, for field installation of LC and SC connectors	FOC-TOOL-GOF KONF SET	1411049	1	FOC-TOOL-GOF KONF SET	1411049	1

new



SC duplex connector,
2.5 mm - ferrules

new



SC simplex connector for pigtails,
2.5 mm - ferrules

new



SC-RJ connector,
2.5 mm - ferrules

Technical data
-
Zirconia ceramics
V0
Green
IP20
≥ 500 (according to IEC 61300-2-2)
-10 °C ... 70 °C (IEC 61300-2)

Technical data
-
Zirconia ceramics
V0
Blue
IP20
≥ 500 (according to IEC 61300-2-2)
-10 °C ... 70 °C (IEC 61300-2)

Technical data
-
Zirconia ceramics
V0
Beige
IP20
≥ 500 (according to IEC 61300-2-2)
-10 °C ... 70 °C (IEC 61300-2)

Ordering data		
Type	Order No.	Pcs. / Pkt.
FOC-C-SCDU-GOF-MM	1411292	1
FOC-C-SCDU-GOF-SM-APC	1412474	1
FOC-C-SCDU-GOF-SM-PC	1411293	1
FOC-C-SCDU-GOF-MM/10	1411302	1
FOC-C-SCDU-GOF-SM-APC/10	1412481	1
FOC-C-SCDU-GOF-SM-PC/10	1411303	1

Ordering data		
Type	Order No.	Pcs. / Pkt.
FOC-C-SC:P-GOF-MM	1411296	1
FOC-C-SC:P-GOF-SM-APC	1412478	1
FOC-C-SC:P-GOF-SM-PC	1411297	1

Ordering data		
Type	Order No.	Pcs. / Pkt.
FOC-C-SCRJ-GOF-MM	1411290	1
FOC-C-SCRJ-GOF-SM-APC	1412473	1
FOC-C-SCRJ-GOF-SM-PC	1411291	1
FOC-C-SCRJ-GOF-MM/10	1411300	1
FOC-C-SCRJ-GOF-SM-APC/10	1412480	1
FOC-C-SCRJ-GOF-SM-PC/10	1411301	1

Accessories		
FOC-TOOL-GOF KONF SET	1411049	1

Accessories		
FOC-TOOL-GOF KONF SET	1411049	1

Accessories		
FOC-TOOL-GOF KONF SET	1411049	1

Fiber optic couplings

Suitable for fiber types:

- POF (980/1000 μm), PCF (200/230 μm), GOF MM (50/125 μm), GOF SM (9/125 μm)



SC-RJ coupling



Couplings for connecting FO cables

	Technical data			Technical data		
Material data						
Housing material	PBT			-		
Ferrule material	Zirconia ceramics			-		
Inflammability class according to UL 94	V0			-		
Color	Black			-		
Degree of protection	IP20			-		
Insertion/withdrawal cycles	≥ 500			-		
Temperature data						
Ambient temperature (operation)	-25 °C ... 70 °C			-		
	Ordering data			Ordering data		
Description	Type	Order No.	Pcs. / Pkt.	Type	Order No.	Pcs. / Pkt.
SC-RJ coupling, for VS-TO-... terminal outlets and 19" VS-PP-19-1HE-16-F patch panels, and VS-SI-FP-2F front plate	VS-SCRJ-GOF-KU	1654358	1			
Coupling; set, consisting of:				PSM-SET-FSMA-LINK/2	2799416	1
- 2x F-SMA/F-SMA				PSM-SET-BFOC-LINK/2	2799429	1
- 2x B-FOC (ST®)/B-FOC (ST®)				VS-SCRJ-GOF-BU/BU	1652978	1
- 1 x SC-RJ/SC-RJ (duplex)				FL MM PATCH COUPLER LC-LC	2700312	1
- 1 x LC/LC (duplex, multi-mode fiber)				FL SM PATCH COUPLER LC-LC	2700313	1
- 1 x LC/LC (duplex, single-mode fiber)				FL COUPLER SC-DUPLEX	2901788	1
- 1x SC duplex/SC duplex						

FO patch panel and splice box

- Patch panel suitable for fiber types:
- POF (980/1000 μm), PCF (200/230 μm), GOF MM (50/125 μm), GOF SM (9/125 μm)
- Splice box:
- Compact dimensions despite large splice comb
 - Snap-in adapter for easy DIN rail mounting
 - Ready for equipotential bonding
 - Suitable for industrial applications



SC-RJ patch panel, socket/socket



Splice box for DIN rail

	Technical data			Technical data		
Material data						
Housing material	PC-GF			Sheet steel		
Ferrule material	Zirconia ceramics			-		
Inflammability class according to UL 94	V0			V0		
Color	Gray			Light gray RAL 7035		
Degree of protection	IP20			IP20		
Insertion/withdrawal cycles	≥ 500			> 500		
Temperature data						
Ambient temperature (operation)	-10 °C ... 60 °C			-25 °C ... 70 °C (according to IEC 61300-2)		
	Ordering data			Ordering data		
Description	Type	Order No.	Pcs. / Pkt.	Type	Order No.	Pcs. / Pkt.
SC-RJ patch panel , DIN rail mounting, IP20, 1 slot	VS-PP-F-SCRJ	1658121	1	FOC-PP-SB-LC:6	1411901	1
Splice box , for DIN rail, robust metal housing, for GOF multi mode				FOC-PP-SB-SC:6	1411902	1
6 x LC duplex				FOC-PP-SB-ST:6	1411903	1
6 x SC duplex						
12 x ST						
	Accessories			Accessories		
Cable gland , M20				G-INS-M20-S68N-PNES-GY	1411125	5
Locking nut, M20				A-INL-M20-P-GY	1411207	5

Data connectors and cables

Network components - accessories

Accessories for processing fiber optics



Description	Ordering data			Description	Ordering data		
	Type	Order No.	Pcs. / Pkt.		Type	Order No.	Pcs. / Pkt.
Ceramic blade	FOC-TOOL-CERAMIC-BLADE	1407019	1				
Solvent dispenser, 100 ml, lockable pump dispenser				FOC-TOOL-DISPENSER	1406995	1	

Polishing fiber optic connectors



Description	Ordering data			Description	Ordering data		
	Type	Order No.	Pcs. / Pkt.		Type	Order No.	Pcs. / Pkt.
Polishing film, silicon carbide 15 µm	FOC-POLISHINGFILM-SK-15.0	1407034	25				
Polishing film, AlO₂ 1 µm	FOC-POLISHINGFILM-AO-01.0	1407037	25				
3 µm	FOC-POLISHINGFILM-AO-03.0	1407039	25				
Polishing film, diamond 0.1 µm	FOC-POLISHINGFILM-D-00.1	1407046	10				
1 µm	FOC-POLISHINGFILM-D-01.0	1407042	10				
9 µm	FOC-POLISHINGFILM-D-09.0	1407044	10				
Polishing disc 1.25 mm, for LC				FOC-POLISHINGDISC-1.25	1407024	1	
2.50 mm, for ST, SC, FC				FOC-POLISHINGDISC-2.50	1407021	1	

Cleaning tools for fiber optic connection technology



Description	Ordering data			Ordering data		
	Type	Order No.	Pcs. / Pkt.	Type	Order No.	Pcs. / Pkt.
Ferrule cleaner , approx. 500 cleaning cycles						
1.25 mm, for LC	FOC-TOOL-FERRULECLEANER-1.25	1407032	1			
2.50 mm, for ST, SC, FC	FOC-TOOL-FERRULECLEANER-2.50	1407029	1			
Stick cleaner for couplings and plug end faces						
1.25 mm, for LC				FOC-TOOL-STICKCLEANER-1.25	1407000	1
2.50 mm, for ST, SC, FC				FOC-TOOL-STICKCLEANER-2.50	1407002	1

Tool for processing fiber optics



Description	Ordering data			Ordering data		
	Type	Order No.	Pcs. / Pkt.	Type	Order No.	Pcs. / Pkt.
Fiber stripper , for stripping the coating from 250 µm to 125 µm						
For 1 fiber	FOC-TOOL-STRIPPING-1HOLE-250	1407004	1			
For 2 fibers	FOC-TOOL-STRIPPING-2HOLE-250	1407008	1			
T-stripper						
AWG 18 ... 10/1.0 mm ... 2.6 mm				FOC-TOOL-STRIPPING-T-1	1407016	1
AWG 30 ... 22/0.25 mm ... 0.64 mm				FOC-TOOL-STRIPPING-T-2	1407014	1
Electrician's scissors , high cutting performance, thanks to micro-serrated cutting area, suitable for copper, aluminum, Kevlar fibers, and plastic, two-component non-slip soft-grip handles, ergonomic design, adjustable screw joint				CUTFOX-ES	1212621	1

Data connectors and cables

Network components - accessories

Tools for FO cabling, POF

- For quick and easy field assembly
- No bonding or polishing
- Blade can be replaced easily on site
- Optimum attenuation values with easy assembly
- Reusable connectors



Description	Ordering data			Ordering data		
	Type	Order No.	Pcs. / Pkt.	Type	Order No.	Pcs. / Pkt.
Polishing tool set SC-RJ, for polymer fiber , for field assembly of SC-RJ/IP20 and SC-RJ/IP67 connectors with fast connection system	VS-SCRJ-POF-KONFTOOL-POLISH	1658820	1			
Refill set for VS-SC-RJ-POF-KONFTOOL-POLISH , consisting of two polishers and a polishing disc - For SCRJ connectors	VS-SCRJ-POF-POLISH	1656673	1			
Tool set for POF assembly , for field installation of SC connectors.				TF-SCRJ-POF KONF SET	1405246	1
Cutting tool , SC-RJ, for polymer fiber				CUTFOX-SCRJ-POF	1405247	1
Sheath stripping tool , for polymer fiber				WIREFOX-PN POF	1405249	1
Electrician's scissors , high cutting performance, thanks to micro-serrated cutting area, suitable for copper, aluminum, Kevlar fibers, and plastic, two-component non-slip soft-grip handles, ergonomic design, adjustable screw joint				CUTFOX-ES	1212621	1

**Tools for FO cabling,
PCF**

- Cleave technology
- For quick and easy field assembly
- No bonding or polishing
- A real alternative to splicing
- Optimum attenuation values with easy assembly



Ordering data			
Description	Type	Order No.	Pcs. / Pkt.
Tool set for PCF assembly, for field installation of SC connectors	FOC-TOOL-PCF KONF SET	1411051	1

**Tools for FO cabling,
GOF**

- Cleave technology
- For quick and easy field assembly
- No bonding or polishing
- A real alternative to splicing
- Optimum attenuation values with easy assembly
- Reusable connectors



Ordering data			
Description	Type	Order No.	Pcs. / Pkt.
Tool set for GOF assembly, for field installation of LC and SC connectors	FOC-TOOL-GOF KONF SET	1411049	1

Ethernet RJ45, patch cables



Ethernet

RJ45 connector, IP20, straight



RJ45 connector, IP20, angled



RJ45 connector, IP20, straight



RJ45 connector, IP20, angled



Ordering data

Order No.

0.3 m	1417993
0.5 m	1418028
1 m	1418057
2 m	1418109
5 m	1418141

Ordering data

Order No.

0.3 m	1418002
0.5 m	1418031
1 m	1418070
2 m	1418125
5 m	1418154

0.3 m	1418015
0.5 m	1418044
1 m	1418099
2 m	1418138
5 m	1418167

Notes:

For information about the cable qualities, see page 445

Pin	RJ45 ^{*)}	Wire color	Signal
1	1	WHOG	D1+
2	2	OG	D1-
5	5	WHBU	D3+
4	4	BU	D3-
3	3	WHGN	D2+
6	6	GN	D2-
7	7	WHBN	D4+
8	8	BN	D4-

*) RJ45 assignment according to TIA568B

Transmission characteristics (category)

Cable structure
Conductor cross section
Conductor structure for signal
AWG signal line
Cable diameter
Conductor resistance
Type of shield

Conductor material
Outer sheath material
Color of outer sheath
Color, single wire

Ambient temperature

Fixed installation	[°C]	-40 ... 80
Flexible installation	[°C]	-20 ... 80

Technical data

Patch cable

CAT5
4x2xAWG26/7; SF/UTP
4x 2x 0.14 mm²
7x 0.16 mm
26
6.4 mm
≤ 290 Ω/km
Aluminum-coated foil, tinned copper braided shield

Bare Cu litz wires
PUR
water blue RAL 5021
white/blue-blue,
white/orange-orange,
white/green-green,
white/brown-brown

RJ45 patch cables

Notes:

Additional accessories for network installation can be found in the "Ethernet networks" section on page 376

Ethernet



RJ45 patch cables
for IP20 applications

Technical data

	FL CAT5 PATCH 0,3	FL CAT6 PATCH 0,3
Cable, properties		
External diameter	5.5 mm	5.5 mm
Single wire, material	Cu litz wire	Cu litz wire
Individual wires per module	8	8
Single wire, cross section	0.14 mm ²	0.14 mm ²
Outer sheath, material	LSFROH	LSFROH
Smallest bending radius, fixed installation	30 mm	30 mm
Shielding	SF/UTP	S/FTP
Plug		
Contact resistance	≤ 0.003 Ω (IEC 60603-7)	≤ 0.003 Ω (IEC 60603-7)
General data		
Ambient temperature (operation)	-10 °C ... 60 °C	-10 °C ... 60 °C

Ordering data

Description	Length of cable	Type	Order No.	Pcs. / Pkt.
Patch cable, CAT5, preassembled	0.3 m	FL CAT5 PATCH 0,3	2832250	10
	0.5 m	FL CAT5 PATCH 0,5	2832263	10
	1 m	FL CAT5 PATCH 1,0	2832276	10
	1.5 m	FL CAT5 PATCH 1,5	2832221	10
	2 m	FL CAT5 PATCH 2,0	2832289	10
	3 m	FL CAT5 PATCH 3,0	2832292	10
	5 m	FL CAT5 PATCH 5,0	2832580	10
	7.5 m	FL CAT5 PATCH 7,5	2832616	10
	10 m	FL CAT5 PATCH 10,0	2832629	10
	Patch cable, CAT6, preassembled	0.3 m	FL CAT6 PATCH 0,3	2891181
0.5 m		FL CAT6 PATCH 0,5	2891288	10
1 m		FL CAT6 PATCH 1,0	2891385	10
1.5 m		FL CAT6 PATCH 1,5	2891482	10
2 m		FL CAT6 PATCH 2,0	2891589	10
3 m		FL CAT6 PATCH 3,0	2891686	10
5 m		FL CAT6 PATCH 5,0	2891783	10
7.5 m		FL CAT6 PATCH 7,5	2891880	10
10 m		FL CAT6 PATCH 10	2891877	10
12.5 m		FL CAT6 PATCH 12,5	2891369	5
15 m		FL CAT6 PATCH 15,0	2891372	5
20 m		FL CAT6 PATCH 20,0	2891576	5

Accessories

The reliability of networks is becoming more and more important and is a decisive factor for the future of entire companies. Independent studies show that more than 70% of network errors and crashes are due to faulty cabling infrastructure and manipulation of the connecting cables.

With the new accessories for Factoryline patch cables, the various safety requirements for automation are comprehensively met.



Dust protection for SFN switches and FL MC 1000 and 2000 media converters



Security lock for SFN switches and FL MC 1000 and 2000 media converters

Description	Ordering data			Ordering data		
	Type	Order No.	Pcs. / Pkt.	Type	Order No.	Pcs. / Pkt.
Dust protection with color marking , for SFN switch and angled patch connector - Black - Blue - Brown - Yellow - Gray - Green - Red - Violet - White	FL DUST CVR BK FL DUST CVR BU FL DUST CVR BN FL DUST CVR YE FL DUST CVR GY FL DUST CVR GN FL DUST CVR RD FL DUST CVR VT FL DUST CVR WH	2891107 2891204 2891301 2891408 2891505 2891602 2891709 2891806 2891903	10 10 10 10 10 10 10 10 10			
Security frame for SFN switch and patch fields - Green - Red - White				FL PLUG GUARD GN FL PLUG GUARD RD FL PLUG GUARD WH	2891615 2891712 2891819	20 20 20
Locking element for FL PLUG GUARD... security frame - Locking element - Key				FL PORT GUARD FL PLUG GUARD KEY	2891220 2891327	20 1
Color marking for FL CAT... Patch... - Black - Blue - Brown - Yellow - Gray - Green - Red - Violet						
Security element for FL CAT ...patch... - Security element - Security element, lockable - Key						
Dust protection cap for RJ45 socket						





Color coding for RJ45 FL patch cables



Security element for RJ45 FL patch cables



Dust protection for RJ45 sockets

Ordering data		
Type	Order No.	Pcs. / Pkt.
FL PATCH CCODE BK	2891194	20
FL PATCH CCODE BU	2891291	20
FL PATCH CCODE BN	2891495	20
FL PATCH CCODE YE	2891592	20
FL PATCH CCODE GY	2891699	20
FL PATCH CCODE GN	2891796	20
FL PATCH CCODE RD	2891893	20
FL PATCH CCODE VT	2891990	20

Ordering data		
Type	Order No.	Pcs. / Pkt.
FL PATCH SAFE CLIP	2891246	20
FL PATCH GUARD	2891424	20
FL PATCH GUARD KEY	2891521	1

Ordering data		
Type	Order No.	Pcs. / Pkt.
FL RJ45 PROTECT CAP	2832991	10

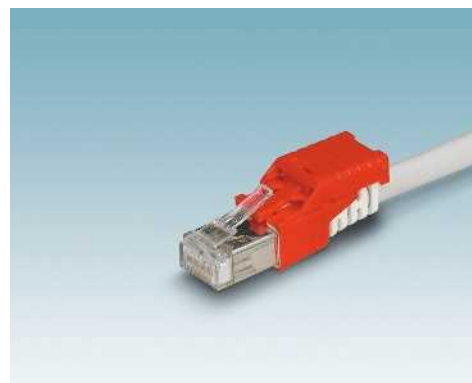

Modular distribution panel

- Plug and play
- Extremely robust design
- GHMT-certified
- Front release without special tool
- Modules can be replaced



Assembled modules
for 19" mounting frames



19" mounting frame

	Technical data			Technical data		
Electrical data	CAT6 _A			CUC-PP-FRAME-19		
Transmission characteristics (category)	Class E _A			-		
Material data	Stainless steel			Steel, powder-coated		
Housing material	V0			V0		
Inflammability class according to UL 94	-			-		
Connection data	18 mm ... 18 mm			-		
External cable diameter	≥ 750			-		
Insertion/withdrawal cycles	-			-		
Temperature data	-20 °C ... 60 °C			-20 °C ... 60 °C		
Ambient temperature (operation)						
	Ordering data			Ordering data		
Description	Type	Order No.	Pcs. / Pkt.	Type	Order No.	Pcs. / Pkt.
19-inch frame , empty, for using 8 modules (RJ45/ARJ45)				CUC-PP-FRAME-19	1407986	1
Gray (similar to RAL 7035) Black (similar to RAL 9005)				CUC-PP-FRAME-19 BK	1409140	1
RJ45 module , 6 x RJ45 to 6 x RJ45, CAT6 _A , can be unlocked from the front, variable length	CUC-PP-MODUL-RJ45:6-RJ45:6/...	1407995	1			
Patch bay , 19", for orderly cabling in the control cabinet				CUC-PP-PATCHBAY	1407994	1
Gray, with plastic hooks						
Dummy frame , size of one module, for use in the frame	CUC-PP-MODUL-COVER	1407988	1			
	Accessories			Accessories		
Screw set , fixing material for the frame				CUC-PP-FRAME-SCREWSET	1407989	1
Cable binder , fixing material for module cable routing	CUC-PP-MODUL-CABLEFIXSET	1407991	1			

Ordering example for modules of variable length:

For an RJ45 module with a cable length of 25.0 m, the ordering data is as follows:

Order No.	Length [m]
1407995	25
	Max. 80 m
	Increment: 1.5 m ... 80 m = 0.5 m

Network cables, sold by the meter, PROFINET, EtherCAT®, shielded



Notes:
For information about the cable qualities, see page 440



4-wire, star quad

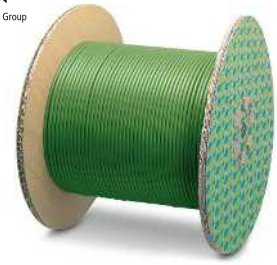

4-wire, star quad

Description	Ordering data			Ordering data		
	Type	Order No.	Pcs. / Pkt.	Type	Order No.	Pcs. / Pkt.
PVC solid - green, 1 x 4 x 22 AWG, CAT5, SF/TQ, type A						
Cable ring: 100 m	VS-OE-OE-93A-100,0	1416392	1			
Cable ring: 1 m ... 100 m	VS-93A/...	1416486	1			
PVC stranded - green, 1 x 4 x 22 AWG, CAT5, SF/TQ, type B						
Cable ring: 100 m	VS-OE-OE-93B-100,0	1416389	1			
Cable ring: 1 m ... 100 m	VS-OE-OE-93B/...	1417362	1			
Cable drum: 110 m ... 500 m	NBC-93B/...	1408537	1			
PUR suitable for use with drag chain - green, 1 x 4 x 22 AWG, CAT5, SF/TQ, type C						
Cable ring: 100 m	VS-OE-OE-93C-100,0	1416376	1			
Cable ring: 1 m ... 100 m	VS-OE-OE-93C/...	1417491	1			
Cable drum: 110 m ... 500 m	NBC-93C/...	1408538	1			
PUR suitable for use with robots - green, 1 x 4 x 22 AWG, CAT5, S/TQ						
Cable ring: 100 m	VS-OE-OE-93R-100,0	1416363	1			
Cable ring: 1 m ... 100 m	VS-OE-OE-93R/...	1417388	1			
Cable drum: 110 m ... 500 m	NBC-93R/...	1408539	1			
RADOX® for railway applications - black, 1 x 4 x 22 AWG, CAT5, SF/TQ						
Cable ring: 1 m ... 100 m	VS-OE-OE-937/...	1402687	1			
Cable drum: 110 m ... 500 m	NBC-937/...	1408540	1			
PVC stranded - green, 1 x 4 x 22 AWG, CAT5, SF/TQ						
Cable drum: 110 m ... 500 m	NBC-93G/...	1408541	1			

Ordering example for cables with variable cable length:

For a network cable type 93A with a cable length of 34.0 m, the ordering data is as follows:

Order No.	Length [m]
1416486	34.0
	Max. 100 m
	Increment:
	1.0 m ... 100 m = 1.0 m
	110 m ... 500 m = 10 m

Network cables, sold by the meter,
Ethernet, shielded

Notes:
For information about the cable qualities, see page 440

Ethernet



2-pair, twisted pair

Ethernet



4-pair, twisted pair

Description	Ordering data			Ordering data		
	Type	Order No.	Pcs. / Pkt.	Type	Order No.	Pcs. / Pkt.
PUR stranded - blue, 2 x 2 x 26 AWG, CAT5, SF/UTP						
Cable ring: 100 m	VS-OE-OE-93E-100,0	1416295	1			
Cable ring: 1 m ... 100 m	VS-OE-OE-93E/...	1417320	1			
Cable drum: 110 m ... 500 m	NBC-93E/...	1408534	1			
PUR solid - blue, 4 x 2 x 24 AWG, CAT5, SF/UTP						
Cable ring: 100 m				VS-OE-OE-94A-100,0	1416305	1
Cable ring: 1 m ... 100 m				VS-94A/...	1416415	1
PUR stranded - blue, 4 x 2 x 26 AWG, CAT5, SF/UTP						
Cable ring: 100 m				VS-OE-OE-94B-100,0	1416567	1
Cable ring: 1 m ... 100 m				VS-OE-OE-94B/...	1417333	1
Cable drum: 110 m ... 500 m				NBC-94B/...	1408535	1
PUR suitable for use with drag chain - blue, 4 x 2 x 26 AWG, CAT5, S/UTP						
Cable ring: 100 m				VS-OE-OE-94C-100,0	1416318	1
Cable ring: 1 m ... 100 m				VS-OE-OE-94C/...	1417346	1
Cable drum: 110 m ... 500 m				NBC-94C/...	1408536	1
PVC stranded, outdoor - black, 4 x 2 x 26 AWG, CAT5, SF/UTP						
Cable ring: 100 m				VS-OE-OE-94D-100,0	1416334	1
Cable ring: 1 m ... 100 m				VS-94D/...	1416444	1
FRNC solid - blue, 4 x 2 x 23 AWG, CAT7, S/FTP						
Cable ring: 100 m				VS-OE-OE-94E-100,0	1416350	1
Cable ring: 1 m ... 100 m				VS-94E/...	1416460	1
PUR stranded - blue, 4 x 2 x 26 AWG, CAT6 _A , S/FTP						
Cable ring: 100 m				VS-OE-OE-94F-100,0	1416347	1
Cable ring: 1 m ... 100 m				VS-OE-OE-94F/...	1417359	1

Ordering example for cables
with variable cable length:

For a network cable type 94A with a cable length of 34.0 m, the ordering data is as follows:

Order No.	Length [m] Max. 100 m
1416415	34.0
	Increment: 1.0 m ... 100 m = 1.0 m 110 m ... 500 m = 10 m

Data connectors and cables

Network components - assembled cables

Assembled cables,
PROFINET, 4-pos.,
shielded, CAT5



RJ45 connector, IP20

RJ45 connector, IP20

RJ45 connector,
Version 14, metal



R4AC

R4ACR

R4RC

Ordering data

Ordering data

Ordering data

Order No.

Order No.

Order No.

Open cable end



OE

RJ45 connector, IP20



R4AC

RJ45 connector, IP20



R4ACR

RJ45 connector, Version 14,
metal



R4RC

RJ45 connector, Version 14,
plastic



R4QC

M12 connector, SPEEDCON



MSD SCO

M12 connector, SPEEDCON



MRD SCO

Ordering data	Ordering data	Ordering data
Order No.	Order No.	Order No.
Variable 1411857	Variable 1411858	5 m 1416162
1 m 1408968	1 m 1418248	Variable 1411859
2 m 1408969	2 m 1418277	
5 m 1408970		5 m 1416138
10 m 1408971		Variable 1411863
Variable 1411861	Variable 1411862	
	1 m 1409002	
	2 m 1409003	
	5 m 1409004	
	10 m 1409005	
	Variable 1411865	
		1 m 1408974
		2 m 1408975
		5 m 1408972
		10 m 1408976
		Variable 1411866

Information for products with fixed cable length:

Products with fixed cable length are produced with the 93B cable type and are available from stock.

Ordering data for cables with variable cable length:

For a network cable, type 93C, fitted with a straight M12 connector at one end and an RJ45 connector with IP20 protection at the other end, and 4.5 m in length, the ordering data is as follows:

Cable description	Cable type	Pin		Wire color	Signal
		M12	RJ45		
PVC stranded - green, 1 x 4, CAT5	93B	1	1	YE	TD+
PUR suitable for drag chain applications - green, 1 x 4, CAT5	93C	3	2	OG	TD-
PUR for robot applications - green, 1 x 4, CAT5	93R	2	3	WH	RD+
RADOX® for railway applications - black, 1 x 4, CAT5	937	4	6	BU	RD-
PUR stranded - green, 1 x 4, CAT5	93M				

Order No.	Cable type	Length [m] Max. 100 m
1408639	93C	4.5
Minimum order amount = 25		
Increments: 0.2 ... 3 m = 0.1 m > 3 m = 0.5 m		

RJ45 connector, Version 14, plastic	M12 connector, SPEEDCON	M12 connector, SPEEDCON	M12 socket, SPEEDCON	M12 socket, SPEEDCON	M12 flush-type socket, rear mounting
					
R4QC	MSD SCO	MRD SCO	FSD SCO	FRD SCO	FSDBP
Ordering data		Ordering data		Ordering data	
Order No.	Order No.	Order No.	Order No.	Order No.	Order No.
	1 m 1407495		1 m 1407528		1 m 1437779
	2 m 1407496		2 m 1407529		2 m 1437782
5 m 1416168	5 m 1407497		5 m 1407530		5 m 1437795
	10 m 1407498		10 m 1407531		
Variable 1411860	Variable 1408640	Variable 1408633	Variable 1408623	Variable 1408615	
	1 m 1407499		1 m 1407532		
	2 m 1407500		2 m 1407533		
5 m 1416141	5 m 1407501		5 m 1407534		
	10 m 1407502		10 m 1407535		
Variable 1411864	Variable 1408639	Variable 1408632	Variable 1408622	Variable 1408613	
	1 m 1407508		1 m 1407536		
	2 m 1407509		2 m 1407537		
	5 m 1407510		5 m 1407538		
	10 m 1407511		10 m 1407539		
	Variable 1408638	Variable 1408631	Variable 1408621	Variable 1408612	
	1 m 1407516		1 m 1407544		
	2 m 1407517		2 m 1407545		
	5 m 1407518		5 m 1407546		
	10 m 1407519		10 m 1407547		
	Variable 1408636	Variable 1408628	Variable 1408619	Variable 1408610	
1 m 1408978	1 m 1407520		1 m 1407548		
2 m 1408979	2 m 1407521		2 m 1407549		
5 m 1408977	5 m 1407522		5 m 1407551		
10 m 1408980	10 m 1407523		10 m 1407552		
Variable 1411867	Variable 1408635	Variable 1408626	Variable 1408618	Variable 1408609	
	1 m 1407524		1 m 1407553		
	2 m 1407525		2 m 1407554		
	5 m 1407526		5 m 1407555		
	10 m 1407527		10 m 1407556		
	Variable 1408634	Variable 1408625	Variable 1408617	Variable 1408608	
		Variable 1408624	Variable 1408616	Variable 1408607	

	Technical data	Technical data	Technical data	Technical data
	PROFINET PVC stranded CAT5 [93B]	PROFINET drag chain CAT5 [93C]	PROFINET robot CAT5 [93R]	PROFINET railway applications [937]
Transmission characteristics (category)	CAT5	CAT5	CAT5	CAT5
Cable structure	1x4xAWG22/7; SF/TQ	1x4xAWG22/7; SF/TQ	1x4xAWG22/19; S/TQ	1x4xAWG22/7; SF/TQ
Conductor cross section	4x 0.34 mm ²	4x 0.34 mm ²	4x 0.34 mm ²	4x 0.34 mm ²
Conductor structure for signal	7x 0.25 mm	7x 0.25 mm	19x 0.15 mm	7x 0.25 mm
AWG signal line	22	22	22	22
Cable diameter	6.5 mm	6.5 mm	6.5 mm	6.6 mm
Conductor resistance	≤ 120 Ω/km	≤ 120 Ω/km	≤ 120 Ω/km	≤ 54.4 Ω/km
Type of shield	Aluminum-coated foil, tinned copper braided shield	Aluminum-coated foil, tinned copper braided shield	Tinned copper braided shield	Plastic-coated aluminum foil, tinned copper braided shield
Conductor material	Tin-plated Cu litz wires	Tin-plated Cu litz wires	Tin-plated Cu litz wires	Silver-plated Cu litz wires
Outer sheath material	PVC	PUR	PUR	RADOX® GKW S
Color of outer sheath	Green RAL 6018	Green RAL 6018	Green RAL 6018	Black RAL 9005
Color, single wire	White, yellow, blue, orange	White, yellow, blue, orange	White, yellow, blue, orange	white-blue, orange-yellow
Ambient temperature				
Fixed installation	[°C] -40 ... 70	[°C] -40 ... 70	[°C] -40 ... 80	[°C] -50 ... 90
Flexible installation	[°C] -40 ... 70	[°C] -40 ... 70	[°C] -40 ... 80	[°C] -40 ... 90

Data connectors and cables

Network components - assembled cables

Assembled cables, EtherCAT®, 4-pos., shielded, CAT5



RJ45 connector, IP20



R4AC

Ordering data

Order No.

RJ45 connector, IP20



R4ACR

Ordering data

Order No.

M12 connector, SPEEDCON



MSD SCO

Ordering data

Order No.

Open cable end



OE

RJ45 connector, IP20



R4AC

RJ45 connector, IP20



R4ACR

M12 connector, SPEEDCON



MSD SCO

M12 connector, SPEEDCON



MRD SCO

RJ45 connector, Freetnet



F4AC

	Order No.	Order No.	Order No.
Variable	1411868	Variable	1411869
1 m	1408981	1 m	1402505
2 m	1408982	2 m	1402508
5 m	1408983		
10 m	1408984	Variable	1411871
		1 m	1409006
		2 m	1409007
		5 m	1409014
		10 m	1409015
		Variable	1411872
		1 m	1407565
		2 m	1407566
		5 m	1407567
		10 m	1407568
		Variable	1408598
		1 m	1407569
		2 m	1407570
		5 m	1407571
		10 m	1407572
		Variable	1408597
2 m	1419142		
Variable	1411873		

Information for products with fixed cable length:





Products with fixed cable length are produced with the 93G cable type and are available from stock.

Cable description	Cable type	Pin		Wire color	Signal
		M12	RJ45		
PVC stranded - green, 1 x 4, CAT5	93G	1	1	YE	TD+
		3	2	OG	TD-
PUR suitable for drag chain applications - green, 1 x 4, CAT5	93H	2	3	WH	RD+
		4	6	BU	RD-

Ordering data for cables with variable cable length:

For a network cable, type 93H, fitted with a straight M12 connector at one end and an RJ45 connector with IP20 protection at the other end, and 4.5 m in length, the ordering data is as follows:

Order No.	Cable type	Length [m] Max. 100 m
1408599	93H	4.5
Minimum order amount = 25		
Increments: 0.2 ... 3 m = 0.1 m > 3 m = 0.5 m		

M12 connector, SPEEDCON	M12 socket, SPEEDCON	M12 socket, SPEEDCON	M12 flush-type socket, rear mounting
			
MRD SCO	FSD SCO	FRD SCO	FSDBP
Ordering data	Ordering data	Ordering data	Ordering data
Order No.	Order No.	Order No.	Order No.
Variable 1408596	Variable 1408590	Variable 1408584	1 m 1419135 2 m 1419136 5 m 1419137
Variable 1408595	Variable 1408589	Variable 1408583	2 m 1419146
Variable 1408594	Variable 1408587	Variable 1408582	
Variable 1408593	Variable 1408586	Variable 1408581	
Variable 1408592	Variable 1408585	Variable 1408580	

	Technical data	Technical data
	EtherCAT® [93G]	EtherCAT® [93H]
Transmission characteristics (category)	CAT5	CAT5
Cable structure	1x4xAWG22/7; SF/TQ	1x4xAWG22/7; SF/TQ
Conductor cross section	4x 0.34 mm ²	4x 0.34 mm ²
Conductor structure for signal	7x 0.25 mm	7x 0.25 mm
AWG signal line	22	22
Cable diameter	6.5 mm	6.5 mm
Conductor resistance	≤ 120 Ω/km	≤ 120 Ω/km
Type of shield	Aluminum-coated foil, tinned copper braided shield	Aluminum-coated foil, tinned copper braided shield
Conductor material	Tin-plated Cu litz wires	Tin-plated Cu litz wires
Outer sheath material	PVC	PUR
Color of outer sheath	Green RAL 6018	Green RAL 6018
Color, single wire	White, yellow, blue, orange	White, yellow, blue, orange
Ambient temperature		
Fixed installation	[°C] -40 ... 70	-40 ... 70
Flexible installation	[°C] -40 ... 70	-40 ... 70

Assembled cables, Ethernet, 4-pos., shielded, CAT5



Ethernet

Open cable end



OE

M8 connector



M8MS

RJ45 connector, IP20



R4AC

M8 connector



M8 socket



M8MS

Ordering data

Order No.

1 m	1407344
2 m	1407345
5 m	1407346
10 m	1407347

Variable	1408719
----------	---------

M8FS

Ordering data

Order No.

Variable	1408716
----------	---------

1 m	1407348
2 m	1407349
5 m	1407350
10 m	1407351
Variable	1408718

Variable	1408715
----------	---------

1 m	1407352
2 m	1407353
5 m	1407354
10 m	1407355
Variable	1408717

Variable	1408714
----------	---------

Information for products with fixed cable lengths:

Products with fixed cable lengths are produced with the 93B cable type and are available from stock.

Ordering data for cables with variable cable lengths:

For a network cable, type 93B, fitted with a straight M8 connector at one end and an RJ45 connector with IP20 protection at the other end, and 4.5 m in length, the ordering data is as follows:

Order No.	Cable type	Length [m] Max. 100 m
1408717	93B	4.5
Minimum order amount = 25		
Increments: 0.2 ... 3 m = 0.1 m > 3 m = 0.5 m		

Pin	M8	RJ45	Wire color	Signal
2	1	YE	Yellow	TD+
3	2	OG	Orange	TD-
1	3	WH	White	RD+
4	6	BU	Blue	RD-

Technical data

PROFINET PVC stranded CAT5 [93B]

Transmission characteristics (category)
Cable structure
Conductor cross section
Conductor structure for signal
AWG signal line
Cable diameter
Conductor resistance
Type of shield

Conductor material
Outer sheath material
Color of outer sheath
Color, single wire

Ambient temperature
Fixed installation
Flexible installation

CAT5
1x4xAWG22/7; SF/TQ
4x 0.34 mm²
7x 0.25 mm
22
6.5 mm
≤ 120 Ω/km
Aluminum-coated foil, tinned copper braided shield
Tin-plated Cu litz wires
PVC
Green RAL 6018
White, yellow, blue, orange

Fixed installation	[°C]	-40 ... 70
Flexible installation	[°C]	-40 ... 70

Data connectors and cables

Network components - assembled cables

Assembled cables,
Ethernet, 4-pos.,
shielded, CAT5



Ethernet

Open cable end



OE

RJ45 connector, IP20



R4AC

RJ45 connector, Version 6



R4MC

RJ45 connector,
Version 14, metal



R4RC

RJ45 connector, Version 14,
plastic



R4QC

M12 connector, SPEEDCON



MSD SCO

M12 connector, SPEEDCON



MRD SCO

RJ45 connector, IP20



R4AC

Ordering data

Order No.

1 m 1405633

Variable 1411827

1 m 1408933

2 m 1408934

5 m 1408935

10 m 1408936

Variable 1411831

RJ45 connector,
Version 6



R4MC

Ordering data

Order No.

2 m 1405675

Variable 1411828

2 m 1405921

Variable 1411832

1 m 1408937

2 m 1408938

5 m 1408939

10 m 1408940

Variable 1411835

RJ45 connector,
Version 14, metal



R4RC

Ordering data

Order No.

5 m 1405743

Variable 1411829

5 m 1405992

Variable 1411833

1 m 1408941

2 m 1408942

5 m 1408943

10 m 1408945

Variable 1411836

Information for products with fixed cable length:

Products with fixed cable length are produced with the 93E cable type and are available from stock.

Ordering data for cables with variable cable length:

For a network cable, type 93E, fitted with a straight M12 connector at one end and an RJ45 connector with IP20 protection at the other end, and 4.5 m in length, the ordering data is as follows:

Order No.	Cable type	Length [m] Max. 100 m
1408712	93E	4.5
Minimum order amount = 25		
Increments: 0.2 ... 3 m = 0.1 m > 3 m = 0.5 m		

Cable description	Cable type	Pin		Wire color	Signal
		M12	RJ45		
PUR stranded - blue, 2 x 2, CAT5	93E	1	1	WHOG	TD+
		3	2	OG	TD-
		2	3	WHGN	RD+
		4	6	GN	RD-

RJ45 connector, Version 14, plastic	M12 connector, SPEEDCON	M12 connector, SPEEDCON	M12 socket, SPEEDCON	M12 socket, SPEEDCON	M12 flush-type socket, rear mounting
					
R4QC	MSD SCO	MRD SCO	FSD SCO	FRD SCO	FSDBP
Ordering data	Ordering data	Ordering data	Ordering data	Ordering data	Ordering data
Order No.	Order No.	Order No.	Order No.	Order No.	Order No.
	1 m 1407356 2 m 1407357 5 m 1407358 10 m 1407359 Variable 1408713	Variable 1408705	1 m 1407380 2 m 1407381 5 m 1407382 10 m 1407383 Variable 1408697	Variable 1408690	2 m 1405866
5 m 1405772 Variable 1411830	1 m 1407360 2 m 1407361 5 m 1407362 10 m 1407363 Variable 1408712	Variable 1408704	1 m 1407384 2 m 1407385 5 m 1407386 10 m 1407387 Variable 1408696	Variable 1408689	2 m 1406085
5 m 1406030 Variable 1411834	1 m 1407364 2 m 1407365 5 m 1407366 10 m 1407367 Variable 1408710	Variable 1408703	1 m 1407388 2 m 1407389 5 m 1407390 10 m 1407391 Variable 1408695	Variable 1408688	2 m 1406247
	1 m 1407368 2 m 1407369 5 m 1407370 10 m 1407371 Variable 1408709	Variable 1408702	1 m 1407392 2 m 1407393 5 m 1407394 10 m 1407395 Variable 1408694	Variable 1408687	2 m 1406519
1 m 1408947 2 m 1408948 5 m 1408946 10 m 1408949 Variable 1411837	1 m 1407372 2 m 1407373 5 m 1407374 10 m 1407375 Variable 1408707	Variable 1408701	1 m 1407396 2 m 1407397 5 m 1407398 10 m 1407399 Variable 1408693	Variable 1408686	2 m 1406603
	1 m 1407376 2 m 1407377 5 m 1407378 10 m 1407379 Variable 1408706	Variable 1408700	1 m 1407400 2 m 1407401 5 m 1407402 10 m 1407403 Variable 1408692	Variable 1408684	
		Variable 1408699	Variable 1408691	Variable 1408683	

Technical data

PUR ETHERNET 2x2 FLEX [93E]

Transmission characteristics (category)
Cable structure
Conductor cross section
Conductor structure for signal
AWG signal line
Cable diameter
Conductor resistance
Type of shield

CAT5
2x2xAWG26/7; SF/UTP
2x 2x 0.14 mm²
7x 0.16 mm
26
6.4 mm
≤ 290 Ω/km
Aluminum-coated foil, tinned copper braided shield

Conductor material
Outer sheath material
Color of outer sheath
Color, single wire

Bare Cu litz wires
PUR
water blue RAL 5021
white/orange-orange,
white/green-green

Ambient temperature

Fixed installation [°C] -40 ... 80
Flexible installation [°C] -20 ... 80

Network components - assembled cables

**Assembled cables,
Ethernet, 8-pos.,
shielded, CAT5**



Ethernet

	RJ45 connector, IP20	RJ45 connector, Version 6	RJ45 connector, Version 14, metal
	R4AC	R4MC	R4RC
	Ordering data	Ordering data	Ordering data
	Order No.	Order No.	Order No.
Open cable end			
	5 m 1407699	5 m 1407725	5 m 1407783
OE	Variable 1411838	Variable 1411839	Variable 1411840
RJ45 connector, IP20			
	1 m 1408950 2 m 1408951 5 m 1408952 10 m 1408953 Variable 1411842	5 m 1407932	5 m 1407990
R4AC			
RJ45 connector, Version 6			
		1 m 1408955 2 m 1408956 5 m 1408954 10 m 1408958 Variable 1411846	
R4MC			
RJ45 connector, Version 14, metal			
			1 m 1408961 2 m 1408962 5 m 1408959 10 m 1408963 Variable 1411847
R4RC			
RJ45 connector, Version 14, plastic			
R4QC			
M12 connector, SPEEDCON			
MS SCO			
M12 connector, SPEEDCON			
MR SCO			

Information for products with fixed cable length:

Products with fixed cable length are produced with the **94B** cable type and are available from stock.

Ordering data for cables with variable cable length:

For a network cable, type **94C**, fitted with a **straight M12 connector** at one end and an **RJ45 connector with IP20 protection** at the other end, and **4.5 m in length**, the ordering data is as follows:

Order No.	Cable type	Length [m] Max. 100 m
1408681	94C	4.5
Minimum order amount = 25		
Increments: 0.2 ... 3 m = 0.1 m > 3 m = 0.5 m		

Cable description	Cable type	Pin		Wire color	Signal
		M12	RJ45		
PUR stranded - blue, 4 x 2, CAT5	94B	6	1	WHOG	D1+
		4	2	OG	D1-
PUR suitable for drag chain applications - blue, 4 x 2, CAT5	94C	1	5	WHBU	D3+
		7	4	BU	D3-
		5	3	WHGN	D2+
		8	6	GN	D2-
		2	7	WHBN	D4+
		3	8	BN	D4-

RJ45 connector, Version 14, plastic	M12 connector, SPEEDCON	M12 connector, SPEEDCON	M12 socket, SPEEDCON	M12 socket, SPEEDCON	M12 flush-type socket, rear mounting
					
R4QC	MS SCO	MR SCO	FS SCO	FR SCO	FSBP
Ordering data	Ordering data	Ordering data	Ordering data	Ordering data	Ordering data
Order No.	Order No.	Order No.	Order No.	Order No.	Order No.
	1 m 1407404 2 m 1407405 5 m 1407406 10 m 1407407 Variable 1408682	Variable 1408675	1 m 1407439 2 m 1407440 5 m 1407441 10 m 1407442 Variable 1408665	Variable 1408657	5 m 1407877
5 m 1407819	1 m 1407414 2 m 1407415 5 m 1407416 10 m 1407417 Variable 1408681		1 m 1407443 2 m 1407444 5 m 1407445 10 m 1407446 Variable 1408664		5 m 1412082
Variable 1411841	1 m 1407422 2 m 1407423 5 m 1407424 10 m 1407425 Variable 1408679	Variable 1408671	1 m 1407451 2 m 1407452 5 m 1407453 10 m 1407454 Variable 1408662	Variable 1408653	5 m 1412231
	1 m 1407426 2 m 1407427 5 m 1407428 10 m 1407429 Variable 1408678	Variable 1408670	1 m 1407455 2 m 1407456 5 m 1407457 10 m 1407458 Variable 1408661	Variable 1408652	5 m 1412503
1 m 1408965 2 m 1408966 5 m 1408964 10 m 1408967 Variable 1411848	1 m 1407430 2 m 1407431 5 m 1407432 10 m 1407433 Variable 1408677	Variable 1408668	1 m 1407459 2 m 1407460 5 m 1407461 10 m 1407462 Variable 1408660	Variable 1408651	5 m 1412590
	1 m 1407434 2 m 1407435 5 m 1407436 10 m 1407438 Variable 1408676	Variable 1408667	1 m 1407463 2 m 1407464 5 m 1407465 10 m 1407466 Variable 1408659	Variable 1408650	
		Variable 1408666	Variable 1408658	Variable 1408649	

	Technical data	Technical data
	Ethernet, flexible, CAT5 [94B]	Ethernet drag chain CAT5 [94C]
Transmission characteristics (category)	CAT5	CAT5
Cable structure	4x2xAWG26/7; SF/UTP	4x2xAWG26/19; S/UTP
Conductor cross section	4x 2x 0.14 mm ²	4x 2x 0.14 mm ²
Conductor structure for signal	7x 0.16 mm	19x 0.10 mm
AWG signal line	26	26
Cable diameter	6.4 mm	6.9 mm
Conductor resistance	≤ 290 Ω/km	≤ 290 Ω/km
Type of shield	Aluminum-coated foil, tinned copper braided shield	Tinned copper braided shield
Conductor material	Bare Cu litz wires	Bare Cu litz wires
Outer sheath material	PUR	PUR
Color of outer sheath	water blue RAL 5021	water blue RAL 5021
Color, single wire	white/blue-blue, white/orange-orange, white/green-green, white/brown-brown	white/blue-blue, white/orange-orange, white/green-green, white/brown-brown
Ambient temperature		
Fixed installation	[°C] -40 ... 80	-40 ... 80
Flexible installation	[°C] -20 ... 80	-20 ... 80

**Assembled cables,
Ethernet, 8-pos.,
shielded, CAT6_A**



Ethernet

	RJ45 connector, IP20	RJ45 connector, Version 6	RJ45 connector, Version 14, metal
	R4AC	R4MC	R4RC
	Ordering data	Ordering data	Ordering data
	Order No.	Order No.	Order No.
Open cable end			
OE	Variable	Variable	Variable
	1411853	1415639	1415637
RJ45 connector, IP20			
R4AC	1 m		
	1418866		
	2 m		
	1408360		
	5 m		
	1418879		
	10 m		
	1408367		
RJ45 connector, Version 6	Variable	Variable	Variable
	1411854	1414321	1411855
R4MC			Variable
RJ45 connector, Version 14, metal			
R4RC			Variable
RJ45 connector, Version 14, plastic			
R4QC			
M12 connector, SPEEDCON			
MSX SCO			

Information for products with fixed cable lengths:



Products with fixed cable lengths are produced with the **94F** cable type and are available from stock.

Ordering data for cables with variable cable lengths:

For a network cable, type **94F**, fitted with a **straight M12 connector** at one end and an **RJ45 connector with IP20 protection** at the other end, and **4.5 m in length**, the ordering data is as follows:

Order No.	Cable type	Length [m] Max. 100 m
1408647	94F	4.5
Minimum order amount = 25		
Increments: 0.2 ... 3 m = 0.1 m > 3 m = 0.5 m		

Cable description	Cable type	Pin		Wire color	Signal
		M12	RJ45		
PUR stranded - blue, 4 x 2, CAT6 _A	94F	1	1	WHOG	D1+
		2	2	OG	D1-
		7	5	WHBU	D3+
		8	4	BU	D3-
		3	3	WHGN	D2+
		4	6	GN	D2-
5	7	WHBN	D4+		
6	8	BN	D4-		

RJ45 connector, Version 14, plastic	M12 connector, SPEEDCON	M12 flush-type socket, rear mounting
		
R4QC	MSX SCO	FSBPX
Ordering data	Ordering data	Ordering data
Order No.	Order No.	Order No.
	1 m 1407467	0.5 m 1424135
	2 m 1407468	1 m 1424148
	5 m 1407469	2 m 1424151
	10 m 1407470	5 m 1424164
Variable 1415638	Variable 1408648	
	1 m 1407471	
	2 m 1407472	
	5 m 1407473	
	10 m 1407474	
Variable 1411856	Variable 1408647	

	1 m 1407475	
	2 m 1407476	
	5 m 1407477	
	10 m 1407478	
	Variable 1408646	
	1 m 1407479	
	2 m 1407480	
	5 m 1407481	
	10 m 1407482	
Variable 1414324	Variable 1408645	
	1 m 1407483	
	2 m 1407484	
	5 m 1407485	
	10 m 1407486	
	Variable 1408644	

Technical data	
Ethernet 10 Gbit [94F]	
Transmission characteristics (category)	CAT6 _A
Cable structure	4x2xAWG26/7; S/FTP
Conductor cross section	4x 2x 0.14 mm ²
Conductor structure for signal	7x 0.16 mm
AWG signal line	26
Cable diameter	6.4 mm
Conductor resistance	≤ 290 Ω/km
Type of shield	Tinned copper braided shield
Type of pair shielding	Aluminum-lined foil
Conductor material	Bare Cu litz wires
Outer sheath material	PUR
Color of outer sheath	water blue RAL 5021
Color, single wire	white/blue-blue, white/orange-orange, white/green-green, white/brown-brown
Ambient temperature	
Fixed installation	[-20 ... 80 °C]
Flexible installation	[-20 ... 80 °C]

Assembled cables for railway applications, Ethernet, shielded, CAT6_A



M12 connector, SPEEDCON



MSX SCO

Ordering data

Order No.

Open cable end



OE

M12 connector, SPEEDCON, straight



MSX SCO

2 m	1415599
5 m	1415600
10 m	1415601

2 m	1415595
5 m	1415598

Pin M12	Wire color	Signal
1	WHOG	D1+
2	OG	D1-
7	WHBU	D3+
8	BU	D3-
3	WHGN	D2+
4	GN	D2-
5	WHBN	D4+
6	BN	D4-

Transmission characteristics (category)
Cable structure
Conductor cross section
Conductor structure for signal
AWG signal line
Cable diameter
Conductor resistance
Type of shield

Type of pair shielding

Conductor material
Outer sheath material

Color of outer sheath
Color, single wire

Ambient temperature

Fixed installation [°C]

Flexible installation [°C]

Technical data

Ethernet for rail applications [94S]

CAT7

4x2xAWG26/7; S/FTP

4x 2x 0.14 mm²

7x 0.16 mm

26

6.6 mm

≤ 145 Ω/km

Tinned copper braided shield

Aluminum-lined polyester foil

Tin-plated Cu litz wires

Elastomer electron beam cross-linked

Black

White-blue, white-orange, white-green, white-brown

-40 ... 80

- ... -

**Assembled cables,
Ethernet hybrid, 4+4-pos.,
shielded, CAT5**



Ethernet



Open cable end



OE

M12 connector, SPEEDCON



MSY SCO

**M12 connector,
SPEEDCON**



MSY SCO

**M12 flush-type socket,
rear mounting**



FSBPY

Ordering data

Order No.

1 m	1407487
2 m	1407488
5 m	1407489
10 m	1407490
Variable	1408642

Ordering data

Order No.

0.5 m	1407504
1 m	1407505
2 m	1407506
5 m	1407507

1 m	1407491
2 m	1407492
5 m	1407493
10 m	1407494
Variable	1408641

**Information for products with
fixed cable lengths:**

Products with fixed cable lengths are produced with the 94H cable type and are available from stock.

**Ordering data for cables
with variable cable lengths:**

For a network cable, type 94H, fitted with a straight M12 connector at one end and an RJ45 connector with IP20 protection at the other end, and 4.5 m in length, the ordering data is as follows:

Order No.	Cable type	Length [m] Max. 100 m
1408717	94H	4.5
Minimum order amount = 25		
Increments: 0.2 ... 3 m = 0.1 m > 3 m = 0.5 m		

Pin M12	Wire color	Signal
1	WHOG	TD+
2	OG	TD-
3	WHGN	RD+
4	GN	RD-
5	BU	
6	WH	
7	BN	
8	BK	

Transmission characteristics (category)
Cable structure
Conductor cross section for signal [mm²]
Conductor structure for signal
AWG signal line
Conductor cross section for power [mm²]
Conductor structure for power
AWG power supply
Cable diameter
Type of shield

Conductor material
Outer sheath material
Color of outer sheath
Color, single wire

Ambient temperature
Fixed installation [°C]
Flexible installation [°C]

Technical data

Ethernet hybrid [94H]
CAT5
1x4xAWG26+1x4xAWG20
0.15 [mm²]
19x 0.10 mm
26
0.6 [mm²]
19x 0.20 mm
20
7.6 mm
Tinned copper braided shield
Bare Cu litz wires
PUR
Black RAL 9005
White/orange, orange, white/green, green, white, blue, brown, black

Fiber optic patch cables

Connectors:

- LC
- SC duplex
- B-FOC (ST®)

Fixed lengths:

- 1 m
- 2 m
- 5 m

Fiber types:

- Single-mode fiberglass (SM)

Sheath colors:

- Single mode: Yellow

Technical Data:

- Halogen-free
- Flame-retardant
- No corrosive or toxic fumes
- External dimensions: 2.8 mm x 5.7 mm



LC connector

		Technical data		
Cable, properties		Individual wire diameter	2.8 mm	
Outer sheath, material		FRNC		
External sheath, strain relief elements		Non-metallic, aramide fiber		
Lateral pressure, long-term		60 N/cm		
Tensile strength short-term/long-term		600 N		
Halogen-free		According to IEC 60754-2		
General data				
Ambient temperature (storage/transport)		-25 °C ... 70 °C		
Ambient temperature (installation)		-5 °C ... 50 °C		
Ambient temperature (operation)		-5 °C ... 70 °C		
		Ordering data		
Description	Length of cable	Type	Order No.	Pcs. / Pkt.
FO patch cable with single-mode fiberglass (OS1)				
- LC connector to LC, SC duplex or B-FOC connector				
	1 m	FL SM PATCH 1,0 LC-LC	2989187	1
	2 m	FL SM PATCH 2,0 LC-LC	2989284	1
	5 m	FL SM PATCH 5,0 LC-LC	2901826	1
FO patch cable with single-mode fiberglass (OS1)				
- SC duplex connector to SC duplex or B-FOC connector				
	1 m			
	2 m			
	5 m			
FO patch cable with single-mode fiberglass (OS1)				
- B-FOC connector to B-FOC connector				
	1 m			
	2 m			
	5 m			



SC duplex connector



B-FOC connector

Technical data
2.8 mm
FRNC
Non-metallic, aramide fiber
60 N/cm
600 N
According to IEC 60754-2
-25 °C ... 70 °C
-5 °C ... 50 °C
-5 °C ... 70 °C

Technical data
2.8 mm
FRNC
Non-metallic, aramide fiber
60 N/cm
600 N
According to IEC 60754-2
-25 °C ... 70 °C
-5 °C ... 50 °C
-5 °C ... 70 °C

Ordering data		
Type	Order No.	Pcs. / Pkt.
FL SM PATCH 1,0 LC-SC	2989190	1
FL SM PATCH 2,0 LC-SC	2989297	1
FL SM PATCH 5,0 LC-SC	2901827	1
FL SM PATCH 1,0 SC-SC	2901829	1
FL SM PATCH 2,0 SC-SC	2901830	1
FL SM PATCH 5,0 SC-SC	2901831	1

Ordering data		
Type	Order No.	Pcs. / Pkt.
FL SM PATCH 1,0 LC-ST	2989242	1
FL SM PATCH 2,0 LC-ST	2989349	1
FL SM PATCH 5,0 LC-ST	2901828	1
FL SM PATCH 1,0 SC-ST	2901832	1
FL SM PATCH 2,0 SC-ST	2901833	1
FL SM PATCH 5,0 SC-ST	2901834	1
FL SM PATCH 1,0 ST-ST	2901836	1
FL SM PATCH 2,0 ST-ST	2901837	1
FL SM PATCH 5,0 ST-ST	2901838	1

Data connectors and cables

Network components - assembled fiber optic cables

Fiber optic outdoor cables, sold by the meter

- Robust round cable for outdoor installation
- Ozone and UV resistant
- Watertight lengthwise
- Integrated vapor barrier and rodent-proof scrim



GOF fiber type



PCF fiber type

	Technical data		Technical data	
	FOC-OE-OE-GB01/...	FOC-OE-OE-GB02/...	FOC-OE-OE-GB03/...	FOC-OE-OE-HB01/...
Cable data				
Cable abbreviation in accordance with IEC 61977:2010	02-G50/FJ(ZNG)H-...22	02-G50/FJ(ZN)Z-...22	04-G50/FJ(ZNG)H-...22	02-H200/VJ(ZNG)H-...22
Fibers	50/125 µm OM2	50/125 µm OM2	50/125 µm OM2	200/230 µm
Attenuation, typical	2.7 dB/km (at 850 nm); 0.8 dB/km (at 1300 nm)	2.7 dB/km (at 850 nm); 0.8 dB/km (at 1300 nm)	2.7 dB/km (at 850 nm); 0.8 dB/km (at 1300 nm)	10 dB/km (at 660 nm), 8 dB/km (at 850 nm)
Outer sheath				
Material	PE	PUR	PE	PE
Color	Black	Black	Black	Black
Strain relief elements	Aramide/glass fibers	Non-metallic, aramide fiber	Aramide/glass fibers	Aramide/glass fibers
Diameter	7.5 mm	7.5 - 8 mm	9 mm	7.5 mm
Individual wire				
Color	Black/orange	Black/orange	Black/orange	Black/orange
Diameter	2.2 mm	2.2 mm	2.15 mm	2.2 mm
Strain relief elements	Non-metallic, aramide fibers	Non-metallic, aramide fibers	Non-metallic, aramide fibers	Non-metallic, aramide fibers
General data				
Weight	59.00 kg/km	46.00 kg/km	90.00 kg/km	67.00 kg/km
Ambient temperature (operation)	-40 °C ... 70 °C	-40 °C ... 85 °C	-40 °C ... 70 °C	-20 °C ... 70 °C
Ambient temperature (storage/transport)	-45 °C ... 70 °C	-45 °C ... 85 °C	-40 °C ... 70 °C	-25 °C ... 70 °C
Ambient temperature (installation)	-20 °C ... 60 °C	-20 °C ... 60 °C	-20 °C ... 60 °C	-10 °C ... 60 °C
Halogen-free as per:	Complying with IEC 60754-1/2	Complying with IEC 60754-1/2	Complying with IEC 60754-1/2	Complying with IEC 60754-1/2

	Ordering data			Ordering data		
	Type	Order No.	Pcs. / Pkt.	Type	Order No.	Pcs. / Pkt.
Description						
GOF outdoor cable, 2-wire, full breakout cable for fixed installation	FOC-OE-OE-GB01/...	1406429	1			
GOF outdoor cable, 2-wire, full breakout cable for flexible installation	FOC-OE-OE-GB02/...	1406430	1			
GOF outdoor cable, 4-wire, full breakout cable for fixed installation	FOC-OE-OE-GB03/...	1406431	1			
PCF outdoor cable, 2-wire, full breakout cable for fixed installation	FOC-OE-OE-HB01/...	1406432	1			

Ordering example for cables with variable cable lengths:

For fiber optic outdoor cable type **GB02** with a cable length of 34.0 m, the ordering data is as follows:

Order No.	Length [m] Max. 1000 m
1406430	34.0
	Increment: 1.0 m ... 1000 m = 1.0 m

Data connectors and cables

Network components - assembled fiber optic cables

Zip cord fiberglass cable for assembly, OM2

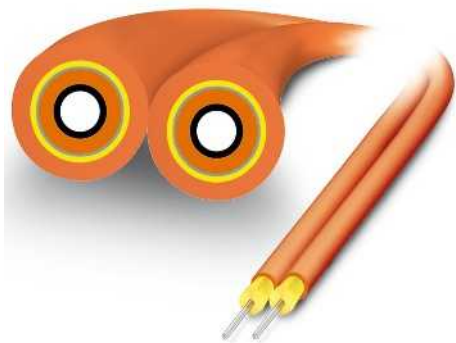

- Multi-mode patch cable for indoor installation
- Ideal for use in distributor systems and for connecting termination devices
- 2.8 mm single elements made from halogen-free and flame-retardant material
- UL approval type OFNR (riser) for USA and Canada

	Free end	SC-RJ connector, IP20	SC duplex connector, IP20
	OE	SCRJ	SCDUP
	Ordering data	Ordering data	Ordering data
	Order No.	Order No.	Order No.
Free end			
	Variable	1411561	
SC-RJ connector, IP20			
		1 m 1409813 2 m 1400697	1 m 1409810 2 m 1400690
SCRJ		Variable 1405703	Variable 1405700
SC duplex connector, IP20			1 m 1409798 2 m 1400685
			Variable 1405697
SCDUP			
B-FOC (ST®) connector, IP20			
BFOC			
LC duplex connector, IP20			1 m 1409790 2 m 1400639
			Variable 1405691
LC			

Ordering example for configured cable:

For a zip cord fiberglass cable, fitted with an IP20 SC duplex connector at one end and an IP20 SC-RJ connector at the other end, and 15 m in length, the ordering data is as follows:

Order No.	Length [m]
1405700	15

Length:	Min. 1 m Max. 1000 m
Increment:	1 m 1 m ... 1000 m

B-FOC (ST®) connector,
IP20

LC duplex connector,
IP20



BFOC

LC

Ordering data

Ordering data

Order No.

Order No.

1 m 1409822
2 m 1400706

1 m 1409793
2 m 1400682

Variable 1405710

Variable 1405694

1 m 1409819
2 m 1400703

Variable 1405708

1 m 1409824
2 m 1404768

Variable 1405712

1 m 1409816
2 m 1400701

1 m 1409787
2 m 1400604

Variable 1405706

Variable 1405688

Technical data

Cable data

Cable abbreviation in accordance with IEC 61977:2010

Fibers

Attenuation, typical

I-V(ZN)H

50/125 µm OM2

2.7 dB/km (at 850 nm);
0.8 dB/km (at 1300 nm)

Outer sheath

Material

Color

Diameter

Strain relief elements

Individual wire

Structure

Color

Diameter

General data

Weight

Ambient temperature (operation)

Ambient temperature (storage/transport)

Ambient temperature (installation)

Halogen-free as per:

-

Orange

2.8 - 5.7 mm

-

-

-

900 µm

15.80 kg/km

-10 °C ... 70 °C

-25 °C ... 70 °C

-5 °C ... 50 °C

Complying with IEC 60754-1/2

Data connectors and cables

Network components - assembled fiber optic cables

Zip cord fiberglass cable for assembly, OM3



- Multi-mode patch cable for indoor installation
- Ideal for use in distributor systems and for connecting termination devices
- 2.8 mm single elements made from halogen-free and flame-retardant material
- UL approval type OFNR (riser) for USA and Canada
- Low-bend fiber
- Data rate: up to 10 Gbps up to 300 m

	Free end	SC-RJ connector, IP20	SC duplex connector, IP20
	OE	SCRJ	SCDUP
	Ordering data	Ordering data	Ordering data
	Order No.	Order No.	Order No.
Free end			
	OE		
SC-RJ connector, IP20			
		SCRJ	
SC duplex connector, IP20			
			SCDUP
LC duplex connector, IP20			
			LC
	Variable	1411563	
		1 m 1409814	1 m 1409811
		2 m 1400699	2 m 1400691
		Variable 1405704	Variable 1405701
			1 m 1409799
			2 m 1400688
			Variable 1405698
			1 m 1409791
			2 m 1400673
			Variable 1405692

Ordering example for configured cable:

For a zip cord fiberglass cable, fitted with an IP20 SC duplex connector at one end and an IP20 SC-RJ connector at the other end, and 15 m in length, the ordering data is as follows:

Order No.	Length [m]
1405701	15

Length:	Min. 1 m Max. 1000 m
Increment:	1 m 1 m ... 1000 m

B-FOC (ST®) connector, IP20



BFOC

Ordering data

Order No.

LC duplex connector, IP20



LC

Ordering data

Order No.

1 m 1409823
2 m 1400711

Variable 1405711

1 m 1409821
2 m 1400705

Variable 1405709

1 m 1409818
2 m 1400702

Variable 1405707

1 m 1409796
2 m 1400683

Variable 1405695

1 m 1409788
2 m 1400621

Variable 1405695

Technical data

Cable data

Cable abbreviation in accordance with IEC 61977:2010

Fibers

Attenuation, typical

Smallest bending radius, fixed installation

Smallest bending radius, movable installation

Outer sheath

Material

Color

Diameter

Strain relief elements

Individual wire

Structure

Color

Diameter

General data

Weight

Ambient temperature (operation)

Ambient temperature (storage/transport)

Ambient temperature (installation)

Halogen-free as per:

I-V(ZN)H

50/125 µm OM3

2.5 dB/km (at 850 nm),
0.7 dB/km (at 1300 nm)

15 nm

30 nm

-

Aqua

2.8 - 5.7 mm

-

-

-

-

15.80 kg/km

-10 °C ... 70 °C

-25 °C ... 70 °C

-5 °C ... 50 °C

Complying with IEC 60754-1/2

Data connectors and cables

Network components - assembled fiber optic cables

Zip cord fiberglass cable for assembly, OM4

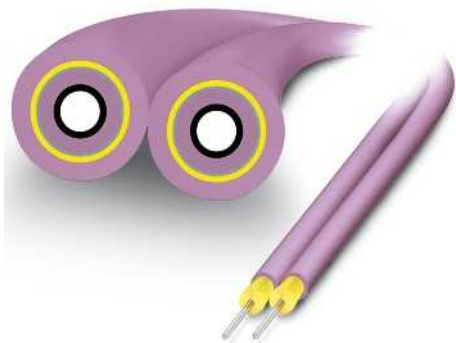

- Multi-mode patch cable for indoor installation
- Ideal for use in distributor systems and for connecting termination devices
- 2.8 mm single elements made from halogen-free and flame-retardant material
- UL approval type OFNR (riser) for USA and Canada
- Low-bend fiber
- Data rate: up to 10 Gbps up to 550 m

	Free end	SC-RJ connector, IP20	SC duplex connector, IP20
	OE	SCRJ	SCDUP
	Ordering data	Ordering data	Ordering data
	Order No.	Order No.	Order No.
Free end			
	OE		
SC-RJ connector, IP20	Variable	1411564	
SCRJ			
SC duplex connector, IP20			
SCDUP			
LC duplex connector, IP20			
LC			
		1 m 1409815 2 m 1400700	1 m 1409812 2 m 1400695
		Variable 1405705	Variable 1405702
			1 m 1409801 2 m 1400689
			Variable 1405699
			1 m 1409792 2 m 1400681
			Variable 1405693

Ordering example for configured cable:

For a zip cord fiberglass cable, fitted with an IP20 SC duplex connector at one end and an IP20 SC-RJ connector at the other end, and 15 m in length, the ordering data is as follows:

Order No.	Length [m]
1405702	15

Length:	Min. 1 m Max. 1000 m
Increment:	1 m 1 m ... 1000 m

LC duplex connector,
IP20

LC

Ordering data

Order No.

1 m	1409797
2 m	1400684

Variable	1405696
----------	---------

1 m	1409789
2 m	1400622

Variable	1405690
----------	---------

Technical data

Cable data

Cable abbreviation in accordance with IEC 61977:2010

Fibers

Attenuation, typical

I-V(ZN)H

50/125 µm OM4

2.5 dB/km (at 850 nm),
0.7 dB/km (at 1300 nm)

Smallest bending radius, fixed installation

Smallest bending radius, movable installation

Outer sheath

Material

Color

Diameter

Strain relief elements

Individual wire

Structure

Color

Diameter

General data

Weight

Ambient temperature (operation)

Ambient temperature (storage/transport)

Ambient temperature (installation)

Halogen-free as per:

15 nm

30 nm

-

Violet

2.8 - 5.7 mm

-

-

-

-

15.80 kg/km

-10 °C ... 70 °C

-25 °C ... 70 °C

-5 °C ... 50 °C

Complying with IEC 60754-1/2

M12 connector, for assembly



INTERBUS



PROFIBUS DP



Technical data

M12 circular connector according to:

Pollution degree
Degree of protection
Connection method
Electrical data
Rated voltage
Rated current
Insulation resistance
Material data
Contact material
Contact surface material
Contact carrier material
Inflammability class according to UL 94
Coding
No. of pos.
Temperature data
Plug/socket

Spring connection	Screw connection
IEC 61076-2-101	IEC 61076-2-101
3	3
IP67	IP67
Spring connection	Screw connection
60 V DC	60 V DC
4 A	4 A
≥ 100 MΩ	≥ 100 MΩ
CuSn	CuSn
Ni/Au	Au
TPU	PA 66
V0	HB
B-coded	B - inverse
5	5
-40 ... 85	-40 ... 85



Technical data

Spring connection	Screw connection
IEC 61076-2-101	IEC 61076-2-101
3	3
IP67	IP67
Spring connection	Screw connection
60 V DC	60 V DC
4 A	4 A
≥ 100 MΩ	≥ 100 MΩ
CuSn	CuSn
Ni/Au	Au
TPU	PA 66
V0	HB
B-coded	B - inverse
2	5
-40 ... 85	-40 ... 85

Ordering data

Description
Connectors
Socket, straight
Plug, straight
Socket, angled
Plug, angled

Order No.	Pcs. / Pkt.	Order No.	Pcs. / Pkt.
Spring connection		Screw connection	
1432826	1	1507777	1
1432800	1	1507764	1
1432839	1	1430420	1
1432813	1	1430417	1

Ordering data

Order No.	Pcs. / Pkt.	Order No.	Pcs. / Pkt.
Springconnection		Screw connection	
1432868	1	1507777	1
1432842	1	1507764	1
1432871	1	1430420	1
1432855	1	1430417	1

new



PROFIBUS DP, PROFIBUS PA



CANopen®, DeviceNet™



CC-Link



Technical data	
PROFIBUS DP IEC 61076-2-101 3 IP65/IP67 IDC connection technology	PROFIBUS PA IEC 61076-2-101 3 IP65/IP67 IDC connection technology
60 V DC 4 A ≥ 100 MΩ	30 V DC 4 A ≥ 100 MΩ
CuSn Ni/Au PA V0 B-coded 2	CuSn Ni/Au PA V0 A-coded 2
-40 ... 85	-40 ... 85

Technical data	
Spring connection IEC 61076-2-101 3 IP65/IP67 Spring connection	Screw connection IEC 61076-2-101 3 IP67 Screw connection
60 V DC 4 A ≥ 100 MΩ	60 V DC 4 A ≥ 100 MΩ
CuSn Ni/Au TPU V0 A - standard 5	CuSn Au PA 66 HB A - standard 5
-40 ... 85	-40 ... 85

Technical data	
Spring connection IEC 61076-2-101 3 IP67 Spring connection	
60 V DC 4 A ≥ 100 MΩ	
CuSn Ni/Au PA 66 V0 A - standard 4	
-40 ... 85	

Ordering data			
Order No.	Pcs. / Pkt.	Order No.	Pcs. / Pkt.
PROFIBUS DP		PROFIBUS PA	
1413932	1	1413934	1
1413931	1	1413933	1

Ordering data			
Order No.	Pcs. / Pkt.	Order No.	Pcs. / Pkt.
Spring connection		Screw connection	
1432787	1	1508365	1
1432761	1	1508352	1
1432790	1		
1432774	1		

Ordering data			
Order No.	Pcs. / Pkt.	Order No.	Pcs. / Pkt.
Spring connection			
1559770	1		
1559767	1		

M12 flush-type connector, shielded



with 0.5 m long litz wires,
front mounting



Technical data

M12 circular connector according to:	IEC 61076-2-101
Pollution degree	3
Degree of protection	IP67
Connection method	Individual wires
Electrical data	
Rated voltage	250 V
Rated current	4 A
Contact resistance	≤ 3 mΩ
Insulation resistance	≥ 100 MΩ
Material data	
Material contact/contact surface	CuZn / Ni/Au
Contact carrier material	PA66 GF
Inflammability class according to UL 94	V0
Temperature data	
Plug/socket	-25 ... 85 [°C]

Ordering data

Description	Coding	Type	Order No.	Pcs. / Pkt.
Device connectors				
Socket	A - standard	SACC-E-M12FS-4CON-PG9/0,5 FFVA	1431429	1
Plug	A - standard	SACC-E-M12MS-4CON-PG9/0,5 FFVA	1431432	1

Flush-type connector, with pre-assembled cable, type 900



Rear mounting



Front mounting, can be positioned

ERC

Technical data

M16 fastening thread	Pg9 fastening thread
IEC 61076-2-101	IEC 61076-2-101
3	3
IP67	IP67
60 V	60 V
4 A	4 A
≤ 3 mΩ	≤ 3 mΩ
≥ 100 MΩ	≥ 100 MΩ
CuZn / Ni/Au	CuZn / Ni/Au
PA 66	PA 66
V0	V0
-25 ... 85	-25 ... 85

ERC

Technical data

M16 fastening thread
IEC 61076-2-101
3
IP67
60 V
4 A
≤ 3 mΩ
≥ 100 MΩ
CuZn / Ni/Au
PA 66
V0
-25 ... 85

Ordering data

Order No.	Pcs. / Pkt.	Order No.	Pcs. / Pkt.
M16 fastening thread		Pg9 fastening thread	
1534546	1	1437601	1
1534504	1	1437643	1
1534559	1	1437614	1
1534517	1	1437656	1
1534562	1	1437627	1
1534520	1	1437669	1
1534575	1	1437630	1
1534533	1	1437672	1
1440164	10	1440177	10

Ordering data

Order No.	Pcs. / Pkt.	Order No.	Pcs. / Pkt.
M16 fastening thread			
1529742	1		
1529629	1		
1529755	1		
1530223	1		
1529768	1		
1529726	1		
1529771	1		
1529739	1		

M12 circular connector according to:

Pollution degree	
Degree of protection	
Electrical data	
Rated voltage	
Rated current	
Contact resistance	
Insulation resistance	
Material data	
Material contact/contact surface	
Contact carrier material	
Inflammability class according to UL 94	
Temperature data	
Plug/socket	[°C]

Flush-type connector, B-coded, with bus system cable, 6-wire, shielded, PUR halogen-free, green outer cable sheath, 3 x 2 x 0.25 mm²

Description	Cable length
Socket	0.5 m
Plug	0.5 m
Socket	1 m
Plug	1 m
Socket	2 m
Plug	2 m
Socket	5 m
Plug	5 m

EMC hexagonal nut with fine tothing, for all device connectors with:

M16 fastening thread	
Pg9 fastening thread	

Fieldbus components - M12 connectors

Flush-type connector, with pre-assembled cable, type 910



Rear mounting



Front mounting, can be positioned

ERC

Technical data

M12 circular connector according to:

Pollution degree	3
Degree of protection	IP67
Electrical data	
Rated voltage	60 V
Rated current	4 A
Contact resistance	≤ 3 mΩ
Insulation resistance	≥ 100 MΩ
Material data	
Material contact/contact surface	CuZn / Ni/Au
Contact carrier material	PA 66
Inflammability class according to UL 94	V0
Temperature data	
Plug/socket	[-25 ... 85] °C

M16 fastening thread	Pg9 fastening thread
IEC 61076-2-101	IEC 61076-2-101
3	3
IP67	IP67
60 V	60 V
4 A	4 A
≤ 3 mΩ	≤ 3 mΩ
≥ 100 MΩ	≥ 100 MΩ
CuZn / Ni/Au	CuZn / Ni/Au
PA 66	PA 66
V0	V0
-25 ... 85	-25 ... 85

ERC

Technical data

M16 fastening thread
IEC 61076-2-101
3
IP67
60 V
4 A
≤ 3 mΩ
≥ 100 MΩ
CuZn / Ni/Au
PA 66
V0
-25 ... 85

Ordering data

Description	Cable length
Flush-type connector , B-coded, with bus system cable, 2-wire, shielded, PUR halogen-free, violet outer cable sheath, 1 x 2 x 0.25 mm ²	
Socket	0.5 m
Plug	0.5 m
Socket	1 m
Plug	1 m
Socket	2 m
Plug	2 m
Socket	5 m
Plug	5 m
EMC hexagonal nut with fine toothing, for all device connectors with:	
M16 fastening thread	
Pg9 fastening thread	

Order No.	Pcs. / Pkt.	Order No.	Pcs. / Pkt.
M16 fastening thread		Pg9 fastening thread	
1534384	1	1437449	1
1534342	1	1437481	1
1534397	1	1437452	1
1534355	1	1437494	1
1534407	1	1437465	1
1534368	1	1437504	1
1534410	1	1437478	1
1534371	1	1437517	1
1440164	10		
		1440177	10

Ordering data

Order No.	Pcs. / Pkt.	Order No.	Pcs. / Pkt.
M16 fastening thread			
1525597	1		
1525555	1		
1525607	1		
1525568	1		
1519574	1		
1519561	1		
1525610	1		
1525571	1		

Flush-type connector, with pre-assembled cable, type 920

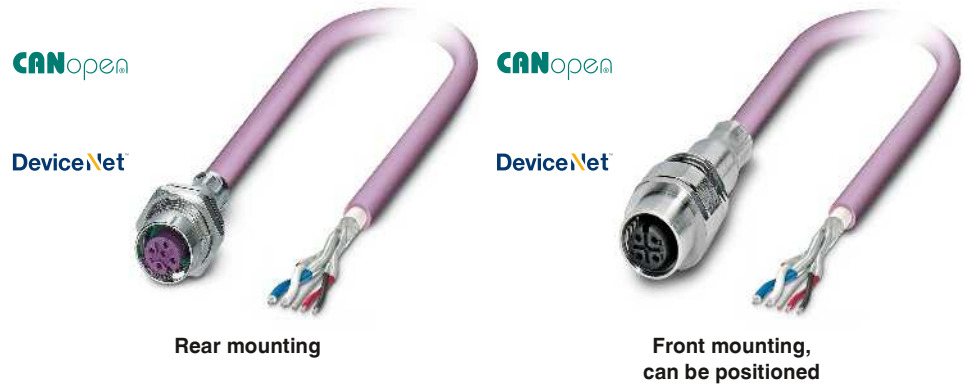

Rear mounting

Front mounting, can be positioned

ERC

ERC

M12 circular connector according to:

Pollution degree	3
Degree of protection	IP67
Electrical data	
Rated voltage	60 V
Rated current	4 A
Contact resistance	≤ 3 mΩ
Insulation resistance	≥ 100 MΩ
Material data	
Material contact/contact surface	CuZn / Ni/Au
Contact carrier material	PA 66
Inflammability class according to UL 94	V0
Temperature data	
Plug/socket	[°C]

Technical data	
M16 fastening thread	Pg9 fastening thread
IEC 61076-2-101	IEC 61076-2-101
3	3
IP67	IP67
60 V	60 V
4 A	2 A
≤ 3 mΩ	≤ 3 mΩ
≥ 100 MΩ	≥ 100 MΩ
CuZn / Ni/Au	CuZn / Ni/Au
PA 66	PA 66
V0	V0
-25 ... 85	-25 ... 85

Technical data	
M16 fastening thread	
IEC 61076-2-101	
3	
IP67	
60 V	
4 A	
≤ 3 mΩ	
≥ 100 MΩ	
CuZn / Ni/Au	
PA 66	
V0	
-25 ... 85	

Ordering data

Ordering data

Description	Cable length	M16 fastening thread		Pg9 fastening thread		M16 fastening thread			
		Order No.	Pcs. / Pkt.	Order No.	Pcs. / Pkt.	Order No.	Pcs. / Pkt.	Order No.	Pcs. / Pkt.
Flush-type connector, A-coded, with bus system cable, 4-wire, shielded, PUR halogen-free, violet outer cable sheath, 2 x 0.34 mm²; 2 x 0.25 mm²									
Socket	0.5 m	1534465	1	1437520	1	1525678	1		
Plug	0.5 m	1534423	1	1437562	1	1525623	1		
Socket	1 m	1534478	1	1437533	1	1525681	1		
Plug	1 m	1534436	1	1437575	1	1525636	1		
Socket	2 m	1534481	1	1437546	1	1525694	1		
Plug	2 m	1534449	1	1437588	1	1525649	1		
Socket	5 m	1534494	1	1437559	1	1525704	1		
Plug	5 m	1534452	1	1437591	1	1525652	1		
EMC hexagonal nut with fine tothing, for all device connectors with:									
M16 fastening thread		1440164	10						
Pg9 fastening thread				1440177	10				

Data connectors and cables

Fieldbus components - assembled cables

Assembled cables, INTERBUS, M12-SPEEDCON, and M12

Notes:
For information about the cable qualities, see page 440

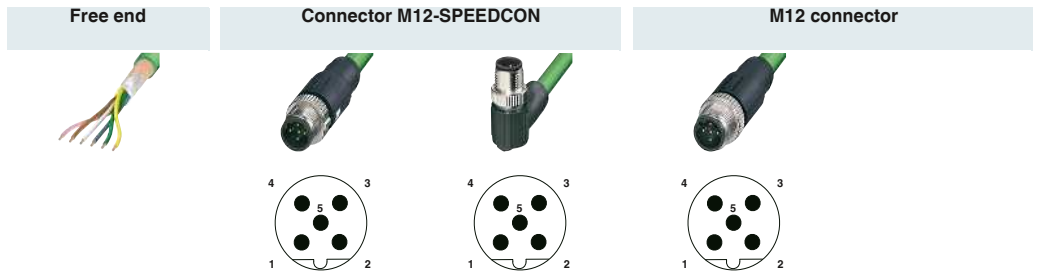

	Ordering data		Ordering data		Ordering data		Ordering data		Ordering data	
Free end	Order No.		Order No.		Order No.		Order No.		Order No.	
	Variable	2723123	2 m	1517877	Variable	1433184	2 m	1507065	Variable	1537983
			5 m	1517880			5 m	1507078		
			10 m	1517893			10 m	1507081		
			15 m	1517903			15 m	1507094		
M12-SPEEDCON socket, straight			0.3 m	1517958						
			0.5 m	1517961						
			1 m	1517974						
			2 m	1517916						
			5 m	1517929						
			10 m	1517932						
			15 m	1517945						
	Variable	1538018	Variable	1537996	Variable	1433210	Variable	1537983		
M12-SPEEDCON socket, angled										
	Variable	1433197	Variable	1433207	Variable	1433223				
M12 socket, straight										
			0.3 m	1507117			0.3 m	1507162		
			0.5 m	1507120			0.5 m	1507175		
			1 m	1507133			1 m	1507188		
			2 m	1507146			2 m	1507191		
			5 m	1538005			5 m	1507201		
			10 m				10 m	1507214		
			15 m				15 m	1507227		
	Variable	1538005	Variable		Variable		Variable	1538021		

Ordering example for cable with connector assembly:

For an INTERBUS bus cable, straight M12 socket to a straight M12 connector and a cable length of 34.5 m, the order data is as follows:

Order No.	Length [m]
1538021	34.5
	Max. 40 m
	Increments:
	0.2 ... 3.0 m = 0.1 m
	> 3.0 m = 0.5 m

Ordering example for cable without connector assembly:

For an INTERBUS bus cable with a cable length of 34.5 m, the order data is as follows:

Order No.	Length [m]
2723123	34.5
	Max. 400 m
	Increments:
	0.5 ... 400.0 m = 0.5 m

Technical data	
M12	
Rated voltage	[V] 60
Rated current	[A] 4
Contact resistance	≤ 5 mΩ
Contact material	CuSn
Contact surface material	Ni/Au
Material of grip body	TPU, hardly inflammable, self-extinguishing
Degree of protection	IP65 / IP67
Temperature data	
Plug/socket	[°C] -25 ... 90

Assembled cables, PROFIBUS DP, M12-SPEEDCON, and M12

Notes:
For information about the cable qualities, see page 440



	Ordering data		Ordering data		Ordering data		Ordering data	
Free end	Order No.	Order No.	Order No.	Order No.	Order No.	Order No.	Order No.	
	Variable 1511491	2 m 1518025 5 m 1518038 10 m 1518041 15 m 1518054	Variable 1538050	Variable 1433236	2 m 1507243 5 m 1507256 10 m 1507269 15 m 1507272	Variable 1538047		
M12-SPEEDCON socket, straight 		0.3 m 1518106 0.5 m 1518119 1 m 1518122 2 m 1518135 5 m 1518148 10 m 1518151 15 m 1518164	Variable 1538076	Variable 1538092	Variable 1433265			
M12-SPEEDCON socket, angled 	Variable 1433249	Variable 1433252	Variable 1433278					
M12 socket, straight 		2 m 1507298 5 m 1507308 10 m 1507311 15 m 1507324			0.3 m 1507340 0.5 m 1507353 1 m 1507366 2 m 1507379 5 m 1507382 10 m 1507395 15 m 1507405	Variable 1538063	Variable 1538089	

Ordering example for cable with connector assembly:

For a PROFIBUS bus cable, straight M12 socket to a straight M12 connector and the cable length of 34.5 m, the order data is as follows:

Order No.	Length [m] Max. 40 m
1538089	34.5
	Increments: 0.2 ... 3.0 m = 0.1 m > 3.0 m = 0.5 m

Ordering example for cable without connector assembly:

For a PROFIBUS bus cable with a cable length of 34.5 m, the order data is as follows:

Order No.	Length [m] Max. 400 m
1511491	34.5
	Increments: 0.5 ... 400.0 m = 0.5 m

Technical data

		M12
Rated voltage	[V]	250
Rated current	[A]	4
Contact resistance		≤ 5 mΩ
Contact material		CuSn
Contact surface material		Ni/Au
Material of grip body		TPU, hardly inflammable, self-extinguishing
Degree of protection		IP65 / IP67
Temperature data		
Plug/socket	[°C]	-25 ... 90

Data connectors and cables

Fieldbus components - assembled cables

Assembled cables, PROFIBUS PA, M12 stainless steel

Notes:
For information about the cable qualities, see page 442

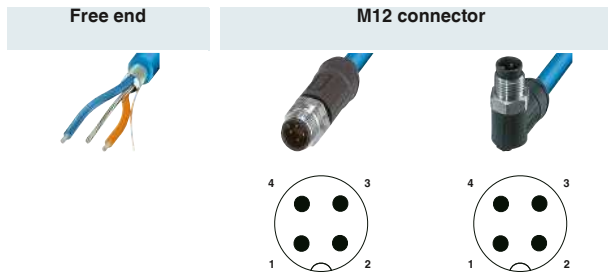

Free end	Ordering data		Ordering data		Ordering data	
	Order No.		Order No.		Order No.	
		2 m	1419092	2 m	1419097	
		5 m	1419093	5 m	1419098	
		10 m	1419094	10 m	1419099	
		15 m	1419095	15 m	1419100	
		20 m	1419096	20 m	1419101	
M12 socket, straight 		0.3 m	1419102	0.3 m	1419110	
		0.5 m	1419103	0.5 m	1419111	
		1 m	1419104	1 m	1419112	
		2 m	1419105	2 m	1419113	
		5 m	1419106	5 m	1419114	
M12 socket, angled 		0.3 m	1419118	0.3 m	1419126	
		0.5 m	1419119	0.5 m	1419127	
		1 m	1419120	1 m	1419128	
		2 m	1419121	2 m	1419129	
		5 m	1419122	5 m	1419130	
	10 m	1419123	10 m	1419131		
	15 m	1419124	15 m	1419132		
	20 m	1419125	20 m	1419133		

Color coding	Pin assignment M12
OG	1
n.c.	2
BU	3
Shield	4

		Technical data
		M12
Rated voltage	[V]	60
Rated current	[A]	4
Contact resistance		≤ 5 mΩ
Contact material		CuSn
Contact surface material		Ni/Au
Material of grip body		TPU, hardly inflammable, self-extinguishing
Degree of protection		IP65 / IP67 / IP68 / IP69K
Temperature data		
Plug/socket	[°C]	-25 ... 90

**Assembled cables,
DeviceNet™/CANopen®,
M12-SPEEDCON**

Notes:
For information about the cable qualities, see page 441
Connector, unshielded.

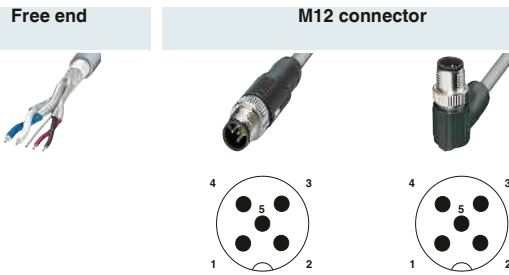

Free end	Ordering data		Ordering data		Ordering data	
	Order No.	Order No.	Order No.	Order No.	Order No.	Order No.
		2 m	1419039	2 m	1419044	
		5 m	1419040	5 m	1419045	
		10 m	1419041	10 m	1419046	
		15 m	1419042	15 m	1419047	
		20 m	1419043	20 m	1419048	
M12 socket, straight 		0.3 m	1419049	0.3 m	1419057	
		0.5 m	1419050	0.5 m	1419058	
		1 m	1419051	1 m	1419059	
	2 m	1419081	2 m	1419052	2 m	1419060
	5 m	1419030	5 m	1419053	5 m	1419061
	10 m	1419031	10 m	1419054	10 m	1419062
15 m	1419032	15 m	1419055	15 m	1419063	
20 m	1419033	20 m	1419056	20 m	1419064	
M12 socket, angled 		0.3 m	1419065	0.3 m	1419073	
		0.5 m	1419066	0.5 m	1419074	
		1 m	1419067	1 m	1419075	
	2 m	1419034	2 m	1419068	2 m	1419076
	5 m	1419035	5 m	1419069	5 m	1419077
	10 m	1419036	10 m	1419070	10 m	1419078
	15 m	1419037	15 m	1419071	15 m	1419079
	20 m	1419038	20 m	1419072	20 m	1419080

Color coding	Pin assignment
	M12
Shield	1
RD	2
BK	3
WH	4
BU	5

		Technical data
		M12
Rated voltage	[V]	60
Rated current	[A]	4
Contact resistance		< 5 mΩ
Contact material		CuSn
Contact surface material		Ni/Au
Material of grip body		TPU
Degree of protection		IP65 / IP67
Temperature data		
Plug/socket	[°C]	-25 ... 90

Fieldbus components - assembled cables

Assembled cables, DeviceNet™/CANopen®, M8

Notes:





For information about the cable qualities, see page 441

Free end



M8 connector



	Ordering data		Ordering data		Ordering data	
Free end	Order No.		Order No.		Order No.	
			2 m		1575712	
			5 m		1575725	
			10 m		1575738	
			15 m		1575754	
			Variable		1575767	Variable
M8 socket, straight  			0.3 m		1575822	
			0.5 m		1575835	
			1 m		1575848	
	2 m	1575770	2 m		1575851	
	5 m	1575783	5 m		1575864	
	10 m	1575796	10 m		1575877	
	15 m	1575806	15 m		1575880	
Variable	1575819	Variable		1575893	Variable	1575932
M8 socket, angled  						
	Variable	1575916	Variable		1575945	Variable

Ordering example for cables with variable cable length:

For a DeviceNet™ bus cable, straight M8 socket to a straight M8 connector and a cable length of 34.5 m, the order data is as follows:

Order No.	Length [m] Max. 40 m
1575893	34.5
	Increments: 0.2 ... 3.0 m = 0.1 m > 3.0 m = 0.5 m

Technical data

		M8
Rated voltage	[V]	30
Rated current	[A]	4
Contact resistance		≤ 5 mΩ
Contact material		CuSn
Contact surface material		Ni/Au
Material of grip body		TPU, hardly inflammable, self-extinguishing
Degree of protection		IP65 / IP67
Temperature data		
Plug/socket	[°C]	-25 ... 90

Assembled cables, DeviceNet™/CANopen®, M12-SPEEDCON and M12

Notes:
For information about the cable qualities, see page 441



	Ordering data		Ordering data		Ordering data		Ordering data	
Free end	Order No.	Order No.	Order No.	Order No.	Order No.	Order No.	Order No.	
	Variable 1511504	2 m 1518177 5 m 1518180 10 m 1518193 15 m 1518203	Variable 1538115	Variable 1433281	2 m 1507421 5 m 1507434 10 m 1507447 15 m 1507450	Variable 1538102		
M12 socket, SPEEDCON, straight 		0.3 m 1518258 0.5 m 1518261 1 m 1518274 2 m 1518287 5 m 1518290 10 m 1518300 15 m 1518313						
	2 m 1518216 5 m 1518229 10 m 1518232 15 m 1518245	Variable 1538131	Variable 1538157	Variable 1433317				
M12 socket, SPEEDCON, angled 								
			Variable 1433294	Variable 1433304	Variable 1433320			
M12 socket, straight 						0.3 m 1507528 0.5 m 1507531 1 m 1507544 2 m 1507557 5 m 1507560 10 m 1507573 15 m 1507586	Variable 1538128 Variable 1538144	
	2 m 1507476 5 m 1507489 10 m 1507492 15 m 1507502							

Ordering example for cable with connector assembly:

For a DeviceNet™ bus cable, straight M12 socket to a straight M12 connector and the cable length of 34.5 m, the order data is as follows:

Order No.	Length [m] Max. 40 m
1538144	34.5
	Increments: 0.2 ... 3.0 m = 0.1 m > 3.0 m = 0.5 m

Ordering example for cable without connector assembly:

For a DeviceNet™ bus cable with a cable length of 34.5 m, the order data is as follows:

Order No.	Length [m] Max. 400 m
1511504	34.5
	Increments: 0.5 ... 400.0 m = 0.5 m

Technical data	
M12	
Rated voltage	[V] 60
Rated current	[A] 4
Contact resistance	≤ 5 mΩ
Contact material	CuSn
Contact surface material	Ni/Au
Material of grip body	TPU, hardly inflammable, self-extinguishing
Degree of protection	IP65 / IP67
Temperature data	
Plug/socket	[°C] -25 ... 90

Data connectors and cables

Fieldbus components - assembled cables

Assembled drop cable, DeviceNet™, 7/8", type 923

Notes:

For information about the cable qualities, see page 441





Free end



7/8" connector



DeviceNet

Free end	Ordering data		Ordering data		Ordering data	
	Order No.		Order No.		Order No.	
		2 m	1418523	2 m	1418578	
		5 m	1418536	5 m	1418581	
		10 m	1418549	10 m	1418594	
		15 m	1418552	15 m	1418604	
		20 m	1418565	20 m	1418617	
7/8" socket, straight  		0.3 m	1418620	0.3 m	1418701	
		0.5 m	1418633	0.5 m	1418714	
		1 m	1418646	1 m	1418727	
	2 m	1418426	2 m	1418659	2 m	1418730
	5 m	1418439	5 m	1418662	5 m	1418743
	10 m	1418442	10 m	1418675	10 m	1418756
15 m	1418455	15 m	1418688	15 m	1418769	
20 m	1418468	20 m	1418691	20 m	1418772	
7/8" socket, angled  		0.3 m	1418785	0.3 m	1420045	
		0.5 m	1418798	0.5 m	1420058	
		1 m	1418808	1 m	1420061	
	2 m	1418471	2 m	1418811	2 m	1420074
	5 m	1418484	5 m	1418824	5 m	1420087
	10 m	1418497	10 m	1418837	10 m	1420090
	15 m	1418507	15 m	1420029	15 m	1420100
	20 m	1418510	20 m	1420032	20 m	1420113

Color coding	Pin assignment 7/8"
Shield	1
RD	2
BK	3
WH	4
BU	5

		Technical data
		7/8"
Rated voltage	[V]	30
Rated current	[A]	5.2
Contact resistance		< 5 mΩ
Contact material		CuZn
Contact surface material		Au
Material of grip body		TPU
Degree of protection		IP65 / IP67
Temperature data		
Plug/socket	[°C]	-40 ... 80

**Assembled trunk cable,
DeviceNet™, 7/8", type 928**

Free end

7/8" connector



Notes:

For information about the cable qualities, see page 441

DeviceNet

Ordering data Ordering data Ordering data

Free end	Order No.	Order No.	Order No.
	2 m	1417553	2 m 1417605
	5 m	1417566	5 m 1417618
	10 m	1417579	10 m 1417621
	15 m	1417582	15 m 1417634
	20 m	1417595	20 m 1417647

7/8" socket, straight



0.3 m	1417650	0.3 m 1417731
0.5 m	1417663	0.5 m 1417744
1 m	1417676	1 m 1417757
2 m	1417689	2 m 1417760
5 m	1417692	5 m 1417773
10 m	1417702	10 m 1417786
15 m	1417715	15 m 1417799
20 m	1417728	20 m 1418009

7/8" socket, angled



0.3 m	1417812	0.3 m 1417896
0.5 m	1417825	0.5 m 1417906
1 m	1417838	1 m 1417919
2 m	1417841	2 m 1417922
5 m	1417854	5 m 1417935
10 m	1417867	10 m 1417948
15 m	1417870	15 m 1417951
20 m	1417883	20 m 1417964

Color coding

**Pin assignment
7/8"**

Shield		1
RD		2
BK		3
WH		4
BU		5

Technical data

		7/8"
Rated voltage	[V]	30
Rated current	[A]	5.2
Contact resistance		< 5 mΩ
Contact material		CuZn
Contact surface material		Au
Material of grip body		TPU
Degree of protection		IP65 / IP67
Temperature data		
Plug/socket	[°C]	-40 ... 80

M12 Y distributor

Notes:
For information about the cable qualities, see page 441
Connector, unshielded.

DeviceNet
CANopen



Bus system cable

DeviceNet
CANopen



Bus system cable

ERC

Technical data

Electrical data	
Rated voltage	60 V
Rated current	4 A
Contact resistance	≤ 5 mΩ
Material data	
Contact material	CuSn
Contact surface material	Ni/Au
Contact carrier material	TPU GF
Inflammability class according to UL 94	HB
Mechanical data	
No. of pos.	5
Pollution degree	3
Degree of protection	IP65/IP67
External cable diameter	6.70 mm
Conductor cross section for signal	0.2 mm ²
Conductor structure signal line	19x 0.12 mm
Conductor cross section for power	0.32 mm ²
Conductor structure, voltage supply	19x 0.15 mm
Temperature data	
Plug/socket	[°C] -25 ... 90
Cable, fixed installation	[°C] -40 ... 80
Cable, flexible installation	[°C] -20 ... 70

ERC

Technical data

Electrical data	
Rated voltage	60 V
Rated current	4 A
Contact resistance	≤ 5 mΩ
Material data	
Contact material	CuSn
Contact surface material	Ni/Au
Contact carrier material	-
Inflammability class according to UL 94	HB
Mechanical data	
No. of pos.	5
Pollution degree	3
Degree of protection	IP65/IP67
External cable diameter	6.70 mm
Conductor cross section for signal	0.2 mm ²
Conductor structure signal line	19x 0.12 mm
Conductor cross section for power	0.32 mm ²
Conductor structure, voltage supply	19x 0.15 mm
Temperature data	
Plug/socket	[°C] -25 ... 90
Cable, fixed installation	[°C] -40 ... 80
Cable, flexible installation	[°C] -20 ... 70

Ordering data

Description
Bus system Y-cable , 5-pos., shielded, PUR, halogen-free, violet, unshielded straight M12 Y-socket to straight M12 socket and straight M12 connector
- Conductor length 0.3 m
- Conductor length 0.5 m
- Conductor length 1.0 m
- Conductor length 2.0 m
- Conductor length 5.0 m
- Conductor length 10.0 m
- Conductor length 15.0 m
Bus system Y-cable , 5-pos., shielded, PUR, halogen-free, violet, unshielded straight M12 Y-connector to free cable ends
- Conductor length 2.0 m
- Conductor length 5.0 m
- Conductor length 10.0 m
- Conductor length 15.0 m
Bus system Y-cable , 5-pos., shielded, PUR, halogen-free, violet, unshielded straight M12 Y-socket to free cable ends
- Conductor length 2.0 m
- Conductor length 5.0 m
- Conductor length 10.0 m
- Conductor length 15.0 m

Type	Order No.	Pcs. / Pkt.
SAC-5PY-F/2X 0,3-920-MS-FS	1436013	1
SAC-5PY-F/2X 0,5-920-MS-FS	1436026	1
SAC-5PY-F/2X 1,0-920-MS-FS	1436039	1
SAC-5PY-F/2X 2,0-920-MS-FS	1436042	1
SAC-5PY-F/2X 5,0-920-MS-FS	1436055	1
SAC-5PY-F/2X10,0-920-MS-FS	1436068	1
SAC-5PY-F/2X15,0-920-MS-FS	1436071	1

Ordering data

Type	Order No.	Pcs. / Pkt.
SAC-5PY-M/2X 2,0-920	1436084	1
SAC-5PY-M/2X 5,0-920	1436097	1
SAC-5PY-M/2X10,0-920	1436107	1
SAC-5PY-M/2X15,0-920	1436110	1
SAC-5PY-F/2X 2,0-920	1436123	1
SAC-5PY-F/2X 5,0-920	1436136	1
SAC-5PY-F/2X10,0-920	1436149	1
SAC-5PY-F/2X15,0-920	1436152	1

Assembled cables, FOUNDATION Fieldbus, 7/8"

Notes:
 For applications in circuits of the intrinsic safety "i" protection type.
 For information about the cable qualities, see page 442



Free end

7/8" plug

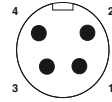
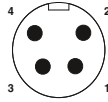

Ordering data

Free end	Order No.	Order No.	Order No.
	Variable 1434620	2 m 1433964	2 m 1434057
		5 m 1433977	5 m 1434060
		10 m 1433980	10 m 1434073
7/8" socket, straight 		0.3 m 1434141	0.3 m 1434264
		0.5 m 1434154	0.5 m 1434277
		1 m 1434167	1 m 1434280
		2 m 1433786	2 m 1434293
		5 m 1433799	5 m 1434303
		10 m 1433809	10 m 1434316
7/8" socket, angled 		0.3 m 1434387	0.3 m 1434507
		0.5 m 1434390	0.5 m 1434510
		1 m 1434400	1 m 1434523
		2 m 1433870	2 m 1434536
		5 m 1433883	5 m 1434549
		10 m 1433896	10 m 1434552

Ordering example for products with variable cable:

For a FOUNDATION Fieldbus cable that is 34.5 m in length, the ordering data is as follows:

Order No.	Length [m] max. 50 m
1434620	34.5
	Increment: 0.5 m



Color coding	Pin assignment	
	7/8"	M12
BU	1	1
BN	2	2
Shield	3	3
n.c.	4	4

Technical data

		7/8"
Rated voltage	[V]	300
Rated current	[A]	5.2
Contact resistance		≤ 5 mΩ
Contact material		CuZn
Contact surface material		AU
Material of grip body		TPU
Degree of protection		IP67
Temperature data		
Plug/socket	[°C]	-40 ... 105

Data connectors and cables

Fieldbus components - assembled cables

Assembled cables, FOUNDATION Fieldbus, 7/8" and M12 stainless steel

Notes:
For information about the cable qualities, see page 442

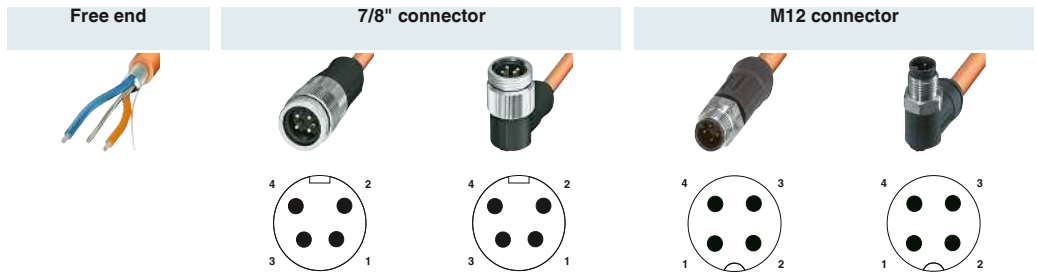

	Ordering data		Ordering data		Ordering data		Ordering data		Ordering data	
Free end	Order No.		Order No.		Order No.		Order No.		Order No.	
			2 m	1429350	2 m	1429444	2 m	1431173		
			5 m	1429363	5 m	1429457	5 m	1431186		
			10 m	1429376	10 m	1429460	10 m	1431199		
			15 m	1429389	15 m	1429473	15 m	1431209		
			20 m	1429392	20 m	1429486				
			25 m	1429402	25 m	1429499				
			30 m	1429415	30 m	1429509				
			40 m	1429428	40 m	1429512				
			50 m	1429431	50 m	1429525				
	Variable	1432389					Variable	1431322	Variable	1431335
7/8" socket, straight			0.3 m	1429538	0.3 m	1429664				
			0.5 m	1429554	0.5 m	1429677				
			1 m	1429567	1 m	1429680				
			2 m	1429570	2 m	1429693				
			5 m	1429583	5 m	1429703				
			10 m	1429198	10 m	1429716				
			15 m	1429208	15 m	1429729				
			20 m	1429211	20 m	1429732				
			25 m	1429224	25 m	1429745				
			30 m	1429237	30 m	1429758				
			40 m	1429240	40 m	1429761				
			50 m	1429253	50 m	1429774				
			0.3 m	1429787	0.3 m	1429907				
			0.5 m	1429790	0.5 m	1429910				
			1 m	1429800	1 m	1429923				
			2 m	1429813	2 m	1429936				
			5 m	1429826	5 m	1429949				
			10 m	1429839	10 m	1429952				
			15 m	1429842	15 m	1429965				
			20 m	1429305	20 m	1429978				
			25 m	1429318	25 m	1429981				
			30 m	1429321	30 m	1429994				
			40 m	1429334	40 m	1430006				
			50 m	1429347	50 m	1430019				
			0.3 m	1431254	0.3 m	1431254				
			0.5 m	1431267	0.5 m	1431267				
			1 m	1431270	1 m	1431270				
			2 m	1431283	2 m	1431283				
			5 m	1431296	5 m	1431296				
			10 m	1431306	10 m	1431306				
			15 m	1431319	15 m	1431319				
	Variable	1431348					Variable	1431364	Variable	1431377
M12 socket, angled			Variable	1431351			Variable	1431380	Variable	1431393

Ordering example for products with variable cable:

For a FOUNDATION Fieldbus cable, fitted with a straight M12 connector at one end and an M12 socket at the other end, and 34.5 m in length, the ordering data is as follows:

Order No.	Length [m] max. 50 m
1431364	34.5
	Increment: 0.5 m

Color coding	Pin assignment	
	7/8"	M12
BU	1	1
BN	2	2
Shield	3	3
n.c.	4	4

	Technical data	
	7/8"	Connectors M12
Rated voltage [V]	300	250
Rated current [A]	5.2	4
Contact resistance	≤ 5 mΩ	≤ 5 mΩ
Contact material	CuZn	CuSn
Contact surface material	AU	Ni/Au
Material of grip body	TPU	TPU, hardly inflammable, self-extinguishing
Material, knurls	Stainless steel	Stainless steel
Degree of protection	IP67	IP65 / IP67 / IP68 / IP69K
Temperature data		
Plug/socket [°C]	-40 ... 105	-25 ... 90

H- and T-distributors



H-distributor



T-distributor

ERC

ERC

Technical data	
Electrical data	SAC-5PH-M-F/2XF SH1 SCO
Nominal voltage U_N	60 V
Insulation resistance	$\geq 100 \text{ M}\Omega$
Surge voltage category/pollution degree	II / 3
Material data	
Contact material	CuZn
Contact surface material	Ni/Au
Contact carrier material	TPU GF
Material of grip body	TPU, hardly inflammable, self-extinguishing
Degree of protection	IP65/IP67
Temperature data	
Plug/socket	-25 ... 90 [°C]

Technical data	
SAC-5P-M12T/2XMIN DN	SAC-5P-M12T/2XM12 VP
60 V	60 V
$\geq 100 \text{ M}\Omega$	$\geq 100 \text{ M}\Omega$
II / 3	II / 3
Material data	
Contact material	CuZn
Contact surface material	Ni/Au
Contact carrier material	TPU GF
Material of grip body	TPU, hardly inflammable, self-extinguishing
Degree of protection	IP65/IP67
Temperature data	
Plug/socket	-40 ... 75 -25 ... 90

Ordering data			
Description	Type	Order No.	Pcs. / Pkt.
Bus system H-distributor , for DeviceNet™ with two mounting holes M12 connector to 3x M12 sockets	SAC-5PH-M-F/2XF SH1 SCO	1417414	1
Bus system T-distributor , for DeviceNet™ , with stainless steel knurl and two mounting holes M12 socket to 7/8" connector and 7/8" socket 7/8" socket to 7/8" connector and 7/8" socket			
Bus system T-distributor , for CANopen® and DeviceNet™ , M12 socket to M12 socket and M12 connector			
Green Black, with two mounting holes Bus system T-distributor , for CC-Link M12 socket to M12 socket and M12 connector			
Bus system T-distributor , for FOUNDATION Fieldbus and PROFIBUS PA (M12), with stainless steel knurl M12 socket to M12 socket and M12 connector			
7/8" socket to 7/8" connector and 7/8" socket, with two mounting holes Bus system T-distributor , for PROFIBUS M12 socket to M12 connector and M12 socket, with two mounting holes			

Ordering data		
Type	Order No.	Pcs. / Pkt.
SAC-5P-M12T/2XMIN DN	1401028	1
SAC-5P-MINT/2XMIN DN	1401029	1
SAC-5P-M12T/2XM12 VP	1541186	1
SAC-M12T/2XM12 CAN	1507793	1
SAC-4P-M12T/2XM12 CCL	1559783	5
SAC-4P-M12T/2XM12 FF VA	1431416	5
SAC-4P-MIN-T/2XMIN FF VA	1430035	1
SAC-M12T/2XM12 PBDP	1458884	1

Termination resistors



M8/M12 termination resistors



7/8" termination resistors

ERIC

ERIC

	Technical data			Technical data		
	SAC-5P-M12MS PB TR	SAC-4P-M12MS FF TR VA		SAC-4P-MINMS FF-TR VA		
Electrical data						
Nominal voltage U_N	60 V	24 V		50 V		
Insulation resistance	$\geq 100 \text{ M}\Omega$	$\geq 100 \text{ M}\Omega$		$\geq 10 \text{ M}\Omega$		
Surge voltage category/pollution degree	II / 3	II / 3		II / 2		
Material data						
Contact material	CuSn	CuZn		CuZn		
Contact surface material	Ni/Au	Ni/Au		AU		
Contact carrier material	TPU GF	TPU GF		PA 66		
Material of grip body	TPU, hardly inflammable, self-extinguishing	TPU, hardly inflammable, self-extinguishing		TPU		
Degree of protection	IP65/IP67/IP69K	IP65/IP68/IP69K		IP67		
Temperature data						
Plug/socket	-25 ... 90	-25 ... 90		-40 ... 80		
	Ordering data			Ordering data		
Description	Type	Order No.	Pcs. / Pkt.	Type	Order No.	Pcs. / Pkt.
Termination resistor , M8 connector - DeviceNet™	SAC-5P-M 8MS DN TR	1435988	5			
Termination resistor , M12 connector - PROFIBUS	SAC-5P-M12MS PB TR	1507803	5			
- DeviceNet™/CANopen®	SAC-5P-M12MS CAN TR	1507816	5			
- CC-Link	SAC-4P-M12MS CCL TR	1558470	1			
Termination resistor , M12 connector, stainless steel knurl						
- FOUNDATION Fieldbus	SAC-4P-M12MS FF TR VA	1431403	5			
Termination resistor , 7/8" connector, stainless steel knurl						
- FOUNDATION Fieldbus				SAC-4P-MINMS FF-TR VA	1430023	1
Termination resistor , 7/8" connector - DeviceNet™				SAC-5P-MINMS TR-DN	1434701	1

Fieldbus components - AS-Interface

Flat-ribbon conductors, flat-ribbon conductor connectors, and panel feed-throughs



Flat-ribbon conductors and accessories



Flat-ribbon conductors and panel feed-throughs with QUICKON fast connection technology



		Technical data			Technical data		
		VS-ASI-FC-PVC...	VS-ASI-FC-PUR...	Q 1,5/4IDC	Q 1,5/4M20		
Mechanical data							
No. of pos.		2	2	4	4		
Degree of protection		-	-	IP65/IP67	IP65/IP67		
Cable data							
Outer sheath material		PVC	PUR	-	-		
Conductor cross section		1.5 mm ²	1.5 mm ²	-	-		
Connector data QUICKON connection				0.75 mm ² ... 1.5 mm ²	0.75 mm ² ... 1.5 mm ²		
Conductor cross section [mm ²]		-	-	18 ... 16	18 ... 16		
Conductor cross section [AWG]		-	-	-	-		
Temperature data							
Plug/socket		[°C]	-	-25 ... 80	-25 ... 80		
Cable, fixed installation		[°C]	-30 ... 90	-	-		
Cable, flexible installation		[°C]	-20 ... 90	-30 ... 85	-		
		Ordering data			Ordering data		
Description	Cable length	Type	Order No.	Pcs. / Pkt.	Type	Order No.	Pcs. / Pkt.
AS-Interface EPDM flat-ribbon conductor, 2 x 1.5 mm²							
Yellow	100 m	VS-ASI-FC-EPDM-YE 100M	1432402	1			
Yellow	1000 m	VS-ASI-FC-EPDM-YE 1000M	1434646	1			
Black	100 m	VS-ASI-FC-EPDM-BK 100M	1432415	1			
Black	1000 m	VS-ASI-FC-EPDM-BK 1000M	1434659	1			
AS-Interface PVC flat-ribbon conductor to UL, 2 x 1.5 mm²							
Yellow	100 m	VS-ASI-FC-PVC-UL-YE 100M	1404906	1			
Yellow	1000 m	VS-ASI-FC-PVC-UL-YE/1000	1404867	1			
Black	100 m	VS-ASI-FC-PVC-UL-BK 100M	1404919	1			
Black	1000 m	VS-ASI-FC-PVC-UL-BK/1000	1404870	1			
AS-Interface TPE flat-ribbon conductor to UL, 2 x 1.5 mm²							
Yellow	100 m	VS-ASI-FC-TPE-UL-YE 100M	1404922	1			
Yellow	1000 m	VS-ASI-FC-TPE-UL-YE 1000M	1434662	1			
Black	100 m	VS-ASI-FC-TPE-UL-BK 100M	1404935	1			
Black	1000 m	VS-ASI-FC-TPE-UL-BK 1000M	1434675	1			
AS-Interface PUR flat-ribbon conductor, 2 x 1.5 mm²							
Yellow	100 m	VS-ASI-FC-PUR-YE 100M	1404883	1			
Yellow	1000 m	VS-ASI-FC-PUR-YE/1000	1404841	1			
Black	100 m	VS-ASI-FC-PUR-BK 100M	1404896	1			
Black	1000 m	VS-ASI-FC-PUR-BK/1000	1404854	1			
Flat connector, 4-pos., for connecting one or two AS-i flat-ribbon conductors							
Panel feed-through, for accommodating one or two AS-i flat-ribbon conductors, on the rear side with manual solder/slip-on connection 4.8 x 0.8 mm					Q 1,5/4IDC/24-24KU-KU-ASI-BK	1585058	1
Panel feed-through, for accommodating one or two AS-Interface flat-ribbon conductors, on the rear side with four individual 1.5 mm² wires					Q 1,5/4FL/24-M20KU-ESA-ASI BK	1437261	1
Metal gland, for AS-Interface flat-ribbon conductor					Q 1,5/4A50/24-M20KU-ESA-ASI BK	1437274	1
Thread type: M20					HC-M-KV-M20(1ASI)	1584017	10
Thread type: M25					HC-M-KV-M25(1ASI)	1584020	10

Distributor with spring connection and with round conductors



Flat-ribbon conductor distributors and distributors with spring connection



Distributor with round cable and molded M12 connector with SPEEDCON

	Technical data		Technical data	
	SAC-ASI-J-Y-B-FFKDS	SAC-ASI-J-Y-Y-N	SAC-ASI-J-Y-N...	SAC-ASI-J-Y-B...
Electrical data				
Rated voltage	≤ 35 V	≤ 32 V	≤ 32 V	≤ 32 V
Rated current	≤ 6 A	≤ 8 A	≤ 4 A	≤ 4 A
Material specifications for exit				
Material of grip body	-	-	TPU	TPU
Material specifications for distributor				
Housing material	PBT	PBT	PBT	PBT
Mechanical data				
No. of pos.	4	4	2	4
Degree of protection	IP20	IP65/IP67	IP65/IP67	IP65/IP67
Connection data for spring-cage terminal blocks				
Conductor cross section	0.2 mm ² ... 1.5 mm ²	-	-	-
Connection cross section AWG	24 ... 16	-	-	-
Cable data				
Outer sheath material	-	-	PUR	PUR
External cable diameter	-	-	4.30 mm	4.30 mm
Conductor cross section	-	-	4x 0.34 mm ² (signal line)	4x 0.34 mm ² (signal line)
Temperature data				
Plug/socket	[°C] -25 ... 75	-25 ... 75	-25 ... 75	-25 ... 75
Cable, fixed installation	[°C] -	-	-40 ... 80	-40 ... 80
Cable, flexible installation	[°C] -	-	-25 ... 80	-25 ... 80

Description	Cable length	Ordering data			Ordering data		
		Type	Order No.	Pcs. / Pkt.	Type	Order No.	Pcs. / Pkt.
AS-Interface distributor with IP20 degree of protection for two flat conductors , 4-pos., with spring-cage terminal blocks		SAC-ASI-J-Y-B-FFKDS	1407579	1			
AS-Interface H-distributor with high degree of protection, parallel wired , for distribution from one to two flat-ribbon conductors		SAC-ASI-J-Y-Y-N	1405622	1			
AS-Interface distributor for 1 flat-ribbon conductor, with PUR round cable and molded, straight , A-coded, 2-pos. M12 socket with SPEEDCON	1 m 2 m				SAC-ASI-J-Y-N-PUR-1,0-FS SCO SAC-ASI-J-Y-N-PUR-2,0-FS SCO	1407573 1407574	1 1
AS-Interface distributor for 2 flat-ribbon conductors, with PUR round cable and molded, straight , A-coded, 4-pos. M12 socket with SPEEDCON	1 m 2 m				SAC-ASI-J-Y-B-PUR-1,0-FS SCO SAC-ASI-J-Y-B-PUR-2,0-FS SCO	1407575 1407576	1 1
AS-Interface distributor for 2 flat-ribbon conductors, with PUR round cable and molded, angled , A-coded, 4-pos. M12 socket with SPEEDCON	1 m 2 m				SAC-ASI-J-Y-B-PUR-1,0-FR SCO SAC-ASI-J-Y-B-PUR-2,0-FR SCO	1407577 1407578	1 1
AS-Interface distributor for 1 flat-ribbon conductor, with 2.0 m PUR round cable and open cable end	2 m				SAC-ASI-J-Y-N-PUR-2,0-OE	1407580	1
AS-Interface distributor for 2 flat-ribbon conductors, with 2.0 m PUR round cable and open cable end	2 m				SAC-ASI-J-Y-B-PUR-2,0-OE	1407581	1

Distributors with M12-socket, with screw connection, pre-assembled round cable



Distributors with M12 slot and with screw connection



PUR round conductors with molded M12-SPEEDCON connectors



	Technical data		Technical data	
Material data	SAC-ASI-J-Y-N-M12FS	VS-ASI-J-Y-N-SWA-LC	-	-
Housing material	PBT	PA	-	-
Material of grip body	-	-	TPU, hardly inflammable, self-extinguishing	-
No. of pos.	2	2	4	-
Degree of protection	IP65/IP67	IP67	IP65/IP67	-
Connection data for screw connection				
Conductor cross section	-	0.14 mm ² ... 1 mm ² (solid)	-	-
Connection cross section AWG	-	26 ... 17 (solid)	-	-
Conductor cross section	-	0.14 mm ² ... 0.75 mm ² (With ferrules)	-	-
Connection cross section AWG	-	26 ... 18 (With ferrules)	-	-
Cable data				
Conductor cross section	-	-	0.75 mm ²	-
Temperature data				
Plug/socket	[°C] -25 ... 75	[°C] -25 ... 70	[°C] -25 ... 90	-
Cable, fixed installation	[°C] -	[°C] -	[°C] -25 ... 80	-
Cable, flexible installation	[°C] -	[°C] -	[°C] -5 ... 80	-

		Ordering data			Ordering data		
Description	Cable length	Type	Order No.	Pcs. / Pkt.	Type	Order No.	Pcs. / Pkt.
AS-Interface distributor for flat-ribbon conductors, with straight, A-coded M12 socket							
One flat conductor, 2-pos.		SAC-ASI-J-Y-N-M12FS	1405619	1			
Two flat conductors, 4-pos.		SAC-ASI-J-Y-B-M12FS	1405621	1			
AS-Interface distributor , with straight, A-coded M12 socket							
One flat conductor, 2-pos.		VS-ASI-J-Y-N-M12FS-LC	1433155	1			
AS-Interface distributor , with screw connection, angled							
One flat conductor, 2-pos.		VS-ASI-J-Y-N-SWA-LC	1433168	1			
Pre-assembled round conductor							
M12 pin, straight, free conductor end	2 m				SAC-4P-MS/ 2,0-186 SCO	1555606	1
	5 m				SAC-4P-MS/ 5,0-186 SCO	1555619	1
	10 m				SAC-4P-MS/10,0-186 SCO	1555622	1
	15 m				SAC-4P-MS/15,0-186 SCO	1555635	1
Pre-assembled round conductor							
M12 socket, straight, free conductor end	2 m				SAC-4P- 2,0-186/FS SCO	1555648	1
	5 m				SAC-4P- 5,0-186/FS SCO	1555651	1
	10 m				SAC-4P-10,0-186/FS SCO	1555664	1
	15 m				SAC-4P-15,0-186/FS SCO	1555677	1
Pre-assembled round conductor							
M12 pin, straight, M12 socket, straight	0.3 m				SAC-4P-MS/ 0,3-186/FS SCO	1555680	1
	0.5 m				SAC-4P-MS/ 0,5-186/FS SCO	1555693	1
	1 m				SAC-4P-MS/ 1,0-186/FS SCO	1555703	1
	2 m				SAC-4P-MS/ 2,0-186/FS SCO	1555716	1
	5 m				SAC-4P-MS/ 5,0-186/FS SCO	1555729	1
	10 m				SAC-4P-MS/10,0-186/FS SCO	1555732	1
	15 m				SAC-4P-MS/15,0-186/FS SCO	1555745	1

Digital I/O devices with M8 connection method

The digital I/O devices are particularly suitable for use in machines close to the process.

Features:

- Optimized for 30 mm mounting profile
- M12 connection method with SPEEDCON fast locking system for the AS-Interface connection
- M8 connection method for the I/Os



4 digital inputs



4 digital inputs and 4 digital outputs

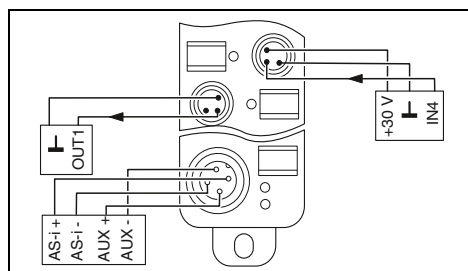
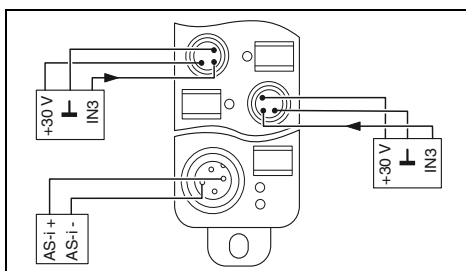

Technical data

Interface	
Fieldbus system	AS-i
Connection method	M12 connector, (A-coded)
AS-Interface	
AS-i specification	2.0
Required master specification	>= 2.0
AS-i profile	S-0.0
Digital inputs	
Connection method	M8 connector
Connection technology	2, 3-wire
Maximum number of inputs	-
Input characteristic curve	IEC 61131-2 type 2
Digital outputs	
Connection method	-
Connection technology	-
Maximum number of outputs	-
Maximum output current per channel	-
Maximum output current per module/terminal block	-
General data	
Weight	85 g
Drill hole spacing	93 mm
Dimensions	W / H / D 30 mm / 26 mm / 103 mm
Degree of protection	IP65/IP67
Ambient temperature (operation)	-25 °C ... 70 °C
EMC note	Class A product, see page 730

Technical data

Interface	
Fieldbus system	AS-i
Connection method	M12 connector, (A-coded)
AS-Interface	
AS-i specification	2.0
Required master specification	>= 2.0
AS-i profile	S-7.0
Digital inputs	
Connection method	M8 connector
Connection technology	2, 3-wire
Maximum number of inputs	-
Input characteristic curve	IEC 61131-2 type 2
Digital outputs	
Connection method	M8 connector
Connection technology	2-wire
Maximum number of outputs	-
Maximum output current per channel	1 A
Maximum output current per module/terminal block	4 A
General data	
Weight	125 g
Drill hole spacing	133 mm
Dimensions	W / H / D 30 mm / 26 mm / 143 mm
Degree of protection	IP65/IP67
Ambient temperature (operation)	-25 °C ... 70 °C
EMC note	Class A product, see page 730

Ordering data

Description	
Fieldline Extension AS-i digital input device	
- 4 inputs	
Fieldline Extension AS-i digital I/O device	
- 4 inputs, 4 outputs, 1 A	

Type	Order No.	Pcs. / Pkt.
FLX ASI DI 4 M8	2773403	1

Ordering data

Type	Order No.	Pcs. / Pkt.
FLX ASI DIO 4/4 M8-1A	2773416	1

Accessories

M8 screw plug	
Zack marker strip, flat, 10-section, without color print	
Manual addressing device, for AS-Interface devices	

Accessories	Order No.	Pcs. / Pkt.
PROT-M8	1682540	5
ZBF 8:UNBEDRUCKT	0808781	10
ASI CC ADR	2741338	1

Accessories

Accessories	Order No.	Pcs. / Pkt.
PROT-M8	1682540	5
ZBF 8:UNBEDRUCKT	0808781	10
ASI CC ADR	2741338	1

Digital I/O devices with M12 connection method

The innovative locking mechanism enables quick and easy installation of the I/O devices.

Features:

- Optimized for direct mounting and DIN rail mounting
- Tool-free connection to AS-Interface using penetration technique
- M12 connection method with SPEEDCON fast locking system for the I/Os



4 digital inputs



4 digital outputs

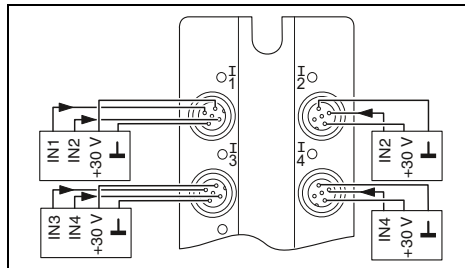

Technical data

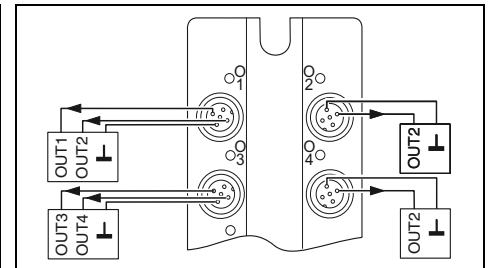

Technical data

Interface	
Fieldbus system	AS-i
Connection method	Flat-ribbon cable penetration technique
AS-Interface	
AS-i specification	2.1
Required master specification	>= 2.0
AS-i profile	S-0.A.2
Digital inputs	
Connection method	M12 connector
Connection technology	2, 3-wire
Maximum number of inputs	-
Input characteristic curve	IEC 61131-2 type 2
Digital outputs	
Connection method	-
Connection technology	-
Maximum number of outputs	-
Maximum output current per channel	-
Maximum output current per module/terminal block	-
General data	
Weight	195 g
Drill hole spacing	108 mm
Dimensions	58 mm / 118 mm / 35 mm
Degree of protection	IP65/IP67
Ambient temperature (operation)	-25 °C ... 70 °C
EMC note	Class A product, see page 730

Interface	
Fieldbus system	AS-i
Connection method	Flat-ribbon cable penetration technique
AS-Interface	
AS-i specification	2.0
Required master specification	>= 2.0
AS-i profile	S-8.1
Digital inputs	
Connection method	-
Connection technology	-
Maximum number of inputs	-
Input characteristic curve	-
Digital outputs	
Connection method	M12 connector
Connection technology	2-wire
Maximum number of outputs	4
Maximum output current per channel	2 A
Maximum output current per module/terminal block	4 A
General data	
Weight	195 g
Drill hole spacing	108 mm
Dimensions	58 mm / 118 mm / 35 mm
Degree of protection	IP65/IP67
Ambient temperature (operation)	-25 °C ... 70 °C
EMC note	Class A product, see page 730

Description	
Fieldline Extension AS-i digital input device	
- 4 inputs	
Fieldline Extension AS-i digital output device	
- 4 outputs, 2 A	
Fieldline Extension AS-i digital I/O device	
- 2 inputs, 2 outputs, 2 A	
- 4 inputs, 3 outputs, 2 A	
- 4 inputs, 4 outputs, 2 A	

Ordering data		
Type	Order No.	Pcs. / Pkt.
FLX ASI DI 4 M12	2773429	1

Ordering data		
Type	Order No.	Pcs. / Pkt.
FLX ASI DO 4 M12-2A	2773458	1

Accessories	
M12 screw plug	PROT-M12
Label sheet for laser printers, 64 x 16 mm, color: white	BMKL 64X16 WH
Label sheet for laser printers, 108 x 16 mm, color: white	
Manual addressing device , for AS-Interface devices	ASI CC ADR
Programming cable , for addressing the AS-i devices	ASI CC ADR CAB CINCH

Accessories		
PROT-M12	1680539	5
BMKL 64X16 WH	0821807	2
ASI CC ADR	2741338	1
ASI CC ADR CAB CINCH	2741341	1

Accessories		
PROT-M12	1680539	5
BMKL 64X16 WH	0821807	2
ASI CC ADR	2741338	1
ASI CC ADR CAB CINCH	2741341	1



2 digital inputs
and 2 digital outputs



4 digital inputs
and 3 digital outputs



4 digital inputs
and 4 digital outputs

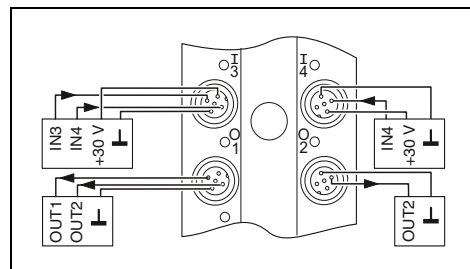
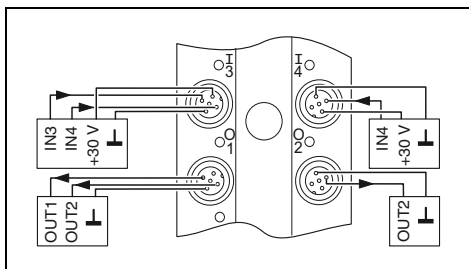
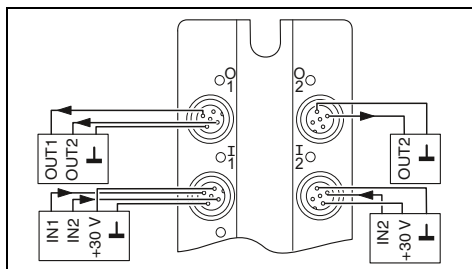

Technical data

AS-i
Flat-ribbon cable penetration technique

2.1
≥ 2.0
S-B.A.2

M12 connector
2, 3-wire
-
IEC 61131-2 type 2

M12 connector
2-wire
-
2 A
4 A

195 g
108 mm
58 mm / 118 mm / 35 mm
IP65/IP67
-25 °C ... 70 °C
Class A product, see page 730

Technical data

AS-i
Flat-ribbon cable penetration technique

2.1
≥ 2.0
S-7.A.2

M12 connector
2, 3-wire
-
IEC 61131-2 type 2

M12 connector
2-wire
-
2 A
4 A

245 g
108 mm
58 mm / 150 mm / 35 mm
IP65/IP67
-25 °C ... 70 °C
Class A product, see page 730

Technical data

AS-i
Flat-ribbon cable penetration technique

3.0
≥ 3.0
S-7.A.7

M12 connector
2, 3-wire
-
IEC 61131-2 type 2

M12 connector
2-wire
-
2 A

245 g
108 mm
58 mm / 150 mm / 35 mm
IP65/IP67
-25 °C ... 70 °C
Class A product, see page 730

Ordering data

Type	Order No.	Pcs. / Pkt.
FLX ASI DIO 2/2 M12-2A	2773432	1

Ordering data

Type	Order No.	Pcs. / Pkt.
FLX ASI DIO 4/3 M12-2A	2773445	1

Ordering data

Type	Order No.	Pcs. / Pkt.
FLX ASI 3.0 DIO 4/4 M12-2A	2773474	1

Accessories

Accessories	Order No.	Pcs. / Pkt.
PROT-M12	1680539	5
BMKL 64X16 WH	0821807	2
ASI CC ADR	2741338	1
ASI CC ADR CAB CINCH	2741341	1

Accessories

Accessories	Order No.	Pcs. / Pkt.
PROT-M12	1680539	5
BMKL 11,5 (108X16) WH	0821797	2
ASI CC ADR	2741338	1
ASI CC ADR CAB CINCH	2741341	1

Accessories

Accessories	Order No.	Pcs. / Pkt.
PROT-M12	1680539	5
BMKL 11,5 (108X16) WH	0821797	2
ASI CC ADR	2741338	1
ASI CC ADR CAB CINCH	2741341	1

D-SUB connector, IP67



D-SUB complete connector for INTERBUS in IP67 protection



D-SUB connector set IP67, consisting of: Sleeve housing, panel mounting frame and accessories, shielded design

ERC

Technical data

Electrical data	
Rated voltage	63 V
Rated current	1 A
Surge voltage category	II
Material data	
Housing material	PA
Contact material	Copper alloy
Contact surface material	Gold over nickel
Contact carrier material	PBTP
Inflammability class according to UL 94	V0
Mechanical data	
No. of pos.	9
Color	Gray
Pollution degree	2
Degree of protection	IP67
Connection method	Screw connection
Conductor cross section	0.14 mm ² ... 0.5 mm ²
Connection cross section AWG	26 ... 20
Insertion/withdrawal cycles	≥ 200
Temperature data	
Ambient temperature (operation)	-20 °C ... 70 °C

ERC

Technical data

Electrical data		
Rated voltage	-	-
Rated current	-	-
Surge voltage category	-	-
Material data		
Housing material	PA	PA
Contact material	-	-
Contact surface material	-	-
Contact carrier material	-	-
Inflammability class according to UL 94	V0	V0
Mechanical data		
No. of pos.	9	9
Color	Gray	Gray
Pollution degree	2	2
Degree of protection	IP67	IP67
Connection method	-	-
Conductor cross section	-	-
Connection cross section AWG	-	-
Insertion/withdrawal cycles	≥ 1000	≥ 1000
Temperature data		
Ambient temperature (operation)	-40 °C ... 80 °C	-40 °C ... 80 °C

Ordering data

Description			
D-SUB complete connector , for INTERBUS, shell size 1, screw connection, shielded			
Pin	VS-09-IBS-ST	1689271	1
Socket	VS-09-IBS-BU	1689284	1
D-SUB complete connector , for PROFIBUS, shell size 1, pin, shielded			
Screw connection	VS-09-PROFIBUS-SC	1654549	1
Spring connection	VS-09-PROFIBUS-SP	1654345	1
D-SUB complete connector , for CANopen®, shell size 1, socket, screw connection, shielded			
Socket	VS-09-CAN	1689307	1
D-SUB panel mounting frame , for taking up D-SUB contact inserts			
D-SUB 09			
D-SUB EMC shroud , for the IP67 panel mounting frame, for shield contacting to the housing panel			
D-SUB 09			
D-SUB connector set			
D-SUB 09			

Ordering data

Description			
D-SUB connector set IP67 , consisting of: Sleeve housing, panel mounting frame and accessories, shielded design			
	VS-09-A	1688366	5
	VS-09-A-EMV-S	1688463	5
	VS-09-SET-EMV	1689158	1



Screw connection
Fixing: 2.5 mm hole



D-SUB panel mounting frame IP67,
with integrated gender changer

ERC

	Technical data
Electrical data	
Rated voltage	60 V
Rated current	5 A
Surge voltage category	III
Material data	
Housing material	-
Contact material	Copper alloy
Contact surface material	Gold over nickel
Contact carrier material	PBTP
Inflammability class according to UL 94	V0
Mechanical data	
No. of pos.	9
Color	-
Pollution degree	2
Degree of protection	IP20
Connection method	Screw connection
Conductor cross section	0.14 mm ² ... 0.5 mm ²
Connection cross section AWG	26 ... 20
Insertion/withdrawal cycles	≥ 200
Temperature data	
Ambient temperature (operation)	-20 °C ... 80 °C

ERC

	Technical data	
Electrical data		
Rated voltage	125 V	125 V
Rated current	5 A	5 A
Surge voltage category	III	III
Material data		
Housing material	PA	PA
Contact material	Copper alloy	Copper alloy
Contact surface material	Hard gold-plated over nickel	Hard gold-plated over nickel
Contact carrier material	Polyester GF	Polyester GF
Inflammability class according to UL 94	V0	V0
Mechanical data		
No. of pos.	9	9
Color	Gray	Gray
Pollution degree	2	2
Degree of protection	IP67	IP67
Connection method	-	-
Conductor cross section	-	-
Connection cross section AWG	-	-
Insertion/withdrawal cycles	≥ 200	≥ 200
Temperature data		
Ambient temperature (operation)	-40 °C ... 80 °C	-40 °C ... 80 °C

	Ordering data		
Description	Type	Order No.	Pcs. / Pkt.
D-SUB contact insert			
Pin	VS-09-ST-DSUB/10-MPT-0,5	1688379	10
Socket	VS-09-BU-DSUB/9-MPT-0,5	1688395	10
D-SUB panel mounting frame, with integrated gender changer, shielded			
D-SUB 09, pin/pin			
D-SUB 09, socket/socket			
D-SUB coupling, with integrated gender changer, shielded			
D-SUB 09, pin/pin			
D-SUB 09, socket/socket			

	Ordering data		
Description	Type	Order No.	Pcs. / Pkt.
D-SUB panel mounting frame, with integrated gender changer, shielded			
D-SUB 09, pin/pin	VS-09-A-GC-ST/ST	1689705	5
D-SUB 09, socket/socket	VS-09-A-GC-BU/BU	1689695	5
D-SUB coupling, with integrated gender changer, shielded			
D-SUB 09, pin/pin	VS-09-KU-ST/ST	1689640	5
D-SUB 09, socket/socket	VS-09-KU-BU/BU	1689637	5

D-SUB based connector

Signal contacts



Contacts for standard D-SUB contact carriers



Contacts for high density D-SUB contact carriers

ERC

Technical data

AWG 28 ... 24	AWG 24 ... 20
125 V	125 V
5 A	5 A
Copper alloy	Copper alloy
Hard gold-plated over nickel	Hard gold-plated over nickel
Crimp connection	Crimp connection
0.08 mm ² ... 0.2 mm ²	0.2 mm ² ... 0.5 mm ²
28 ... 24	24 ... 20
≥ 200	≥ 200
-55 °C ... 125 °C	-55 °C ... 125 °C

Ordering data

Type	Order No.	Pcs. / Pkt.
VS-ST-CD-1,0/14,8/0,2	1688971	30
VS-ST-CD-1,0/14,8/0,5	1688968	30
VS-BU-CD-1,0/14,4/0,2	1688997	30
VS-BU-CD-1,0/14,4/0,5	1688984	30

Accessories

CRIMPFOX RC 2,5	1205448	1
VS-IET-DSUB-SIGNAL-STD	1658794	1

ERC

Technical data

VS-...-CD-HD-1,0/13,5/0,37
60 V
3 A
Copper alloy
Hard gold-plated over nickel
Crimp connection
0.34 mm ²
22
≥ 200
-55 °C ... 125 °C

Ordering data

Type	Order No.	Pcs. / Pkt.
VS-ST-CD-HD-1,0/13,5/0,37	1655276	100
VS-BU-CD-HD-1,0/13,5/0,37	1655263	100

Accessories

CRIMPFOX RC 2,5	1205448	1
VS-IET-DSUB-SIGNAL-HD	1658503	1

Electrical data
Rated voltage
Rated current
Contact material
Contact surface material
Mechanical data
Connection method
Conductor cross section
Connection cross section AWG
Insertion/withdrawal cycles
Temperature data
Ambient temperature (operation)

Description
Turned pin crimp contacts , for D-SUB contact inserts with standard contact density, gold-plated surface
AWG 28 ... 24
AWG 24 ... 20
Turned crimp contacts VS 1,0
Gold-plated
Turned crimp contacts , for D-SUB contact inserts with high density, gold-plated surface
AWG 22, pin
AWG 22, socket

Crimping pliers
- For turned contacts VS...CD (D-SUB contacts); crimping tool with four mandrels
Insertion/Extraction Tool , for fitting and removing the D-SUB standard signal contacts
Insertion/Extraction Tool , for fitting and removing the D-SUB High Density signal contacts

Power contacts



With straight solder cups or angled solder pins

With screw connection

ERC

ERC

Technical data	
VS-.../2,6	VS-.../4,6
Electrical data	
Rated voltage	-
Rated current	20 A / 40 A
Material data	
Contact material	Copper alloy
Contact surface material	Hard gold-plated over nickel
Mechanical data	
Connection method	Solder cup
Conductor cross section	2 mm ² ... 3.5 mm ² / 4.5 mm ² ... 8.5 mm ²
Connection cross section AWG	14 ... 12 / 10 ... 8
Insertion/withdrawal cycles	≥ 500 / ≥ 500
Temperature data	
Ambient temperature (operation)	-55 °C ... 155 °C / -55 °C ... 155 °C

Technical data	
VS-...SC-2,6	
Electrical data	
Rated voltage	-
Rated current	20 A
Material data	
Contact material	Copper alloy
Contact surface material	Hard gold-plated over nickel
Mechanical data	
Connection method	Screw connection
Conductor cross section	0.75 mm ² ... 2 mm ²
Connection cross section AWG	18 ... 14
Insertion/withdrawal cycles	≥ 500
Temperature data	
Ambient temperature (operation)	-55 °C ... 155 °C









Ordering data		
Type	Order No.	Pcs. / Pkt.
Power contact , for D-SUB combination inserts, with straight solder cup, gold-plated surface		
Up to 20 A, pin	VS-ST-LK-3,6/22,4/2,6	1688243 / 30
Up to 40 A, pin	VS-ST-LK-3,6/22,4/4,6	1688269 / 30
Up to 20 A, socket	VS-BU-LK-3,6/22,8/2,6	1688256 / 30
Up to 40 A, socket	VS-BU-LK-3,6/22,8/4,6	1688272 / 30
Power contact , for D-SUB combination inserts, with angled solder pins for PCB mounting, gold-plated surface		
Up to 40 A, pin	VS-ST-LH-3,6/18/3,8	1655467 / 30
Up to 40 A, socket	VS-BU-LH-3,6/18/3,8	1655454 / 30

Ordering data		
Type	Order No.	Pcs. / Pkt.
Power contact , for D-SUB combination inserts, with straight screw connection, gold-plated surface		
Up to 40 A, pin	VS-ST-SC-2,6	1655483 / 30
Up to 40 A, socket	VS-BU-SC-2,6	1655470 / 30







Accessories		
HC-M4-KOAX-EWZ	1676747	1

Accessories		
HC-M4-KOAX-EWZ	1676747	1

Removal tool	
--------------	--

Shell size 1 ... 3				Signal transmission								
				Screw connection			Solder connection					
												
							Straight solder cups					
				VS-...-ST-DSUB/...-MPT-0,5 VS-...-BU-DSUB/...-MPT-0,5			VS-...-ST-DSUB-EG VS-...-BU-DSUB-EG			VS-...-ST-DSUB-HD-EG VS-...-BU-DSUB-HD-EG		
				D-SUB contact insert Fixing: 2.5 mm hole			D-SUB contact insert Fixing: 3 mm hole			D-SUB contact insert, high-pos. Fixing: 3 mm hole		
Type	Order No.		Number of positions	Pin	Socket	Number of positions	Pin	Socket	Number of positions	Pin	Socket	
	IP67 panel mounting frame											
	VS-09-A	1688366		9	1688379	1688395	9	1688793	1688803	15	1655111	1655108
	VS-15-A	1688036		15	1688078	1688094	15	1688874	1688887	26	1655179	1655166
	VS-25-A	1689750		25	1689789	1689776	25	1689899	1689909	44	1655234	1655221
	VS-25-A	1689750										
	IP20 sleeve housing											
	VS-09-T-20-1-S-A	1655661					9	1688793	1688803	15	1655111	1655108
	VS-15-T-20-1-S-A	1655687					15	1688874	1688887	26	1655179	1655166
	VS-25-T-20-1-S-A	1655700					25	1689899	1689909	44	1655234	1655221
	VS-09-T-20-1-S-S	1655658					9	1688793	1688803	15	1655111	1655108
	VS-15-T-20-1-S-A	1655687					15	1688874	1688887	26	1655179	1655166
	VS-25-T-20-1-S-S	1655690					25	1689899	1689909	44	1655234	1655221
	IP67 sleeve housing											
	VS-09-T-2M16	1688353		9	1688379	1688395	9	1688793	1688803	15	1655111	1655108
	VS-15-T-2Pg11	1688052		15	1688078	1688094	15	1688874	1688887	26	1655179	1655166
	VS-25-T-2M20	1689792		25	1689789	1689776	25	1689899	1689909	44	1655234	1655221
	VS-25-T-2M20	1689792										
	VS-09-SET-STD	1689145	Panel mounting frame	9	1688379	1688395	9	1688793	1688803	15	1655111	1655108
			Sleeve housing	9	1688379	1688395	9	1688793	1688803	15	1655111	1655108
	VS-15-SET-STD	1689129	Panel mounting frame	15	1688078	1688094	15	1688874	1688887	26	1655179	1655166
Sleeve housing			15	1688078	1688094	15	1688874	1688887	26	1655179	1655166	
VS-25-SET-STD	1652198	Panel mounting frame	25	1689789	1689776	25	1689899	1689909	44	1655234	1655221	
		Sleeve housing	25	1689789	1689776	25	1689899	1689909	44	1655234	1655221	
VS-25-SET-STD	1652198	Panel mounting frame										
	VS-09-SET-EMV	1689158	Panel mounting frame	9	1688379	1688395	9	1688793	1688803	15	1655111	1655108
			Sleeve housing	9	1688379	1688395	9	1688793	1688803	15	1655111	1655108
	VS-15-SET-EMV	1689132	Panel mounting frame	15	1688078	1688094	15	1688874	1688887	26	1655179	1655166
			Sleeve housing	15	1688078	1688094	15	1688874	1688887	26	1655179	1655166
	VS-25-SET-EMV	1652208	Panel mounting frame	25	1689789	1689776	25	1689899	1689909	44	1655234	1655221
			Sleeve housing	25	1689789	1689776	25	1689899	1689909	44	1655234	1655221
	VS-25-SET-EMV	1652208	Panel mounting frame									
			Sleeve housing									

Note:
The EMC inner sleeve of the IP67 sleeve housing cannot be used on the panel mounting side.

Signal transmission									Power and signal transmission						Power	
Solder connection			Crimp connection						Solder connection						Screw connection	
																
Angled solder pins			Contact carriers for crimp contacts												3/5-pos.	
VS-...-ST-DSUB-LH-B VS-...-BU-DSUB-LH-B			VS-...-ST-DSUB-CD-... VS-...-BU-DSUB-CD-...			VS-...-ST-DSUB-HD-CD-B VS-...-BU-DSUB-HD-CD-B			VS-...-ST-DSUB-...P VS-...-BU-DSUB-...P			VS-...-ST-DSUB-...P-...S VS-...-BU-DSUB-...P-...S			PSC 1,5/...-F	
D-SUB contact insert Fixing: 2.5 mm hole and solder metal plate			D-SUB contact carrier Fixing: 3 mm hole			D-SUB contact carrier, high-pos. Fixing: 3 mm hole			D-SUB contact carrier Fixing: 3 mm hole			D-SUB contact insert Fixing: 3 mm hole			D-SUB contact insert Fixing: 3 mm hole	
Number of positions	Pin	Socket	Number of positions	Pin	Socket	Number of positions	Pin	Socket	Number of positions	Pin	Socket	Number of positions	Pin	Socket	Number of positions	Socket
9	1654785	1654798	9	1688858	1688861	15	1655137	1655124	2PK	1688418	1688421	1PK-4S	1689006	1689019		
15	1654808	1654811	15	1688939	1688942	26	1655195	1655182	3PK	1688201	1688214	2PK-5S	1688227	1688230		
25	1654824	1654837	25	1689954	1689967	44	1655250	1655247	5PK	1689970	1689983	3PK-10S	1689996	1690008		
												4PK-5S	1655386	1655373		
9	1654785	1654798	9	1688858	1688861	15	1655137	1655124							3	1841909
15	1654808	1654811	15	1688939	1688942	26	1655195	1655182							5	1841912
25	1654824	1654837	25	1689954	1689967	44	1655250	1655247								
9	1654785	1654798	9	1688858	1688861	15	1655137	1655124							3	1841909
15	1654808	1654811	15	1688939	1688942	26	1655195	1655182							5	1841912
25	1654824	1654837	25	1689954	1689967	44	1655250	1655247								
9	1654785	1654798	9	1688858	1688861	15	1655137	1655124	2PK	1688418	1688421	1PK-4S	1689006	1689019	3	1841909
15	1654808	1654811	15	1688939	1688942	26	1655195	1655182	3PK	1688201	1688214	2PK-5S	1688227	1688230	5	1841912
25	1654824	1654837	25	1689954	1689967	44	1655250	1655247	5PK	1689970	1689983	3PK-10S	1689996	1690008		
												4PK-5S	1655386	1655373		
9	1654785	1654798	9	1688858	1688861	15	1655137	1655124	2PK	1688418	1688421	1PK - 4S	1689006	1689019		
9	1654785	1654798	9	1688858	1688861	15	1655137	1655124	2PK	1688418	1688421	1PK - 4S	1689006	1689019	3	1841909
15	1654808	1654811	15	1688939	1688942	26	1655195	1655182	3PK	1688201	1688214	2PK - 5S	1688227	1688230		
15	1654808	1654811	15	1688939	1688942	26	1655195	1655182	3PK	1688201	1688214	2PK - 5S	1688227	1688230	5	1841912
25	1654824	1654837	25	1689954	1689967	44	1655250	1655247	5PK	1689970	1689983	3PK-10S	1689996	1690008		
25	1654824	1654837	25	1689954	1689967	44	1655250	1655247	5PK	1689970	1689983	3PK-10S	1689996	1690008		
												4PK - 5S	1655386	1655373		
												4PK - 5S	1655386	1655373		
9	1654785	1654798	9	1688858	1688861	15	1655137	1655124	2PK	1688418	1688421	1PK - 4S	1689006	1689019		
9	1654785	1654798	9	1688858	1688861	15	1655137	1655124							3	1841909
15	1654808	1654811	15	1688939	1688942	26	1655195	1655182	3PK	1688201	1688214	2PK - 5S	1688227	1688230		
15	1654808	1654811	15	1688939	1688942	26	1655195	1655182							5	1841912
25	1654824	1654837	25	1689954	1689967	44	1655250	1655247	5PK	1689970	1689983	3PK-10S	1689996	1690008		
25	1654824	1654837	25	1689954	1689967	44	1655250	1655247								
												4PK - 5S	1655386	1655373		

Data connectors and cables

USB connectors

Assembled cables, IP20/IP67

USB type A connector, IP20



USB type A connector, IP67



Free end	Ordering data		Ordering data		Ordering data
		Order No.		Order No.	Order No.
	1 m	1655771	1 m	1655742	
	2 m	1655784	2 m	1655755	
	5 m	1655797	5 m	1655768	
USB type B connector, IP20 	1 m	1654853	2 m	1653896	
	2 m	1653935	5 m	1653906	
	5 m	1653948			
USB type B connector, IP67 	2 m	1653919	2 m	1653870	
	5 m	1653922	5 m	1653883	
M12 Mini USB, SPEEDCON 	1 m	1420168			
	2 m	1420171			
	5 m	1420184			

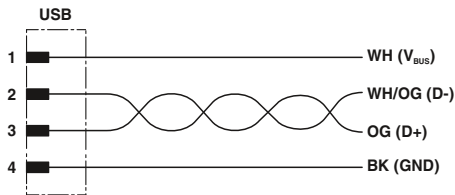

USB cable with a free end

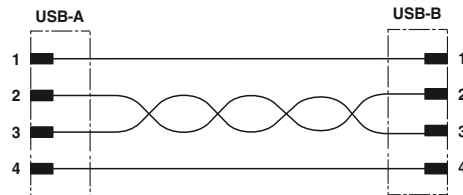

USB connector pin assignment

	Technical data	
	IP20	IP67
Transmission characteristics (category)	USB 2.0	USB 2.0
Cable diameter [mm]	6.7	6.7
Housing material	PA	PA
Handle color	Black	Gray
No. of pos.	4	4
Degree of protection	IP20	IP67
Temperature data		
Cable, fixed installation [°C]	-20 ... 60	-20 ... 60
Cable, flexible installation [°C]	0 ... 50	0 ... 50

Panel feed-throughs, memory sticks, protective cover

Panel feed-throughs can be implemented with the IP67 panel mounting frame and the USB socket inserts. The USB memory sticks with IP67 protection enable wireless data transmission in rough industrial environments.



USB panel mounting frame

		Technical data		
		VS-04-BUA-BUB-F/IP67		
Electrical data				
Rated voltage		30 V		
Transmission speed		-		
Material data				
Housing material		PC		
Inflammability class according to UL 94		V0		
Mechanical data				
No. of pos.		4		
Degree of protection		IP67		
Insertion/withdrawal cycles		-		
Temperature data				
Ambient temperature (operation)		-15 °C ... 65 °C		
		Ordering data		
Description	Cable length	Type	Order No.	Pcs. / Pkt.
Version 6, panel mounting frame with USB coupling:				
Slot V6 with USB-B		CUC-V06-F1PGY-UBB/UBAB	1411905	1
Slot V6 with USB-A		CUC-V06-F1PGY-UBA/UBBB	1411904	1
USB socket insert, 4-pos., socket on flat-ribbon cable terminal strip, pitch 2.54				
Socket, type A		VS-04-BUA-FK-F/IP67	1653854	1
Socket, type B		VS-04-BUB-FK-F/IP67	1653867	1
USB cable, assembled on one side with USB connectors				
Connector type: A, length: 0.3 m	0.3 m	VS-04-C-SDA/PH/0,3	1405552	1
Connector type: B, length: 0.3 m	0.3 m	VS-04-C-SDB/PH/0,3	1405565	1
Connector type: A to B, length: 1.8 m	1.8 m	VS-04-C-SDA/SDB/1,8	1405578	1
Freenet panel mounting frame, Version 6, for round mounting cutout, with seal, without mounting screws				
Military gray RAL 7042		VS-A-F-IP67	1653744	5
USB memory stick, USB 2.0				
IP67		VS-04-MS-IP67	1402489	1
Protective cover for Version 6 panel mounting frame				
Military gray RAL 7042		VS-08-SD-F	1652606	5

Data connectors and cables

Cable range

Symbol key



With UL Style



Suitable for drag chain applications



Resistant to welding sparks



UV resistant



Extremely flame-retardant



High temperature resistance



Good oil resistance



Good resistance to chemicals



Suitable for torsional stress



Halogen-free



Transmission properties



Suitable for railway applications

INTERBUS cable – type 900



INTERBUS cable for highly flexible use in dry and humid rooms and harsh industrial environments. The remote bus cable is certified in accordance with the requirements of the INTERBUS Club under No. 117.

The cable is halogen-free and flame-retardant according to VDE 0482, Part 265-2-1/IEC 332-1. The wire insulation of the inner conductor is made from polyethylene.

Outer sheath material PVC
Minimum bending radius 7.5 x D
Tested at 20 ... 25°C

Type	Number of positions	Use	Structure	Cross section	Wire colors	Wire insulation	Temperature range	Page
900 PVC Green	6-pos.	M12	3 x 2 x 0.25 mm ² 32 x 0.1 mm		Yellow, green, white, brown, pink, gray	PE	-30°C ... 70°C	409 412

PROFIBUS cable – type 910



PROFIBUS cable, suitable for use in drag chains in harsh industrial environments. The cable is also oil resistant.

Outer sheath material PUR
Number of bending cycles 5 million
Minimum bending radius 10 x D
Traverse path 10 m
Acceleration 7 m/s²
Speed 180 m/min.
Tested at 20 ... 25°C

Type	Number of positions	Use	Structure	Cross section	Wire colors	Wire insulation	Temperature range	Page
910 PUR Violet	2-pos.	M12	1 x 2 x 24 AWG 19 x 0.15 mm		Green, red	PE	-40°C ... 80°C	410 413

DeviceNet™/CANopen® cable – type 920



DeviceNet™/CANopen® cable for flexible installation. The cable is suitable for drag chain applications and use in harsh industrial environments. The cable is also oil resistant.

Outer sheath material	PUR
Number of bending cycles	5 million
Minimum bending radius	10 x D
Traverse path	10 m
Acceleration	7 m/s ²
Speed	180 m/min.
Tested at	20 ... 25°C

Type	Number of positions	Use	Structure	Cross section	Wire colors	Wire insulation	Temperature range	Page
920 PUR Violet	4-pos.	M12, M8	1 x 2 x 22 AWG 19 x 0.15 mm + 1 x 2 x 24 AWG 19 x 0.15 mm		Red, black, blue, white	PO, PE	-40°C ... 80°C	411 416 417 420

DeviceNet™/CANopen® cable – type 923



DeviceNet™/CANopen® cable for flexible installation. The cable is suitable for drag chain applications and use in harsh industrial environments. The cable is also oil resistant.

Outer sheath material	PUR
Number of bending cycles	5 million
Minimum bending radius	10 x D
Traverse path	10 m
Acceleration	7 m/s ²
Speed	180 m/min.
Tested at	20 ... 25°C

Type	Number of positions	Use	Structure	Cross section	Wire colors	Wire insulation	Temperature range	Page
923 PUR Gray	4-pos.	M12, 7/8"	1 x 2 x 22 AWG 19 x 0.15 mm + 1 x 2 x 24 AWG 19 x 0.15 mm		Red, black, blue, white	PO, PE	-40°C ... 80°C	415 418

DeviceNet™ cable - type 928



DeviceNet™/CANopen® cable for fixed installation. The cable is suitable for use in harsh industrial environments. The cable is also oil resistant.

Outer sheath material	PVC
Minimum bending radius	10 x D

Type	Number of positions	Use	Structure	Cross section	Wire colors	Wire insulation	Temperature range	Page
928 PVC Gray	4-pos.	7/8"	1 x 2 x 18 AWG 19 x 0.26 mm + 1 x 2 x 15 AWG 19 x 0.34 mm		Red, black, blue, white	PVC	Fixed: -40°C ... 80°C	419

Data connectors and cables

Cable range

FOUNDATION Fieldbus cable – type 960

FOUNDATION Fieldbus/PROFIBUS PA cable – type 961



FOUNDATION Fieldbus cable for fixed installation. The cable is UV resistant and flame-retardant according to UL 1685. This makes it suitable for use both outdoors and indoors.

Cable type 961 is available in a blue version designed specifically for use in the hazardous area.

Outer sheath material PVC

Minimum bending radius 10 x D

Type	Number of positions	Use	Structure	Cross section	Wire colors	Wire insulation	Temperature range	Page
960 PVC Orange	2-pos.	7/8", M12	2 x 20 AWG 7 x 0.3 mm		Blue, orange	PO	-30°C ... 105°C	422
961 PVC Blue	2-pos.	7/8", M12	2 x 20 AWG 7 x 0.3 mm		Blue, orange	PO	-30°C ... 105°C	414 421

CC-Link cable – type 990



CC-Link cable for fixed indoor installation. The cable is flame-retardant according to UL 1685.

Outer sheath material PVC

Type	Number of positions	Use	Structure	Cross section	Wire colors	Wire insulation	Temperature range	Page
990 PVC Red	3-pos.	M12	3 x 22 AWG 7 x 0.28 mm		White, blue, yellow	Foam PE	-30°C ... 60°C	See: phoenix contact.net/ products

PROFINET cable – type 93A



PROFINET cable for fixed installation. The cable is flame-retardant and its transmission properties meet CAT5.

Outer sheath material PVC

Minimum bending radius 7.5 x D

Type	Number of positions	Use	Structure	Cross section	Wire colors	Wire insulation	Temperature range	Page
93A PVC Green	4-pos.	M12, RJ45	4 x 22 AWG single-strand		White, yellow, blue, orange	PE	-25°C ... 80°C	380

PROFINET cable – type 93B



PROFINET cable for flexible installation. The cable is oil resistant. It is UV resistant according to UL 1581 Sec. 1200 and therefore also suitable for outdoor use. The cable's transmission properties meet CAT5.

Outer sheath material PVC
Minimum bending radius 7 x D
Tested at 20 ... 25°C

Type	Number of positions	Use	Structure	Cross section	Wire colors	Wire insulation	Temperature range	Page
93B PVC Green	4-pos.	M12, RJ45	4 x 22 AWG 7 x 0.25 mm		White, yellow, blue, orange	PE	-40°C ... 70°C	386 380 382

PROFINET cable – type 93C



PROFINET cable for use in drag chains. The cable is halogen-free and oil resistant. It is UV resistant and therefore also suitable for outdoor use. The cable's transmission properties meet CAT5.

Outer sheath material PUR
Number of bending cycles 3 million
Minimum bending radius 7.5 x D
Traverse path 10 m
Acceleration 4 m/s²
Speed 4 m/s
Tested at 20 ... 25°C

Type	Number of positions	Use	Structure	Cross section	Wire colors	Wire insulation	Temperature range	Page
93C PUR Green	4-pos.	M12, RJ45	4 x 22 AWG 7 x 0.25 mm		White, yellow, blue, orange	PE	-40°C ... 70°C	380 382

PROFINET cable – type 93R



PROFINET cable for robot applications. The cable is oil resistant. It is UV resistant according to UL 1581 Sec. 1200 and therefore also suitable for outdoor use. The cable's transmission properties meet CAT5.

Outer sheath material PUR
Torsion angle ±180°
Torsion cycles 1 million

Type	Number of positions	Use	Structure	Cross section	Wire colors	Wire insulation	Temperature range	Page
93R PUR Green	4-pos.	M12, RJ45	4 x 22 AWG 19 x 0.15 mm		White, yellow, blue, orange	PE	-40°C ... 80°C	380 382

Data connectors and cables

Cable range

PROFINET cable – type 937



PROFINET cable for railway applications. The cable is oil resistant. It meets fire safety standard BS6853.

The cable's transmission properties meet CAT5.

Outer sheath material RADOX® GKW S

Minimum bending radius 6 x D

Type	Number of positions	Use	Structure	Cross section	Wire colors	Wire insulation	Temperature range	Page
937 RADOX® Black	4 pos.	M12, RJ45	4 x 22 AWG 7 x 0.25 mm		White, yellow, blue, orange	RADOX®	-40°C ... 90°C	380 382

EtherCAT® cable - type 93G

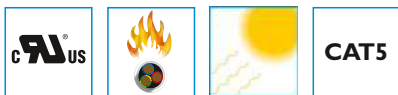

EtherCAT® cable for flexible installation. The cable is oil resistant. It is UV resistant according to UL 1581 Sec. 1200 and is therefore also suitable for use in harsh industrial environments. The cable's transmission properties meet CAT5.

Outer sheath material PVC

Minimum bending radius 7 x D
Tested at 20 ... 25°C

Type	Number of positions	Use	Structure	Cross section	Wire colors	Wire insulation	Temperature range	Page
93G PVC Green	4 pos.	M12, PP, RJ45	4 x 22 AWG 7 x 0.25 mm		White, yellow, blue, orange	PE	-40°C ... 70°C	384

Sercos® cable - type 93K

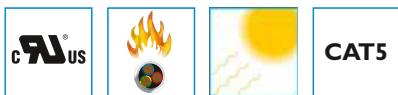

Sercos® cable for flexible installation. The cable is oil resistant. It is UV resistant according to UL 1581 Sec. 1200 and is therefore also suitable for use in harsh industrial environments. The cable's transmission properties meet CAT5.

Outer sheath material PVC

Minimum bending radius 7 x D
Tested at 20 ... 25°C

Type	Number of positions	Use	Structure	Cross section	Wire colors	Wire insulation	Temperature range	Page
93K PVC Red	4 pos.	M12, PP, RJ45	4 x 22 AWG 7 x 0.25 mm		White, yellow, blue, orange	PE	-40°C ... 70°C	See: phoenix contact.net/ products

Ethernet cable – type 93E



Ethernet cable for flexible use. The cable is halogen-free and oil resistant. Its transmission properties meet CAT5.

Outer sheath material PUR
Minimum bending radius 5 x D

Type	Number of positions	Use	Structure	Cross section	Wire colors	Wire insulation	Temperature range	Page
93E PUR Blue	4 pos.	M12, RJ45	2 x 2 x 26 AWG 7 x 0.25 mm		White/orange-orange, white/green-green	PE	-20°C ... 80°C	381 388

Ethernet cable – type 94A



Ethernet cable for fixed installation. The cable's transmission properties meet CAT5.

Outer sheath material PUR
Minimum bending radius 7 x D
Tested at 20 ... 25°C

Type	Number of positions	Use	Structure	Cross section	Wire colors	Wire insulation	Temperature range	Page
94A PUR Blue	8-pos.	M12, PP, RJ45	4 x 2 x 24 AWG single-strand Twisted pair		White/blue-blue, white/orange-orange, white/green-green, white/brown-brown	PE	-20°C ... 70°C	381

Ethernet cable – type 94B



Ethernet cable for flexible installation. The cable is resistant to oil and chemicals and is flame-retardant. The cable's transmission properties meet CAT5.

Outer sheath material PUR
Minimum bending radius 5 x D

Type	Number of positions	Use	Structure	Cross section	Wire colors	Wire insulation	Temperature range	Page
94B PUR Blue	8-pos.	M12, RJ45	4 x 2 x 26 AWG 7 x 0.25 mm		White/blue-blue, white/orange-orange, white/green-green, white/brown-brown	PE	-40°C ... 80°C	381 390

Cable range

Ethernet cable – type 94P



Ethernet cable for flexible installation. The cable is flame-retardant and halogen-free. The cable's transmission properties meet CAT5.

Outer sheath material PUR
Minimum bending radius 90 mm (mobile)
 50 mm (fixed installation)

Type	Number of positions	Use	Structure	Cross section	Wire colors	Wire insulation	Temperature range	Page
94P PUR Blue	8-pos.	M12, RJ45	4 x 2 x 26 AWG 7 x 0.16 mm		White-blue, blue, white-orange, orange, white-green, green, white-brown, brown	PE	-20°C ... 70°C	374

Ethernet cable – type 94C



Ethernet cable for universal use in drag chains. The cable is resistant to oil and chemicals and is flame-retardant. The cable's transmission properties meet CAT5.

Outer sheath material PUR
Minimum bending radius 5 x D

Type	Number of positions	Use	Structure	Cross section	Wire colors	Wire insulation	Temperature range	Page
94C PUR Blue	8-pos.	M12, RJ45	4 x 2 x 26 AWG 19 x 0.10 mm		White-blue, blue, white-orange, orange, white-green, green, white-brown, brown	PP	-20°C ... 80°C	381 390

Ethernet cable – type 94D



Ethernet cable for flexible installation. The cable is oil resistant. It is UV resistant according to UL 1581 Sec. 1200 and therefore also suitable for outdoor use. The cable's transmission properties meet CAT5.

Outer sheath material PVC

Type	Number of positions	Use	Structure	Cross section	Wire colors	Wire insulation	Temperature range	Page
94D PVC Black	8-pos.	M12, PP, RJ45	4 x 2 x 26 AWG 7 x 0.16 mm Twisted pair		White-blue, blue, white-orange, orange, white-green, green, white-brown, brown	PP	-40°C ... 80°C	381

Ethernet cable – type 94E



Ethernet cable for fixed installation. The cable is resistant to oil and chemicals and is flame-retardant. It is also halogen-free and its transmission properties meet CAT6_A.

Outer sheath material PUR

Type	Number of positions	Use	Structure	Cross section	Wire colors	Wire insulation	Temperature range	Page
94E PUR Blue	8-pos.	M12, PP, RJ45	4 x 2 x 23 AWG single-strand Twisted pair		White-blue, blue, white-orange, orange, white-green, green, white-brown, brown	PE	-20°C ... 80°C	381

Ethernet cable – type 94F



Ethernet cable for flexible installation. The cable is resistant to oil and chemicals and is flame-retardant. It is also halogen-free and its transmission properties meet CAT6_A.

Outer sheath material PUR

Minimum bending radius 10 x D

Type	Number of positions	Use	Structure	Cross section	Wire colors	Wire insulation	Temperature range	Page
94F PUR Blue	8-pos.	M12, PP, RJ45	4 x 2 x 26 AWG 7 x 0.16 mm Twisted pair		White-blue, blue, white-orange, orange, white-green, green, white-brown, brown	PE	-20°C ... 80°C	392

Ethernet hybrid cable – type 94H



Ethernet hybrid cable for drag chain application. The cable has four wires for data transmission and four wires for power supply. It is oil resistant and flame-retardant. It is also halogen-free and its transmission properties meet CAT5.

Outer sheath material PUR

Number of bending cycles 2 million

Minimum bending radius 10 x D

Traverse path 4.5 m

Acceleration 3 m/s²

Speed 3 m/s

Type	Number of positions	Use	Structure	Cross section	Wire colors	Wire insulation	Temperature range	Page
94H PUR Black	8-pos.	M12	1 x 4 x 26 AWG 19 x 0.15 mm 1 x 4 x 20 AWG 19 x 0.6 mm		White-orange, orange, white-green, green, white, blue, brown, black	PP	-40°C ... 90°C	395

Data connectors and cables

Cable range

VARAN cable – type 970



VARAN cable for flexible installation. The cable is resistant to oil and chemicals and is flame-retardant. The cable's transmission properties meet CAT5.

Outer sheath material Santoprene

Minimum bending radius 7.5 x D
Tested at 20 ... 25°C

Type	Number of positions	Use	Structure	Cross section	Wire colors	Wire insulation	Temperature range	Page
970 Santoprene Black	6-pos.	M12, PP, RJ45	1 x 2 x 22 AWG 19 x 0.1 mm + 2 x 2 x 26 AWG 19 x 0.1 mm		Brown, blue White-orange, orange, white-green, green	PE	-40°C ... 80°C	See: phoenix contact.net/ products



Installation systems

QPD installation system

Industrial power distribution does not have to be time-consuming or complicated. The robust IP68/IP69K installation system for capacities up to 690 V/40 A from Phoenix Contact is proof of this.

Thanks to the proven QUICKON IDC fast connection, cables up to 5 x 6.0 mm² can be connected quickly and easily, without the need for stripping or special tools.

The system, which consists of H- and T-distributors, panel feed-throughs, connectors, and cable connectors, offers a wide range of options for power distribution in industrial environments and building installation.

1.5 mm² installation system

H-distributor	452
T-distributor	453
Cable connectors	454
Panel feed-throughs	456
Connectors	459
Accessories	460

2.5 mm² installation system

H-distributor	461
T-distributor	462
Cable connectors	463
Panel feed-throughs	464
Connectors	467
Accessories	468

6.0 mm² installation system

H-distributor	469
T-distributor	470
Cable connectors	471
Panel feed-throughs	472
Connectors	473
Accessories	474

Special solutions	475
--------------------------	------------

Installation system

1.5 mm² installation system

H-distributor, 1.5 mm²

- Can be used as a H-distributor with continuous master cable
- Can be used as a star distributor
- Can be used as a Y-distributor with a test connection
- Touch-proof in accordance with DIN EN 50274
- Also available as gray color versions

new

new



With four QUICKON nuts



Without QUICKON nut

	Technical data			Technical data			
	2+PE-pos.	3+PE-pos.	4+PE-pos.	2+PE-pos.	3+PE-pos.	4+PE-pos.	
General data							
Degree of protection		IP68 / IP69K			IP68 / IP69K		
Electrical data							
Rated voltage (III/3)		690 V			690 V		
Rated surge voltage		6 kV			6 kV		
Rated current		17.5 A			17.5 A		
Surge voltage category/pollution degree		III / 3			III / 3		
Material data							
Housing material		PA			PA		
Contact material		Cu			Cu		
Inflammability class according to UL 94		V0			V0		
Mechanical data							
Impact category		IK07			IK07		
Color		Black			Black		
Connector data QUICKON connection							
Core insulation		PVC/PE/TPE/rubber			PVC/PE/TPE/rubber		
Structure of individual litz wire/smallest wire diameter		VDE 0295 class 1 to 6/min. 0.15 mm			VDE 0295 class 1 to 6/min. 0.15 mm		
Connection frequency		max. 10			max. 10		
Conductor cross section [mm ²] solid/stranded		0.5 mm ² ... 1.5 mm ² / 0.5 mm ² ... 1.5 mm ²			0.5 mm ² ... 1.5 mm ² / 0.5 mm ² ... 1.5 mm ²		
Conductor cross section [AWG]		20 ... 16			20 ... 16		
Temperature data							
Ambient temperature (operation)		-40 °C ... 80 °C			-40 °C ... 80 °C		
Temperature when conductor connected		-5 °C ... 50 °C			-5 °C ... 50 °C		
	Ordering data			Ordering data			
Description	Order No.	Pcs. / Pkt.	Order No.	Pcs. / Pkt.	Order No.	Pcs. / Pkt.	
	2+PE-pos.		3+PE-pos.		4+PE-pos.		
H-distributor, with four QUICKON nuts and one sealing bolt, for cable diameters:							
4 mm ... 9 mm	1414719	1	1414715	1			
8 mm ... 13 mm	1414720	1	1414716	1			
5 mm ... 10 mm					1414755	1	
9 mm ... 14 mm					1414756	1	
H-distributor, without QUICKON nuts							
					1414721	1	
					1414717	1	
					1414757	1	
QUICKON nut, for connections up to 1.5 mm², for cable diameter:							
4 mm ... 9 mm					1415099	1	
8 mm ... 13 mm					1415100	1	
5 mm ... 10 mm					1415097	1	
9 mm ... 14 mm					1415098	1	
						1415101	1
						1415104	1

T-distributor, 1.5 mm²

new

new

- Can be used as a T-distributor with continuous master cable
- Touch-proof in accordance with DIN EN 50274
- Also available as gray color versions



With three QUICKON nuts



With two QUICKON nuts

	Technical data					
	2+PE-pos.		3+PE-pos.		4+PE-pos.	
General data						
Degree of protection	IP68 / IP69K					
Electrical data						
Rated voltage (III/3)					690 V	
Rated surge voltage					6 kV	
Rated current					17.5 A	
Surge voltage category/pollution degree					III / 3	
Material data						
Housing material					PA	
Contact material					Cu	
Inflammability class according to UL 94					V0	
Mechanical data						
Impact category					IK07	
Color					Black	
Connector data QUICKON connection						
Core insulation	PVC/PE/TPE/rubber					
Structure of individual litz wire/smallest wire diameter	VDE 0295 class 1 to 6/min. 0.15 mm					
Connection frequency	max. 10					
Conductor cross section [mm ²] solid/stranded	0.5 mm ² ... 1.5 mm ² / 0.5 mm ² ... 1.5 mm ²				0.5 mm ² ... 1.5 mm ² / 0.5 mm ² ... 1.5 mm ²	
Conductor cross section [AWG]	20 ... 16				20 ... 16	
Temperature data						
Ambient temperature (operation)					-40 °C ... 80 °C	
Temperature when conductor connected					-5 °C ... 50 °C	

	Ordering data					
	2+PE-pos.		3+PE-pos.		4+PE-pos.	
Description	Order No.	Pcs. / Pkt.	Order No.	Pcs. / Pkt.	Order No.	Pcs. / Pkt.
T-distributor , for cable diameter:						
4 mm ... 9 mm	1414712	1	1414708	1		
8 mm ... 13 mm	1414714	1	1414710	1		
5 mm ... 10 mm					1414753	1
9 mm ... 14 mm					1414754	1
QUICKON nut , for connections up to 1.5 mm ² , for cable diameter:						
4 mm ... 9 mm					1415099	1
8 mm ... 13 mm					1415100	1
5 mm ... 10 mm						1415101
9 mm ... 14 mm						1415104

Installation system

1.5 mm² installation system

Cable connector, 0.14 mm² ... 1.5 mm²

new

- Easy cable extension or cable repairs
- The QUICKON connections feature different position markings and mechanical coding
- Touch-proof in accordance with DIN EN 50274



Unshielded



Shielded

ERC

	Technical data			Technical data		
	0.34 mm ²	0.75 mm ²	1.5 mm ²	4-pos.	5-pos.	8-pos.
General data						
Degree of protection		IP65 / IP67			IP65 / IP67	
Electrical data						
Rated voltage (III/3)	125 V	250 V	500 V	250 V	60 V	30 V
Rated surge voltage	2.5 kV	4 kV	6 kV		-	
Rated current	5 A	9 A	15 A		4 A	2 A
Surge voltage category/pollution degree		III / 3			II / 3	
Material data						
Housing material		PA		Zinc die-cast, surface bronzed, and nickel-plated		
Contact material		Steel			CuSn	
Contact surface material			Tin-plated		Ni/Au	
Inflammability class according to UL 94			V0		V0	
Impact category			IK06		-	
Connector data QUICKON connection						
Core insulation		PVC/PE		PVC / PE / PP / rubber		
Structure of individual litz wire/smallest wire diameter	VDE 0295 class 1 to 6 / min. 0.10 mm	VDE 0295 class 1 to 6/min. 0.15 mm		Class 2-6 / 0.1 mm		
Connection frequency		10		10		
Conductor cross section [mm ²] solid/stranded	0.14 mm ² ... 0.25 mm ² / 0.14 mm ² ... 0.34 mm ²	0.34 mm ² ... 0.5 mm ² / 0.34 mm ² ... 0.75 mm ²	0.75 mm ² ... 1 mm ² / 0.75 mm ² ... 1.5 mm ²	0.14 mm ² ... 0.75 mm ² / 0.14 mm ² ... 0.75 mm ²		0.14 mm ² ... 0.5 mm ² / 0.14 mm ² ... 0.5 mm ²
Conductor cross section [AWG]	26 ... 22	22 ... 18	18 ... 16	26 ... 18		26 ... 20
Temperature data						
Ambient temperature (operation)		-40 °C ... 80 °C		-40 °C ... 85 °C		
Temperature when conductor connected		-5 °C ... 50 °C		-5 °C ... 50 °C		
	Ordering data			Ordering data		
Description	Order No.	Pcs. / Pkt.	Order No.	Pcs. / Pkt.	Order No.	Pcs. / Pkt.
	0.34 mm ²		0.75 mm ²		1.5 mm ²	
Cable connector , for connecting round cables, cable diameter: 3.5 mm ... 6 mm, 4-pos. 4.0 mm ... 8 mm, 4-pos. 6 mm ... 12 mm, 4-pos. 6 mm ... 12 mm, 3+PE-pos.	1641879	1	1642140	1	1642153 1642182	1 1
Cable connector , shielded, color-coded terminal blocks, cable diameter: 5.0 mm ... 10.0 mm					1414418	1 1414417 1 1414612 1

**Cable connector,
1.5 mm²**

new

new

- Easy cable extension or cable repairs
- The QUICKON connections at opposite ends feature different position markings and mechanical coding
- The 1.5 mm² connector can be used here instead of the QUICKON nut
- Also available as gray color versions



With two QUICKON nuts



With one QUICKON nut

	Technical data					
	2+PE-pos.		3+PE-pos.		4+PE-pos.	
General data						
Degree of protection	IP68 / IP69K					
Electrical data						
Rated voltage (III/3)	690 V				690 V	
Rated surge voltage	6 kV				6 kV	
Rated current	17.5 A				17.5 A	
Surge voltage category/pollution degree	III / 3				III / 3	
Material data						
Housing material	PA				PA	
Contact material	Cu				Cu	
Contact surface material	Silver-plated				Silver-plated	
Inflammability class according to UL 94	V0				V0	
Impact category	IK07				IK07	
Color	Black				Black	
Connector data QUICKON connection						
Core insulation	PVC/PE/TPE/rubber					
Structure of individual litz wire/smallest wire diameter	VDE 0295 class 1 to 6/min. 0.15 mm					
Connection frequency	10					
Conductor cross section [mm ²] solid/stranded	0.5 mm ² ... 1.5 mm ² / 0.5 mm ² ... 1.5 mm ²				0.5 mm ² ... 1.5 mm ² / 0.5 mm ² ... 1.5 mm ²	
Conductor cross section [AWG]	20 ... 16				20 ... 16	
Temperature data						
Ambient temperature (operation)	-40 °C ... 80 °C				-40 °C ... 80 °C	
Temperature when conductor connected	-5 °C ... 50 °C				-5 °C ... 50 °C	
Description	Ordering data					
	Order No.	Pcs. / Pkt.	Order No.	Pcs. / Pkt.	Order No.	Pcs. / Pkt.
Cable connector , for cable diameter:	2+PE-pos.		3+PE-pos.		4+PE-pos.	
4 mm ... 9 mm	1414700	1	1414696	1	1414699	1
8 mm ... 13 mm	1414702	1	1414698	1	1414701	1
5 mm ... 10 mm						1414739
9 mm ... 14 mm					1414740	1
					1414742	1
QUICKON nut , for connections up to 1.5 mm ² , for cable diameter:	2+PE-pos.		3+PE-pos.		4+PE-pos.	
4 mm ... 9 mm					1415099	1
8 mm ... 13 mm					1415100	1
5 mm ... 10 mm					1415097	1
9 mm ... 14 mm					1415098	1
						1415101
						1415104

Installation system

1.5 mm² installation system

Panel feed-throughs, 1.5 mm²

- Devices no longer need to be opened in order to connect the cables
- User-friendly connection, even on devices that are difficult to access
- Touch-proof in accordance with DIN EN 50274



With litz wires



With manual solder/slip-on connection



Technical data

General data	
Degree of protection	IP65 / IP67
Electrical data	
Rated voltage (III/3)	500 V
Rated surge voltage	6 kV
Rated current	15 A
Surge voltage category/pollution degree	III / 3
Material data	
Housing material	PA
Contact material	CuZn
Contact surface material	Tin-plated
Inflammability class according to UL 94	V0
Impact category	IK07
Color	Black
Connector data QUICKON connection	
Core insulation	PVC/PE
Structure of individual litz wire/smallest wire diameter	VDE 0295 class 1 to 6/min. 0.15 mm
Connection frequency	10
Conductor cross section [mm ²] solid/stranded	0.75 mm ² ... 1 mm ² / 0.75 mm ² ... 1.5 mm ²
Conductor cross section [AWG]	18 ... 16
Temperature data	
Ambient temperature (operation)	-40 °C ... 80 °C
Temperature when conductor connected	-5 °C ... 50 °C

Ordering data

Description	Cable length	3+PE-pos.		4-pos.	
		Order No.	Pcs. / Pkt.	Order No.	Pcs. / Pkt.
Panel feed-through , with 1.5 mm ² litz wire, connecting thread: M20 x 1.5	0.1 m	1584787	10	1585045	10
	0.5 m				
Panel feed-through , with 4.8 mm x 0.8 mm manual solder/slip-on connection, connection thread: M20 x 1.5, color: black, terminal marking: L1, N, PE					
Panel feed-through , with 4.8 mm x 0.8 mm manual solder/slip-on connection, connecting thread: M20 x 1.5, color: black					
	0.05 m	1641659	10	1643000	10

Technical data

General data	
Degree of protection	IP65 / IP67
Electrical data	
Rated voltage (III/3)	500 V
Rated surge voltage	6 kV
Rated current	15 A
Surge voltage category/pollution degree	III / 3
Material data	
Housing material	PA
Contact material	CuZn
Contact surface material	Tin-plated
Inflammability class according to UL 94	V0
Impact category	IK07
Color	Black
Connector data QUICKON connection	
Core insulation	PVC/PE
Structure of individual litz wire/smallest wire diameter	VDE 0295 class 1 to 6/min. 0.15 mm
Connection frequency	10
Conductor cross section [mm ²] solid/stranded	0.75 mm ² ... 1 mm ² / 0.75 mm ² ... 1.5 mm ²
Conductor cross section [AWG]	18 ... 16
Temperature data	
Ambient temperature (operation)	-25 °C ... 80 °C
Temperature when conductor connected	-5 °C ... 50 °C

Ordering data

Description	Cable length	3-pos.		4-pos.	
		Order No.	Pcs. / Pkt.	Order No.	Pcs. / Pkt.
Panel feed-through , with 1.5 mm ² litz wire, connecting thread: M20 x 1.5	0.1 m	1584787	10	1585045	10
	0.5 m				
Panel feed-through , with 4.8 mm x 0.8 mm manual solder/slip-on connection, connection thread: M20 x 1.5, color: black, terminal marking: L1, N, PE					
Panel feed-through , with 4.8 mm x 0.8 mm manual solder/slip-on connection, connecting thread: M20 x 1.5, color: black					
	0.05 m	1641659	10	1643000	10

Panel feed-throughs, 1.5 mm², with litz wires

new

new

- Devices no longer need to be opened in order to connect the cables
- User-friendly connection, even on devices that are difficult to access
- Touch-proof in accordance with DIN EN 50274
- Also available as gray color versions



With QUICKON nut



Without QUICKON nut

	Technical data					
	2+PE-pos.		3+PE-pos.		4+PE-pos.	
General data						
Degree of protection	IP68 / IP69K					
Electrical data						
Rated voltage (III/3)	690 V			690 V		
Rated surge voltage	6 kV			6 kV		
Rated current	17.5 A			17.5 A		
Surge voltage category/pollution degree	III / 3			III / 3		
Material data						
Housing material	PA			PA		
Contact material	Cu			Cu		
Inflammability class according to UL 94	V0			V0		
Mechanical data						
Impact category	IK07			IK07		
Color	Black			Black		
Connector data QUICKON connection						
Core insulation	PVC/PE/TPE/rubber			PVC/PE/TPE/rubber		
Structure of individual litz wire/smallest wire diameter	VDE 0295 class 1 to 6/min. 0.15 mm			VDE 0295 class 1 to 6/min. 0.15 mm		
Connection frequency	max. 10			max. 10		
Conductor cross section [mm ²] solid/stranded	0.5 mm ² ... 1.5 mm ² / 0.5 mm ² ... 1.5 mm ²			0.5 mm ² ... 1.5 mm ² / 0.5 mm ² ... 1.5 mm ²		
Conductor cross section [AWG]	20 ... 16			20 ... 16		
Temperature data						
Ambient temperature (operation)	-40 °C ... 80 °C			-40 °C ... 80 °C		
Temperature when conductor connected	-5 °C ... 50 °C			-5 °C ... 50 °C		

	Ordering data						
	2+PE-pos.		3+PE-pos.		4+PE-pos.		
Description	Cable length	Order No.	Pcs. / Pkt.	Order No.	Pcs. / Pkt.	Order No.	Pcs. / Pkt.
Panel feed-through, with M20 x 1.5 mounting flange, with QUICKON nut, for cable diameter:							
4 mm ... 9 mm	0.5 m	1414684	1	1414675	1		
4 mm ... 9 mm	1 m	1414685	1	1414676	1		
8 mm ... 13 mm	0.5 m	1414687	1	1414678	1		
8 mm ... 13 mm	1 m	1414688	1	1414679	1		
Panel feed-through, with M25 x 1.5 mounting flange, with QUICKON nut, for cable diameters:							
5 mm ... 10 mm	0.5 m			1414730	1		
5 mm ... 10 mm	1 m			1414731	1		
9 mm ... 14 mm	0.5 m			1414733	1		
9 mm ... 14 mm	1 m			1414734	1		
Panel feed-through, with M20 x 1.5 mounting flange, without QUICKON nut							
	0.5 m					1414690	1
	1 m					1414691	1
Panel feed-through, with M25 x 1.5 mounting flange, without QUICKON nut							
	0.5 m						1414736
	1 m						1414737
QUICKON nut, for connections up to 1.5 mm², for cable diameter:							
4 mm ... 9 mm						1415099	1
8 mm ... 13 mm						1415100	1
5 mm ... 10 mm							1415101
9 mm ... 14 mm							1415104

Installation system

1.5 mm² installation system

Panel feed-throughs, 1.5 mm², with manual solder/slip-on connection

- Devices no longer need to be opened in order to connect the cables
- User-friendly connection, even on devices that are difficult to access
- Also available as gray color versions
- Touch-proof in accordance with DIN EN 50274

new

new



With QUICKON nut



Without QUICKON nut

	Technical data			Technical data			
	2+PE-pos.	3+PE-pos.	4+PE-pos.	2+PE-pos.	3+PE-pos.	4+PE-pos.	
General data							
Degree of protection		IP68 / IP69K			IP68 / IP69K		
Electrical data							
Rated voltage (III/3)		690 V			690 V		
Rated surge voltage		6 kV			6 kV		
Rated current		17.5 A			17.5 A		
Surge voltage category/pollution degree		III / 3			III / 3		
Material data							
Housing material		PA			PA		
Contact material		Cu			Cu		
Inflammability class according to UL 94		V0			V0		
Mechanical data							
Impact category		IK07			IK07		
Color		Black			Black		
Connector data QUICKON connection							
Core insulation		PVC/PE/TPE/rubber			PVC/PE/TPE/rubber		
Structure of individual litz wire/smallest wire diameter		VDE 0295 class 1 to 6/min. 0.15 mm			VDE 0295 class 1 to 6/min. 0.15 mm		
Connection frequency		max. 10			max. 10		
Conductor cross section [mm ²] solid/stranded		0.5 mm ² ... 1.5 mm ² / 0.5 mm ² ... 1.5 mm ²			0.5 mm ² ... 1.5 mm ² / 0.5 mm ² ... 1.5 mm ²		
Conductor cross section [AWG]		20 ... 16			20 ... 16		
Temperature data							
Ambient temperature (operation)		-40 °C ... 80 °C			-40 °C ... 80 °C		
Temperature when conductor connected		-5 °C ... 50 °C			-5 °C ... 50 °C		
	Ordering data			Ordering data			
Description	Order No.	Pcs. / Pkt.	Order No.	Pcs. / Pkt.	Order No.	Pcs. / Pkt.	
	2+PE-pos.		3+PE-pos.		4+PE-pos.		
Panel feed-through , with M20 x 1.5 mounting flange, with QUICKON nut , for cable diameter:							
4 mm ... 9 mm	1414686	1	1414677	1			
8 mm ... 13 mm	1414689	1	1414680	1			
Panel feed-through , with M25 x 1.5 mounting flange, with QUICKON nut , for cable diameters:							
5 mm ... 10 mm					1414732	1	
9 mm ... 14 mm					1414735	1	
Panel feed-through , with M20 x 1.5 mounting flange, without QUICKON nut							
					1414692	1	
					1414683	1	
Panel feed-through , with M25 x 1.5 mounting flange, without QUICKON nut							
						1414738	1
QUICKON nut , for connections up to 1.5 mm ² , for cable diameter:							
4 mm ... 9 mm					1415099	1	
8 mm ... 13 mm					1415100	1	
5 mm ... 10 mm						1415101	1
9 mm ... 14 mm						1415104	1

Connector, 1.5 mm²

new

- With capacitive PE contact
- Compatible with QUICKON connection
- Can be coded using the two red coding profiles to prevent incorrect connection of similar connectors
- Touch-proof in accordance with DIN EN 50274
- Also available as gray color versions
- With SPEEDCON fast locking system



Technical data			
	2+PE-pos.	3+PE-pos.	4+PE-pos.
General data			
Degree of protection		IP68 / IP69K	
Electrical data			
Rated voltage (III/3)		690 V	
Rated surge voltage		6 kV	
Rated current		17.5 A	
Surge voltage category/pollution degree		III / 3	
Material data			
Housing material		PA	
Contact material		Cu	
Contact surface material		Silver-plated	
Inflammability class according to UL 94		V0	
Impact category		IK07	
Color		Black	
Connector data QUICKON connection			
Core insulation		PVC/PE/TPE/rubber	
Structure of individual litz wire/smallest wire diameter		VDE 0295 class 1 to 6/min. 0.15 mm	
Connection frequency		10	
Conductor cross section [mm ²] solid/stranded		0.5 mm ² ... 1.5 mm ² / 0.5 mm ² ... 1.5 mm ²	
Conductor cross section [AWG]		20 ... 16	
Temperature data			
Ambient temperature (operation)		-40 °C ... 80 °C	
Temperature when conductor connected		-5 °C ... 50 °C	

Ordering data						
Description	Order No.	Pcs. / Pkt.	Order No.	Pcs. / Pkt.	Order No.	Pcs. / Pkt.
	2+PE-pos.		3+PE-pos.		4+PE-pos.	
Connectors , for cable diameters:						
4 mm ... 9 mm	1414705	1	1414703	1		
8 mm ... 13 mm	1414706	1	1414704	1		
5 mm ... 10 mm					1414749	1
9 mm ... 14 mm					1414750	1

Installation system

1.5 mm² installation system

Accessories

- Plastic labels ③ can be stuck to the middle of the H-distributor
- Red sealing plugs ④ can be easily stuck into the QUICKON nuts and create a seal when screwed tight
- Protective caps with retaining cords ⑤ for closing open QUICKON domes which are going to have a connector (for example) fitted at a later date
- Locking nuts ⑥ for fixing the panel feed-throughs to thin panels that are unable to accommodate a proprietary thread
- Insulating sleeve ⑦ for 4.8 mm slip-on connections
- Transparent protective caps ⑧ for attaching to the open QUICKON dome
- Transparent protective caps ⑨ at front for attaching to the connector
- Slotted socket wrenches ⑩ enable you to tighten the QUICKON nuts easily and securely
- Red coding profiles ⑪ for preventing QPD connector mix-ups. Simply insert them into the QUICKON dome and connector on the front side. They are marked with an arrow and their symmetrical form enables them to be mounted in four different positions
- Aluminum shielding tape ⑬ prevents the splicing of the braided shield and enables a clean shield connection



Ordering data			
Description	Type	Order No.	Pcs. / Pkt.
Plastic label ③ For plotting and engraving Can be printed using thermal transfer printer	GPE 13X 9 WH EMLP (13X9)R	0806932 0819453	10 1
Closing cap , for closing unused bore holes in multiple seals and cable glands ④ Ø 10 mm Ø 14 mm	SEALING PLUG 10X16 RD SEALING PLUG 14X22 RD	1400284 1400270	10 10
Protective cap , captive, IP68 ⑤ Color: gray Color: gray	QPD QSK BK 3/4X1,5 FS QPD QSK BK 5X1,5 FS	1414722 1414728	1 1
Counter nut , (plastic), to lock the contact carrier from the inside of the device ⑥ M20/SW26/color: green M25 /SW32/color: black	Q-MU M20 Q-MU M25	1640702 1640715	25 25
Insulating sleeve , as shock protection for 4.8 mm slip-on sleeves; first slide over the conductor For 4.8 mm slip-on sleeves ⑦	PT/FS 4,8	1670497	25
Protective cap , transparent plastic, for QUICKON connection, IP54 ⑧	QPD QSK 3/4X1,5 QPD QSK 5X1,5	1414723 1414758	10 10
Protective cap , transparent plastic, for QUICKON connection, IP50 ⑨	QPD PSK 3/4X1,5 QPD PSK 5X1,5	1414724 1414759	10 10
Slotted socket wrench for QUICKON nuts and panel feed-throughs, for wrench size: ⑩ 15 mm 19 mm 22 mm	QSS 15 QSS 19 QSS 22	1641992 1670895 1670206	1 1 1
Coding profile , for insertion into the connector and QUICKON dome ⑪	CP-QPD 3/4X1,5 CP-QPD 5X1,5	1414729 1414760	10 10
Shielding tape , for shielded QPD versions ⑬	ALU-SB	1404531	100

H-distributor, 2.5 mm²

- Can be used as a H-distributor with continuous master cable
- Can be used as a star distributor
- Can be used as a Y-distributor with a test connection
- Touch-proof in accordance with DIN EN 50274
- Also available as gray color versions



With four QUICKON nuts



Without QUICKON nut



Technical data

	3+PE-pos.	4+PE-pos.
General data		
Degree of protection	IP68 / IP69K	
Electrical data		
Rated voltage (III/3)	690 V	
Rated surge voltage	6 kV	
Rated current	20 A	
Surge voltage category/pollution degree	III / 3	
Material data		
Housing material	PA	
Contact material	Cu	
Inflammability class according to UL 94	V0	
Mechanical data		
Impact category	IK07	
Color	Black	
Connector data QUICKON connection		
Core insulation	PVC/PE/TPE/rubber	
Structure of individual litz wire/smallest wire diameter	VDE 0295 class 1 to 6/min. 0.15 mm	
Connection frequency	max. 10	
Conductor cross section [mm ²] solid/stranded	1 mm ² ... 2.5 mm ² / 1 mm ² ... 2.5 mm ²	
Conductor cross section [AWG]	16 ... 14	
Temperature data		
Ambient temperature (operation)	-40 °C ... 80 °C	
Temperature when conductor connected	-5 °C ... 50 °C	



Technical data

	3+PE-pos.	4+PE-pos.
General data		
Degree of protection	IP68 / IP69K	
Electrical data		
Rated voltage (III/3)	690 V	
Rated surge voltage	6 kV	
Rated current	20 A	
Surge voltage category/pollution degree	III / 3	
Material data		
Housing material	PA	
Contact material	Cu	
Inflammability class according to UL 94	V0	
Mechanical data		
Impact category	IK07	
Color	Black	
Connector data QUICKON connection		
Core insulation	PVC/PE/TPE/rubber	
Structure of individual litz wire/smallest wire diameter	VDE 0295 class 1 to 6/min. 0.15 mm	
Connection frequency	max. 10	
Conductor cross section [mm ²] solid/stranded	1 mm ² ... 2.5 mm ² / 1 mm ² ... 2.5 mm ²	
Conductor cross section [AWG]	16 ... 14	
Temperature data		
Ambient temperature (operation)	-40 °C ... 80 °C	
Temperature when conductor connected	-5 °C ... 50 °C	

Ordering data

Description	Order No.	Pcs. / Pkt.	Order No.	Pcs. / Pkt.
	3+PE-pos.		4+PE-pos.	
H-distributor, with four QUICKON nuts and one sealing bolt, for cable diameters:				
6 mm ... 10 mm	1582145	1		
9 mm ... 14 mm	1582148	1		
6 mm ... 11 mm			1406368	1
9 mm ... 16 mm			1406369	1
H-distributor, without QUICKON nuts				
QUICKON nut, for connections up to 2.5 mm², for cable diameters:				
6 mm ... 10 mm				
9 mm ... 14 mm				
6 mm ... 11 mm				
9 mm ... 16 mm				

Ordering data

Order No.	Pcs. / Pkt.	Order No.	Pcs. / Pkt.
1582154	1	1406370	1
1582226	1		
1582229	1		
		1459663	1
		1459647	1

Installation system

2.5 mm² installation system

T-distributor, 2.5 mm²

- Can be used as a T-distributor with continuous master cable
- Touch-proof in accordance with DIN EN 50274
- Also available as gray color versions



With three QUICKON nuts



With two QUICKON nuts



Technical data

4+PE-pos.

General data	
Degree of protection	IP68 / IP69K
Electrical data	
Rated voltage (III/3)	690 V
Rated surge voltage	6 kV
Rated current	20 A
Surge voltage category/pollution degree	III / 3
Material data	
Housing material	PA
Contact material	Cu
Inflammability class according to UL 94	V0
Mechanical data	
Impact category	IK07
Color	Black
Connector data QUICKON connection	
Core insulation	PVC/PE/TPE/rubber
Structure of individual litz wire/smallest wire diameter	VDE 0295 class 1 to 6/min. 0.15 mm
Connection frequency	max. 10
Conductor cross section [mm ²] solid/stranded	1 mm ² ... 2.5 mm ² / 1 mm ² ... 2.5 mm ²
Conductor cross section [AWG]	16 ... 14
Temperature data	
Ambient temperature (operation)	-40 °C ... 80 °C
Temperature when conductor connected	-5 °C ... 50 °C

IP68 / IP69K
690 V
6 kV
20 A
III / 3
PA
Cu
V0
IK07
Black
PVC/PE/TPE/rubber
VDE 0295 class 1 to 6/min. 0.15 mm
max. 10
1 mm ² ... 2.5 mm ² / 1 mm ² ... 2.5 mm ²
16 ... 14
-40 °C ... 80 °C
-5 °C ... 50 °C

Technical data

4+PE-pos.

IP68 / IP69K
690 V
6 kV
20 A
III / 3
PA
Cu
V0
IK07
Black
PVC/PE/TPE/rubber
VDE 0295 class 1 to 6/min. 0.15 mm
max. 10
1 mm ² ... 2.5 mm ² / 1 mm ² ... 2.5 mm ²
16 ... 14
-40 °C ... 80 °C
-5 °C ... 50 °C

Ordering data

Description
T-distributor , for cable diameter: 6 mm ... 11 mm 9 mm ... 16 mm
QUICKON nut , for connections up to 2.5 mm ² , for cable diameters: 6 mm ... 11 mm 9 mm ... 16 mm

Type	Order No.	Pcs. / Pkt.
QPD T 4PE 3X6-11 BK	1405401	1
QPD T 4PE 3X9-16 BK	1405402	1

Ordering data

Type	Order No.	Pcs. / Pkt.
QPD T 4PE 2X6-11 BK	1405403	1
QPD T 4PE 2X9-16 BK	1405404	1
QPD N 4PE2,5 6-11 BK	1459663	1
QPD N 4PE2,5 9-16 BK	1459647	1

Cable connector, 2.5 mm²

- Easy cable extension or cable repairs
- The QUICKON connections at opposite ends feature different position markings and mechanical coding
- The 2.5 mm² connector can be used here instead of the QUICKON nut
- Also available as gray color versions



With two QUICKON nuts



With one QUICKON nut



Technical data	
	3+PE-pos.
General data	
Degree of protection	IP68 / IP69K
Electrical data	
Rated voltage (III/3)	690 V
Rated surge voltage	6 kV
Rated current	20 A
Surge voltage category/pollution degree	III / 3
Material data	
Housing material	PA
Contact material	Cu
Contact surface material	Silver-plated
Inflammability class according to UL 94	V0
Impact category	IK07
Color	Black
Connector data QUICKON connection	
Core insulation	PVC/PE/TPE/rubber
Structure of individual litz wire/smallest wire diameter	VDE 0295 class 1 to 6/min. 0.15 mm
Connection frequency	10
Conductor cross section [mm ²] solid/stranded	1 mm ² ... 2.5 mm ² / 1 mm ² ... 2.5 mm ²
Conductor cross section [AWG]	16 ... 14
Temperature data	
Ambient temperature (operation)	-40 °C ... 80 °C
Temperature when conductor connected	-5 °C ... 50 °C



Technical data	
	3+PE-pos.
General data	
Degree of protection	IP68 / IP69K
Electrical data	
Rated voltage (III/3)	690 V
Rated surge voltage	6 kV
Rated current	20 A
Surge voltage category/pollution degree	III / 3
Material data	
Housing material	PA
Contact material	Cu
Contact surface material	Silver-plated
Inflammability class according to UL 94	V0
Impact category	IK07
Color	Black
Connector data QUICKON connection	
Core insulation	PVC/PE/TPE/rubber
Structure of individual litz wire/smallest wire diameter	VDE 0295 class 1 to 6/min. 0.15 mm
Connection frequency	10
Conductor cross section [mm ²] solid/stranded	1 mm ² ... 2.5 mm ² / 1 mm ² ... 2.5 mm ²
Conductor cross section [AWG]	16 ... 14
Temperature data	
Ambient temperature (operation)	-40 °C ... 80 °C
Temperature when conductor connected	-5 °C ... 50 °C

Ordering data			
Description	Order No.	Pcs. / Pkt.	Order No.
	3+PE-pos.		4+PE-pos.
Cable connector , for cable diameter:			
6 mm ... 10 mm	1582211	1	
9 mm ... 14 mm	1582214	1	
6 mm ... 11 mm			1403838
9 mm ... 16 mm			1403836
QUICKON nut , for connections up to 2.5 mm ² , for cable diameters:			
6 mm ... 10 mm			
9 mm ... 14 mm			
6 mm ... 11 mm			
9 mm ... 16 mm			

Ordering data			
Description	Order No.	Pcs. / Pkt.	Order No.
	3+PE-pos.		4+PE-pos.
Cable connector , for cable diameter:			
6 mm ... 10 mm	1582220	1	
9 mm ... 14 mm	1582223	1	
6 mm ... 11 mm			1403834
9 mm ... 16 mm			1403831
QUICKON nut , for connections up to 2.5 mm ² , for cable diameters:			
6 mm ... 10 mm	1582226	1	
9 mm ... 14 mm	1582229	1	
6 mm ... 11 mm			1459663
9 mm ... 16 mm			1459647

Installation system

2.5 mm² installation system

Panel feed-throughs, 2.5 mm², with litz wires

- Devices no longer need to be opened in order to connect the cables
- User-friendly connection, even on devices that are difficult to access
- Touch-proof in accordance with DIN EN 50274
- Also available as gray color versions



With QUICKON nut



Without QUICKON nut



Technical data

	3+PE-pos.	4+PE-pos.
General data		
Degree of protection	IP68 / IP69K	
Electrical data		
Rated voltage (III/3)	690 V	
Rated surge voltage	6 kV	
Rated current	20 A	
Surge voltage category/pollution degree	III / 3	
Material data		
Housing material	PA	
Contact material	Cu	
Inflammability class according to UL 94	V0	
Mechanical data		
Impact category	IK07	
Color	Black	
Connector data QUICKON connection		
Core insulation	PVC/PE/TPE/rubber	
Structure of individual litz wire/smallest wire diameter	VDE 0295 class 1 to 6/min. 0.15 mm	
Connection frequency	max. 10	
Conductor cross section [mm ²] solid/stranded	1 mm ² ... 2.5 mm ² / 1 mm ² ... 2.5 mm ²	
Conductor cross section [AWG]	16 ... 14	
Temperature data		
Ambient temperature (operation)	-40 °C ... 80 °C	
Temperature when conductor connected	-5 °C ... 50 °C	

Technical data

	3+PE-pos.	4+PE-pos.
General data		
Degree of protection	IP68 / IP69K	
Electrical data		
Rated voltage (III/3)	690 V	
Rated surge voltage	6 kV	
Rated current	20 A	
Surge voltage category/pollution degree	III / 3	
Material data		
Housing material	PA	
Contact material	Cu	
Inflammability class according to UL 94	V0	
Mechanical data		
Impact category	IK07	
Color	Black	
Connector data QUICKON connection		
Core insulation	PVC/PE/TPE/rubber	
Structure of individual litz wire/smallest wire diameter	VDE 0295 class 1 to 6/min. 0.15 mm	
Connection frequency	max. 10	
Conductor cross section [mm ²] solid/stranded	1 mm ² ... 2.5 mm ² / 1 mm ² ... 2.5 mm ²	
Conductor cross section [AWG]	16 ... 14	
Temperature data		
Ambient temperature (operation)	-40 °C ... 80 °C	
Temperature when conductor connected	-5 °C ... 50 °C	

Ordering data

Description	Cable length	3+PE-pos.		4+PE-pos.	
		Order No.	Pcs. / Pkt.	Order No.	Pcs. / Pkt.
Panel feed-through, I_N=15 A, with M20 x 1.5 mounting flange, with QUICKON nut, for cable diameters:					
6 mm ... 11 mm	0.5 m			1403725	1
6 mm ... 11 mm	1 m			1403727	1
9 mm ... 16 mm	0.5 m			1403731	1
9 mm ... 16 mm	1 m			1403733	1
Panel feed-through, with M25 x 1.5 mounting flange, with QUICKON nut, for cable diameters:					
6 mm ... 10 mm	0.5 m	1582163	1		
6 mm ... 10 mm	1 m	1582160	1		
9 mm ... 14 mm	0.5 m	1582175	1		
9 mm ... 14 mm	1 m	1582172	1		
6 mm ... 11 mm	0.5 m			1582557	1
6 mm ... 11 mm	1 m			1582558	1
9 mm ... 16 mm	0.5 m			1582561	1
9 mm ... 16 mm	1 m			1582562	1
Panel feed-through, with M20 x 1.5 mounting flange, without QUICKON nut					
	0.5 m				1403737
	1 m				1403739
Panel feed-through, with M25 x 1.5 mounting flange, without QUICKON nut					
	0.5 m			1582187	1
	1 m			1582190	1
QUICKON nut, for connections up to 2.5 mm², for cable diameters:					
6 mm ... 10 mm				1582226	1
9 mm ... 14 mm				1582229	1
6 mm ... 11 mm					1459663
9 mm ... 16 mm					1459647

Ordering data

Description	Cable length	3+PE-pos.		4+PE-pos.	
		Order No.	Pcs. / Pkt.	Order No.	Pcs. / Pkt.
Panel feed-through, I_N=15 A, with M20 x 1.5 mounting flange, without QUICKON nut					
	0.5 m				1403737
	1 m				1403739
Panel feed-through, with M25 x 1.5 mounting flange, without QUICKON nut					
	0.5 m			1582187	1
	1 m			1582190	1
QUICKON nut, for connections up to 2.5 mm², for cable diameters:					
6 mm ... 10 mm				1582226	1
9 mm ... 14 mm				1582229	1
6 mm ... 11 mm					1459663
9 mm ... 16 mm					1459647

Panel feed-throughs, 2.5 mm², with manual solder/slip-on connection

- Devices no longer need to be opened in order to connect the cables
- User-friendly connection, even on devices that are difficult to access
- Also available as gray color versions



With QUICKON nut



Without QUICKON nut



Technical data	
3+PE-pos.	4+PE-pos.
Degree of protection IP68 / IP69K	
Rated voltage (III/3) 690 V	
Rated surge voltage 6 kV	
Rated current 20 A	15 A
Surge voltage category/pollution degree III / 3	
Housing material PA	
Contact material Cu	
Inflammability class according to UL 94 V0	
Impact category IK07	
Color Black	
Core insulation PVC/PE/TPE/rubber	
Structure of individual litz wire/smallest wire diameter VDE 0295 class 1 to 6/min. 0.15 mm	
Connection frequency max. 10	
Conductor cross section [mm ²] solid/stranded 1 mm ² ... 2.5 mm ² / 1 mm ² ... 2.5 mm ²	
Conductor cross section [AWG] 16 ... 14	
Ambient temperature (operation) -40 °C ... 80 °C	
Temperature when conductor connected -5 °C ... 50 °C	



Technical data	
3+PE-pos.	4+PE-pos.
Degree of protection IP68 / IP69K	
Rated voltage (III/3) 690 V	
Rated surge voltage 6 kV	
Rated current 20 A	15 A
Surge voltage category/pollution degree III / 3	
Housing material PA	
Contact material Cu	
Inflammability class according to UL 94 V0	
Impact category IK07	
Color Black	
Core insulation PVC/PE/TPE/rubber	
Structure of individual litz wire/smallest wire diameter VDE 0295 class 1 to 6/min. 0.15 mm	
Connection frequency max. 10	
Conductor cross section [mm ²] solid/stranded 1 mm ² ... 2.5 mm ² / 1 mm ² ... 2.5 mm ²	
Conductor cross section [AWG] 16 ... 14	
Ambient temperature (operation) -40 °C ... 80 °C	
Temperature when conductor connected -5 °C ... 50 °C	

Ordering data					
Description	Order No.	Pcs. / Pkt.	Order No.	Pcs. / Pkt.	
	3+PE-pos.		4+PE-pos.		
Panel feed-through, I_N=15 A, with M20 x 1.5 mounting flange, with QUICKON nut, for cable diameters:					
6 mm ... 11 mm			1403729	1	
9 mm ... 16 mm			1403735	1	
Panel feed-through, with M25 x 1.5 mounting flange, with QUICKON nut, for cable diameters:					
6 mm ... 10 mm	1582166	1			
9 mm ... 14 mm	1582178	1			
6 mm ... 11 mm			1582559	1	
9 mm ... 16 mm			1582563	1	
Panel feed-through, with mounting flange, without QUICKON nut, connecting thread: M20, I_N=15 A				1403741	1
Panel feed-through, with M25 x 1.5 mounting flange, without QUICKON nut					
M25, I _N =20 A			1582196	1	
QUICKON nut, for connections up to 2.5 mm², for cable diameters:					
6 mm ... 10 mm			1582226	1	
9 mm ... 14 mm			1582229	1	
6 mm ... 11 mm				1459663	1
9 mm ... 16 mm				1459647	1

Ordering data				
Description	Order No.	Pcs. / Pkt.	Order No.	Pcs. / Pkt.
	3+PE-pos.		4+PE-pos.	
Panel feed-through, I_N=15 A, with M20 x 1.5 mounting flange, without QUICKON nut, for cable diameters:				
6 mm ... 11 mm				
9 mm ... 16 mm				
Panel feed-through, with M25 x 1.5 mounting flange, without QUICKON nut				
M25, I _N =20 A				
QUICKON nut, for connections up to 2.5 mm², for cable diameters:				
6 mm ... 10 mm				
9 mm ... 14 mm				
6 mm ... 11 mm				
9 mm ... 16 mm				

Installation system

2.5 mm² installation system

Panel feed-throughs, 2.5 mm², with push-in connection

- Devices no longer need to be opened in order to connect the cables
- User-friendly connection, even on devices that are difficult to access
- For internal push-in connection, solid conductors are simply stripped and inserted in the connection
- Touch-proof in accordance with DIN EN 50274
- Also available as gray color versions



With QUICKON nut



Without QUICKON nut



Technical data

Technical data

	3+PE-pos.	4+PE-pos.	3+PE-pos.	
General data				
Degree of protection	IP68 / IP69K		IP68 / IP69K	
Electrical data				
Rated voltage (III/3)	690 V		690 V	
Rated surge voltage	6 kV		6 kV	
Rated current	20 A		20 A	
Surge voltage category/pollution degree	III / 3		III / 3	
Material data				
Housing material	PA		PA	
Contact material	Cu		Cu	
Inflammability class according to UL 94	V0		V0	
Mechanical data				
Impact category	IK07		IK07	
Color	Black		Black	
Connector data QUICKON connection				
Core insulation	PVC/PE/rubber/TPE		PVC/PE/rubber/TPE	
Structure of individual litz wire/smallest wire diameter	VDE 0295 class 1 to 6/ min. 0.15 mm		VDE 0295 class 1 to 6/ min. 0.15 mm	
Connection frequency	max. 10		max. 10	
Conductor cross section [mm ²] solid/stranded	1 mm ² ... 2.5 mm ² / 1 mm ² ... 2.5 mm ²		1 mm ² ... 2.5 mm ² / 1 mm ² ... 2.5 mm ²	
Conductor cross section [AWG]	16 ... 14		16 ... 14	
Temperature data				
Ambient temperature (operation)	-40 °C ... 80 °C		-40 °C ... 80 °C	
Temperature when conductor connected	-5 °C ... 50 °C		-5 °C ... 50 °C	

Ordering data

Ordering data

Description	3+PE-pos.		4+PE-pos.		3+PE-pos.			
	Order No.	Pcs. / Pkt.	Order No.	Pcs. / Pkt.	Order No.	Pcs. / Pkt.	Order No.	Pcs. / Pkt.
Panel feed-through , with M25 x 1.5 mounting flange, with QUICKON nut, for cable diameters:								
6 mm ... 10 mm	1582169	1						
9 mm ... 14 mm	1582181	1						
6 mm ... 11 mm			1411432	1				
9 mm ... 16 mm			1411433	1				
Panel feed-through , with M25 x 1.5 mounting flange, without QUICKON nut					1582193	1		
QUICKON nut , for connections up to 2.5 mm ² , for cable diameters:								
6 mm ... 10 mm					1582226	1		
9 mm ... 14 mm					1582229	1		

Connector, 2.5 mm²

- With capacitive PE contact
- Compatible with QUICKON connection
- Can be coded using the two red coding profiles to prevent incorrect connection of similar connectors
- Touch-proof in accordance with DIN EN 50274
- Also available as gray color versions
- 5-pos. version with SPEEDCON fast locking system, cannot be released manually



With green screw locking



With black and gray screw locking



Technical data	
3+PE-pos.	
General data	
Degree of protection	IP68 / IP69K
Electrical data	
Rated voltage (III/3)	690 V
Rated surge voltage	6 kV
Rated current	20 A
Surge voltage category/pollution degree	III / 3
Material data	
Housing material	PA
Contact material	Cu
Contact surface material	Silver-plated
Inflammability class according to UL 94	V0
Impact category	IK07
Color	Black
Connector data QUICKON connection	
Core insulation	PVC/PE/TPE/rubber
Structure of individual litz wire/smallest wire diameter	VDE 0295 class 1 to 6/ min. 0.15 mm
Connection frequency	10
Conductor cross section [mm ²] solid/stranded	1 mm ² ... 2.5 mm ² / 1 mm ² ... 2.5 mm ²
Conductor cross section [AWG]	16 ... 14
Temperature data	
Ambient temperature (operation)	-40 °C ... 80 °C
Temperature when conductor connected	-5 °C ... 50 °C

Ordering data			
Description	3+PE-pos.		Order No.
	Order No.	Pcs. / Pkt.	
Connectors , for cable diameters:			
6 mm ... 10 mm	1582202	1	
9 mm ... 14 mm	1582205	1	



Technical data	
3+PE-pos.	4+PE-pos.
General data	
Degree of protection	IP68 / IP69K
Electrical data	
Rated voltage (III/3)	690 V
Rated surge voltage	6 kV
Rated current	20 A
Surge voltage category/pollution degree	III / 3
Material data	
Housing material	PA
Contact material	Cu
Contact surface material	Silver-plated
Inflammability class according to UL 94	V0
Impact category	IK07
Color	Black
Connector data QUICKON connection	
Core insulation	PVC/PE/TPE/rubber
Structure of individual litz wire/smallest wire diameter	VDE 0295 class 1 to 6/ min. 0.15 mm
Connection frequency	10
Conductor cross section [mm ²] solid/stranded	1 mm ² ... 2.5 mm ² / 1 mm ² ... 2.5 mm ²
Conductor cross section [AWG]	16 ... 14
Temperature data	
Ambient temperature (operation)	-40 °C ... 80 °C
Temperature when conductor connected	-5 °C ... 50 °C

Ordering data				
Description	3+PE-pos.		4+PE-pos.	
	Order No.	Pcs. / Pkt.	Order No.	Pcs. / Pkt.
Connectors , for cable diameters:				
6 mm ... 10 mm	1582637	1		
9 mm ... 14 mm	1582638	1		
6 mm ... 11 mm			1403784	1
9 mm ... 16 mm			1403782	1

Installation system

2.5 mm² installation system

Accessories

- Mounting clip ① for easily fixing the H-distributor in place without the need for tools
- DIN rail mounting can be achieved using two DIN-rail adapters ②
- Plastic labels ③ can be stuck to the middle of the H-distributor
- Red sealing plugs ④ can be easily stuck into the QUICKON nuts and create a seal when screwed tight
- Protective caps with retaining cords ⑤ for closing open QUICKON domes which are going to have a connector (for example) fitted at a later date
- Locking nuts ⑥ for fixing the panel feed-throughs to thin panels that are unable to accommodate a proprietary thread
- Insulating sleeve ⑦ for 4.8 mm slip-on connections
- Transparent protective caps ⑧ for attaching to the open QUICKON dome
- Transparent protective caps ⑨ at front for attaching to the connector
- Slotted socket wrenches ⑩ enable you to tighten the QUICKON nuts easily and securely
- Red coding profiles ⑪ for preventing QPD connector mix-ups. Simply insert them into the QUICKON dome and connector on the front side. They are marked with an arrow and their symmetrical form enables them to be mounted in four different positions
- AS-Interface seals ⑫ for connecting 1 or 2 AS-Interface cables
- Aluminum shielding tape ⑬ prevents the splicing of the braided shield and enables a clean shield connection



Description		Ordering data		
Type	Order No.	Pcs. / Pkt.		
Mounting clip , for H-distributor ①	QPD CLIP 2,5 BK	1582235	10	
DIN rail adapter ② For M5 screws	USA 10/4,6	1202713	10	
Plastic label ③ For plotting and engraving Can be printed using thermal transfer printer	GPE 13X 9 WH EMLP (13X9)R	0806932 0819453	10	1
Closing cap , for closing unused bore holes in multiple seals and cable glands ④				
Ø 10 mm	SEALING PLUG 10X16 RD	1400284	10	
Ø 14 mm	SEALING PLUG 14X22 RD	1400270	10	
Protective cap , captive, IP68 ⑤ Color: green Color: black Color: gray Color: black	QPD QSK 2,5 FS QPD QSK BK 2,5 FS QPD QSK GY 5X2,5 FS QPD QSK BK 5X2,5 FS	1582488 1582645 1404526 1404525	1	1
Counter nut , (plastic), ⑥ to lock the contact carrier from the inside of the device				
M16 / SW22 / color: green	Q-MU M16	1640692	25	
M20 / SW26 / color: green	Q-MU M20	1640702	25	
M25 / SW32 / color: black	Q-MU M25	1640715	25	
Pg21 / SW36 / color: black	Q-MU PG 21 BK	1582655	50	
Insulating sleeve , ⑦ as shock protection for 4.8 mm slip-on sleeves; first slide over the conductor For 4.8 mm slip-on sleeves				
Protective cap , transparent plastic, for QUICKON connection, IP54 ⑧	PT/FS 4,8	1670497	25	
Protective cap , transparent plastic, for QUICKON connection, IP50 ⑨	QPD QSK 2,5 QPD QSK 5X2,5 QPD QSK 5X6,0	1582150 1404528 1411403	10	10
Slotted socket wrench for QUICKON nuts and panel feed-throughs, for wrench size: ⑩	QPD PSK 2,5 QPD PSK 5X2,5 QPD PSK 5X6,0	1582151 1404529 1411404	10	10
15 mm	QSS 15	1641992	1	
19 mm	QSS 19	1670895	1	
22 mm	QSS 22	1670206	1	
24 mm	QSS 24	1670219	1	
27 mm	QSS 27	1670646	1	
Coding profile , for insertion into the connector and QUICKON dome ⑪	CP-QPD CP-QPD 5X2,5	1582459 1404530	10	10
Seal for 4-pos. versions , NBR, black, for IP65/IP67 protection ⑫				
One AS-i cable	KV-DI-PG16-1XASI	1582462	10	
Two AS-i cables	KV-DI-PG16-2XASI	1582464	10	
Shielding tape , for shielded QPD versions ⑬	ALU-SB	1404531	100	

H-distributor, 6.0 mm²

- Can be used as a H-distributor with continuous master cable
- Can be used as a star distributor
- Can be used as a Y-distributor with a test connection
- Touch-proof in accordance with DIN EN 50274
- Also available as gray color versions



With four QUICKON nuts



Without QUICKON nut

Technical data	
4+PE-pos.	
General data	
Degree of protection	IP68 / IP69K
Electrical data	
Rated voltage (III/3)	690 V
Rated surge voltage	6 kV
Rated current	40 A
Surge voltage category/pollution degree	III / 3
Material data	
Housing material	PA
Contact material	Cu
Inflammability class according to UL 94	V0
Mechanical data	
Impact category	IK07
Color	Black
Connector data QUICKON connection	
Core insulation	PVC/PE/TPE/rubber
Structure of individual litz wire/smallest wire diameter	VDE 0295 class 1 to 6/min. 0.15 mm
Connection frequency	max. 10
Conductor cross section [mm ²] solid/stranded	2.5 mm ² ... 6 mm ² / 2.5 mm ² ... 6 mm ²
Conductor cross section [AWG]	14 ... 10
Temperature data	
Ambient temperature (operation)	-40 °C ... 80 °C
Temperature when conductor connected	-5 °C ... 50 °C

Technical data	
4+PE-pos.	
General data	
Degree of protection	IP68 / IP69K
Electrical data	
Rated voltage (III/3)	690 V
Rated surge voltage	6 kV
Rated current	40 A
Surge voltage category/pollution degree	III / 3
Material data	
Housing material	PA
Contact material	Cu
Inflammability class according to UL 94	V0
Mechanical data	
Impact category	IK07
Color	Black
Connector data QUICKON connection	
Core insulation	PVC/PE/TPE/rubber
Structure of individual litz wire/smallest wire diameter	VDE 0295 class 1 to 6/min. 0.15 mm
Connection frequency	max. 10
Conductor cross section [mm ²] solid/stranded	2.5 mm ² ... 6 mm ² / 2.5 mm ² ... 6 mm ²
Conductor cross section [AWG]	14 ... 10
Temperature data	
Ambient temperature (operation)	-40 °C ... 80 °C
Temperature when conductor connected	-5 °C ... 50 °C

Ordering data			
Description	Type	Order No.	Pcs. / Pkt.
H-distributor, with four QUICKON nuts and one sealing bolt, for cable diameters: 9 mm ... 14 mm 12 mm ... 20 mm	QPD H 4PE6,0 4X9-14 BK	1411422	1
	QPD H 4PE6,0 4X12-20 BK	1411425	1
H-distributor, without QUICKON nuts			
QUICKON nut, for connections up to 6.0 mm², for cable diameter: 9 mm ... 14 mm 12 mm ... 20 mm			

Ordering data			
Description	Type	Order No.	Pcs. / Pkt.
	QPD H 4PE6,0 BK	1411426	1
	QPD N 4PE6,0 9-14 BK	1410409	1
	QPD N 4PE6,0 12-20 BK	1410406	1

Installation system

6.0 mm² installation system

T-distributor, 6.0 mm²

- Can be used as a T-distributor with continuous master cable
- Touch-proof in accordance with DIN EN 50274
- Also available as gray color versions



With three QUICKON nuts



With two QUICKON nuts

	Technical data			Technical data		
	4+PE-pos.			4+PE-pos.		
General data						
Degree of protection	IP68 / IP69K			IP68 / IP69K		
Electrical data						
Rated voltage (III/3)	690 V			690 V		
Rated surge voltage	6 kV			6 kV		
Rated current	40 A			40 A		
Surge voltage category/pollution degree	III / 3			III / 3		
Material data						
Housing material	PA			PA		
Contact material	Cu			Cu		
Inflammability class according to UL 94	V0			V0		
Mechanical data						
Impact category	IK07			IK07		
Color	Black			Black		
Connector data QUICKON connection						
Core insulation	PVC/PE/TPE/rubber			PVC/PE/TPE/rubber		
Structure of individual litz wire/smallest wire diameter	VDE 0295 class 1 to 6/min. 0.15 mm			VDE 0295 class 1 to 6/min. 0.15 mm		
Connection frequency	max. 10			max. 10		
Conductor cross section [mm ²] solid/stranded	2.5 mm ² ... 6 mm ² / 2.5 mm ² ... 6 mm ²			2.5 mm ² ... 6 mm ² / 2.5 mm ² ... 6 mm ²		
Conductor cross section [AWG]	14 ... 10			14 ... 10		
Temperature data						
Ambient temperature (operation)	-40 °C ... 80 °C			-40 °C ... 80 °C		
Temperature when conductor connected	-5 °C ... 50 °C			-5 °C ... 50 °C		
	Ordering data			Ordering data		
Description	Type	Order No.	Pcs. / Pkt.	Type	Order No.	Pcs. / Pkt.
T-distributor, with three QUICKON nuts, for cable diameter:						
9 mm ... 14 mm	QPD T 4PE6,0 3X9-14 BK	1411414	1			
12 mm ... 20 mm	QPD T 4PE6,0 3X12-20 BK	1411415	1			
T-distributor, with two QUICKON nuts, for cable diameter:						
9 mm ... 14 mm				QPD T 4PE6,0 2X9-14 BK	1411416	1
12 mm ... 20 mm				QPD T 4PE6,0 2X12-20 BK	1411417	1
QUICKON nut, for connections up to 6.0 mm², for cable diameter:						
9 mm ... 14 mm				QPD N 4PE6,0 9-14 BK	1410409	1
12 mm ... 20 mm				QPD N 4PE6,0 12-20 BK	1410406	1

Cable connector, 6.0 mm²

- Easy cable extension or cable repairs
- The QUICKON connections at opposite ends feature different position markings and mechanical coding
- The 6.0 mm² connector can be used here instead of the QUICKON nut
- Also available as gray color versions



With two QUICKON nuts



With one QUICKON nut

Ⓜ

Technical data

4+PE-pos.

General data	
Degree of protection	IP68 / IP69K
Electrical data	
Rated voltage (III/3)	690 V
Rated surge voltage	6 kV
Rated current	40 A
Surge voltage category/pollution degree	III / 3
Material data	
Housing material	PA
Contact material	Cu
Inflammability class according to UL 94	V0
Mechanical data	
Impact category	IK07
Color	Black
Connector data QUICKON connection	
Core insulation	PVC/PE/TPE/rubber
Structure of individual litz wire/smallest wire diameter	VDE 0295 class 1 to 6/min. 0.15 mm
Connection frequency	max. 10
Conductor cross section [mm ²] solid/stranded	2.5 mm ² ... 6 mm ² / 2.5 mm ² ... 6 mm ²
Conductor cross section [AWG]	10 ... 14
Temperature data	
Ambient temperature (operation)	-40 °C ... 80 °C
Temperature when conductor connected	-5 °C ... 50 °C

Ⓜ

Technical data

4+PE-pos.

General data	
Degree of protection	IP68 / IP69K
Electrical data	
Rated voltage (III/3)	690 V
Rated surge voltage	6 kV
Rated current	40 A
Surge voltage category/pollution degree	III / 3
Material data	
Housing material	PA
Contact material	Cu
Inflammability class according to UL 94	V0
Mechanical data	
Impact category	IK07
Color	Black
Connector data QUICKON connection	
Core insulation	PVC/PE/TPE/rubber
Structure of individual litz wire/smallest wire diameter	VDE 0295 class 1 to 6/min. 0.15 mm
Connection frequency	max. 10
Conductor cross section [mm ²] solid/stranded	2.5 mm ² ... 6 mm ² / 2.5 mm ² ... 6 mm ²
Conductor cross section [AWG]	10 ... 14
Temperature data	
Ambient temperature (operation)	-40 °C ... 80 °C
Temperature when conductor connected	-5 °C ... 50 °C

Ordering data

Description	Type	Order No.	Pcs. / Pkt.
Cable connector, with two QUICKON nuts, for cable diameters: 9 mm ... 14 mm 12 mm ... 20 mm	QPD C 4PE6,0 2X9-14 BK	1410410	1
	QPD C 4PE6,0 2X12-20 BK	1410412	1
Cable connector, with one QUICKON nut, for cable diameters: 9 mm ... 14 mm 12 mm ... 20 mm			
QUICKON nut, for connections up to 6.0 mm², for cable diameter: 9 mm ... 14 mm 12 mm ... 20 mm			

Ordering data

Type	Order No.	Pcs. / Pkt.
QPD C 4PE6,0 1X9-14 BK	1410415	1
QPD C 4PE6,0 1X12-20 BK	1410416	1
QPD N 4PE6,0 9-14 BK	1410409	1
QPD N 4PE6,0 12-20 BK	1410406	1

Installation system

6.0 mm² installation system

Panel feed-throughs, 6.0 mm²

- Devices no longer need to be opened in order to connect the cables
- User-friendly connection, even on devices that are difficult to access
- Touch-proof in accordance with DIN EN 50274
- Also available as gray color versions



With one QUICKON nut



Without QUICKON nut

Ⓡ

Technical data

4+PE-pos.

General data	
Degree of protection	IP68 / IP69K
Electrical data	
Rated voltage (III/3)	690 V
Rated surge voltage	6 kV
Rated current	40 A
Surge voltage category/pollution degree	III / 3
Material data	
Housing material	PA
Contact material	Cu
Inflammability class according to UL 94	V0
Mechanical data	
Impact category	IK07
Color	Black
Connector data QUICKON connection	
Core insulation	PVC/PE/TPE/rubber
Structure of individual litz wire/smallest wire diameter	VDE 0295 class 1 to 6/min. 0.15 mm
Connection frequency	max. 10
Conductor cross section [mm ²] solid/stranded	2.5 mm ² ... 6 mm ² / 2.5 mm ² ... 6 mm ²
Conductor cross section [AWG]	14 ... 10
Temperature data	
Ambient temperature (operation)	-40 °C ... 80 °C
Temperature when conductor connected	-5 °C ... 50 °C

Ⓡ

Technical data

4+PE-pos.

General data	
Degree of protection	IP68 / IP69K
Electrical data	
Rated voltage (III/3)	690 V
Rated surge voltage	6 kV
Rated current	40 A
Surge voltage category/pollution degree	III / 3
Material data	
Housing material	PA
Contact material	Cu
Inflammability class according to UL 94	V0
Mechanical data	
Impact category	IK07
Color	Black
Connector data QUICKON connection	
Core insulation	PVC/PE/TPE/rubber
Structure of individual litz wire/smallest wire diameter	VDE 0295 class 1 to 6/min. 0.15 mm
Connection frequency	max. 10
Conductor cross section [mm ²] solid/stranded	2.5 mm ² ... 6 mm ² / 2.5 mm ² ... 6 mm ²
Conductor cross section [AWG]	14 ... 10
Temperature data	
Ambient temperature (operation)	-40 °C ... 80 °C
Temperature when conductor connected	-5 °C ... 50 °C

Ordering data

Description	Cable length
Panel feed-through , with M25 x 1.5 mounting flange, with one QUICKON nut, for cable diameter:	
9 mm ... 14 mm	0.5 m
9 mm ... 14 mm	1 m
12 mm ... 20 mm	0.5 m
12 mm ... 20 mm	1 m
Panel feed-through , with M25 x 1.5 mounting flange, without QUICKON nut	
	0.5 m
	1 m
QUICKON nut , for connections up to 6.0 mm ² , for cable diameter:	
9 mm ... 14 mm	
12 mm ... 20 mm	

Type	Order No.	Pcs. / Pkt.
QPD W 4PE6,0 9-14 M25 0,5 BK	1410392	1
QPD W 4PE6,0 9-14 M25 1,0 BK	1410393	1
QPD W 4PE6,0 12-20 M25 0,5 BK	1410394	1
QPD W 4PE6,0 12-20 M25 1,0 BK	1410395	1

Ordering data

Type	Order No.	Pcs. / Pkt.
QPD W 4PE6,0 M25 0,5 BK	1410396	1
QPD W 4PE6,0 M25 1,0 BK	1410397	1
QPD N 4PE6,0 9-14 BK	1410409	1
QPD N 4PE6,0 12-20 BK	1410406	1

Connector, 6.0 mm²

new

- With capacitive PE contact
- Compatible with QUICKON connection
- Can be coded using the two red coding profiles to prevent incorrect connection of similar connectors
- Touch-proof in accordance with DIN EN 50274
- Also available as gray color versions
- With SPEEDCON fast locking system



With gray screw locking

Technical data

4+PE-pos.

General data	
Degree of protection	IP68 / IP69K
Electrical data	
Rated voltage (III/3)	690 V
Rated surge voltage	6 kV
Rated current	40 A
Surge voltage category/pollution degree	III / 3
Material data	
Housing material	PA
Contact material	Cu
Contact surface material	Silver-plated
Inflammability class according to UL 94	V0
Impact category	IK07
Color	Black
Connector data QUICKON connection	
Core insulation	PVC/PE/TPE/rubber
Structure of individual litz wire/smallest wire diameter	VDE 0295 class 1 to 6/min. 0.15 mm
Connection frequency	10
Conductor cross section [mm ²] solid/stranded	2.5 mm ² ... 6 mm ² / 2.5 mm ² ... 6 mm ²
Conductor cross section [AWG]	14 ... 10
Temperature data	
Ambient temperature (operation)	-40 °C ... 80 °C
Temperature when conductor connected	-5 °C ... 50 °C

Ordering data

Description	Type	Order No.	Pcs. / Pkt.
Connectors, for cable diameters: 9 mm ... 14 mm 12 mm ... 20 mm	QPD P 4PE6,0 9-14 BK	1410386	1
	QPD P 4PE6,0 12-20 BK	1410387	1

Installation system

6.0 mm² installation system

Accessories

- Plastic labels ③ can be stuck to the middle of the H-distributor
- Red sealing plugs ④ can be easily stuck into the QUICKON nuts and create a seal when screwed tight
- Protective caps with retaining cords ⑤ for closing open QUICKON domes which are going to have a connector (for example) fitted at a later date
- Locking nuts ⑥ for fixing the panel feed-throughs to thin panels that are unable to accommodate a proprietary thread
- Insulating sleeve ⑦ for 4.8 mm slip-on connections
- Transparent protective caps ⑧ for attaching to the open QUICKON dome
- Transparent protective caps ⑨ at front for attaching to the connector
- Aluminum shielding tape ⑬ prevents the splicing of the braided shield and enables a clean shield connection



Description	Ordering data		
	Type	Order No.	Pcs. / Pkt.
Plastic label ③ For plotting and engraving Can be printed using thermal transfer printer	GPE 13X 9 WH EMLP (13X9)R	0806932 0819453	10 1
Closing cap , for closing unused bore holes in multiple seals and cable glands ④ Ø 10 mm Ø 14 mm	SEALING PLUG 10X16 RD SEALING PLUG 14X22 RD	1400284 1400270	10 10
Protective cap , captive, IP68 ⑤	QPD QSK GY 5X6,0 FS QPD QSK BK 5X6,0 FS	1411401 1411400	1 1
Counter nut , (plastic), to lock the contact carrier from the inside of the device ⑥ M25/SW32/color: black	Q-MU M25	1640715	25
Insulating sleeve , ⑦ as shock protection for 4.8 mm slip-on sleeves; first slide over the conductor For 4.8 mm slip-on sleeves	PT/FS 4,8	1670497	25
Protective cap , transparent plastic, for QUICKON connection, IP54 ⑧	QPD QSK 5X6,0	1411403	10
Protective cap , transparent plastic, for QUICKON connection, IP50 ⑨	QPD PSK 5X6,0	1411404	10
Coding profile , for insertion into the connector and QUICKON dome ⑪	CP-QPD 5X6,0	1411402	10
Shielding tape , for shielded QPD versions ⑬	ALU-SB	1404531	100

Panel feed-throughs, 2.5 mm² for intrinsically safe circuits

- Devices no longer need to be opened in order to connect the cables
- User-friendly connection, even on devices that are difficult to access
- Touch-proof in accordance with DIN EN 50274

Notes:
Intended for applications in intrinsically safe circuits according to EN 60079-11 and EN 60079-14.



With litz wires



With manual solder/slip-on connection



Technical data	
4+PE-pos.	
General data	
Degree of protection	IP68 / IP69K
Electrical data	
Rated voltage	60 V
Rated surge voltage	6 kV
Surge voltage category/pollution degree	III / 3
Material data	
Housing material	PA
Contact material	Cu
Inflammability class according to UL 94	V0
Mechanical data	
Impact category	IK07
Color	Black
Connector data QUICKON connection	
Core insulation	PVC/PE/TPE/rubber
Structure of individual litz wire/smallest wire diameter	VDE 0295 class 1 to 6/min. 0.15 mm
Connection frequency	max. 10
Conductor cross section [mm ²] solid/stranded	1 mm ² ... 2.5 mm ² / 1 mm ² ... 2.5 mm ²
Conductor cross section [AWG]	16 ... 14
Temperature data	
Ambient temperature (operation)	-40 °C ... 80 °C
Temperature when conductor connected	-5 °C ... 50 °C

Technical data	
4+PE-pos.	
General data	
Degree of protection	IP68 / IP69K
Electrical data	
Rated voltage	60 V
Rated surge voltage	6 kV
Surge voltage category/pollution degree	III / 3
Material data	
Housing material	PA
Contact material	Cu
Inflammability class according to UL 94	V0
Mechanical data	
Impact category	IK07
Color	Black
Connector data QUICKON connection	
Core insulation	PVC/PE/TPE/rubber
Structure of individual litz wire/smallest wire diameter	VDE 0295 class 1 to 6/min. 0.15 mm
Connection frequency	max. 10
Conductor cross section [mm ²] solid/stranded	1 mm ² ... 2.5 mm ² / 1 mm ² ... 2.5 mm ²
Conductor cross section [AWG]	16 ... 14
Temperature data	
Ambient temperature (operation)	-40 °C ... 80 °C
Temperature when conductor connected	-5 °C ... 50 °C

Technical data	
4+PE-pos.	
General data	
Degree of protection	IP68 / IP69K
Electrical data	
Rated voltage	60 V
Rated surge voltage	6 kV
Surge voltage category/pollution degree	III / 3
Material data	
Housing material	PA
Contact material	Cu
Inflammability class according to UL 94	V0
Mechanical data	
Impact category	IK07
Color	Black
Connector data QUICKON connection	
Core insulation	PVC/PE/TPE/rubber
Structure of individual litz wire/smallest wire diameter	VDE 0295 class 1 to 6/min. 0.15 mm
Connection frequency	max. 10
Conductor cross section [mm ²] solid/stranded	1 mm ² ... 2.5 mm ² / 1 mm ² ... 2.5 mm ²
Conductor cross section [AWG]	16 ... 14
Temperature data	
Ambient temperature (operation)	-40 °C ... 80 °C
Temperature when conductor connected	-5 °C ... 50 °C

Ordering data	
Description	Cable length
Panel feed-through, with M20 x 1.5 mounting flange, with QUICKON nut, for cable diameter:	
6 mm ... 11 mm	0.5 m
6 mm ... 11 mm	1 m
6 mm ... 11 mm	
9 mm ... 16 mm	0.5 m
9 mm ... 16 mm	1 m
9 mm ... 16 mm	
Panel feed-through, with M25 x 1.5 mounting flange, with QUICKON nut, for cable diameters:	
6 mm ... 11 mm	0.5 m
6 mm ... 11 mm	1 m
6 mm ... 11 mm	
9 mm ... 16 mm	0.5 m
9 mm ... 16 mm	1 m
9 mm ... 16 mm	

Ordering data			
Type	Order No.	Pcs. / Pkt.	
QPD W 4PE2,5 6-11 M20 0,5 EX	1411393	1	
QPD W 4PE2,5 6-11 M20 1,0 EX	1411394	1	
QPD W 4PE2,5 9-16 M20 0,5 EX	1411397	1	
QPD W 4PE2,5 9-16 M20 1,0 EX	1411398	1	
QPD W 4PE2,5 6-11 M25 0,5 EX	1411387	1	
QPD W 4PE2,5 6-11 M25 1,0 EX	1411388	1	
QPD W 4PE2,5 9-16 M25 0,5 EX	1411390	1	
QPD W 4PE2,5 9-16 M25 1,0 EX	1411391	1	

Ordering data			
Type	Order No.	Pcs. / Pkt.	
QPD W 4PE2,5 6-11 M20 FC EX	1411395	1	
QPD W 4PE2,5 9-16 M20 FC EX	1411399	1	
QPD W 4PE2,5 6-11 M25 FC EX	1411389	1	
QPD W 4PE2,5 9-16 M25 FC EX	1411392	1	



- Particularly suitable for connecting drives of up to 15 kW using wires with ring cable lugs
- Direct connection without the need to open the motor terminal box

Pin assignment

- Pos. 1 BK (black)
- Pos. 2 BN (brown)
- Pos. 3 GY (gray)
- Pos. \perp GNYE (green-yellow)

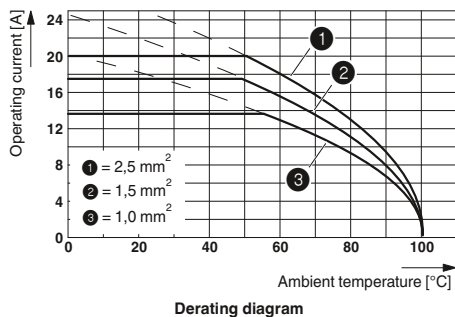

Panel feed-throughs with/without QUICKON nut



Technical data

General data	
Pollution degree	3
Degree of protection	IP68 / IP69K
Electrical data	
Rated voltage (III/3)	690 V
Rated surge voltage	6 kV
Rated current	20 A
Surge voltage category	III
Material data	
Housing material	PA
Contact material	Cu
Contact surface material	Silver-plated
Contact carrier material	PA
Inflammability class according to UL 94	V0
Mechanical data	
Wrench size, union nut	22 mm
Tightening torque, union nut	5 Nm
Tightening torque, contact carrier	-
Impact category	IK07
Connector data QUICKON connection	
Core insulation	PVC/PE/TPE/rubber
Structure of individual litz wire/smallest wire diameter	VDE 0295 class 1 to 6/min. 0.15 mm
Connection frequency	10
Conductor cross section [mm²] solid/stranded	1 mm² ... 2.5 mm² / 1 mm² ... 2.5 mm²
Conductor cross section [AWG]	16 ... 14
Temperature data	
Ambient temperature (operation)	-40 °C ... 80 °C
Temperature when conductor connected	-5 °C ... 50 °C

Ordering data

Description	Type	Order No.	Pcs. / Pkt.
Panel feed-through, 3+PE-pos., with QUICKON nut, with four welded-on 1.5 mm² cable wires, with ring cable lugs at the end, for cable diameters:			
6 mm ... 10 mm	QPDW3PE1,5 6-10 M25 0,1 BKKTH	1582475	1
9 mm ... 14 mm	QPDW3PE1,5 9-14 M25 0,1 BKKTH	1582476	1
Panel feed-through, 3+PE-pos., without QUICKON nut, with four welded-on 1.5 mm² cable wires, with ring cable lugs at the end			
	QPD W 3PE1,5 M25 0,1 BK K TH	1577273	1

Assembled cables, 2.5 mm²

- Connecting cable between two QUICKON connections
- User-friendly connection, even on devices that are difficult to access
- Touch-proof in accordance with DIN EN 50274
- Other versions available on request
- With SPEEDCON fast locking system



4+PE-pos.



Technical data	
General data	
Degree of protection	IP68 / IP69K
Electrical data	
Rated voltage (III/3)	690 V
Rated surge voltage	6 kV
Rated current	20 A
Surge voltage category/pollution degree	III / 3
Material data	
Housing material	PA
Contact material	Cu
Inflammability class according to UL 94	V0
Mechanical data	
Impact category	IK07
Color	Black
Connector data QUICKON connection	
Core insulation	PVC/PE/TPE/rubber
Structure of individual litz wire/smallest wire diameter	VDE 0295 class 1 to 6/min. 0.15 mm
Connection frequency	max. 10
Conductor cross section [mm ²] solid/stranded	1 mm ² ... 2.5 mm ² / 1 mm ² ... 2.5 mm ²
Conductor cross section [AWG]	16 ... 14
Temperature data	
Ambient temperature (operation)	-40 °C ... 80 °C
Temperature when conductor connected	-5 °C ... 50 °C

Ordering data				
Description	Cable length	Type	Order No.	Pcs. / Pkt.
Assembled cable				
	1 m	QPD 5P/ 1,0-PVC/5P 5X2,5 BK	1408720	1
	3 m	QPD 5P/ 3,0-PVC/5P 5X2,5 BK	1408721	1
	5 m	QPD 5P/ 5,0-PVC/5P 5X2,5 BK	1408722	1
	10 m	QPD 5P/10,0-PVC/5P 5X2,5 BK	1408723	1



Heavy-duty connectors

HEAVYCON are industrial connectors for harsh operating conditions. The product range consists of housings, contact inserts, cable glands, and accessories. The housings are available in versions for different ambient conditions. For contact inserts, a distinction is made between fixed, modular, and combined versions.

Housing

The ambient conditions determine the material from which the housings are produced. With HEAVYCON EVO, for example, high-grade industrial plastics and NBR seals cover a wide range of industrial environments.

In applications where plastic cable glands have already proven themselves, there is nothing standing in the way of using plastic HEAVYCON EVO. Metal housings are essential for EMC applications, but also for applications with high cable tensile load or extreme temperatures.

For plug-in connections that are only for startup or infrequent servicing, HEAVYCON ADVANCE or HPR housings with screw locking are recommended for economic reasons. These series are characterized in particular by their stability, and excellent EMC shielding.

Contact inserts with a fixed number of positions

Fixed contact inserts are contact carriers and contacts with different connection technologies such as screw, spring, crimp, insulation displacement, and axial screw connections.

Modular contact inserts

Modular contact inserts allow you to combine several individual connectors, e.g., for power, data, signals, and pneumatics, in the same connector housing.

HEAVYCON product range overview

HEAVYCON cross-reference list - contact inserts and housing	482
Series D7	
Contact inserts	484
Housing	490
Series D	
Contact inserts	494
Housing	502
Series B	
Contact inserts	512
Housing	570
Connector sets	622
Housing for railway applications	626
Compact series	
Contact inserts	630
Housing	632
Accessories	
Contact inserts	634
Housing	642
DUPLICON stackable power distribution	654



STANDARD connectors

The robust metal housings of the connectors are resistant to dirt, water, vibration and high mechanical loads. Standard housings have a single or double locking latch. Various supporting base elements such as panel mounting bases, box mounting bases or coupling housings are available as required. In addition to contact inserts with a fixed number of positions, modular contact inserts are also available.



EVO connectors

The EVO connectors are characterized by the patented EVO-Lock system. It allows the cable outlet direction to be freely selected during assembly. This reduces the stored housing variance by up to 75%. The EVO housings are compatible with standard aluminum housings. They fit the standard panel cutouts of heavy-duty connectors.



ADVANCE connectors

Space and cost savings as there is no need for panel mounting bases. The ADVANCE housings with screw locking are suitable for the most stringent requirements, such as particularly aggressive atmospheres and sensitive interfaces. In addition to contact inserts with a fixed number of positions, modular contact inserts are also available.



Contact inserts with a fixed number of positions

The range includes A/B/BB/BBB/D/DD/HS/HV and K series contact inserts. The B series is available with screw, crimp, push-in, and QUICKON connection.



Modular contact inserts

There is an increasing demand for data, control signals, and energy supply to be combined in a single connector housing. With 4 frame sizes and 25 contact inserts to choose from, individual combinations can be created.



Housing for railway applications

HEAVYCON HPR is specified for use in transport and transportation technology. The sleeve housings, panel mounting bases, and box mounting bases conform to the established standard for the safe transmission of signal and power circuits on rail vehicles. They offer protection class IP68/IP69K and ensure comprehensive protection in the event of electromagnetic interference fields.



Stackable power distribution

DUPLICON stackable connectors are designed for distributed installation with the focus on power distribution. The connectors can be easily and flexibly integrated into modular machines and systems. Thanks to this stackable design, DUPLICON offers consistent installation, from the busbar in the control cabinet to the PCB in the field device, and can be extended by simply connecting further connectors.

Find out more with the web code

Detailed information on these products can be found on our website. Simply enter # and numbers in the search field.

#0002

Search



Heavy-duty connectors

HEAVYCON cross-reference list - contact inserts and housing

The top rows describe the contact insert according to the number of positions, voltage, current, and connection method.

The markings in the columns denote the corresponding housing size.



Configurator for creating complete connectors can be found on our website:

i Your web code: #0003

	A					B						BB						BBB	
Series																			
Number of positions	3	4	10	16	2x16	6	10	16	24	2x16	2x24	10	18	32	46	2x32	2x46	40	64
Housing size	D7	D7	D15	D25	D50	B6	B10	B16	B24	B32	B48	B6	B10	B16	B24	B32	B48	B16	B24
Rated voltage [V]	230/400		250			500						500						500	
Rated current [A]	24		20			16						16						16	
Connection method	UT					UT						-						-	
CT = Crimp	-					CT						CT						CT	
PT = Push-in	-					PT						-						-	
Z = Spring	-					-						-						-	
Q = QUICKON	Q	-				Q						-						-	
L = Fiber optics	-					-						-						-	
A = Axial screw	-					-						-						-	
P = Pneumatics	-					-						-						-	

	A					B						BB						BBB	
Series																			
Number of positions	3	4	10	16	2x16	6	10	16	24	2x16	2x24	10	18	32	46	2x32	2x46	40	64
Page	484	484	494	496	496	520	522	524	526	524	526	532	532	532	532	532	532	534	534
From 490	●	●																	
From 502			●																
From 506				●															
From 510					●														
From 570						●						●							
From 576							●						●						
From 590								●						●				●	
From 604									●						●				●
From 618										●						●			
From 620											●						●		
From 626						●						●							
From 627							●						●						
From 628								●						●				●	
From 629									●						●				●

HEAVYCON housing

D7, D15 to D50, and EVO D housing		D7
		D15
		D25
		D50

STANDARD, EVO, and ADVANCE housing		B6
		B10
		B16
		B24
		B32
		B48

HPR housing		B6
		B10
		B16
		B24

HEAVYCON contact inserts

D										DD						HV			HS		Q				K		M		
7	8	15	25	40	2x25	64	2x40	2x64	24	42	72	108	2x72	2x108	3+2	6+2	10+2	6	12	2	5	7	12	Variable	Variable				
D7	D7	D15	D25	B16	D50	B24	B32	B48	B6	B10	B16	B24	B32	B48	B10	B16	B24	B16	B32	D7	D7	D7	D7	B10 - B24	B6 - B48				
250		50		250						250						830			400/690		400		230/400		400		160 - 830		50 - 5000
10										10						16			35		40		16		10		10 - 80		5 - 200
-										-						-			UT		-				UT		-		
CT										CT						CT			-		-				CT		CT		
-										-						PT			-		-				-		-		
-										-						-			-		-				-		Z		
-										-						-			-		-				-		-		
L										L						-			-		-				L		L		
-										-						-			-		A				A		A		
-										-						-			-		-				-		P		
D										DD						HV			HS		Q				K		M		
7	8	15	25	40	2x25	64	2x40	2x64	24	42	72	108	2x72	2x108	3	6	10	6	12	2	5	7	12	Variable	Variable				
486	486	498	500	512	500	512	512	512	518	518	518	518	518	518	536	538	540	542	542	488	488	488	488	544	548				
●	●																			●	●	●	●						
		●																											
			●																										
				●						●															●				
											●														●				
												●													●				
													●												●				
														●											●				
															●										●				
																●									●				
																	●								●				
																		●							●				
																			●						●				
																				●					●				

Heavy-duty connectors

HEAVYCON D7 - contact inserts

A3, A4 series

230/400 V, 10 - 24 A

Connection technology:

- Screw connection
- Insulation displacement connection

To determine the corresponding housing, see cross-reference list on page 482.

Notes:
For accessories, see from page 634
HC-A03-I-UT... / HC-A04-I-UT... profile gaskets made from NBR
HC-A04-I-UT... contact inserts already contain an IP65 sealing screw
Only operate connectors when there is no load/the power is switched off
For assembly instructions, see phoenixcontact.net/products
For connection technologies, see page 4
1) For solid conductors and stranded wires with wire end protection



Type	Technical data			
	① HC-A03-I-UT...	② HC-A3...Q1,5-TFL-G-PA Sleeve housing	③ HC-A3...Q1,5-KML-G-PA Coupling housing	④ HC-A04-I-UT...
Approvals	-			-
IEC data				
Rated current, contacts (at 40°C)	A	10	10	24
Surge voltage category	III	III	III	III
Pollution degree	3	3	3	3
Rated voltage (III/3) contacts	V	230 / 400	230 / 400	230 / 400
Rated surge voltage, contacts	kV	4	4	4
Connection cross section	mm ²	0.5 ... 2.5	0.75 ... 1.5	0.5 ... 2.5
UL data				
Rated voltage	V	-	600	-
Rated current	A	-	10	-
Connection cross section	AWG	-	18-16	-
CSA / cUL data				
Rated voltage	V	-	600	-
Rated current	A	-	10	-
Connection cross section	AWG	-	18-16	-
Material data				
Contact carrier material	PC	PA / PC	PA / PC	PC
Inflammability class in acc. with UL 94	V0	V0	V0	V0
Contact material	Copper alloy	Copper alloy	Copper alloy	Copper alloy
Contact surface material	Ag	Ag	Ag	Ag
Temperature data				
Ambient temperature range	°C	-40 ... 125	-25 ... 80	-40 ... 125
General data				
Connection method	Screw connection	QUICKON connection	QUICKON connection	Screw connection
Stripping length	mm	5	-	5
No. of pos.	3	3	3	4
Contact numbering	1 - 3	1 - 3	1 - 3	1 - 4
Insertion/withdrawal cycles	≥ 500	≥ 500	≥ 500	≥ 500



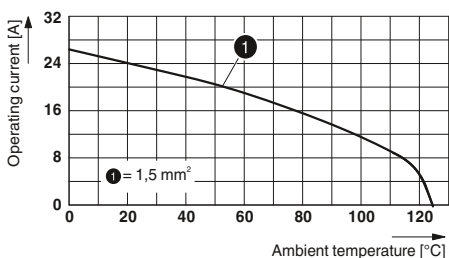

Derating curves

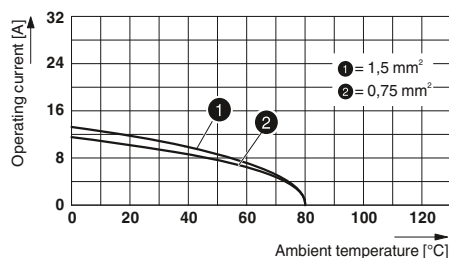

HC-A03... / HC-A04...

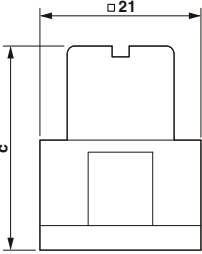

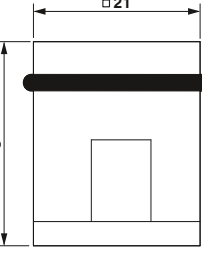
HC-A 3...Q1,5...

Description	Pos.	Number	Size	Type	Ordering data		Pcs. / Pkt.	Dimensions (in mm)																																													
					Socket	Plug																																															
Screw connection¹⁾ 	3	1 - 3	D7	① HC-A03-I-UT-...	1585223	1585210	1	 Dimensional drawing: socket																																													
Insulation displacement connection 	3	1 - 3	D7	Sleeve housing ② HC-A3-...Q1,5-TFL-G-PA	1641510	1641581	1																																														
Insulation displacement connection 	3	1 - 3	D7	Coupling housing ③ HC-A3-...Q1,5-KML-G-PA	1641617	1641604	1	 Dimensional drawing: plug																																													
Screw connection¹⁾ 	4	1 - 4	D7	④ HC-A04-I-UT-...	1585249	1585236	1	<table border="1"> <thead> <tr> <th></th> <th>a</th> <th>b</th> <th>c</th> <th>d</th> </tr> </thead> <tbody> <tr> <td>① Socket</td> <td></td> <td></td> <td>30</td> <td></td> </tr> <tr> <td>① Plug</td> <td></td> <td></td> <td></td> <td></td> </tr> <tr> <td>② Socket</td> <td></td> <td></td> <td>66</td> <td></td> </tr> <tr> <td>② Plug</td> <td></td> <td></td> <td></td> <td></td> </tr> <tr> <td>③ Socket</td> <td></td> <td></td> <td>62.8</td> <td></td> </tr> <tr> <td>③ Plug</td> <td></td> <td></td> <td></td> <td></td> </tr> <tr> <td>④ Socket</td> <td></td> <td></td> <td>30</td> <td></td> </tr> <tr> <td>④ Plug</td> <td></td> <td></td> <td></td> <td></td> </tr> </tbody> </table>		a	b	c	d	① Socket			30		① Plug					② Socket			66		② Plug					③ Socket			62.8		③ Plug					④ Socket			30		④ Plug				
	a	b	c	d																																																	
① Socket			30																																																		
① Plug																																																					
② Socket			66																																																		
② Plug																																																					
③ Socket			62.8																																																		
③ Plug																																																					
④ Socket			30																																																		
④ Plug																																																					

Accessories



Sealing screw, IP65
From page 653



Coding profile
From page 568



Replacement latch
From page 652

Heavy-duty connectors

HEAVYCON D7 - contact inserts

D7, D8 series

50 - 250 V, 10 A

Connection technology:

– Crimp connection

To determine the corresponding housing, see cross-reference list on page 482.

Notes:
For accessories, see from page 634
Coding of HC-D 7-I-CT... / HC-D 8-I-CT... contact inserts using CK 1,6 ED-BB dummy sockets
HC-D 7... / HC-D 8... contact inserts already contain an IP65 sealing screw
Order crimp contacts separately
Only operate connectors when there is no load/the power is switched off
For assembly instructions, see phoenixcontact.net/products
For connection technologies, see page 4
1) For voltages > 42 V, only use with plastic housing



Type	Technical data	
	① HC-D 7-I-CT-...	② HC-D 8-I-CT-... Without PE
Approvals	ERC	ERC
IEC data		
Rated current, contacts (at 40°C)	A 10	10
Surge voltage category	III	III
Pollution degree	3	3
Rated voltage (III/3) contacts	V 250 ¹⁾	50
Rated surge voltage, contacts	kV 4	0.8
Connection cross section	mm ² 0.14 ... 2.5	0.14 ... 2.5
UL data		
Rated voltage	V 600	600
Rated current	A 12	12
Connection cross section	AWG 14	14
CSA / cUL data		
Rated voltage	V -	-
Rated current	A -	-
Connection cross section	AWG -	-
Material data		
Contact carrier material	PC	PC
Inflammability class in acc. with UL 94	V0	V0
Contact material	Copper alloy	Copper alloy
Contact surface material	Ag (alternatively Au)	Ag (alternatively Au)
Temperature data		
Ambient temperature range	°C -40 ... 125	-40 ... 125
General data		
Connection method	Crimp connection	Crimp connection
Stripping length	mm 8	8
No. of pos.	7	8
Contact numbering	1 - 7	1 - 8
Insertion/withdrawal cycles	≥ 500	≥ 500



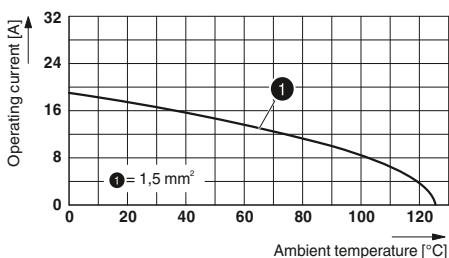

Derating curves

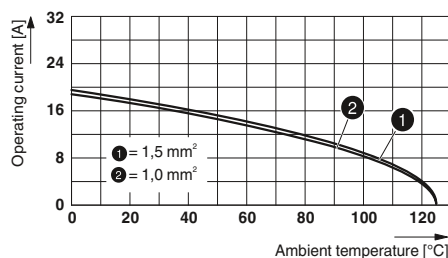

HC-D 7-I-CT-...

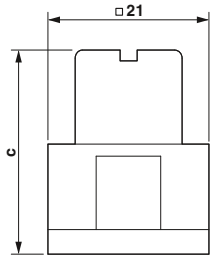

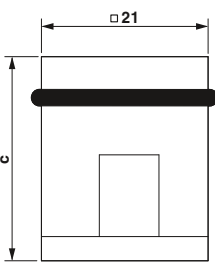
HC-D 8-I-CT-....

Description	Pos.	Number	Size	Ordering data			Pcs. / Pkt.	Dimensions (in mm)																									
				Type	Socket	Plug																											
Crimp connection 	7	1 - 7	D7	① HC-D 7-I-CT-...	1584347	1584334	10	 Dimensional drawing: socket																									
Crimp connection 	8	1 - 8	D7	Without PE ② HC-D 8-I-CT-...	1584363	1584350	10		 Dimensional drawing: plug																								
Turned crimp contacts CK 1,6 Silver-plated 								<table border="1"> <thead> <tr> <th></th> <th>a</th> <th>b</th> <th>c</th> <th>d</th> </tr> </thead> <tbody> <tr> <td>① Socket</td> <td></td> <td></td> <td>32</td> <td></td> </tr> <tr> <td>① Plug</td> <td></td> <td></td> <td>32</td> <td></td> </tr> <tr> <td>② Socket</td> <td></td> <td></td> <td>32</td> <td></td> </tr> <tr> <td>② Plug</td> <td></td> <td></td> <td></td> <td></td> </tr> </tbody> </table>		a	b	c	d	① Socket			32		① Plug			32		② Socket			32		② Plug				
	a	b	c	d																													
① Socket			32																														
① Plug			32																														
② Socket			32																														
② Plug																																	
	Cross section mm ² / AWG																																
	0.14 - 0.37 / 26 - 22		CK1,6-ED-0,37... AG	1663394	1663336	100																											
	0.5 / 20		CK1,6-ED-0,50... AG	1663404	1663349	100																											
	0.75 / 18		CK1,6-ED-0,75... AG	1663417	1663352	100																											
	0.75 - 1 / 18		CK1,6-ED-1,00... AG	1663420	1663365	100																											
	1.5 / 16		CK1,6-ED-1,50... AG	1663433	1663378	100																											
	2.5 / 14		CK1,6-ED-2,50... AG	1663446	1663381	100																											
Turned crimp contacts CK 1,6 Gold-plated 																																	
	Cross section mm ² / AWG																																
	0.14 - 0.37 / 22 - 24		CK1,6-ED-0,37... AU	1674969	1674901	100																											
	0.75 / 18		CK1,6-ED-0,75... AU	1672440	1672453	100																											
	0.75 / 18		CK1,6-ED-0,75... AU	1672440	1674914	100																											
	0.75 - 1 / 18		CK1,6-ED-1,00... AU	1674943	1674888	100																											
	1.5 / 16		CK1,6-ED-1,50... AU	1674930	1674875	100																											

Accessories



Crimping tools
From page 636



Sealing screw, IP65
From page 653



Dummy sockets
phoenixcontact.net/products

Heavy-duty connectors

HEAVYCON D7 - contact inserts

Q series

250 - 500 V, 10 - 40 A

Connection technology:

- Axial screw connection
- Crimp connection

To determine the corresponding housing, see cross-reference list on page 482.

Notes:
For accessories, see from page 634
Order crimp contacts separately
Only operate connectors when there is no load/the power is switched off
For assembly instructions, see phoenixcontact.net/products
For connection technologies, see page 4



Type	Technical data			
	① HC-HS 2-D7-E...S	② HC-Q05-I-CT-...	③ HC-D 7-E...C-COD	④ HC-Q 12-I-CT-...
Approvals	UL US ENEC	ENEC UL	UL US ENEC	ENEC
IEC data				
Rated current, contacts (at 40°C)	A	40	24	10
Surge voltage category		III	III	III
Pollution degree		3	3	3
Rated voltage (III/3) contacts	V	400	230 / 400	400
Rated surge voltage, contacts	kV	6	4	6
Connection cross section	mm ²	4 ... 10	0.5 ... 2.5	0.14 ... 2.5
UL data				
Rated voltage	V	400	600	600
Rated current	A	28	24	10
Connection cross section	AWG	12	14	14
CSA / cUL data				
Rated voltage	V	400	-	600
Rated current	A	26	-	10
Connection cross section	AWG	12	-	14
Material data				
Contact carrier material		PC	PA	PC
Inflammability class in acc. with UL 94		V0	V0	V0
Contact material		Copper alloy	Copper alloy	Copper alloy
Contact surface material		Ag	Ag (alternatively Au)	Ag (alternatively Au)
Temperature data				
Ambient temperature range	°C	-40 ... 125	-40 ... 125	-40 ... 125
General data				
Connection method		Axial screw connection	Crimp connection	Crimp connection
Hexagonal socket	mm	2	-	-
Stripping length	mm	8	7.5	8
No. of pos.		2	5	7
Contact numbering		1 - 2	1 - 5	1 - 7
Insertion/withdrawal cycles		≥ 500	≥ 500	≥ 500

Derating curves

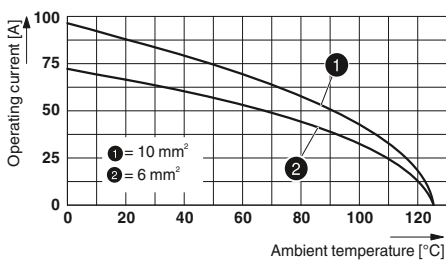



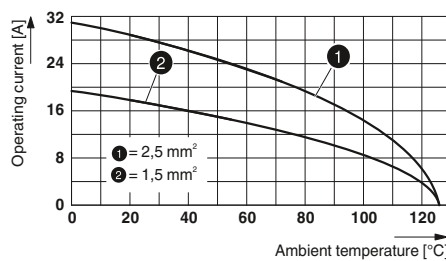

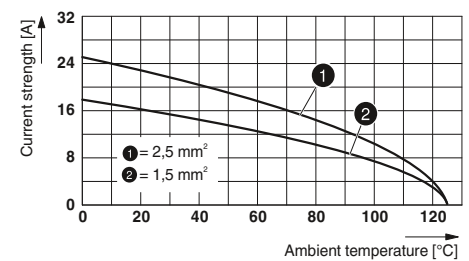

HC-HS 2-D7-E...S

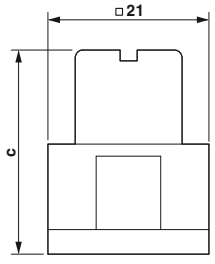
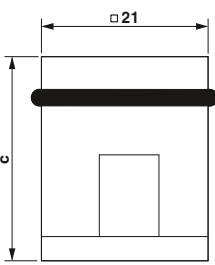

HC-Q05-I-CT-...



HC-D 7-E...C-COD

				Ordering data			Dimensions (in mm)																																																		
Description	Pos.	Number	Size	Type	Order No.		Pcs. / Pkt.																																																		
					Socket	Plug																																																			
Axial screw connection																																																									
	2	1 - 2	D7	① HC-HS 2-D7-E...S	1586264	1586277	10	 <p>Dimensional drawing: socket</p>  <p>Dimensional drawing: plug</p>																																																	
Crimp connection CK 2,5																																																									
	5	1 - 5	D7	② HC-Q05-I-CT...	1406537	1406538	1																																																		
Crimp connection CK 1,6																																																									
	7	1 - 7	D7	③ HC-D 7-E...C-COD	1408588	1408575	10																																																		
Crimp connection CK 1,6																																																									
	12	1 - 12	D7	④ HC-Q 12-I-CT...	1409419	1409422	1																																																		
Turned crimp contacts CK 1,6 Silver-plated																																																									
			Cross section mm ² / AWG																																																						
			0.14 - 0.37 / 26 - 22	CK1,6-ED-0,37... AG	1663394	1663336	100	<table border="1"> <thead> <tr> <th></th> <th>a</th> <th>b</th> <th>c</th> <th>d</th> </tr> </thead> <tbody> <tr> <td>① Socket</td> <td></td> <td></td> <td>34.8</td> <td></td> </tr> <tr> <td>① Plug</td> <td></td> <td></td> <td>40</td> <td></td> </tr> <tr> <td>② Socket</td> <td></td> <td></td> <td>40.1</td> <td></td> </tr> <tr> <td>② Plug</td> <td></td> <td></td> <td>39.5</td> <td></td> </tr> <tr> <td>③ Socket</td> <td></td> <td></td> <td>40.1</td> <td></td> </tr> <tr> <td>③ Plug</td> <td></td> <td></td> <td>39.5</td> <td></td> </tr> <tr> <td>④ Socket</td> <td></td> <td></td> <td>43.1</td> <td></td> </tr> <tr> <td>④ Plug</td> <td></td> <td></td> <td>40.8</td> <td></td> </tr> </tbody> </table>						a	b	c	d	① Socket			34.8		① Plug			40		② Socket			40.1		② Plug			39.5		③ Socket			40.1		③ Plug			39.5		④ Socket			43.1		④ Plug			40.8	
	a	b	c	d																																																					
① Socket			34.8																																																						
① Plug			40																																																						
② Socket			40.1																																																						
② Plug			39.5																																																						
③ Socket			40.1																																																						
③ Plug			39.5																																																						
④ Socket			43.1																																																						
④ Plug			40.8																																																						
			0.5 / 20	CK1,6-ED-0,50... AG	1663404	1663349	100																																																		
			0.75 / 18	CK1,6-ED-0,75... AG	1663417	1663352	100																																																		
			0.75 - 1 / 18	CK1,6-ED-1,00... AG	1663420	1663365	100																																																		
			1.5 / 16	CK1,6-ED-1,50... AG	1663433	1663378	100																																																		
			2.5 / 14	CK1,6-ED-2,50... AG	1663446	1663381	100																																																		
Turned crimp contacts CK 2,5 Silver-plated																																																									
			Cross section mm ² / AWG																																																						
			0.5 / 20	CK2,5-ED-0,50... AG	1663640	1663572	100																																																		
			0.75 / 18	CK2,5-ED-0,75... AG	1663653	1663585	100																																																		
			0.75 - 1 / 18	CK2,5-ED-1,00... AG	1663666	1663598	100																																																		
			1.5 / 16	CK2,5-ED-1,50... AG	1663679	1663608	100																																																		
			2.5 / 14	CK2,5-ED-2,50... AG	1663682	1663611	100																																																		

Accessories



HC-HS 2... coding profile
From page 638



CK 2,5 dummy socket
From page 639



HC-D 7... coding profile
From page 638



HC-Q 12... coding profile
From page 638

Heavy-duty connectors

HEAVYCON D7 - housing

Size D7, plastic, sleeve housing for single locking latch





General data

Housing material
Locking latch material
Sealing material
Ambient temperature (operation)
IP degree of protection (when plugged in)

Technical data	
Housing material	Polyamide
Locking latch material	-
Sealing material	-
Ambient temperature (operation)	-40 °C ... 125 °C
IP degree of protection (when plugged in)	IP54 / IP65

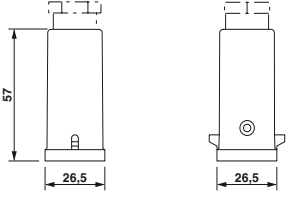
Ordering data

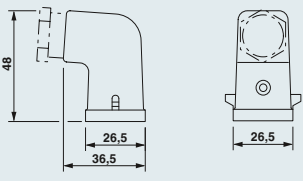
Description	Thread	Type	Order No.	Pcs. / Pkt.	Dimensions
Sleeve housing Height: 57 mm 	1x M20	Light gray, cable outlet: top HC-D 7-TFL-57/O1M20G/PA HC-D 7-TFL-57/O1PG11G/PA	1604889	10	
	1x Pg11		Black, cable outlet: top HC-D 7-TFL-57/O1M20G/PA BK	1675450	
	1x M20		1410673	10	
Sleeve housing Height: 48 mm 	1x M20	Light gray, cable outlet: lateral HC-D 7-TFL-48/O1M20S/PA HC-D 7-TFL-49/O1PG11S/PA	1604890	10	
	1x Pg11		Black, cable outlet: lateral HC-D 7-TFL-48/O1M20S/PA BK	1675463	
	1x M20		1413510	10	

Notes:
For further accessories, see page 642

Accessories

 Cable glands From page 680	 Replacement sealing screw, IP65 From page 653	 Replacement latch From page 652
---	--	--

Size D7, metal, sleeve housing for single locking latch

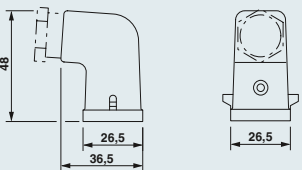

General data		Technical data	
Housing material		Zinc die-cast	
Surface material		Powder-coated, gray	
Locking latch material		-	
Sealing material		-	
Ambient temperature (operation)		-40 °C ... 125 °C	
IP degree of protection (when plugged in)		IP54 / IP65	

Description		Thread		Type		Order No.		Pcs. / Pkt.		Dimensions	
Sleeve housing Height: 57 mm 	1x M20	1x Pg11	Cable outlet: top		1604888 1660627	10	10				
			HC-D 7-TFL-57/O1M20G HC-D 7-TFL-57/O1PG11G								
Sleeve housing Height: 48 mm 	1x M20	1x Pg11	Cable outlet: lateral		1604891 1672932	10	10				
			HC-D 7-TFL-48/O1M20S HC-D 7-TFL-48/O1PG11S								

Notes:
For further accessories, see page 642

Accessories



Cable glands
From page 680



Replacement sealing screw, IP65
From page 653

Heavy-duty connectors

HEAVYCON D7 - housing

Size D7, plastic, supporting base element with single locking latch

General data







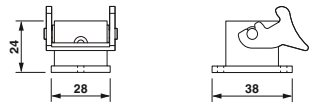

Housing material
Locking latch material
Sealing material
Ambient temperature (operation)
IP degree of protection (when plugged in)

Technical data

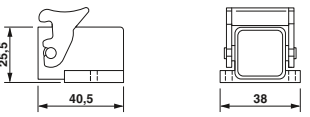
Polyamide
Polyamide
NBR
-40 °C ... 125 °C
IP54 / IP65

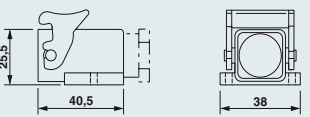

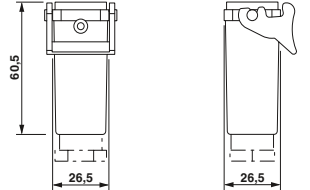
Ordering data

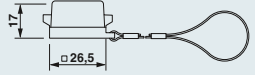
Description	Thread	Type	Order No.	Pcs. / Pkt.	Dimensions
Panel mounting base Height: 24 mm 		Light gray, without cover HC-D 7-AML-24/GR/PA Black, without cover HC-D 7-AML-24/GR/PA BK	1772272 1413112	10 10	
Panel mounting base Height: 25.5 mm 		Light gray, angled version HC-D 7-AML-26/GW/PA Black, angled version HC-D 7-AML-26/GW/PA BK	1772285 1410686	10 10	
Box mounting base Height: 25.5 mm 	1x M20 1x Pg11 1x M20	Light gray HC-D 7-SML-26/O1STM20/PA HC-D7-SML-57/O1STPG11/PA Black HC-D 7-SML-26/O1STM20/PA BK	1674886 1416405 1413717	10 10 10	
Coupling housing Height: 60.5 mm 	1x M20 1x Pg11 1x M20	HC-D 7-KML-61/O1M20/PA HC-D 7-KML-51/O1PG11/PA Black HC-D 7-KML-61/O1M20/PA BK	1604884 1675434 1413718	10 10 10	
Protective cover, plastic 		Socket HC-D 7-SD-FL/FS-MD Plug HC-D 7-SD-FL/FS	1644300 1772573	10 10	

Notes:

For further accessories, see page 642

Accessories



Cable glands
From page 680



Replacement sealing screw, IP65
From page 653



Replacement seals
From page 651











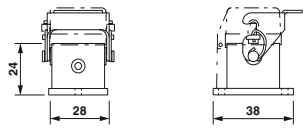

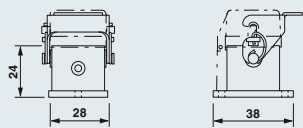
Replacement latch
From page 652

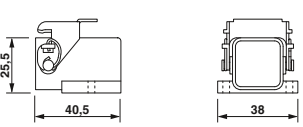
Size D7, metal, supporting base element with single locking latch

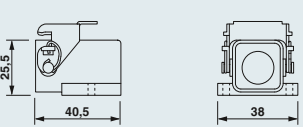

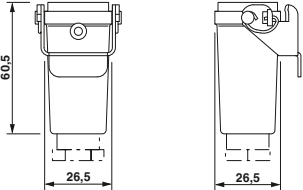
General data		Technical data	
Housing material		Zinc die-cast	
Surface material		Powder-coated, gray (metal housing)	
Locking latch material		Steel, galvanized and passivated	
Sealing material		NBR	
Ambient temperature (operation)		-40 °C ... 125 °C	
IP degree of protection (when plugged in)		IP54 / IP65	

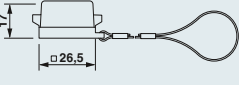
Description		Thread	Type	Order No.	Pcs. / Pkt.	Dimensions
Panel mounting base Height: 24 mm 			Without cover HC-D 7-AML-24/GR	1773035	10	
Panel mounting base Height: 24 mm 			With metal cover, socket HC-D 7-AMLD-24/GR With metal cover, plug HC-D 7-AMLD-24/GR-OD	1676970 1684994	10 10	
Panel mounting base Height: 25.5 mm 			Angled version HC-D 7-AML-26/GW	1773022	10	
Box mounting base Height: 25.5 mm 		1x M20 1x Pg11	HC-D 7-SML-26/O1STM20 HC-D7-SML-26/O1STPG11	1674899 1416406	10 10	
Coupling housing Height: 60.5 mm 		1x M20 1x Pg11	HC-D 7-KML-61/O1M20 HC-D 7-KML-61/O1PG11	1604883 1672893	10 10	
Protective cover, plastic 			Socket HC-D 7-SD-FL/FS-MD Plug HC-D 7-SD-FL/FS	1644300 1772573	10 10	

Notes:
For further accessories, see page 642

Accessories



Cable glands
From page 680

Replacement sealing screw, IP65
From page 653

Replacement seals
From page 651

Heavy-duty connectors

HEAVYCON D - contact inserts

A10 series

250 V, 16 - 20 A

Connection technology:

- Screw connection
- Crimp connection

To determine the corresponding housing, see cross-reference list on page 482.

Notes:
For accessories, see from page 634
A10 series with wire protection
Order crimp contacts separately
Only operate connectors when there is no load/the power is switched off
For assembly instructions, see phoenixcontact.net/products
For connection technologies, see page 4



Technical data				
Type		① HC-A 10-I-UT...	② HC-A 10-E...C	
Approvals		-	UL, VDE, TÜV, etc.	
IEC data				
Rated current, contacts (at 40°C)	A	20	16	
Surge voltage category		III	III	
Pollution degree		3	3	
Rated voltage (III/3) contacts	V	250	250	
Rated surge voltage, contacts	kV	4	4	
Connection cross section	mm ²	0.5 ... 2.5	0.5 ... 4	
UL data				
Rated voltage	V	-	600	
Rated current	A	-	-	
Connection cross section	AWG	-	-	
CSA / cUL data				
Rated voltage	V	-	600	
Rated current	A	-	10	
Connection cross section	AWG	-	20-13	
Material data				
Contact carrier material		PC	PA	
Inflammability class in acc. with UL 94		V0	V0	
Contact material		Copper alloy	Copper alloy	
Contact surface material		Ag	Ag (alternatively Au)	
Temperature data				
Ambient temperature range	°C	-40 ... 125	-40 ... 125	
General data				
Connection method		Screw connection	Crimp connection	
Stripping length	mm	7	8	
No. of pos.		10	10	
Contact numbering		1 - 16	1 - 10	
Insertion/withdrawal cycles		≥ 500	≥ 500	

Derating curves

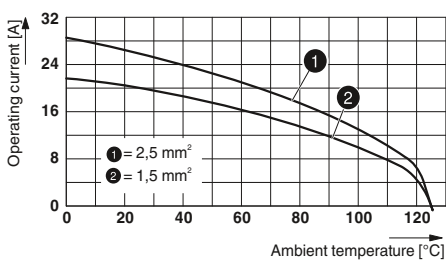

HC-A 10...-I-UT...

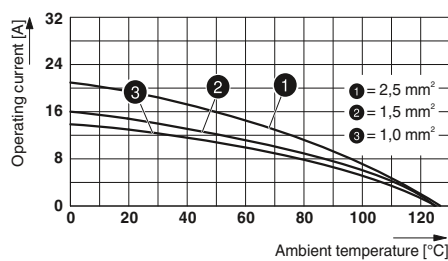

HC-A 10-E...C

Description	Pos.	Number	Size	Ordering data				
				Type	Order No. Socket	Order No. Plug	Pcs. / Pkt.	
Screw connection 	10	1 - 16	D15	① HC-A 10-I-UT...	1585304	1585294	1	
Crimp connection 	10	1 - 10	D15	② HC-A 10-E...C	1676983	1676996	10	
Turned crimp contacts CK 2,5 Silver-plated				Cross section mm² / AWG 0.5 / 20 0.75 / 18 0.75 - 1 / 16 1.5 / 16 2.5 / 14 4 / 12	CK2,5-ED-0,50... AG CK2,5-ED-0,75... AG CK2,5-ED-1,00... AG CK2,5-ED-1,50... AG CK2,5-ED-2,50... AG CK2,5-ED-4,00... AG	1663640 1663653 1663666 1663679 1663682 1663705	1663572 1663585 1663598 1663608 1663611 1663637	100 100 100 100 100 100
Turned crimp contacts CK 2,5 Gold-plated				Cross section mm² / AWG 0.5 / 20 0.75 - 1 / 18 1.5 / 16 2.5 / 14 4 / 12	CK2,5-ED-0,50... AU CK2,5-ED-1,00... AU CK2,5-ED-1,50... AU CK2,5-ED-2,50... AU CK2,5-ED-4,00... AU	1674859 1674833 1674820 1674862 1674846	1674804 1674781 1674778 1674817 1674794	100 100 100 100 100

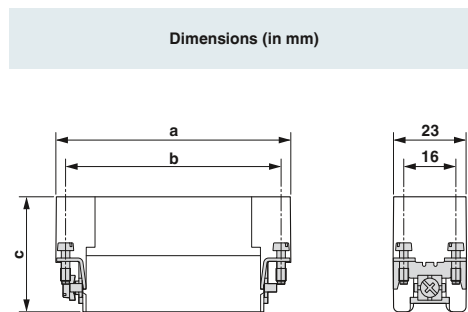

Dimensional drawing

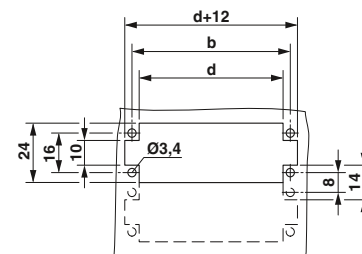

Panel cutout

	a	b	c	d
① Socket			31.5	43.5
① Plug	55.5	49.5	34.1	43.5
② Socket			30	43.5
② Plug	56.5	49.5	33	43.5

Accessories



Crimping tools
From page 636



Coding profiles
From page 638



Coding elements
From page 639



Replacement PE screws
From page 640

Heavy-duty connectors

HEAVYCON D - contact inserts

A16 series

250 V, 16 - 20 A

Connection technology:

- Screw connection
- Crimp connection

To determine the corresponding housing, see cross-reference list on page 482.

Notes:
For accessories, see from page 634
A16 series with wire protection
Order crimp contacts separately
Only operate connectors when there is no load/the power is switched off
For assembly instructions, see phoenixcontact.net/products
For connection technologies, see page 4



Technical data				
Type		① ② HC-A 16-I-UT-...	③ ④ HC-A 16-E...C	
Approvals		-	UL, VDE, IEC	
IEC data				
Rated current, contacts (at 40°C)	A	20	16	
Surge voltage category		III	III	
Pollution degree		3	3	
Rated voltage (III/3) contacts	V	250	250	
Rated surge voltage, contacts	kV	4	4	
Connection cross section	mm ²	0.5 ... 2.5	0.5 ... 4	
UL data				
Rated voltage	V	-	600	
Rated current	A	-	-	
Connection cross section	AWG	-	-	
CSA / cUL data				
Rated voltage	V	-	600	
Rated current	A	-	10	
Connection cross section	AWG	-	20-13	
Material data				
Contact carrier material		PC	PA	
Inflammability class in acc. with UL 94		V0	V0	
Contact material		Copper alloy	Copper alloy	
Contact surface material		Ag	Ag (alternatively Au)	
Temperature data				
Ambient temperature range	°C	-40 ... 125	-40 ... 125	
General data				
Connection method		Screw connection	Crimp connection	
Stripping length	mm	7	8	
No. of pos.		16	16	
Contact numbering		1 - 16	1 - 16	
Insertion/withdrawal cycles		≥ 500	≥ 500	



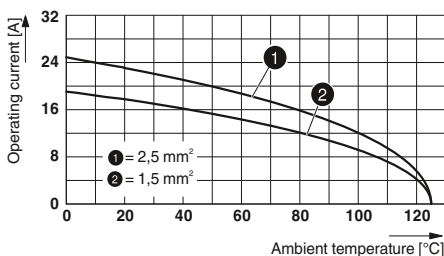

Derating curves

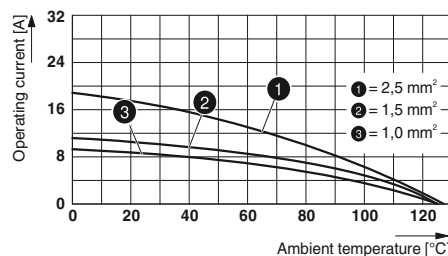

HC-A 16-I-UT-...



HC-A 16-E...C

Description	Pos.	Number	Size	Type	Ordering data		Pcs. / Pkt.
					Socket	Plug	
Screw connection							
	16	1 - 16	D25 / D50	① HC-A 16-I-UT-...	1585320	1585317	1
	16	17 - 32	D25 / D50	② HC-A 16-I-UT-...-32	1585346	1585333	1
Crimp connection							
	16	1 - 16	D25 / D50	③ HC-A 16-E...C	1677018	1677034	10
	16	17 - 32	D25 / D50	④ HC-A 16-E...C-32	1677050	1677076	10
Turned crimp contacts CK 2,5 Silver-plated							
			Cross section mm ² / AWG	CK2,5-ED-0,50... AG	1663640	1663572	100
			0.5 / 20	CK2,5-ED-0,75... AG	1663653	1663585	100
			0.75 / 18	CK2,5-ED-1,00... AG	1663666	1663598	100
			0.75 - 1 / 16	CK2,5-ED-1,50... AG	1663679	1663608	100
			1.5 / 16	CK2,5-ED-2,50... AG	1663682	1663611	100
			2.5 / 14	CK2,5-ED-4,00... AG	1663705	1663637	100
		4 / 12					
Turned crimp contacts CK 2,5 Gold-plated							
			Cross section mm ² / AWG	CK2,5-ED-0,50... AU	1674859	1674804	100
			0.5 / 20	CK2,5-ED-1,00... AU	1674833	1674781	100
			0.75 - 1 / 18	CK2,5-ED-1,50... AU	1674820	1674778	100
			1.5 / 16	CK2,5-ED-2,50... AU	1674862	1674817	100
			2.5 / 14	CK2,5-ED-4,00... AU	1674846	1674794	100
			4 / 12				

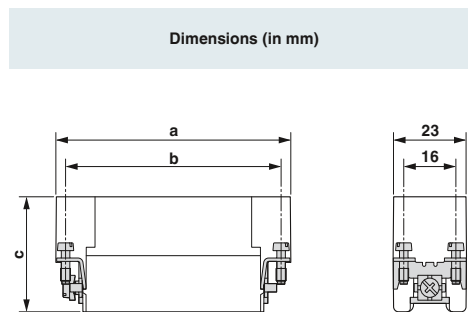

Dimensional drawing

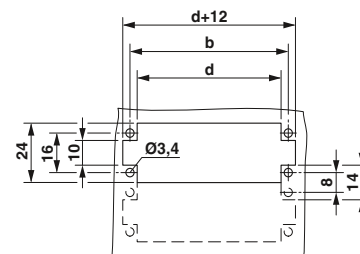

Panel cutout

	a	b	c	d
① Socket			31.5	
① Plug	72	66	34.1	60
② Socket			31.5	
② Plug	72	66	34.1	60
③ Socket			31.7	
③ Plug	72	66	31.8	60
④ Socket			31.7	
④ Plug	72	66	31.8	60

Accessories



Crimping tools
From page 636



Coding profiles
From page 638



Coding elements
From page 639



Replacement PE screws
From page 640

Heavy-duty connectors

HEAVYCON D - contact inserts

D15 series

250 V, 10 A

Connection technology:

– Crimp connection

Coding pins and sockets are mandatory for HC-D... and HC-DD series contact inserts.

To determine the corresponding housing, see cross-reference list on page 482.

Notes:
For accessories, see from page 634
Order crimp contacts separately
Only operate connectors when there is no load/the power is switched off
For assembly instructions, see phoenixcontact.net/products
For connection technologies, see page 4



		Technical data			
Type		① HC-D 15-I-CT-...			
Approvals		ERC			
IEC data					
Rated current, contacts (at 40°C)	A	10			
Surge voltage category		III			
Pollution degree		3			
Rated voltage (III/3) contacts	V	250			
Rated surge voltage, contacts	kV	4			
Connection cross section	mm ²	0.14 ... 2.5			
UL data					
Rated voltage	V	600			
Rated current	A	10			
Connection cross section	AWG	14			
CSA / cUL data					
Rated voltage	V	-			
Rated current	A	-			
Connection cross section	AWG	-			
Material data					
Contact carrier material		PC			
Inflammability class in acc. with UL 94		V0			
Contact material		Copper alloy			
Contact surface material		Ag (alternatively Au)			
Temperature data					
Ambient temperature range	°C	-40 ... 125			
General data					
Connection method		Crimp connection			
Stripping length	mm	8			
No. of pos.		15			
Contact numbering		-			
Insertion/withdrawal cycles		≥ 500			

Derating curves

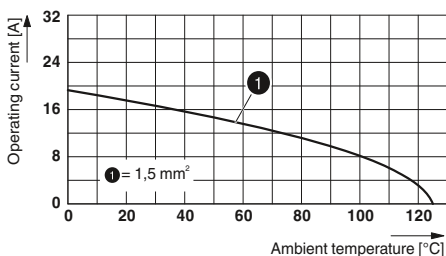

HC-D 15-I-CT-...

Description	Pos.	Number	Size	Ordering data		Pcs. / Pkt.	
				Type	Order No.		
				Socket	Plug		
Crimp connection							
	15		D15	① HC-D 15-I-CT...	1584389	1584376	10
Turned crimp contacts CK 1,6 Silver-plated							
			Cross section mm² / AWG				
			0.14 - 0.37 / 26 - 22	CK1,6-ED-0,37... AG	1663394	1663336	100
			0.5 / 20	CK1,6-ED-0,50... AG	1663404	1663349	100
			0.75 / 18	CK1,6-ED-0,75... AG	1663417	1663352	100
			0.75 - 1 / 18	CK1,6-ED-1,00... AG	1663420	1663365	100
			1.5 / 16	CK1,6-ED-1,50... AG	1663433	1663378	100
			2.5 / 14	CK1,6-ED-2,50... AG	1663446	1663381	100
Turned crimp contacts CK 1,6 Gold-plated							
			Cross section mm² / AWG				
			0.14 - 0.37 / 22 - 24	CK1,6-ED-0,37... AU	1674969	1674901	100
			0.75 / 18	CK1,6-ED-0,75... AU	1672440	1672453	100
			0.75 / 18	CK1,6-ED-0,75... AU	1672440	1674914	100
			0.75 - 1 / 18	CK1,6-ED-1,00... AU	1674943	1674888	100
			1.5 / 16	CK1,6-ED-1,50... AU	1674930	1674875	100

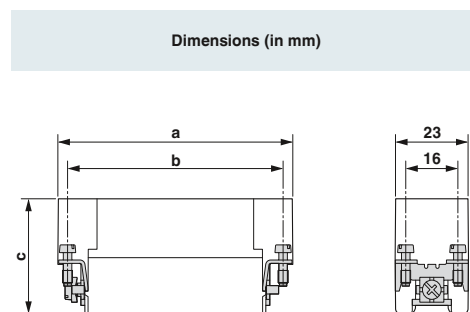

Dimensional drawing

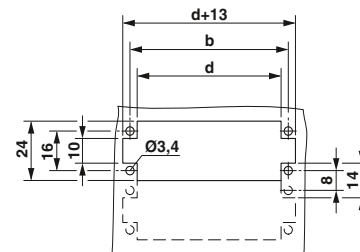

Panel cutout

	a	b	c	d
① Socket	55.4	49.5	33.5	43.5
Plug			34.2	

Accessories



Crimping tools
From page 636



Coding elements
From page 639



Replacement PE screws
From page 640

Heavy-duty connectors

HEAVYCON D - contact inserts

D25 series

250 V, 10 A

Connection technology:

– Crimp connection

Coding pins and sockets are mandatory for HC-D... and HC-DD series contact inserts.

To determine the corresponding housing, see cross-reference list on page 482.

Notes:
For accessories, see from page 634
Order crimp contacts separately
Only operate connectors when there is no load/the power is switched off
For assembly instructions, see phoenixcontact.net/products
For connection technologies, see page 4



		Technical data			
Type		① ② HC-D 25-I-CT-...			
Approvals		ERC			
IEC data					
Rated current, contacts (at 40°C)	A	10			
Surge voltage category		III			
Pollution degree		3			
Rated voltage (III/3) contacts	V	250			
Rated surge voltage, contacts	kV	4			
Connection cross section	mm ²	0.14 ... 2.5			
UL data					
Rated voltage	V	600			
Rated current	A	10			
Connection cross section	AWG	14			
CSA / cUL data					
Rated voltage	V	-			
Rated current	A	-			
Connection cross section	AWG	-			
Material data					
Contact carrier material		PC			
Inflammability class in acc. with UL 94		V0			
Contact material		Copper alloy			
Contact surface material		Ag (alternatively Au)			
Temperature data					
Ambient temperature range	°C	-40 ... 125			
General data					
Connection method		Crimp connection			
Stripping length	mm	8			
No. of pos.		25			
Contact numbering		-			
Insertion/withdrawal cycles		≥ 500			

Derating curves

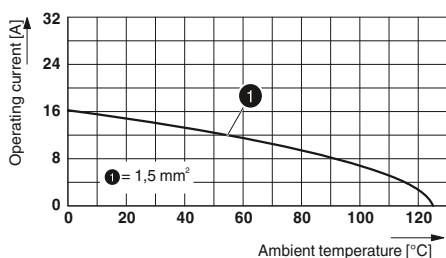

HC-D 25-I-CT-...

Description	Pos.	Number	Size	Ordering data		
				Type	Order No. Socket Plug	Pcs. / Pkt.
Crimp connection 	25	D25 / D50	① HC-D 25-I-CT-...	1584402	1584392	10
	25	D25 / D50	② HC-D 25-I-CT-...	1584402	1584392	10
<hr/>						
Turned crimp contacts CK 1,6 Silver-plated						
	Cross section mm ² / AWG		CK1,6-ED-0,37... AG CK1,6-ED-0,50... AG CK1,6-ED-0,75... AG CK1,6-ED-1,00... AG CK1,6-ED-1,50... AG CK1,6-ED-2,50... AG	1663394 1663404 1663417 1663420 1663433 1663446	1663336 1663349 1663352 1663365 1663378 1663381	100 100 100 100 100 100
	0.14 - 0.37 / 26 - 22					
	0.5 / 20					
	0.75 / 18					
	0.75 - 1 / 18					
	1.5 / 16					
<hr/>						
Turned crimp contacts CK 1,6 Gold-plated						
	Cross section mm ² / AWG		CK1,6-ED-0,37... AU CK1,6-ED-0,75... AU CK1,6-ED-0,75... AU CK1,6-ED-1,00... AU CK1,6-ED-1,50... AU	1674969 1672440 1672440 1674943 1674930	1674901 1672453 1674914 1674888 1674875	100 100 100 100 100
	0.14 - 0.37 / 22 - 24					
	0.75 / 18					
	0.75 / 18					
	0.75 - 1 / 18					
	1.5 / 16					

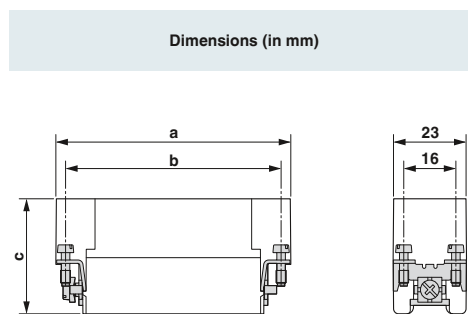

Dimensional drawing

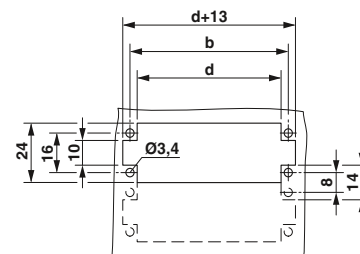

Panel cutout

	a	b	c	d
① Socket	72	66	33.5	60
① Plug			34.2	
② Socket	72	66	33.5	60
② Plug			34.2	

Accessories



Crimping tools
From page 636



Coding elements
From page 639



Replacement PE screws
From page 640

Heavy-duty connectors

HEAVYCON D - housing

Size D15, plastic, EVO sleeve housing for single locking latch









General data

Housing material	Polyamide
Locking latch material	-
Sealing material	NBR
Ambient temperature (operation)	-40 °C ... 125 °C
IP degree of protection (when plugged in)	IP66
NEMA degree of protection (when plugged in)	4 / 4X / 12

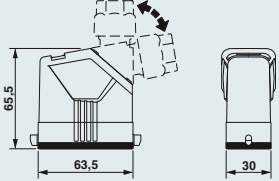
Technical data

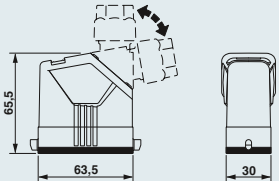
Housing material	Polyamide
Locking latch material	-
Sealing material	NBR
Ambient temperature (operation)	-40 °C ... 125 °C
IP degree of protection (when plugged in)	IP66
NEMA degree of protection (when plugged in)	4 / 4X / 12

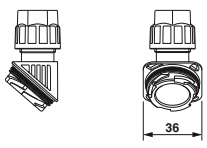
Ordering data

Description	Thread	Type	Order No.	Pcs. / Pkt.	Dimensions
Sleeve housing Height: 65.5 mm 		HC-EVO-D15-HHFS-PL-BK	1411340	1	
Sleeve housing Height: 65.5 mm 		HC-EVO-D15-HHFS-PL-BK	1411340	1	
Cable gland 	Clamping area 7 mm ... 13 mm 9 mm ... 17 mm	HC-D-G-M20-PLRBK HC-D-G-M25-PLRBK	1411350 1411351	1 1	
Connector set 		Without cover, screw connection HC-EVO-A10UT-BWS-HH-M20-PLRBK With cover, screw connection HC-EVO-A10UT-BWSC-HH-M20-PLRBK	1411356 1411357	1 1	

Notes:

For further accessories, see page 642

Marking label: US-EMP (20X9) Order No. [0829439](#)

Accessories



EVO unlocking
From page 653



Thread adapter
From page 643







Size D15, metal, sleeve housing for single locking latch

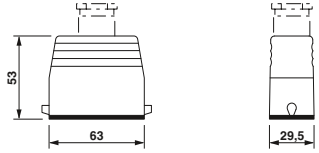

Technical data

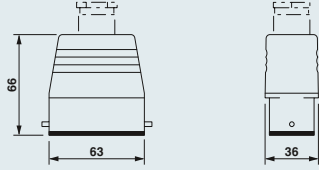
General data	
Housing material	Aluminum die-cast
Locking latch material	-
Sealing material	NBR
Ambient temperature (operation)	-40 °C ... 125 °C
IP degree of protection (when plugged in)	IP65

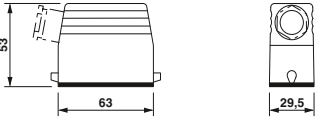
Ordering data

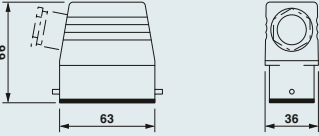
Description	Thread	Type	Order No.	Pcs. / Pkt.	Dimensions
Sleeve housing Height: 53 mm 	1x M20 1x Pg16	Cable outlet: top HC-D 15-TFL-53/O1M20G	1416379	10	
		HC-D 15-TFL-53/O1PG16G	1672741	10	
Sleeve housing Height: 66 mm 	1x M20 1x M25 1x Pg16 1x Pg21	Cable outlet: top HC-D 15-TFL-66/O1STM20G	1645163	10	
		HC-D 15-TFL-66/O1STM25G	1645176	10	
		HC-D15-TFL-66/O1PG16G	1416384	10	
		HC-D15-TFL-66/O1PG21G	1416385	10	
Sleeve housing Height: 53 mm 	1x M20 1x Pg16	Cable outlet: lateral HC-D 15-TFL-53/O1M20S	1604896	10	
		HC-D 15-TFL-53/O1PG16S	1672699	10	
Sleeve housing Height: 66 mm 	1x M20 1x M25 1x Pg16 1x Pg21	Cable outlet: lateral HC-D 15-TFL-66/O1STM20S	1636046	10	
		HC-D 15-TFL-66/O1STM25S	1636059	10	
		HC-D 15-TFL-66/O1PG16S	1672709	10	
		HC-D15-TFL-66/O1PG21S	1416386	10	

Notes:

For further accessories, see page 642

Accessories



Cable glands
From page 680



Cover plates
From page 648



D-SUB adapter plates
From page 649

Heavy-duty connectors

HEAVYCON D - housing

Size D15, plastic, EVO supporting base element with single locking latch

General data









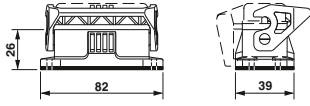

Housing material	Polyamide
Locking latch material	Polyamide
Sealing material	NBR
Ambient temperature (operation)	-40 °C ... 125 °C
IP degree of protection (when plugged in)	IP66
NEMA degree of protection (when plugged in)	4 / 4X / 12

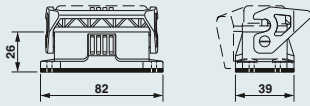
Technical data

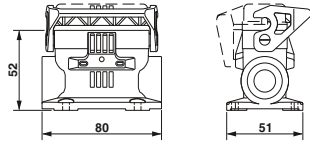
Housing material	Polyamide
Locking latch material	Polyamide
Sealing material	NBR
Ambient temperature (operation)	-40 °C ... 125 °C
IP degree of protection (when plugged in)	IP66
NEMA degree of protection (when plugged in)	4 / 4X / 12

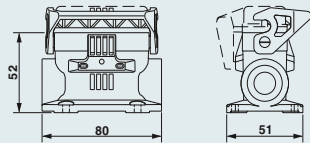

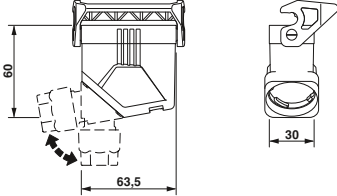
Ordering data

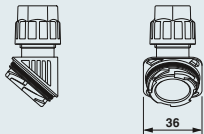
Description	Thread	Type	Order No.	Pcs. / Pkt.	Dimensions
Panel mounting base Height: 26 mm 		Without cover HC-EVO-D15-BWS-PLR-BK	1411336	1	
Panel mounting base Height: 26 mm 		With cover HC-EVO-D15-BWSC-PLR-BK	1411337	1	
Box mounting base¹⁾ Height: 52 mm 	2x M25	Without cover HC-EVO-D15-SLWS-2SSM25-PLR-BK	1411341	1	
Box mounting base¹⁾ Height: 52 mm 	2x M25	With cover HC-EVO-D15-SLWSC-2SSM25-PLR-BK	1411343	1	
Coupling housing Height: 60 mm 		HC-EVO-D15-CHWS-PL-BK	1411338	1	
Cable gland 	Clamping area 7 mm ... 13 mm 9 mm ... 17 mm	HC-D-G-M20-PLRBK HC-D-G-M25-PLRBK	1411350 1411351	1 1	

Notes:

For further accessories, see page 642

¹⁾ One cable entry is sealed with a knockout cover

Accessories



EVO unlocking
From page 653



Thread adapter
From page 643



Replacement protective cover
From page 647



Replacement latch
From page 652

Size D15, metal, supporting base element with single locking latch

General data







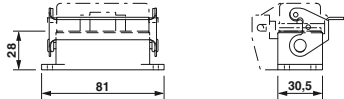

Housing material
 Locking latch material
 Sealing material
 Ambient temperature (operation)
 IP degree of protection (when plugged in)

Technical data

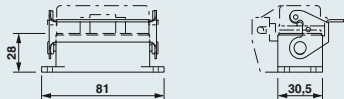
Aluminum die-cast
 Steel, galvanized
 CR
 -40 °C ... 125 °C
 IP65

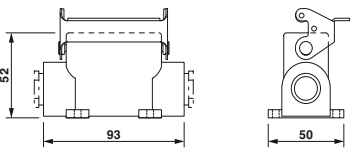

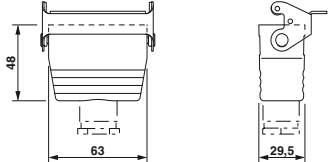
Ordering data

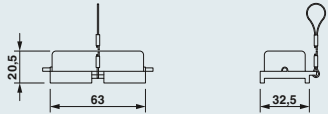
Description	Thread	Type	Order No.	Pcs. / Pkt.	Dimensions
Panel mounting base Height: 26 mm 		Without cover HC-D 15-AML	1772379	10	
Panel mounting base Height: 26 mm 		With cover HC-D 15-AMLD	1678363	10	
Box mounting base Height: 52 mm 	1x M25 1x Pg16 2x M20 2x M25 1x Pg16	Without cover HC-D 15-SML-52/O1M25 HC-D 15-SML-52/O1PG16 HC-D 15-SML-52/O2M20 HC-D 15-SML-52/O2M25 HC-D 15-SML-52/O2PG16	1604893 1672657 1604894 1604895 1672660	10 10 10 10 10	
Coupling housing Height: 48 mm 	1x M20 1x Pg16	HC-D 15-KML-48/O1M20 HC-D 15-KML-48/O1PG16	1604892 1678266	10 10	
Protective cover, plastic 		HC-D 15-SD-FL/FS	1660164	10	

Notes:

For further accessories, see page 642

Accessories



Cable glands
From page 680



Cover plates
From page 648



D-SUB adapter plates
From page 649



Replacement seals
From page 651

Heavy-duty connectors

HEAVYCON D - housing

Size D25, plastic, EVO sleeve housing for single locking latch









General data

Housing material	Polyamide
Locking latch material	-
Sealing material	NBR
Ambient temperature (operation)	-40 °C ... 125 °C
IP degree of protection (when plugged in)	IP66
NEMA degree of protection (when plugged in)	4 / 4X / 12

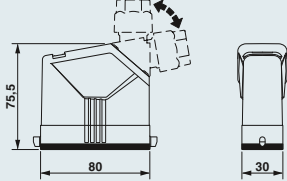
Technical data

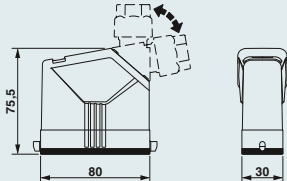
Housing material	Polyamide
Locking latch material	-
Sealing material	NBR
Ambient temperature (operation)	-40 °C ... 125 °C
IP degree of protection (when plugged in)	IP66
NEMA degree of protection (when plugged in)	4 / 4X / 12

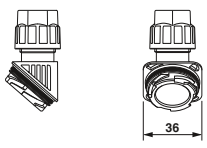
Ordering data

Description	Thread	Type	Order No.	Pcs. / Pkt.	Dimensions
Sleeve housing Height: 75.5 mm 		HC-EVO-D25-HHFS-PL-BK	1411347	1	
Sleeve housing Height: 75.5 mm 		HC-EVO-D25-HHFS-PL-BK	1411347	1	
Cable gland 	Clamping area 7 mm ... 13 mm 9 mm ... 17 mm	HC-D-G-M20-PLRBK HC-D-G-M25-PLRBK	1411350 1411351	1 1	
Connector set 		Without cover, screw connection HC-EVO-A16UT-BWS-HH-M25-PLRBK With cover, screw connection HC-EVO-A16UT-BWSC-HH-M25-PLRBK	1411358 1411359	1 1	

Notes:

For further accessories, see page 642

Marking label: US-EMP (20X9) Order No. [0829439](#)

Accessories



EVO unlocking
From page 653



Thread adapter
From page 643







Size D25, metal, sleeve housing for single locking latch

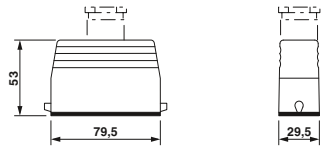

Technical data

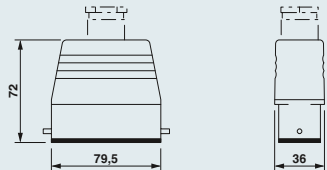
General data	
Housing material	Aluminum die-cast
Locking latch material	-
Sealing material	NBR
Ambient temperature (operation)	-40 °C ... 125 °C
IP degree of protection (when plugged in)	IP65

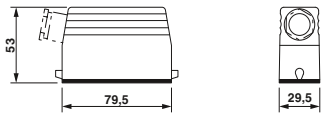
Ordering data

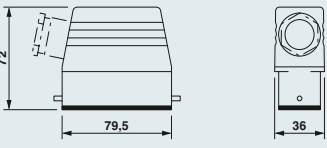
Description	Thread	Type	Order No.	Pcs. / Pkt.	Dimensions
Sleeve housing Height: 58 mm 	1x M20 1x Pg16	Cable outlet: top HC-D 25-TFL-58/O1M20G	1416380	10	
		HC-D 25-TFL-58/O1PG16G	1672819	10	
Sleeve housing Height: 72 mm 	1x M20 1x M25 1x Pg21	Cable outlet: top HC-D 25-TFL-72/O1STM20G	1636075	10	
		HC-D 25-TFL-72/O1STM25G	1645189	10	
		HC-D25-TFL-72/O1PG21G	1416387	10	
Sleeve housing Height: 58 mm 	1x M20 1x Pg16	Cable outlet: lateral HC-D 25-TFL-58/O1M20S	1416381	10	
		HC-D 25-TFL-58/O1PG16S	1672822	10	
Sleeve housing Height: 72 mm 	1x M20 1x M25 1x Pg16 1x Pg21	Cable outlet: lateral HC-D 25-TFL-72/O1STM20S	1636062	10	
		HC-D 25-TFL-72/O1STM25S	1645273	10	
		HC-D 25-TFL-72/O1PG16S	1672851	10	
		HC-D 25-TFL-72/O1PG21S	1672864	10	

Notes:

For further accessories, see page 642

Accessories



Cable glands
From page 680



Cover plates
From page 648

Heavy-duty connectors

HEAVYCON D - housing

Size D25, plastic, EVO supporting base element with single locking latch









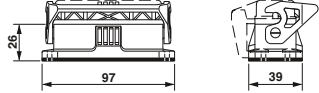

General data

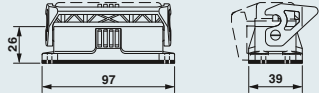
Housing material
Locking latch material
Sealing material
Ambient temperature (operation)
IP degree of protection (when plugged in)
NEMA degree of protection (when plugged in)

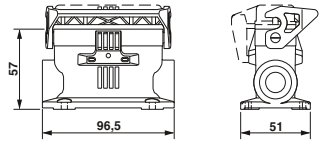
Technical data
Polyamide
Polyamide
NBR
-40 °C ... 125 °C
IP66
4 / 4X / 12

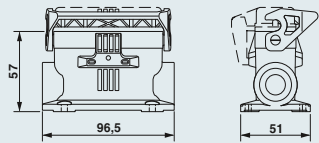

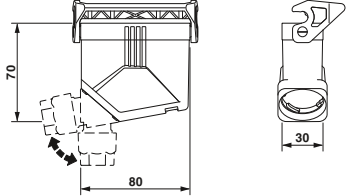
Ordering data

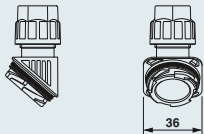
Description	Thread	Type	Order No.	Pcs. / Pkt.	Dimensions
Panel mounting base Height: 26 mm 		Without cover HC-EVO-D25-BWS-PLR-BK	1411344	1	
Panel mounting base Height: 26 mm 		With cover HC-EVO-D25-BWSC-PLR-BK	1411345	1	
Box mounting base¹⁾ Height: 57 mm 	2x M25	Without cover HC-EVO-D25-SLWS-2SSM25-PLR-BK	1411348	1	
Box mounting base¹⁾ Height: 57 mm 	2x M25	With cover HC-EVO-D25-SLWSC-2SSM25-PLR-BK	1411349	1	
Coupling housing Height: 70 mm 		HC-EVO-D25-CHWS-PLR-BK	1411346	1	
Cable gland 	Clamping area 7 mm ... 13 mm 9 mm ... 17 mm	HC-D-G-M20-PLRBK HC-D-G-M25-PLRBK	1411350 1411351	1 1	

Notes:

For further accessories, see page 642

¹⁾ One cable entry is sealed with a knockout cover

Accessories



EVO unlocking
From page 653



Thread adapter
From page 643



Replacement protective cover
From page 647



Replacement latch
From page 652

Size D25, metal, supporting base element with single locking latch

General data









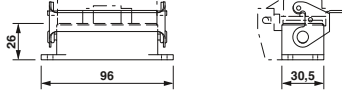

Housing material
Locking latch material
Sealing material
Ambient temperature (operation)
IP degree of protection (when plugged in)

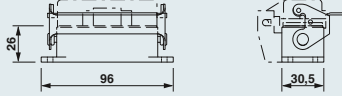
Technical data

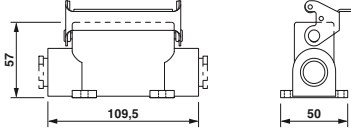
Aluminum die-cast
Steel, galvanized
CR
-40 °C ... 125 °C
IP65

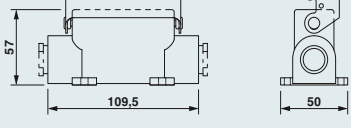

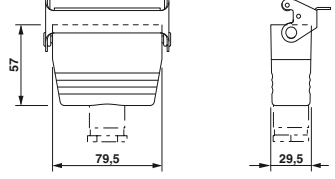
Ordering data

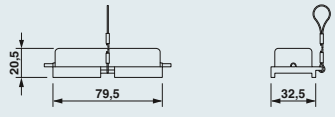
Description	Thread	Type	Order No.	Pcs. / Pkt.	Dimensions
Panel mounting base Height: 26 mm 		Without cover HC-D 25-AML	1772463	10	
Panel mounting base Height: 26 mm 		With cover HC-D 25-AML D	1672754	10	
Box mounting base Height: 57 mm 	1x M25 1x Pg16 1x Pg21 2x M20 2x M25 2x Pg16	Without cover HC-D 25-SML-57/O1M25 HC-D25-SML-57/O1PG16 HC-D25-SML-57/O1PG21 HC-D 25-SML-57/O2M20 HC-D 25-SML-57/O2M25 HC-D 25-SML-57/O2PG16	1604901 1416388 1416390 1604902 1604903 1672783	10 10 10 10 10 10	
Box mounting base Height: 57 mm 	1x Pg16 1x Pg21 2x M20 2x Pg16	With cover HC-D 25-SMLD-57/O1PG16 HC-D 25-SMLD-57/O1PG21 HC-D 25-SMLD-57/O2M20 HC-D25-SMLD-57/O2PG16	1672796 1416378 1416382 1416391	10 10 10 10	
Coupling housing Height: 57 mm 	1x M20 1x Pg16	HC-D 25-KML-53/O1M20 HC-D25-KML-53/O1PG16	1604900 1416393	10 10	
Protective cover, plastic 		HC-D 25-SD-FL/FS	1660135	10	

Notes:

For further accessories, see page 642

Accessories



Cable glands
From page 680



Cover plates
From page 648



Replacement seals
From page 651

Heavy-duty connectors

HEAVYCON D - housing

Size D50, metal, sleeve housing for double locking latch

General data



Housing material	Aluminum die-cast
Locking latch material	-
Sealing material	-
Ambient temperature (operation)	-40 °C ... 125 °C
IP degree of protection (when plugged in)	IP65

Technical data

Housing material	Aluminum die-cast
Locking latch material	-
Sealing material	-
Ambient temperature (operation)	-40 °C ... 125 °C
IP degree of protection (when plugged in)	IP65

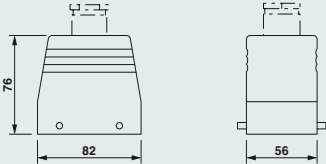

Ordering data

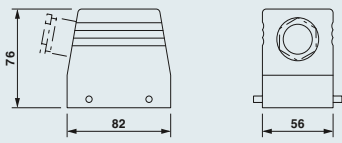
Description	Thread	Type	Order No.	Pcs. / Pkt.	Dimensions
Sleeve housing Height: 76 mm 	1x M25 1x M32 1x Pg21 1x Pg29	Cable outlet: top	1645192	10	
		HC-D 50-TFQ-76/O1STM25G	1645215	10	
		HC-D 50-TFQ-76/O1STM32G	1416394	10	
		HC-D50-TFQ-76/O1PG21G	1416395	10	
		HC-D50-TFQ-76/O1PG29G		10	
Sleeve housing Height: 76 mm 	1x M25 1x M32 1x Pg21 Pg29	Cable outlet: lateral	1645202	10	
		HC-D 50-TFQ-76/O1STM25S	1645286	10	
		HC-D 50-TFQ-76/O1STM32S	1416396	10	
		HC-D50-TFQ-76/O1PG21S	1416397	10	
		HC-D50-TFQ-76/O1PG29S		10	

Notes:

For further accessories, see page 642

Accessories



Cable glands
From page 680

Size D50, metal, supporting base element with double locking latch

General data







Housing material
Locking latch material
Sealing material
Ambient temperature (operation)
IP degree of protection (when plugged in)

Technical data

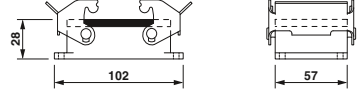
Aluminum die-cast
Steel, galvanized
NBR
-40 °C ... 125 °C
IP65

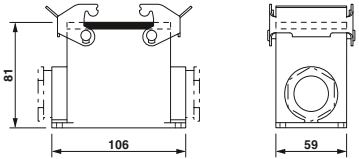

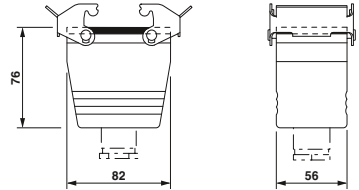
Ordering data

Description	Thread	Type	Order No.	Pcs. / Pkt.	Dimensions
Panel mounting base Height: 28 mm 		Without cover HC-D 50-AMQ	1775868	10	
Box mounting base Height: 81 mm 	1x M25 1x M32 1x Pg21 1x Pg29 2x M25 2x M32 2x Pg21 2x Pg29	HC-D 50-SMQ-81/O1M25 HC-D 50-SMQ-81/O1M32 HC-D50-SMQ-81/O1PG21 HC-D50-SMQ-81/O1PG29 HC-D 50-SMQ-81/O2M25 HC-D 50-SMQ-81/O2M32 HC-D50-SMQ-81/O2PG21 HC-D50-SMQ-81/O2PG29	1604908 1604909 1416398 1416399 1416383 1604910 1416400 1416401	10 10 10 10 10 10 10 10	
Coupling housing Height: 76 mm 	1x M25 1x M32 1x Pg21 1x Pg29	HC-D 50-KMQ-76/O1M25 HC-D 50-KMQ-76/O1M32 HC-D50-KMQ-76/O1PG21 HC-D50-KMQ-76/O1PG29	1604970 1604971 1416403 1416404	10 10 10 10	
Protective cover, plastic 		HC-D 50-SD-FQ/FS	1660193	10	

Notes:

For further accessories, see page 642

Accessories



Cable glands
From page 680



Replacement seals
From page 651

Heavy-duty connectors

HEAVYCON B - contact inserts

D40, D64 series

250 V, 10 A

Connection technology:

– Crimp connection

Coding pins and sockets are mandatory for HC-D... and HC-DD series contact inserts.

To determine the corresponding housing, see cross-reference list on page 482.

Notes:
For accessories, see from page 634
Order crimp contacts separately
Only operate connectors when there is no load/the power is switched off
For assembly instructions, see phoenixcontact.net/products
For connection technologies, see page 4



Type	Technical data			
	① HC-D 40-I-CT-...		② HC-D 64-I-CT-...	
Approvals	ERC		ERC	
IEC data				
Rated current, contacts (at 40°C)	A	10	10	
Surge voltage category		III	III	
Pollution degree		3	3	
Rated voltage (III/3) contacts	V	250	250	
Rated surge voltage, contacts	kV	4	4	
Connection cross section	mm ²	0.14 ... 2.5	0.14 ... 2.5	
UL data				
Rated voltage	V	600	600	
Rated current	A	10	10	
Connection cross section	AWG	14	14	
CSA / cUL data				
Rated voltage	V	-	-	
Rated current	A	-	-	
Connection cross section	AWG	-	-	
Material data				
Contact carrier material		PC	PC	
Inflammability class in acc. with UL 94		V0	V0	
Contact material		Copper alloy	Copper alloy	
Contact surface material		Ag (alternatively Au)	Ag (alternatively Au)	
Temperature data				
Ambient temperature range	°C	-40 ... 125	-40 ... 125	
General data				
Connection method		Crimp connection	Crimp connection	
Stripping length	mm	8	8	
No. of pos.		40	64	
Contact numbering		-	-	
Insertion/withdrawal cycles		≥ 500	≥ 500	

Derating curves

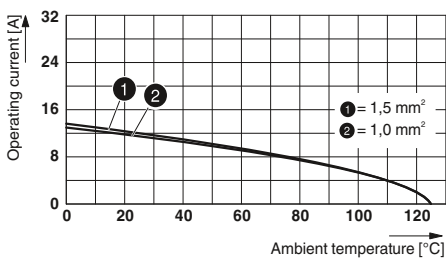

HC-D 40-I-CT-... / HC-D 64-I-CT-...

Description	Pos.	Number	Size	Ordering data		
				Type	Order No. Socket	Order No. Plug
Crimp connection 	40	B16 / B32	① HC-D 40-I-CT-...	1584428	1584415	10
Crimp connection 	64	B24 / B48	② HC-D 64-I-CT-...	1584444	1584431	10
Turned crimp contacts CK 1,6 Silver-plated 		Cross section mm² / AWG 0.14 - 0.37 / 26 - 22 0.5 / 20 0.75 / 18 0.75 - 1 / 18 1.5 / 16 2.5 / 14	CK1,6-ED-0,37... AG CK1,6-ED-0,50... AG CK1,6-ED-0,75... AG CK1,6-ED-1,00... AG CK1,6-ED-1,50... AG CK1,6-ED-2,50... AG	1663394 1663404 1663417 1663420 1663433 1663446	1663336 1663349 1663352 1663365 1663378 1663381	100 100 100 100 100 100
Turned crimp contacts CK 1,6 Gold-plated 		Cross section mm² / AWG 0.14 - 0.37 / 22 - 24 0.75 / 18 0.75 / 18 0.75 - 1 / 18 1.5 / 16	CK1,6-ED-0,37... AU CK1,6-ED-0,75... AU CK1,6-ED-0,75... AU CK1,6-ED-1,00... AU CK1,6-ED-1,50... AU	1674969 1672440 1672440 1674943 1674930	1674901 1672453 1674914 1674888 1674875	100 100 100 100 100

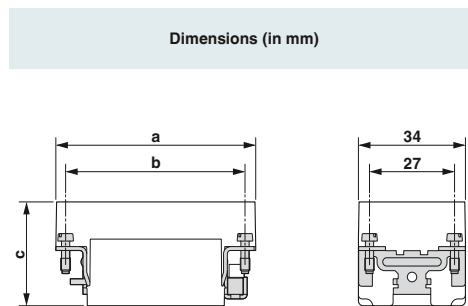

Dimensional drawing

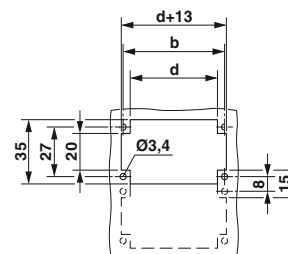

Panel cutout

	a	b	c	d
① Socket	83.5	77.5	34.2	72
① Plug			32.8	
② Socket	110.5	104.5	34.2	98
② Plug			32.8	

Accessories



Crimping tools
From page 636



Coding elements
From page 639



Replacement PE screws
From page 640

Heavy-duty connectors

HEAVYCON B - contact inserts

D40, D64 series Terminal adapters

250 V, 10 A

Connection technology:
– Screw connection

Notes:
For accessories, see from page 634
Not for HC-EVO panel mounting bases
Only operate connectors when there is no load/the power is switched off
For assembly instructions, see phoenixcontact.net/products
For connection technologies, see page 4



Type	Technical data			
	① ② HC-D 40-A-UT-PEL-...	PE left	③ ④ HC-D 64-A-UT-PEL-...	PE left
Approvals		ERC		ERC
IEC data				
Rated current, contacts (at 40°C)	A	10	10	
Surge voltage category		III	III	
Pollution degree		3	3	
Rated voltage (III/3) contacts	V	250	250	
Rated surge voltage, contacts	kV	4	4	
Connection cross section	mm ²	0.5 ... 2.5	0.2 ... 2.5	
UL data				
Rated voltage	V	-	-	
Rated current	A	-	-	
Connection cross section	AWG	-	-	
CSA / cUL data				
Rated voltage	V	-	-	
Rated current	A	-	-	
Connection cross section	AWG	-	-	
Material data				
Contact carrier material		PA	PA	
Inflammability class in acc. with UL 94		V0	V0	
Contact material		Copper alloy	Copper alloy	
Contact surface material		Ag	Ag	
Temperature data				
Ambient temperature range	°C	-40 ... 125	-40 ... 125	
General data				
Connection method		Screw connection	Screw connection	
Stripping length	mm	10	10	
No. of pos.		40	64	
Contact numbering		-	-	
Insertion/withdrawal cycles		≥ 500	≥ 500	

Derating curves

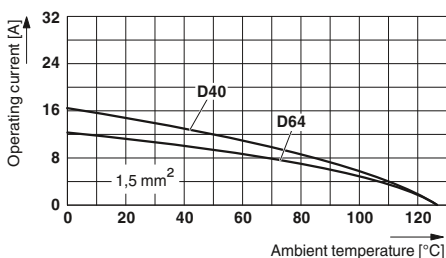

HC-D 40-A-UT-PER-.../HC-D 40-A-UT-PER-...

Heavy-duty connectors

HEAVYCON B - contact inserts

D40, D64 series TWIN terminal adapters

250 V, 10 A

- Connection technology:
 – Push-in connection
 – For 2 wires per position

Notes:
For accessories, see from page 634
Not for HC-EVO panel mounting bases
Only operate connectors when there is no load/the power is switched off
For assembly instructions, see phoenixcontact.net/products
For connection technologies, see page 4



Type	Technical data	
	①② HC-D 40-A-TWIN-PEL-...	③④ HC-D 64-A-TWIN-PEL-...
Approvals	PE left EAC	PE left EAC
IEC data		
Rated current, contacts (at 40°C)	A	10
Surge voltage category	III	III
Pollution degree	3	3
Rated voltage (III/3) contacts	V	250
Rated surge voltage, contacts	kV	6
Connection cross section	mm ²	0.5 ... 2.5
UL data		
Rated voltage	V	-
Rated current	A	-
Connection cross section	AWG	-
CSA / cUL data		
Rated voltage	V	-
Rated current	A	-
Connection cross section	AWG	-
Material data		
Contact carrier material	PA	PA
Inflammability class in acc. with UL 94	V0	V0
Contact material	Copper alloy	Copper alloy
Contact surface material	Ag	Ag
Temperature data		
Ambient temperature range	°C	-40 ... 125
General data		
Connection method	Push-in connection	Push-in connection
Stripping length	mm	10
No. of pos.	40	64
Contact numbering	-	-
Insertion/withdrawal cycles	≥ 500	≥ 500

Derating curves

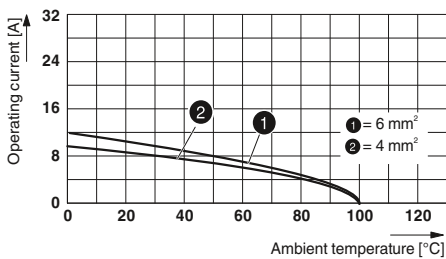

HC-D 40-A-TWIN-PER-...

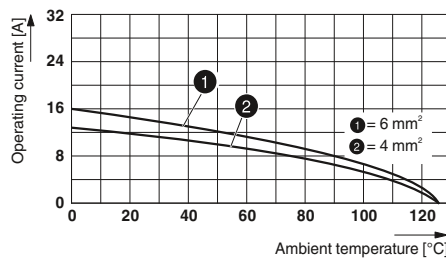

HC-D 64-A-TWIN-PER-...

Heavy-duty connectors

HEAVYCON B - contact inserts

DD24, DD42, DD72, DD108 series

250 V, 10 A

Connection technology:

– Crimp connection

Coding pins and sockets are mandatory for HC-D... and HC-DD series contact inserts.

To determine the corresponding housing, see cross-reference list on page 482.

Notes:
For accessories, see from page 634
Order crimp contacts separately
Only operate connectors when there is no load/the power is switched off
For assembly instructions, see phoenixcontact.net/products
For connection technologies, see page 4



Technical data					
Type		① HC-DD24-I-CT-...	② HC-DD42-I-CT-...	③ ④ HC-DD72-I-CT-...	⑤ ⑥ HC-DD108-I-CT-...
Approvals					
IEC data					
Rated current, contacts (at 40°C)	A	10	10	10	10
Surge voltage category		III	III	III	III
Pollution degree		3	3	3	3
Rated voltage (III/3) contacts	V	250	250	250	250
Rated surge voltage, contacts	kV	4	4	4	4
Connection cross section	mm ²	0.14 ... 2.5	0.14 ... 2.5	0.14 ... 2.5	0.14 ... 2.5
UL data					
Rated voltage	V	250	250	250	250
Rated current	A	10	10	10	10
Connection cross section	AWG	14	14	14	14
CSA / cUL data					
Rated voltage	V	250	250	250	250
Rated current	A	7	7	7	7
Connection cross section	AWG	26-14	26-14	26-14	26-14
Material data					
Contact carrier material		PC	PC	PC	PC
Inflammability class in acc. with UL 94		V0	V0	V0	V0
Contact material		Copper alloy	Copper alloy	Copper alloy	Copper alloy
Contact surface material		Ag (alternatively Au)	Ag (alternatively Au)	Ag (alternatively Au)	Ag (alternatively Au)
Temperature data					
Ambient temperature range	°C	-40 ... 125	-40 ... 125	-40 ... 125	-40 ... 125
General data					
Connection method		Crimp connection	Crimp connection	Crimp connection	Crimp connection
Stripping length	mm	8	8	8	8
No. of pos.		24	42	72	108
Contact numbering		1 - 24	1 - 42	1 - 72	1 - 108
Insertion/withdrawal cycles		≥ 500	≥ 500	≥ 500	≥ 500

Derating curves

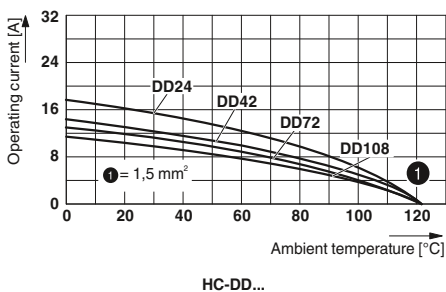

Description	Pos.	Number	Size	Ordering data			
				Type	Order No. Socket	Order No. Plug	Pcs. / Pkt.
Crimp connection 	24	1 - 24	B6	① HC-DD24-I-CT-...	1584046	1584033	10
Crimp connection 	42	1 - 42	B10	② HC-DD42-I-CT-...	1584062	1584059	10
Crimp connection 	72	1 - 72	B16 / B32	③ HC-DD72-I-CT-...	1584091	1584075	10
	72	73 - 144	B16 / B32	④ HC-DD72-I-CT-...-144	1584101	1584088	10
Crimp connection 	108	1 - 108	B24 / B48	⑤ HC-DD108-I-CT-...	1584130	1584114	10
	108	109 - 216	B24 / B48	⑥ HC-DD108-I-CT-...-216	1584143	1584127	10
Turned crimp contacts CK 1,6 Silver-plated 			Cross section mm ² / AWG				
			0.14 - 0.37 / 26 - 22	CK1,6-ED-0,37... AG	1663394	1663336	100
			0.5 / 20	CK1,6-ED-0,50... AG	1663404	1663349	100
			0.75 / 18	CK1,6-ED-0,75... AG	1663417	1663352	100
			0.75 - 1 / 18	CK1,6-ED-1,00... AG	1663420	1663365	100
			1.5 / 16	CK1,6-ED-1,50... AG	1663433	1663378	100

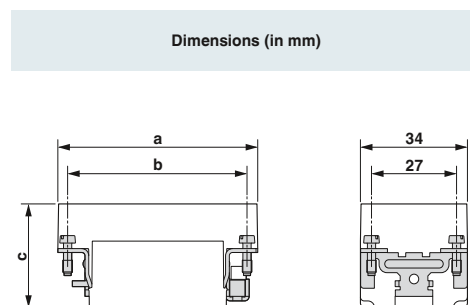

Dimensional drawing

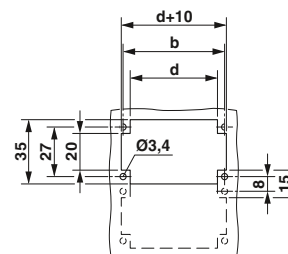

Panel cutout

	a	b	c	d
① Socket	50.5	44	34.5	36
① Plug			32.5	
② Socket	64	57	34.5	49
② Plug			32.5	
③ Socket	84	77.5	34.5	72
③ Plug			32.5	
④ Socket	84	77.5	34.5	72
④ Plug			32.5	
⑤ Socket	111	104	34.5	98
⑤ Plug			32.5	
⑥ Socket	111	104	34.5	98
⑥ Plug			32.5	

Accessories



Crimping tools
From page 636



Coding elements
From page 639



Crimp contacts, gold-plated
phoenixcontact.net/products



Replacement PE screws
From page 640

Heavy-duty connectors

HEAVYCON B - contact inserts

B6 series

500 V, 16 A

Connection technology:

- Screw connection
- Push-in connection
- Insulation displacement connection
- Crimp connection

To determine the corresponding housing, see cross-reference list on page 482.

Notes:
For accessories, see from page 634
Order crimp contacts separately
Only operate connectors when there is no load/the power is switched off
For assembly instructions, see phoenixcontact.net/products
For connection technologies, see page 4



Technical data					
Type		① HC-B 6-I-UT...	② HC-B 6-I-PT...	③ HC-B 6-E...Q-2,5	④ HC-B 6-I-CT...
Approvals					
IEC data					
Rated current, contacts (at 40°C)	A	16	16	16	16
Surge voltage category		III	III	III	III
Pollution degree		3	3	3	3
Rated voltage (III/3) contacts	V	500	500	400	500
Rated surge voltage, contacts	kV	6	6	6	6
Connection cross section	mm ²	0.5 ... 2.5	0.14 ... 2.5	0.34 ... 2.5	0.5 ... 4
UL data					
Rated voltage	V	600	600	600	600
Rated current	A	13	13	10	13
Connection cross section	AWG	22-14	14	14	22-14
CSA / cUL data					
Rated voltage	V	600	600	600	600
Rated current	A	13	13	10	20
Connection cross section	AWG	22-14	14	16	20-12
Material data					
Contact carrier material		PA	PA	PA	PA
Inflammability class in acc. with UL 94		V0	V0	V0	V0
Contact material		Copper alloy	Copper alloy	Copper alloy	Copper alloy
Contact surface material		Ag	Ag/Sn (tarnish protection)	Ag	Ag (alternatively Au)
Temperature data					
Ambient temperature range	°C	-40 ... 125	-40 ... 125	-40 ... 125	-40 ... 125
General data					
Connection method		Screw connection	Push-in connection	QUICKON connection	Crimp connection
Stripping length	mm	8	8 ... 10	-	7.5
No. of pos.		6	6	6	6
Contact numbering		1 - 6	1 - 6	1 - 6	1 - 6
Insertion/withdrawal cycles		≥ 500	≥ 500	≥ 500	≥ 500

Derating curves

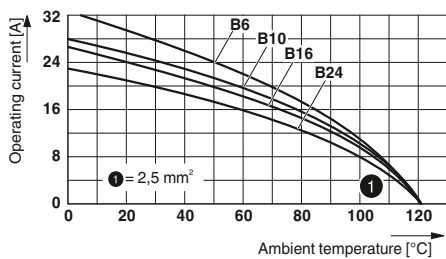

HC-B 6-I-UT...

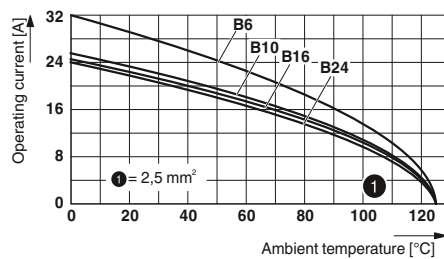

HC-B 6-E...Q-2,5

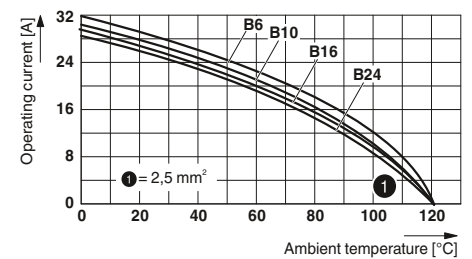

HC-B 6-I-CT...

				Ordering data			Dimensions (in mm)																																																	
Description	Pos.	Number	Size	Type	Order No.		Pcs. / Pkt.																																																	
					Socket	Plug																																																		
Screw connection																																																								
	6	1 - 6	B6	① HC-B 6-I-UT...	1648128	1648115	10	<p>Dimensional drawing</p> <p>Panel cutout</p> <table border="1"> <thead> <tr> <th></th> <th>a</th> <th>b</th> <th>c</th> <th>d</th> </tr> </thead> <tbody> <tr> <td>① Socket</td> <td>50.5</td> <td>44</td> <td>34.6</td> <td>36</td> </tr> <tr> <td>① Plug</td> <td></td> <td></td> <td>32</td> <td></td> </tr> <tr> <td>② Socket</td> <td>50.5</td> <td>44</td> <td>37</td> <td>36</td> </tr> <tr> <td>② Plug</td> <td></td> <td></td> <td>34.4</td> <td></td> </tr> <tr> <td>③ Socket</td> <td>51</td> <td>44</td> <td>37</td> <td>36</td> </tr> <tr> <td>③ Plug</td> <td>51.5</td> <td></td> <td>35</td> <td></td> </tr> <tr> <td>④ Socket</td> <td>50.5</td> <td>44</td> <td>34.6</td> <td>36</td> </tr> <tr> <td>④ Plug</td> <td></td> <td></td> <td>32</td> <td></td> </tr> </tbody> </table>					a	b	c	d	① Socket	50.5	44	34.6	36	① Plug			32		② Socket	50.5	44	37	36	② Plug			34.4		③ Socket	51	44	37	36	③ Plug	51.5		35		④ Socket	50.5	44	34.6	36	④ Plug			32	
	a	b	c	d																																																				
① Socket	50.5	44	34.6	36																																																				
① Plug			32																																																					
② Socket	50.5	44	37	36																																																				
② Plug			34.4																																																					
③ Socket	51	44	37	36																																																				
③ Plug	51.5		35																																																					
④ Socket	50.5	44	34.6	36																																																				
④ Plug			32																																																					
Push-in connection																																																								
	6	1 - 6	B6	② HC-B 6-I-PT...	1407727	1407728	1																																																	
Insulation displacement connection																																																								
	6	1 - 6	B6	③ HC-B 6-E...Q-2,5	1605556	1605611	10																																																	
Crimp connection																																																								
	6	1 - 6	B6	④ HC-B 6-I-CT...	1648160	1648157	10																																																	
Turned crimp contacts CK 2,5 Silver-plated																																																								
			Cross section mm ² / AWG																																																					
			0.5 / 20	CK2,5-ED-0,50... AG	1663640	1663572	100																																																	
			0.75 / 18	CK2,5-ED-0,75... AG	1663653	1663585	100																																																	
			0.75 - 1 / 18	CK2,5-ED-1,00... AG	1663666	1663598	100																																																	
			1.5 / 16	CK2,5-ED-1,50... AG	1663679	1663608	100																																																	
			2.5 / 14	CK2,5-ED-2,50... AG	1663682	1663611	100																																																	
			4 / 12	CK2,5-ED-4,00... AG	1663705	1663637	100																																																	
Turned crimp contacts CK 2,5 Gold-plated																																																								
			Cross section mm ² / AWG																																																					
			0.5 / 20	CK2,5-ED-0,50... AU	1674859	1674804	100																																																	
			0.75 - 1 / 18	CK2,5-ED-1,00... AU	1674833	1674781	100																																																	
			1.5 / 16	CK2,5-ED-1,50... AU	1674820	1674778	100																																																	
			2.5 / 14	CK2,5-ED-2,50... AU	1674862	1674817	100																																																	
			4 / 12	CK2,5-ED-4,00... AU	1674846	1674794	100																																																	

Accessories



Crimping tools
From page 636



Coding elements
From page 638



Replacement PE screws
From page 640

Heavy-duty connectors

HEAVYCON B - contact inserts

B10 series

500 V, 16 A

Connection technology:

- Screw connection
- Push-in connection
- Insulation displacement connection
- Crimp connection

To determine the corresponding housing, see cross-reference list on page 482.

Notes:
For accessories, see from page 634
Order crimp contacts separately
Only operate connectors when there is no load/the power is switched off
For assembly instructions, see phoenixcontact.net/products
For connection technologies, see page 4



Technical data					
Type		① HC-B 10-I-UT-...	② HC-B 10-I-PT-...	③ HC-B 10-E...Q-2,5	④ HC-B 10-I-CT-...
Approvals					
IEC data					
Rated current, contacts (at 40°C)	A	16	16	16	16
Surge voltage category		III	III	III	III
Pollution degree		3	3	3	3
Rated voltage (III/3) contacts	V	500	500	400	500
Rated surge voltage, contacts	kV	6	6	6	6
Connection cross section	mm ²	0.5 ... 2.5	0.14 ... 2.5	0.34 ... 2.5	0.5 ... 4
UL data					
Rated voltage	V	600	600	600	600
Rated current	A	13	13	10	13
Connection cross section	AWG	22-14	14	14	22-14
CSA / cUL data					
Rated voltage	V	600	600	600	600
Rated current	A	13	10	10	20
Connection cross section	AWG	22-14	14	16	20-12
Material data					
Contact carrier material		PA	PA	PA	PA
Inflammability class in acc. with UL 94		V0	V0	V0	V0
Contact material		Copper alloy	Copper alloy	Copper alloy	Copper alloy
Contact surface material		Ag	Ag/Sn (tarnish protection)	Ag	Ag (alternatively Au)
Temperature data					
Ambient temperature range	°C	-40 ... 125	-40 ... 125	-40 ... 125	-40 ... 125
General data					
Connection method		Screw connection	Push-in connection	QUICKON connection	Crimp connection
Stripping length	mm	8	8 ... 10	-	7.5
No. of pos.		10	10	10	10
Contact numbering		1 - 10	1 - 10	1 - 10	1 - 10
Insertion/withdrawal cycles		≥ 500	≥ 500	≥ 500	≥ 500

Derating curves

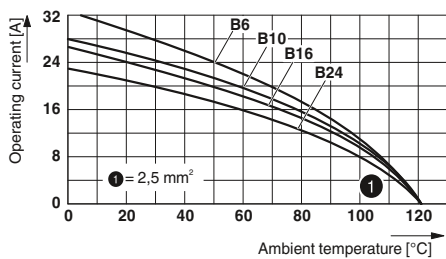

HC-B 10-I-UT-...

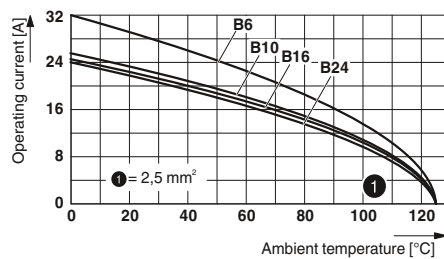

HC-B 10-E...Q-2,5

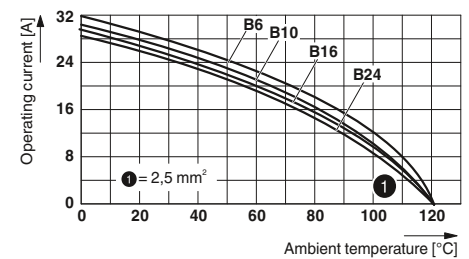

HC-B 10-I-CT-...

				Ordering data																																																				
Description	Pos.	Number	Size	Type	Order No.		Pcs. / Pkt.	Dimensions (in mm)																																																
					Socket	Plug		Dimensional drawing																																																
Screw connection																																																								
	10	1 - 10	B10	① HC-B 10-I-UT-...	1648186	1648173	10																																																	
Push-in connection																																																								
	10	1 - 10	B10	② HC-B 10-I-PT-...	1407729	1407730	1																																																	
Insulation displacement connection																																																								
	10	1 - 10	B10	③ HC-B 10-E...Q-2,5	1605569	1605624	10																																																	
Crimp connection								<table border="1"> <thead> <tr> <th></th> <th>a</th> <th>b</th> <th>c</th> <th>d</th> </tr> </thead> <tbody> <tr> <td>① Socket</td> <td></td> <td></td> <td>34.6</td> <td></td> </tr> <tr> <td>① Plug</td> <td>64</td> <td>57</td> <td>32</td> <td>49</td> </tr> <tr> <td>② Socket</td> <td></td> <td></td> <td>37</td> <td></td> </tr> <tr> <td>② Plug</td> <td>64</td> <td>57</td> <td>34.4</td> <td>49</td> </tr> <tr> <td>③ Socket</td> <td></td> <td></td> <td>37</td> <td></td> </tr> <tr> <td>③ Plug</td> <td>64</td> <td>57</td> <td>35</td> <td>49</td> </tr> <tr> <td>④ Socket</td> <td></td> <td></td> <td>34.6</td> <td></td> </tr> <tr> <td>④ Plug</td> <td>64</td> <td>57</td> <td>32</td> <td>49</td> </tr> </tbody> </table>					a	b	c	d	① Socket			34.6		① Plug	64	57	32	49	② Socket			37		② Plug	64	57	34.4	49	③ Socket			37		③ Plug	64	57	35	49	④ Socket			34.6		④ Plug	64	57	32	49
	a	b	c	d																																																				
① Socket			34.6																																																					
① Plug	64	57	32	49																																																				
② Socket			37																																																					
② Plug	64	57	34.4	49																																																				
③ Socket			37																																																					
③ Plug	64	57	35	49																																																				
④ Socket			34.6																																																					
④ Plug	64	57	32	49																																																				
	10	1 - 10	B10	④ HC-B 10-I-CT-...	1648225	1648212	10																																																	
Turned crimp contacts CK 2,5 Silver-plated				Cross section mm² / AWG																																																				
				0.5 / 20	CK2,5-ED-0,50... AG	1663640	1663572	100																																																
				0.75 / 18	CK2,5-ED-0,75... AG	1663653	1663585	100																																																
				0.75 - 1 / 18	CK2,5-ED-1,00... AG	1663666	1663598	100																																																
				1.5 / 16	CK2,5-ED-1,50... AG	1663679	1663608	100																																																
				2.5 / 14	CK2,5-ED-2,50... AG	1663682	1663611	100																																																
				4 / 12	CK2,5-ED-4,00... AG	1663705	1663637	100																																																
Turned crimp contacts CK 2,5 Gold-plated				Cross section mm² / AWG																																																				
				0.5 / 20	CK2,5-ED-0,50... AU	1674859	1674804	100																																																
				0.75 - 1 / 18	CK2,5-ED-1,00... AU	1674833	1674781	100																																																
				1.5 / 16	CK2,5-ED-1,50... AU	1674820	1674778	100																																																
				2.5 / 14	CK2,5-ED-2,50... AU	1674862	1674817	100																																																
				4 / 12	CK2,5-ED-4,00... AU	1674846	1674794	100																																																

Accessories



Crimping tools
From page 636



Coding elements
From page 638



Replacement PE screws
From page 640

Heavy-duty connectors

HEAVYCON B - contact inserts

B16 series

500 V, 16 A

Connection technology:

- Screw connection
- Push-in connection
- Insulation displacement connection
- Crimp connection

To determine the corresponding housing, see cross-reference list on page 482.

Notes:
For accessories, see from page 634
Order crimp contacts separately
Only operate connectors when there is no load/the power is switched off
For assembly instructions, see phoenixcontact.net/products
For connection technologies, see page 4



Technical data					
Type		①② HC-B 16-I-UT-...	③④ HC-B 16-I-PT-...	⑤⑥ HC-B 16-E...Q-2,5	⑦⑧ HC-B 16-I-CT-...
Approvals		UL, VDE, ENEC	UL, VDE, ENEC	UL, VDE, ENEC	UL, VDE, ENEC
IEC data					
Rated current, contacts (at 40°C)	A	16	16	16	16
Surge voltage category		III	III	III	III
Pollution degree		3	3	3	3
Rated voltage (III/3) contacts	V	500	500	400	500
Rated surge voltage, contacts	kV	6	6	6	6
Connection cross section	mm ²	0.5 ... 2.5	0.14 ... 2.5	0.34 ... 2.5	0.5 ... 4
UL data					
Rated voltage	V	600	600	600	600
Rated current	A	13	13	10	13
Connection cross section	AWG	22-14	14	14	22-14
CSA / cUL data					
Rated voltage	V	600	600	600	600
Rated current	A	13	10	10	20
Connection cross section	AWG	22-14	14	16	20-12
Material data					
Contact carrier material		PA	PA	PA	PA
Inflammability class in acc. with UL 94		V0	V0	V0	V0
Contact material		Copper alloy	Copper alloy	Copper alloy	Copper alloy
Contact surface material		Ag	Ag/Sn (tarnish protection)	Ag	Ag (alternatively Au)
Temperature data					
Ambient temperature range	°C	-40 ... 125	-40 ... 125	-40 ... 125	-40 ... 125
General data					
Connection method		Screw connection	Push-in connection	QUICKON connection	Crimp connection
Stripping length	mm	8	8 ... 10	-	7.5
No. of pos.		16	16	16	16
Contact numbering		1 - 16	1 - 16	1 - 16	1 - 16
Insertion/withdrawal cycles		≥ 500	≥ 500	≥ 500	≥ 500

Derating curves

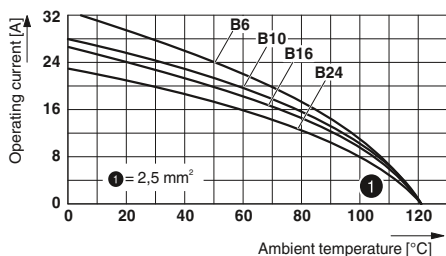



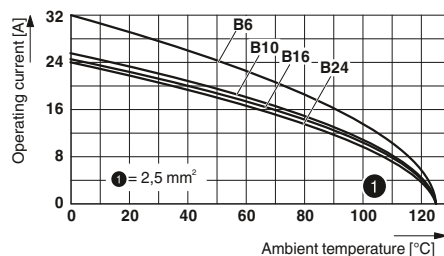

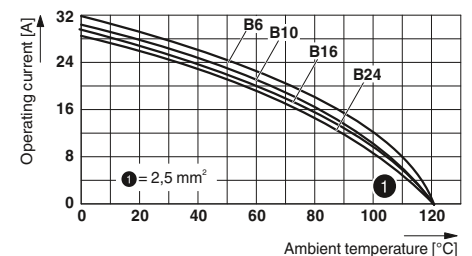

HC-B 16-I-UT-...



HC-B 16-E...Q-2,5



HC-B 16-I-CT-...

Description	Pos.	Number	Size	Type	Order No.		Pcs. / Pkt.
					Socket	Plug	
Screw connection							
	16	1 - 16	B16 / B32	① HC-B 16-I-UT-...	1648241	1648238	10
	16	17 - 32	B16 / B32	② HC-B 16-I-UT-...-32	1584884	1584871	10
Push-in connection							
	16	1 - 16	B16 / B32	③ HC-B 16-I-PT-...	1407731	1407732	1
	16	17 - 32	B16 / B32	④ HC-B 16-I-PT-...-32	1407733	1407734	1
Insulation displacement connection							
	16	1 - 16	B16 / B32	⑤ HC-B 16-E...Q-2,5	1605572	1605637	10
	16	17 - 32	B16 / B32	⑥ HC-B 16-E...Q-2,5-32	1605598	1605653	10
Crimp connection							
	16	1 - 16	B16 / B32	⑦ HC-B 16-I-CT-...	1648283	1648270	10
	16	17 - 32	B16 / B32	⑧ HC-B 16-I-CT-...-32	1584923	1584910	10
Turned crimp contacts CK 2,5 Silver-plated			Cross section mm ² / AWG				
			0.5 / 20	CK2,5-ED-0,50... AG	1663640	1663572	100
			0.75 / 18	CK2,5-ED-0,75... AG	1663653	1663585	100
			0.75 - 1 / 18	CK2,5-ED-1,00... AG	1663666	1663598	100
			1.5 / 16	CK2,5-ED-1,50... AG	1663679	1663608	100
			2.5 / 14	CK2,5-ED-2,50... AG	1663682	1663611	100
			4 / 12	CK2,5-ED-4,00... AG	1663705	1663637	100
Turned crimp contacts CK 2,5 Gold-plated			Cross section mm ² / AWG				
			0.5 / 20	CK2,5-ED-0,50... AU	1674859	1674804	100
			0.75 - 1 / 18	CK2,5-ED-1,00... AU	1674833	1674781	100
			1.5 / 16	CK2,5-ED-1,50... AU	1674820	1674778	100
			2.5 / 14	CK2,5-ED-2,50... AU	1674862	1674817	100
			4 / 12	CK2,5-ED-4,00... AU	1674846	1674794	100

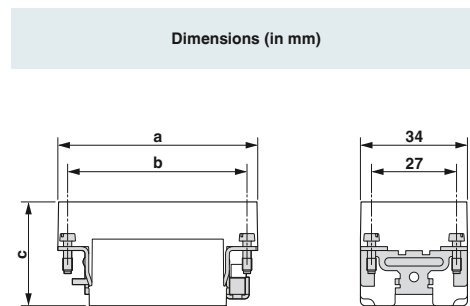

Dimensional drawing

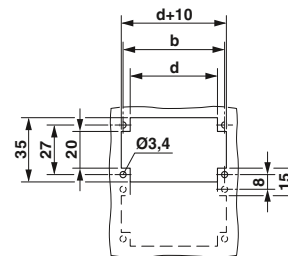

Panel cutout

	a	b	c	d
① Socket	84	77.5	34.6	72
			32	
② Socket	84	77.5	34.6	72
			32	
③ Socket	84	77.5	37	72
			34.4	
④ Socket	84	77.5	37	72
			34.4	
⑤ Socket	84.5	77.5	37	72
			35	
⑥ Socket	84.5	77.5	37	72
			35	
⑦ Socket	84	77.5	34.6	72
			32	
⑧ Socket	84	77.5	34.6	72
			32	

Accessories



Crimping tools
From page 636



Coding elements
From page 638



Replacement PE screws
From page 640

Heavy-duty connectors

HEAVYCON B - contact inserts

B24 series

500 V, 16 A

Connection technology:

- Screw connection
- Push-in connection
- Insulation displacement connection
- Crimp connection

To determine the corresponding housing, see cross-reference list on page 482.

Notes:
For accessories, see from page 634
Order crimp contacts separately
Only operate connectors when there is no load/the power is switched off
For assembly instructions, see phoenixcontact.net/products
For connection technologies, see page 4



Technical data

Type	① ② HC-B 24-I-UT-...	③ ④ HC-B 24-I-PT-...	⑤ ⑥ HC-B 24-E...Q-2,5	⑦ ⑧ HC-B 24-I-CT-...
Approvals	UL, VDE, ENEC	UL, VDE, ENEC	UL, VDE, ENEC	UL, VDE, ENEC
IEC data				
Rated current, contacts (at 40°C)	A	16	16	16
Surge voltage category	III	III	III	III
Pollution degree	3	3	3	3
Rated voltage (III/3) contacts	V	500	500	500
Rated surge voltage, contacts	kV	6	6	6
Connection cross section	mm ²	0.5 ... 2.5	0.14 ... 2.5	0.34 ... 2.5
UL data				
Rated voltage	V	600	600	600
Rated current	A	13	13	10
Connection cross section	AWG	22-14	14	14
CSA / cUL data				
Rated voltage	V	600	600	600
Rated current	A	13	10	10
Connection cross section	AWG	22-14	14	16
Material data				
Contact carrier material	PA	PA	PA	PA
Inflammability class in acc. with UL 94	V0	V0	V0	V0
Contact material	Copper alloy	Copper alloy	Copper alloy	Copper alloy
Contact surface material	Ag	Ag/Sn (tarnish protection)	Ag	Ag (alternatively Au)
Temperature data				
Ambient temperature range	°C	-40 ... 125	-40 ... 125	-40 ... 125
General data				
Connection method	Screw connection	Push-in connection	QUICKON connection	Crimp connection
Stripping length	mm	8	8 ... 10	-
No. of pos.		24	24	24
Contact numbering		1 - 24	1 - 24	1 - 24
Insertion/withdrawal cycles		≥ 500	≥ 500	≥ 500

Derating curves

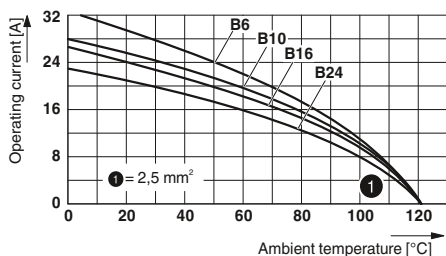

HC-B 24-I-UT-...

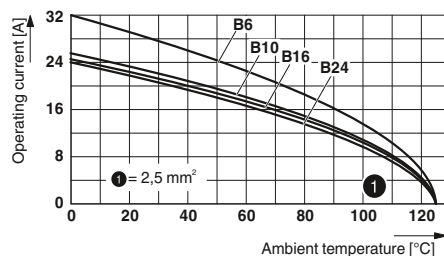

HC-B 24-E...Q-2,5

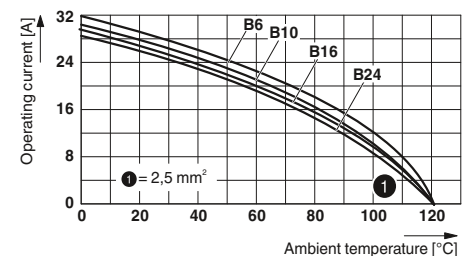

HC-B 24-I-CT-...

				Ordering data			Dimensions (in mm)							
Description	Pos.	Number	Size	Type	Order No.		Pcs. / Pkt.							
					Socket	Plug								
Screw connection														
	24	1 - 24	B24 / B48	① HC-B 24-I-UT-...	1648306	1648296	10							
	24	25 - 48	B24 / B48	② HC-B 24-I-UT-...-48	1584949	1584936	10							
Push-in connection														
	24	1 - 24	B24 / B48	③ HC-B 24-I-PT-...	1407735	1407736	1							
	24	25 - 48	B24 / B48	④ HC-B 24-I-PT-...-48	1407737	1407738	1							
Insulation displacement connection														
	24	1 - 24	B24 / B48	⑤ HC-B 24-E...Q-2,5	1605585	1605640	10							
	24	1 - 24	B24 / B48	⑥ HC-B 24-E...Q-2,5-48	1605608	1605666	10							
Crimp connection														
	24	1 - 24	B24 / B48	⑦ HC-B 24-I-CT-...	1648348	1648335	10							
	24	25 - 48	B24 / B48	⑧ HC-B 24-I-CT-...-48	1584981	1584978	10							
Turned crimp contacts CK 2,5 Silver-plated														
			Cross section mm ² / AWG	CK2,5-ED-0,50... AG	1663640	1663572	100							
			0.5 / 20	CK2,5-ED-0,75... AG	1663653	1663585	100							
			0.75 - 1 / 18	CK2,5-ED-1,00... AG	1663666	1663598	100							
			1.5 / 16	CK2,5-ED-1,50... AG	1663679	1663608	100							
			2.5 / 14	CK2,5-ED-2,50... AG	1663682	1663611	100							
			4 / 12	CK2,5-ED-4,00... AG	1663705	1663637	100							
Turned crimp contacts CK 2,5 Gold-plated														
			Cross section mm ² / AWG	CK2,5-ED-0,50... AU	1674859	1674804	100							
			0.5 / 20	CK2,5-ED-1,00... AU	1674833	1674781	100							
			0.75 - 1 / 18	CK2,5-ED-1,50... AU	1674820	1674778	100							
			1.5 / 16	CK2,5-ED-2,50... AU	1674862	1674817	100							
			2.5 / 14	CK2,5-ED-4,00... AU	1674846	1674794	100							
			4 / 12											

	a	b	c	d
① Socket	111	104	34.6	98
① Plug			32	
② Socket	111	104	34.6	98
② Plug			32	
③ Socket	111	104	37	98
③ Plug			34.4	
④ Socket	111	104	37	98
④ Plug			34.4	
⑤ Socket	111	104	37	98
⑤ Plug			35	
⑥ Socket	111	104	37	98
⑥ Plug			35	
⑦ Socket	111	104	34.6	98
⑦ Plug			32	
⑧ Socket	111	104	34.6	98
⑧ Plug			32	

Accessories



Crimping tools
From page 636



Coding elements
From page 638



Replacement PE screws
From page 640

Heavy-duty connectors

HEAVYCON B - contact inserts

B6, B10, B16, B24 series UT... terminal adapters

500 V, 16 A

Connection technology:
– Screw connection

Notes:
For accessories, see from page 634
Only operate connectors when there is no load/the power is switched off
For assembly instructions, see phoenixcontact.net/products
For connection technologies, see page 4







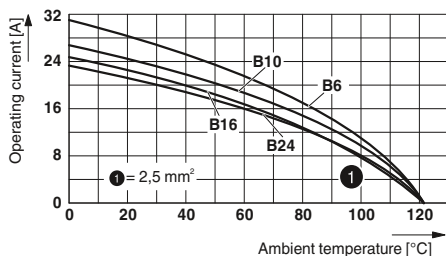

Type	Technical data			
	① ② HC-B 6-A-UT-PEL-...	③ ④ HC-B 10-A-UT-PEL-...	⑤ ⑥ HC-B 16-A-UT-PEL-...	⑦ ⑧ HC-B 24-A-UT-PEL-...
Approvals	PE left UL, VDE, ENEC	PE left UL, VDE, ENEC	PE left UL, VDE, ENEC	PE left UL, VDE, ENEC
IEC data				
Rated current, contacts (at 40°C)	A	16	16	16
Surge voltage category	III	III	III	III
Pollution degree	3	3	3	3
Rated voltage (III/3) contacts	V	500	500	500
Rated surge voltage, contacts	kV	6	6	6
Connection cross section	mm ²	0.5 ... 2.5	0.5 ... 2.5	0.5 ... 2.5
UL data				
Rated voltage	V	600	600	600
Rated current	A	13	13	13
Connection cross section	AWG	22-14	22-14	22-14
CSA / cUL data				
Rated voltage	V	600	600	600
Rated current	A	13	13	13
Connection cross section	AWG	22-14	22-14	22-14
Material data				
Contact carrier material	PA	PA	PA	PA
Inflammability class in acc. with UL 94	V0	V0	V0	V0
Contact material	Copper alloy	Copper alloy	Copper alloy	Copper alloy
Contact surface material	Ag	Ag	Ag	Ag
Temperature data				
Ambient temperature range	°C	-40 ... 125	-40 ... 125	-40 ... 125
General data				
Connection method	Screw connection	Screw connection	Screw connection	Screw connection
Stripping length	mm	12	12	12
No. of pos.		6	10	24
Contact numbering		1 - 6	1 - 10	1 - 24
Insertion/withdrawal cycles		≥ 500	≥ 500	≥ 500

Derating curves



HC-B ...-A-UT-...

Description	Pos.	Number	Size	Type	Ordering data		Pcs. / Pkt.
					Socket	Plug	
Screw connection 	6	1 - 6	B6	PE left ① HC-B 6-A-UT-PEL-...	1648018	1648024	5
	6	1 - 6	B6	PE right ② HC-B 6-A-UT-PER-...	1648066	1648072	5
Screw connection 	10	1 - 10	B10	PE left ③ HC-B 10-A-UT-PEL-...	1648030	1648036	5
	10	1 - 10	B10	PE right ④ HC-B 10-A-UT-PER-...	1648078	1648084	5
Screw connection 	16	1 - 16	B16	PE left ⑤ HC-B 16-A-UT-PEL-...	1648042	1648048	5
	16	1 - 16	B16	PE right ⑥ HC-B 16-A-UT-PER-...	1648090	1648096	5
Screw connection 	24	1 - 24	B24	PE left ⑦ HC-B 24-A-UT-PEL-...	1648054	1648060	5
	24	1 - 24	B24	PE right ⑧ HC-B 24-A-UT-PER-...	1648102	1648108	5
Foot element 				HC-KA-FE	1775240		10
Locking screw barrel 				HC-VSH	1660083		10

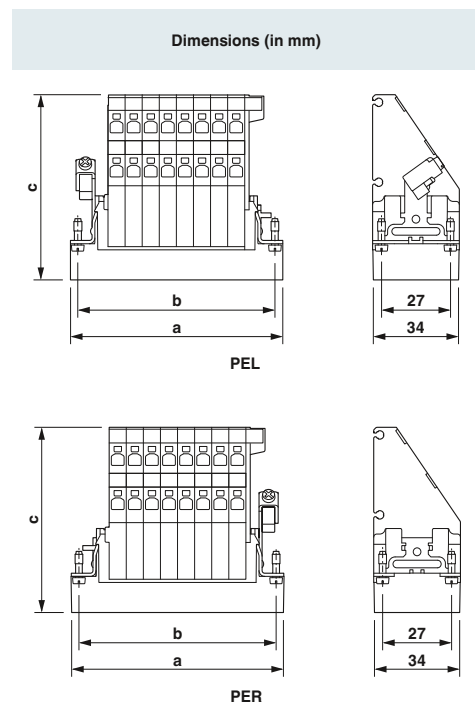

	a	b	c	d
① Socket	51	44	74.2	
① Plug	51	44	71.6	
② Socket	51	44	74.2	
② Plug	51	44	71.6	
③ Socket	64	57	74.2	
③ Plug	64	57	71.6	
④ Socket	64	57	74.2	
④ Plug	64	57	71.6	
⑤ Socket	84.5	77.5	74.2	
⑤ Plug	84.5	77.5	71.6	
⑥ Socket	84.5	77.5	74.2	
⑥ Plug	84.5	77.5	71.6	
⑦ Socket	111	104	74.2	
⑦ Plug	111	104	71.6	
⑧ Socket	111	104	74.2	
⑧ Plug	111	104	71.6	

Accessories



Coding elements
From page 638

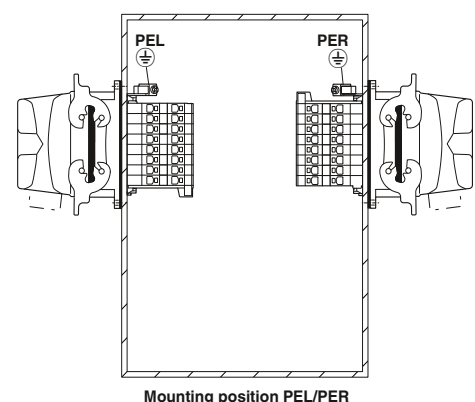

Heavy-duty connectors

HEAVYCON B - contact inserts

B6, B10, B16, B24 series DT terminal adapters

500 V, 16 A

Connection technology:
– Push-in connection

Notes:
For accessories, see from page 634
Only operate connectors when there is no load/the power is switched off
For assembly instructions, see phoenixcontact.net/products
For connection technologies, see page 4







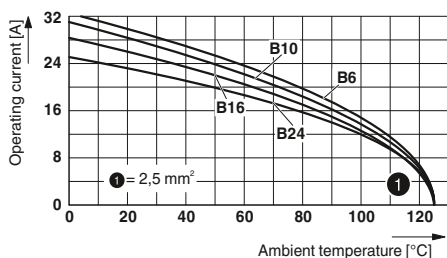

Type	Technical data			
	① ② HC-B 6-A-DT-PEL-...	③ ④ HC-B 10-A-DT-PEL-...	⑤ ⑥ HC-B 16-A-DT-PEL-...	⑦ ⑧ HC-B 24-A-DT-PEL-...
Approvals	PE left UL, VDE, ENEC	PE left UL, VDE, ENEC	PE left UL, VDE, ENEC	PE left UL, VDE, ENEC
IEC data				
Rated current, contacts (at 40°C)	A	16	16	16
Surge voltage category		III	III	III
Pollution degree		3	3	3
Rated voltage (III/3) contacts	V	500	500	500
Rated surge voltage, contacts	kV	6	6	6
Connection cross section	mm ²	0.5 ... 2.5	0.5 ... 2.5	0.5 ... 2.5
UL data				
Rated voltage	V	600	600	600
Rated current	A	13	13	13
Connection cross section	AWG	22-14	22-14	22-14
CSA / cUL data				
Rated voltage	V	600	600	600
Rated current	A	13	13	13
Connection cross section	AWG	22-14	22-14	22-14
Material data				
Contact carrier material		PA	PA	PA
Inflammability class in acc. with UL 94		V0	V0	V0
Contact material		Copper alloy	Copper alloy	Copper alloy
Contact surface material		Ag	Ag	Ag
Temperature data				
Ambient temperature range	°C	-40 ... 125	-40 ... 125	-40 ... 125
General data				
Connection method		Push-in connection	Push-in connection	Push-in connection
Stripping length	mm	10	10	10
No. of pos.		6	10	16
Contact numbering		1 - 6	1 - 10	1 - 16
Insertion/withdrawal cycles		≥ 500	≥ 500	≥ 500

Derating curves



HC-B ...-A-DT-PER-...

Description	Pos.	Number	Size	Type	Ordering data		Pcs. / Pkt.
					Socket	Plug	
Push-in connection 	6	1 - 6	B6	PE left ① HC-B 6-A-DT-PEL-...	1648351	1648364	5
	6	1 - 6	B6	PE right ② HC-B 6-A-DT-PER-...	1648377	1648380	5
Push-in connection 	10	1 - 10	B10	PE left ③ HC-B 10-A-DT-PEL-...	1648393	1648403	5
	10	1 - 10	B10	PE right ④ HC-B 10-A-DT-PER-...	1648416	1648429	5
Push-in connection 	16	1 - 16	B16	PE left ⑤ HC-B 16-A-DT-PEL-...	1648432	1648445	5
	16	1 - 16	B16	PE right ⑥ HC-B 16-A-DT-PER-...	1648458	1648461	5
Push-in connection 	24	1 - 24	B24	PE left ⑦ HC-B 24-A-DT-PEL-...	1648474	1648487	5
	24	1 - 24	B24	PE right ⑧ HC-B 24-A-DT-PER-...	1648490	1648500	5
Foot element 				HC-KA-FE	1775240		10
Locking screw barrel 				HC-VSH	1660083		10

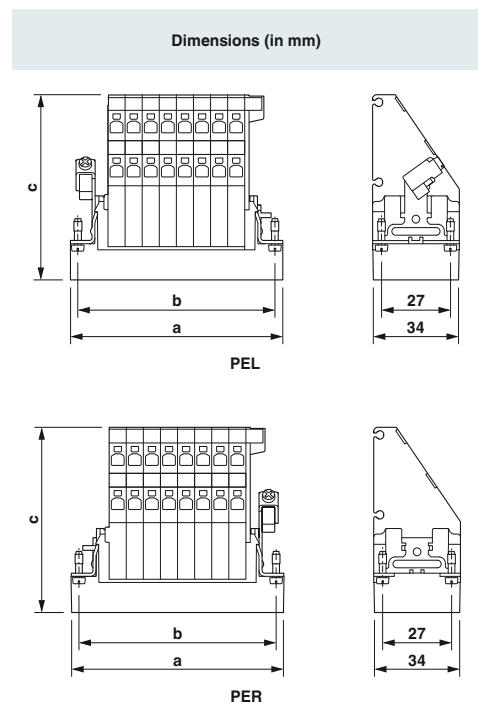

	a	b	c	d
① Socket			72.1	
① Plug	50.5	44	70.5	
② Socket			72.1	
② Plug	50.5	44	70.5	
③ Socket			72.1	
③ Plug	64	57	70.5	
④ Socket			72.1	
④ Plug	64	57	70.5	
⑤ Socket			72.1	
⑤ Plug	84	77.5	70.5	
⑥ Socket			72.1	
⑥ Plug	84	77.5	70.5	
⑦ Socket			72.1	
⑦ Plug	111	104	70.5	
⑧ Socket			72.1	
⑧ Plug	111	104	70.5	

Accessories



Coding elements
From page 638

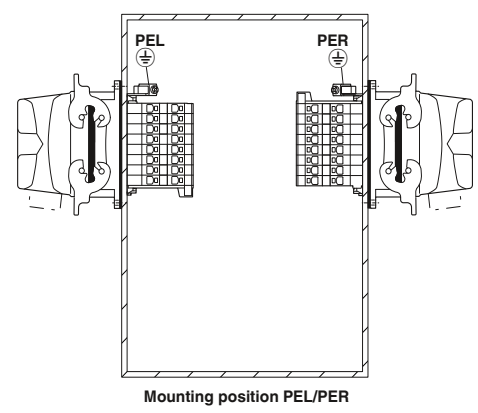

Heavy-duty connectors

HEAVYCON B - contact inserts

BB10, BB18, BB32, BB46 series

500 V, 16 A

Connection technology:

– Crimp connection

To determine the corresponding housing, see cross-reference list on page 482.

Notes:
For accessories, see from page 634
Order crimp contacts separately
Only operate connectors when there is no load/the power is switched off
For assembly instructions, see phoenixcontact.net/products
For connection technologies, see page 4

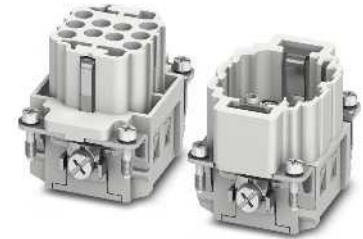







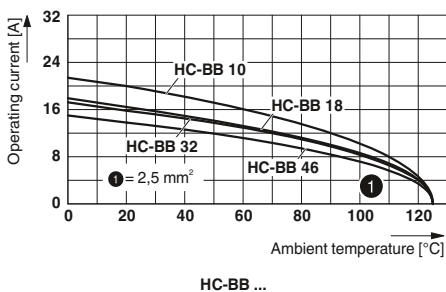

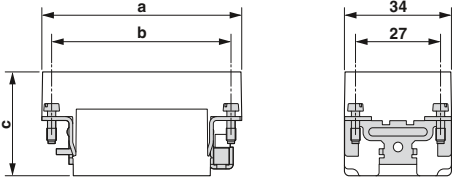
Technical data

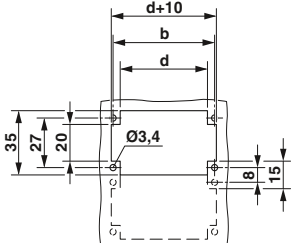
Type	① HC-BB 10-I-CT-...	② HC-BB 18-I-CT-...	③ ④ HC-BB 32-I-CT-...	⑤ ⑥ HC-BB 46-I-CT-...
Approvals	ERC	ERC	ERC	ERC
IEC data				
Rated current, contacts (at 40°C)	A	16	16	16
Surge voltage category	III	III	III	III
Pollution degree	3	3	3	3
Rated voltage (III/3) contacts	V	500	500	500
Rated surge voltage, contacts	kV	6	6	6
Connection cross section	mm ²	0.5 ... 4	0.5 ... 4	0.5 ... 4
UL data				
Rated voltage	V	600	600	600
Rated current	A	20	20	16
Connection cross section	AWG	12	12	12
CSA / cUL data				
Rated voltage	V	-	-	-
Rated current	A	-	-	-
Connection cross section	AWG	-	-	-
Material data				
Contact carrier material	PC	PC	PC	PC
Inflammability class in acc. with UL 94	V0	V0	V0	V0
Contact material	Copper alloy	Copper alloy	Copper alloy	Copper alloy
Contact surface material	Ag (alternatively Au)	Ag (alternatively Au)	Ag (alternatively Au)	Ag (alternatively Au)
Temperature data				
Ambient temperature range	°C	-40 ... 125	-40 ... 125	-40 ... 125
General data				
Connection method	Crimp connection	Crimp connection	Crimp connection	Crimp connection
Stripping length	mm	7.5	7.5	7.5
No. of pos.		10	18	32
Contact numbering		1 - 10	1 - 18	1 - 32
Insertion/withdrawal cycles		≥ 500	≥ 500	≥ 500

Derating curves



				Ordering data			Dimensions (in mm)																																																																					
Description	Pos.	Number	Size	Type	Order No.		Pcs. / Pkt.	Dimensions (in mm)																																																																				
					Socket	Plug																																																																						
Crimp connection																																																																												
	10	1 - 10	B6	① HC-BB 10-I-CT-...	1584703	1584774	1																																																																					
Crimp connection								 <p style="text-align: center;">Dimensional drawing</p> <p style="text-align: center;">Panel cutout</p>																																																																				
	18	1 - 18	B10	② HC-BB 18-I-CT-...	1584729	1584716	1																																																																					
Crimp connection																																																																												
	32	1 - 32	B16 / B32	③ HC-BB 32-I-CT-...	1584745	1584732	1																																																																					
	32	33 - 64	B16 / B32	④ HC-BB 32-I-CT-... 33-64	1406543	1406544	1																																																																					
Crimp connection								<table border="1"> <thead> <tr> <th></th> <th>a</th> <th>b</th> <th>c</th> <th>d</th> </tr> </thead> <tbody> <tr> <td>① Socket</td> <td>51</td> <td>44</td> <td>32.5</td> <td></td> </tr> <tr> <td>① Plug</td> <td></td> <td></td> <td>33.2</td> <td>35</td> </tr> <tr> <td>② Socket</td> <td>64</td> <td>57</td> <td>32.5</td> <td>48</td> </tr> <tr> <td>② Plug</td> <td></td> <td></td> <td>33.2</td> <td></td> </tr> <tr> <td>③ Socket</td> <td>84.5</td> <td>77.5</td> <td>32.5</td> <td>68.5</td> </tr> <tr> <td>③ Plug</td> <td></td> <td></td> <td>33.2</td> <td></td> </tr> <tr> <td>④ Socket</td> <td>84.5</td> <td>77.5</td> <td>32.5</td> <td>68.5</td> </tr> <tr> <td>④ Plug</td> <td></td> <td></td> <td>33.2</td> <td></td> </tr> <tr> <td>⑤ Socket</td> <td>111</td> <td>104</td> <td>32.5</td> <td>95</td> </tr> <tr> <td>⑤ Plug</td> <td></td> <td></td> <td>33.2</td> <td></td> </tr> <tr> <td>⑥ Socket</td> <td>111</td> <td>104</td> <td>32.5</td> <td>95</td> </tr> <tr> <td>⑥ Plug</td> <td></td> <td></td> <td>33.2</td> <td></td> </tr> </tbody> </table>					a	b	c	d	① Socket	51	44	32.5		① Plug			33.2	35	② Socket	64	57	32.5	48	② Plug			33.2		③ Socket	84.5	77.5	32.5	68.5	③ Plug			33.2		④ Socket	84.5	77.5	32.5	68.5	④ Plug			33.2		⑤ Socket	111	104	32.5	95	⑤ Plug			33.2		⑥ Socket	111	104	32.5	95	⑥ Plug			33.2	
	a	b	c	d																																																																								
① Socket	51	44	32.5																																																																									
① Plug			33.2	35																																																																								
② Socket	64	57	32.5	48																																																																								
② Plug			33.2																																																																									
③ Socket	84.5	77.5	32.5	68.5																																																																								
③ Plug			33.2																																																																									
④ Socket	84.5	77.5	32.5	68.5																																																																								
④ Plug			33.2																																																																									
⑤ Socket	111	104	32.5	95																																																																								
⑤ Plug			33.2																																																																									
⑥ Socket	111	104	32.5	95																																																																								
⑥ Plug			33.2																																																																									
	46	1 - 46	B24 / B48	⑤ HC-BB 46-I-CT-...	1584758	1584761	1																																																																					
	46	47 - 92	B24 / B48	⑥ HC-BB 46-I-CT-... 47-92	1406545	1406546	1																																																																					
Turned crimp contacts CK 2,5 Silver-plated			Cross section mm ² / AWG																																																																									
			0.5 / 20	CK2,5-ED-0,50... AG	1663640	1663572	100																																																																					
			0.75 / 18	CK2,5-ED-0,75... AG	1663653	1663585	100																																																																					
			0.75 - 1 / 18	CK2,5-ED-1,00... AG	1663666	1663598	100																																																																					
			1.5 / 16	CK2,5-ED-1,50... AG	1663679	1663608	100																																																																					
			2.5 / 14	CK2,5-ED-2,50... AG	1663682	1663611	100																																																																					
			4 / 12	CK2,5-ED-4,00... AG	1663705	1663637	100																																																																					
Turned crimp contacts CK 2,5 Gold-plated			Cross section mm ² / AWG																																																																									
			0.5 / 20	CK2,5-ED-0,50... AU	1674859	1674804	100																																																																					
			0.75 - 1 / 18	CK2,5-ED-1,00... AU	1674833	1674781	100																																																																					
			1.5 / 16	CK2,5-ED-1,50... AU	1674820	1674778	100																																																																					
			2.5 / 14	CK2,5-ED-2,50... AU	1674862	1674817	100																																																																					
			4 / 12	CK2,5-ED-4,00... AU	1674846	1674794	100																																																																					

Accessories



Crimping tools
From page 636



Coding profiles
From page 638



Replacement PE screws
From page 640

Heavy-duty connectors

HEAVYCON B - contact inserts

BBB40, BBB64 series

500 V, 16 A

Connection technology:

– Crimp connection

To determine the corresponding housing, see cross-reference list on page 482.

Notes:
For accessories, see from page 634
Order crimp contacts separately
Only operate connectors when there is no load/the power is switched off
For assembly instructions, see phoenixcontact.net/products
For connection technologies, see page 4





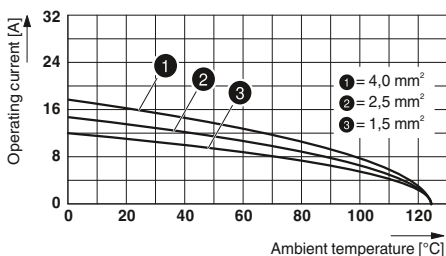

Type	Technical data		
	① HC-BBB 40-E...C	② HC-BBB 64-E...C	
Approvals			
IEC data			
Rated current, contacts (at 40°C)	A	16	16
Surge voltage category		III	III
Pollution degree		3	3
Rated voltage (III/3) contacts	V	500	500
Rated surge voltage, contacts	kV	6	6
Connection cross section	mm ²	0.5 ... 4	0.5 ... 4
UL data			
Rated voltage	V	500	500
Rated current	A	-	-
Connection cross section	AWG	12	12
CSA / cUL data			
Rated voltage	V	500	500
Rated current	A	-	-
Connection cross section	AWG	12	12
Material data			
Contact carrier material		PC	PC
Inflammability class in acc. with UL 94		V0	V0
Contact material		Copper alloy	Copper alloy
Contact surface material		Ag (alternatively Au)	Ag (alternatively Au)
Temperature data			
Ambient temperature range	°C	-40 ... 125	-40 ... 125
General data			
Connection method		Crimp connection	Crimp connection
Stripping length	mm	7.5	7.5
No. of pos.		40	64
Contact numbering		1 - 40	1 - 64
Insertion/withdrawal cycles		≥ 500	≥ 500

Derating curves

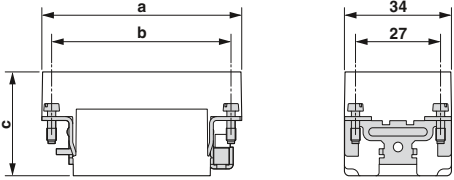

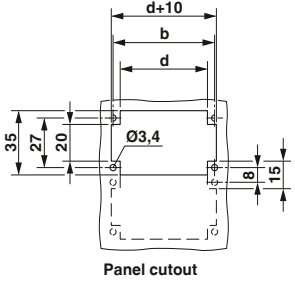
HC-BBB ...

Description	Pos.	Number	Size	Ordering data			Pcs. / Pkt.	Dimensions (in mm)																									
				Type	Order No. Socket	Order No. Plug																											
Crimp connection 	40	1 - 40	B16 / B32	① HC-BBB 40-E...C	1409930	1409921	1																										
Crimp connection 	64	1 - 64	B24 / B48	② HC-BBB 64-E...C	1409914	1409901	1	 <p style="text-align: center;">Panel cutout</p>																									
								<table border="1"> <thead> <tr> <th></th> <th>a</th> <th>b</th> <th>c</th> <th>d</th> </tr> </thead> <tbody> <tr> <td>① Socket</td> <td>84</td> <td>77.5</td> <td>37</td> <td>68.5</td> </tr> <tr> <td>① Plug</td> <td>84.5</td> <td>77.5</td> <td>34.4</td> <td>68.5</td> </tr> <tr> <td>② Socket</td> <td>111</td> <td>104</td> <td>39</td> <td>95</td> </tr> <tr> <td>② Plug</td> <td>111</td> <td>104</td> <td>36.4</td> <td>95</td> </tr> </tbody> </table>		a	b	c	d	① Socket	84	77.5	37	68.5	① Plug	84.5	77.5	34.4	68.5	② Socket	111	104	39	95	② Plug	111	104	36.4	95
	a	b	c	d																													
① Socket	84	77.5	37	68.5																													
① Plug	84.5	77.5	34.4	68.5																													
② Socket	111	104	39	95																													
② Plug	111	104	36.4	95																													
Turned crimp contacts CK 2,5 Silver-plated			Cross section mm ² / AWG																														
			0.5 / 20	CK2,5-ED-0,50... AG	1663640	1663572	100																										
			0.75 / 18	CK2,5-ED-0,75... AG	1663653	1663585	100																										
			0.75 - 1 / 18	CK2,5-ED-1,00... AG	1663666	1663598	100																										
			1.5 / 16	CK2,5-ED-1,50... AG	1663679	1663608	100																										
			2.5 / 14	CK2,5-ED-2,50... AG	1663682	1663611	100																										
			4 / 12	CK2,5-ED-4,00... AG	1663705	1663637	100																										
Turned crimp contacts CK 2,5 Gold-plated			Cross section mm ² / AWG																														
			0.5 / 20	CK2,5-ED-0,50... AU	1674859	1674804	100																										
			0.75 - 1 / 18	CK2,5-ED-1,00... AU	1674833	1674781	100																										
			1.5 / 16	CK2,5-ED-1,50... AU	1674820	1674778	100																										
			2.5 / 14	CK2,5-ED-2,50... AU	1674862	1674817	100																										
			4 / 12	CK2,5-ED-4,00... AU	1674846	1674794	100																										

Accessories



Crimping tools
From page 636



Coding elements
From page 639



Replacement PE screws
From page 640

Heavy-duty connectors

HEAVYCON B - contact inserts

HV03 series

High-voltage applications

830 V, 16 - 25 A

Connection technology:



- Push-in connection
- Crimp connection





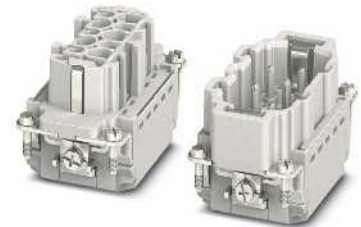

- With 2 lagging switch contacts
- For all size B housing

To determine the corresponding housing, see cross-reference list on page 482.

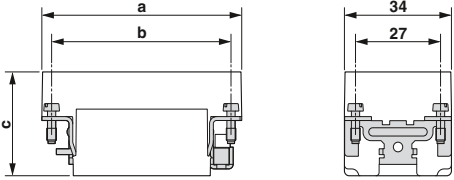
Notes:
For accessories, see from page 634
Order crimp contacts separately
Only operate connectors when there is no load/the power is switched off
For assembly instructions, see phoenixcontact.net/products
For connection technologies, see page 4

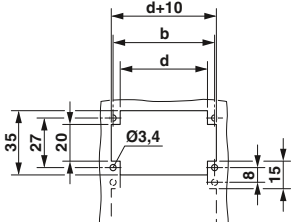

Type	Technical data			
	① HC-HV03-I-PT-...	② HC-HV03-I-CT-...		
Approvals				
IEC data				
Rated current, contacts (at 40°C)	A	16	25	
Surge voltage category		III	III	
Pollution degree		3	3	
Rated voltage (III/3) contacts	V	830	830	
Rated surge voltage, contacts	kV	8	8	
Connection cross section	mm ²	0.14 ... 2.5	0.5 ... 4	
UL data				
Rated voltage	V	800	-	
Rated current	A	13	-	
Connection cross section	AWG	14	-	
CSA / cUL data				
Rated voltage	V	800	-	
Rated current	A	13	-	
Connection cross section	AWG	14	-	
Material data				
Contact carrier material		PA	PA	
Inflammability class in acc. with UL 94		V0	V0	
Contact material		Copper alloy	Copper alloy	
Contact surface material		-	Ag (alternatively Au)	
Temperature data				
Ambient temperature range	°C	-40 ... 125	-40 ... 125	
General data				
Connection method		Push-in connection	Crimp connection	
Stripping length	mm	8 ... 10	7.5	
No. of pos.		3	3	
Contact numbering		-	-	
Insertion/withdrawal cycles		≥ 500	≥ 500	

				Ordering data										
Description	Pos.	Number	Size	Type	Order No.		Pcs. / Pkt.	Dimensions (in mm)						
					Socket	Plug		Dimensional drawing						
Push-in connection 	3 / 2		B10	① HC-HV03-I-PT...	1407743	1407739	1							
Crimp connection 	3 / 2		B10	② HC-HV03-I-CT...	1405261	1405260	1	 Dimensional drawing Panel cutout						
Turned crimp contacts CK 2,5 Silver-plated 			Cross section mm² / AWG											
			0.5 / 20	CK2,5-ED-0,50... AG	1663640	1663572	100							
			0.75 - 1 / 18	CK2,5-ED-0,75... AG	1663653	1663585	100							
			0.75 - 1 / 18	CK2,5-ED-1,00... AG	1663666	1663598	100							
			1.5 / 16	CK2,5-ED-1,50... AG	1663679	1663608	100							
			2.5 / 14	CK2,5-ED-2,50... AG	1663682	1663611	100							
			4 / 12	CK2,5-ED-4,00... AG	1663705	1663637	100							
Turned crimp contacts CK 2,5 Gold-plated 			Cross section mm² / AWG											
			0.5 / 20	CK2,5-ED-0,50... AU	1674859	1674804	100							
			0.75 - 1 / 18	CK2,5-ED-1,00... AU	1674833	1674781	100							
			1.5 / 16	CK2,5-ED-1,50... AU	1674820	1674778	100							
			2.5 / 14	CK2,5-ED-2,50... AU	1674862	1674817	100							
			4 / 12	CK2,5-ED-4,00... AU	1674846	1674794	100							
Turned switch contacts CK 2,5 Pin, silver-plated 			Cross section mm² / AWG											
			1 / 18	CK2,5-ED-1,00ST-S AG		1663857								
			1.5 / 16	CK2,5-ED-1,50ST-S AG		1663860								
			2.5 / 14	CK2,5-ED-2,50ST-S AG		1663873								

	a	b	c	d
① Socket			34.6	
① Plug	64	57	32	49
② Socket	64	57	34.6	
② Plug			32	49

Accessories



Crimping tools
From page 636



Coding elements
From page 639



Replacement PE screws
From page 640

Heavy-duty connectors

HEAVYCON B - contact inserts

HV06 series

High-voltage applications

830 V, 16 - 25 A

Connection technology:



- Push-in connection
- Crimp connection







- With 2 lagging switch contacts
- For all size B housing

To determine the corresponding housing, see cross-reference list on page 482.

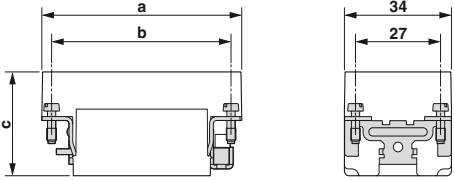
Notes:
For accessories, see from page 634
Order crimp contacts separately
Only operate connectors when there is no load/the power is switched off
For assembly instructions, see phoenixcontact.net/products
For connection technologies, see page 4

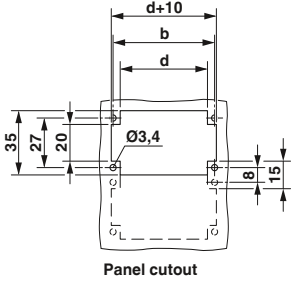

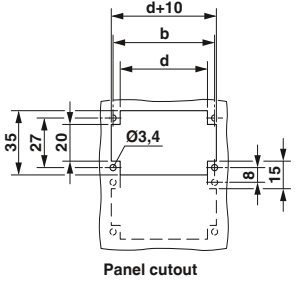
Type	Technical data			
	① HC-HV06-I-PT-...	② HC-HV06-I-CT-...		
Approvals				
IEC data				
Rated current, contacts (at 40°C)	A	16	25	
Surge voltage category		III	III	
Pollution degree		3	3	
Rated voltage (III/3) contacts	V	830	830	
Rated surge voltage, contacts	kV	8	8	
Connection cross section	mm ²	0.14 ... 2.5	0.5 ... 4	
UL data				
Rated voltage	V	800	-	
Rated current	A	13	-	
Connection cross section	AWG	14	-	
CSA / cUL data				
Rated voltage	V	800	-	
Rated current	A	13	-	
Connection cross section	AWG	14	-	
Material data				
Contact carrier material		PA	PA	
Inflammability class in acc. with UL 94		V0	V0	
Contact material		Copper alloy	Copper alloy	
Contact surface material		-	Ag (alternatively Au)	
Temperature data				
Ambient temperature range	°C	-40 ... 125	-40 ... 125	
General data				
Connection method		Push-in connection	Crimp connection	
Stripping length	mm	8 ... 10	7.5	
No. of pos.		6	6	
Contact numbering		-	-	
Insertion/withdrawal cycles		≥ 500	≥ 500	

				Ordering data																																
Description	Pos.	Number	Size	Type	Order No.		Pcs. / Pkt.	Dimensions (in mm)																												
					Socket	Plug		Dimensional drawing																												
Push-in connection 	6 / 2	B16 / B32		① HC-HV06-I-PT...	1407744	1407740	1																													
Crimp connection 	6 / 2	B16 / B32		② HC-HV06-I-CT...	1405263	1405262	1																													
Turned crimp contacts CK 2,5 Silver-plated 			Cross section mm ² / AWG 0.5 / 20 0.75 - 1 / 18 0.75 - 1 / 18 1.5 / 16 2.5 / 14 4 / 12	CK2,5-ED-0,50... AG CK2,5-ED-0,75... AG CK2,5-ED-1,00... AG CK2,5-ED-1,50... AG CK2,5-ED-2,50... AG CK2,5-ED-4,00... AG	1663640 1663653 1663666 1663679 1663682 1663705	1663572 1663585 1663598 1663608 1663611 1663637	100 100 100 100 100 100																													
Turned crimp contacts CK 2,5 Gold-plated 			Cross section mm ² / AWG 0.5 / 20 0.75 - 1 / 18 1.5 / 16 2.5 / 14 4 / 12	CK2,5-ED-0,50... AU CK2,5-ED-1,00... AU CK2,5-ED-1,50... AU CK2,5-ED-2,50... AU CK2,5-ED-4,00... AU	1674859 1674833 1674820 1674862 1674846	1674804 1674781 1674778 1674817 1674794	100 100 100 100 100	<table border="1"> <thead> <tr> <th></th> <th>a</th> <th>b</th> <th>c</th> <th>d</th> </tr> </thead> <tbody> <tr> <td>① Socket</td> <td></td> <td></td> <td>34.6</td> <td></td> </tr> <tr> <td>① Plug</td> <td>84</td> <td>77.5</td> <td>32</td> <td>72</td> </tr> <tr> <td>② Socket</td> <td></td> <td></td> <td>34.6</td> <td></td> </tr> <tr> <td>② Plug</td> <td>84</td> <td>77.5</td> <td>32</td> <td>72</td> </tr> </tbody> </table>					a	b	c	d	① Socket			34.6		① Plug	84	77.5	32	72	② Socket			34.6		② Plug	84	77.5	32	72
	a	b	c	d																																
① Socket			34.6																																	
① Plug	84	77.5	32	72																																
② Socket			34.6																																	
② Plug	84	77.5	32	72																																
Turned switch contacts CK 2,5 Pin, silver-plated 			Cross section mm ² / AWG 1 / 18 1.5 / 16 2.5 / 14	CK2,5-ED-1,00ST-S AG CK2,5-ED-1,50ST-S AG CK2,5-ED-2,50ST-S AG		1663857 1663860 1663873																														

Accessories



Crimping tools
From page 636



Coding elements
From page 639



Replacement PE screws
From page 640

Heavy-duty connectors

HEAVYCON B - contact inserts

HV10 series

High-voltage applications

830 V, 16 - 25 A

Connection technology:



- Push-in connection
- Crimp connection





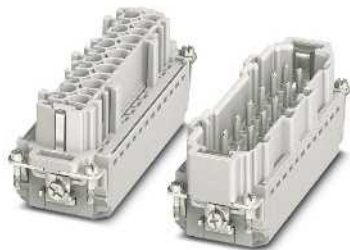

- With 2 lagging switch contacts
- For all size B housing

To determine the corresponding housing, see cross-reference list on page 482.

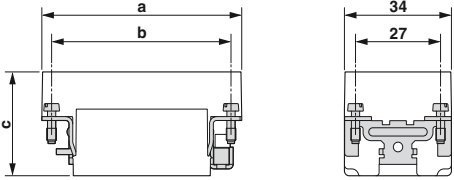
Notes:
For accessories, see from page 634
Order crimp contacts separately
Only operate connectors when there is no load/the power is switched off
For assembly instructions, see phoenixcontact.net/products
For connection technologies, see page 4

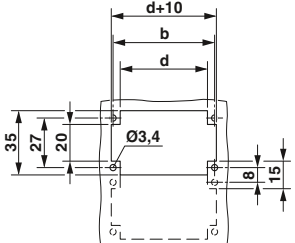

Type	Technical data			
	① HC-HV10-I-PT-...	② HC-HV10-I-CT-...		
Approvals				
IEC data				
Rated current, contacts (at 40°C)	A	16	25	
Surge voltage category		III	III	
Pollution degree		3	3	
Rated voltage (III/3) contacts	V	830	830	
Rated surge voltage, contacts	kV	8	8	
Connection cross section	mm ²	0.14 ... 2.5	0.5 ... 4	
UL data				
Rated voltage	V	800	-	
Rated current	A	13	-	
Connection cross section	AWG	14	-	
CSA / cUL data				
Rated voltage	V	800	-	
Rated current	A	13	-	
Connection cross section	AWG	14	-	
Material data				
Contact carrier material		PA	PA	
Inflammability class in acc. with UL 94		V0	V0	
Contact material		Copper alloy	Copper alloy	
Contact surface material		-	Ag (alternatively Au)	
Temperature data				
Ambient temperature range	°C	-40 ... 125	-40 ... 125	
General data				
Connection method		Push-in connection	Crimp connection	
Stripping length	mm	8 ... 10	7.5	
No. of pos.		10	10	
Contact numbering		-	-	
Insertion/withdrawal cycles		≥ 500	≥ 500	

				Ordering data																																
Description	Pos.	Number	Size	Type	Order No.		Pcs. / Pkt.	Dimensions (in mm)																												
					Socket	Plug		Dimensional drawing																												
Push-in connection 	10 / 2	B24 / B48		① HC-HV10-I-PT...	1407745	1407741	1																													
Crimp connection 	10 / 2	B24 / B48		② HC-HV10-I-CT...	1405265	1405264	1	 <p>Panel cutout</p>																												
Turned crimp contacts CK 2,5 Silver-plated 			Cross section mm ² / AWG 0.5 / 20 0.75 - 1 / 18 0.75 - 1 / 18 1.5 / 16 2.5 / 14 4 / 12	CK2,5-ED-0,50... AG CK2,5-ED-0,75... AG CK2,5-ED-1,00... AG CK2,5-ED-1,50... AG CK2,5-ED-2,50... AG CK2,5-ED-4,00... AG	1663640 1663653 1663666 1663679 1663682 1663705	1663572 1663585 1663598 1663608 1663611 1663637	100 100 100 100 100 100	<table border="1"> <thead> <tr> <th></th> <th>a</th> <th>b</th> <th>c</th> <th>d</th> </tr> </thead> <tbody> <tr> <td>① Socket</td> <td></td> <td></td> <td>34.6</td> <td></td> </tr> <tr> <td>① Plug</td> <td>111</td> <td>104</td> <td>32</td> <td>98</td> </tr> <tr> <td>② Socket</td> <td></td> <td></td> <td>34.6</td> <td></td> </tr> <tr> <td>② Plug</td> <td>111</td> <td>104</td> <td>32</td> <td>98</td> </tr> </tbody> </table>					a	b	c	d	① Socket			34.6		① Plug	111	104	32	98	② Socket			34.6		② Plug	111	104	32	98
	a	b	c	d																																
① Socket			34.6																																	
① Plug	111	104	32	98																																
② Socket			34.6																																	
② Plug	111	104	32	98																																
Turned crimp contacts CK 2,5 Gold-plated 			Cross section mm ² / AWG 0.5 / 20 0.75 - 1 / 18 1.5 / 16 2.5 / 14 4 / 12	CK2,5-ED-0,50... AU CK2,5-ED-1,00... AU CK2,5-ED-1,50... AU CK2,5-ED-2,50... AU CK2,5-ED-4,00... AU	1674859 1674833 1674820 1674862 1674846	1674804 1674781 1674778 1674817 1674794	100 100 100 100 100																													
Turned switch contacts CK 2,5 Pin, silver-plated 			Cross section mm ² / AWG 1 / 18 1.5 / 16 2.5 / 14	CK2,5-ED-1,00ST-S AG CK2,5-ED-1,50ST-S AG CK2,5-ED-2,50ST-S AG		1663857 1663860 1663873																														

Accessories



Crimping tools
From page 636



Coding elements
From page 639



Replacement PE screws
From page 640

Heavy-duty connectors

HEAVYCON B - contact inserts

HS series

High-current applications

400/690 V, 41A
1000 V, 80 A

Connection technology:

– Screw connection

To determine the corresponding housing, see cross-reference list on page 482.

Notes:
For accessories, see from page 634
Only operate connectors when there is no load/the power is switched off
For assembly instructions, see phoenixcontact.net/products
For connection technologies, see page 4
1) For solid conductors and stranded wires with wire end protection



Technical data				
Type		①② HC-HS06-I-UT-...	③ HC-K 6/0-E...S	
Approvals		ERC	ERC	
IEC data				
Rated current, contacts (at 40°C)	A	41	80	
Surge voltage category		III	III	
Pollution degree		3	3	
Rated voltage (III/3) contacts	V	400 / 690	1000	
Rated surge voltage, contacts	kV	6	8	
Connection cross section	mm ²	0.5 ... 6	6 ... 16	
UL data				
Rated voltage	V	600	600	
Rated current	A	35	-	
Connection cross section	AWG	10	10-6	
CSA / cUL data				
Rated voltage	V	-	-	
Rated current	A	-	-	
Connection cross section	AWG	-	-	
Material data				
Contact carrier material		PC	PA	
Inflammability class in acc. with UL 94		V0	V0	
Contact material		Copper alloy	Copper alloy	
Contact surface material		Ag	-	
Temperature data				
Ambient temperature range	°C	-40 ... 125	-40 ... 125	
General data				
Connection method		Screw connection	Screw connection	
Stripping length	mm	10	15	
No. of pos.		6	6	
Contact numbering		1 - 6	1-6	
Insertion/withdrawal cycles		≥ 500	≥ 500	

Derating curves

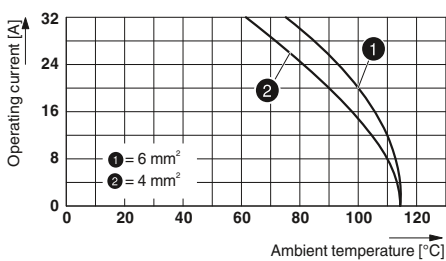

HC-HS06-I-UT-...

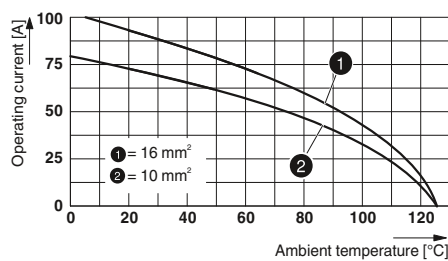

HC-K 6/0-E...S

Description	Pos.	Number	Size	Type	Ordering data		Pcs. / Pkt.
					Socket	Plug	
Screw connection 	6	1 - 6	B16 / B32	① HC-HS06-I-UT...	1406530	1406531	1
	6	7 - 12	B16 / B32	② HC-HS06-I-UT... 7-12	1406533	1406534	1
Screw connection¹⁾ 	6	1 - 6	B16 / B32	③ HC-K 6/0-E...S	1580537	1580538	10

Dimensions (in mm)

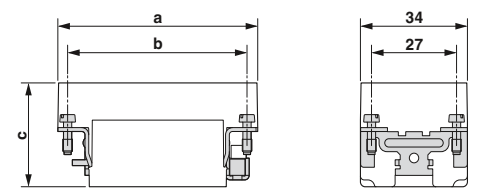

Dimensional drawing

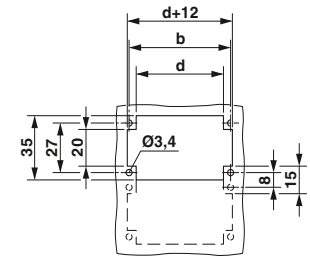

Panel cutout

	a	b	c	d
① Socket	84.5	77.5	34	72
① Plug	84.5	77.5	34	72
② Socket	84.5	77.5	34	72
② Plug	84.5	77.5	34	72
③ Socket	84	77.4	49.7	72
③ Plug	84	77.4	46.3	72

Accessories



Coding profiles
From page 638



Replacement PE screws
From page 640



Replacement PE terminal block base
From page 640

Heavy-duty connectors

HEAVYCON B - contact inserts

K series

Combination applications

400 - 830 V, 40 - 80 A

Connection technology:

- Power and control contacts
- Screw connection

To determine the corresponding housing, see cross-reference list on page 482.

Notes:
For accessories, see from page 634
Only operate connectors when there is no load/the power is switched off
For assembly instructions, see phoenixcontact.net/products
For connection technologies, see page 4
1) For solid conductors and stranded wires with wire end protection



Type	Technical data						
	① HC-K 4/0-E...S		② HC-K 4/8-E...S		③ HC-K 6/12-E...S		
	Power contacts	Control contacts	Power contacts	Control contacts	Power contacts	Control contacts	
Approvals	CE ENEC 94		CE ENEC 94		CE ENEC 94		
IEC data							
Rated current	A	80	-	80	16	40	10
Surge voltage category			III		III		III
Pollution degree		3		3		3	
Rated voltage (III/3) contacts	V	830	-	400	400	690	230 / 400
Rated surge voltage, contacts	kV	8	-	6	6	8	4
Connection cross section	mm ²	1.5 ... 16	-	1.5 ... 16	0.5 ... 2.5	2.5 ... 8	0.2 ... 2.5
UL data							
Rated voltage	V	600	-	600	-	600	-
Rated current	A	-	-	-	-	-	-
Connection cross section	AWG	-	-	-	-	-	-
CSA / cUL data							
Rated voltage	V	600	-	600	-	600	-
Rated current	A	80	-	80	-	40	-
Connection cross section	AWG	5	-	16-4	-	13-7	-
Material data							
Contact carrier material		PC		PA		PC	
Inflammability class in acc. with UL 94		V0		HB		V0	
Contact material		Cu alloy		Cu alloy		Cu alloy	
Contact surface material		Ag	-	Ag	Ag	Ag	Ag
Temperature data							
Ambient temperature range	°C	-40 ... 125		-40 ... 125		-40 ... 125	
General data							
Connection method		Screw connection	-	Screw connection	Screw connection	Axial screw connection	Screw connection
Hexagonal socket	mm	-	-	-	-	2	-
Stripping length	mm	-	-	14	7	8	10
No. of pos.		4	-	4	8	6	12
Contact numbering		1 - 4	-	1 - 4	1 - 8	1 - 6	1 - 12
Insertion/withdrawal cycles		≥ 500		≥ 500		≥ 500	

Derating curves

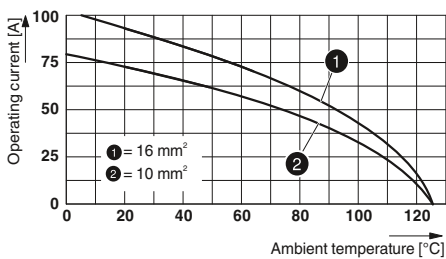



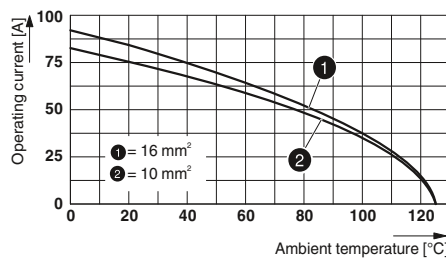

HC-K 4/0-E...S

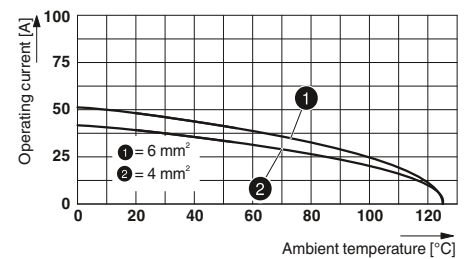

HC-K 4/8-E...S

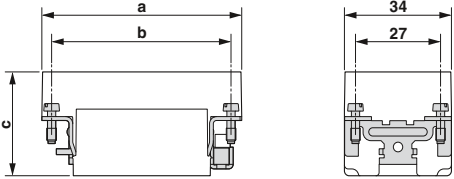

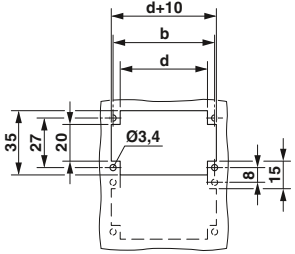
HC-K 6/12-E...S

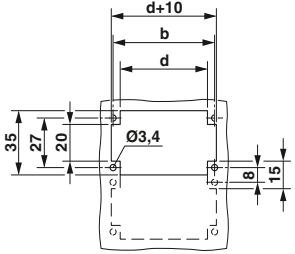
Description	Pos.	Number	Size	Type	Ordering data		Pcs. / Pkt.	Dimensions (in mm)																																			
					Socket	Plug																																					
Screw connection ¹⁾ 	4	1 - 4	B16 / B32	① HC-K 4/0-E...S	1679427	1679414	1																																				
Screw connection ¹⁾ 	4 / 8	1 - 4	B24 / B48	② HC-K 4/8-E...S	1679320	1679333	1	Dimensional drawing 																																			
Axial screw connection 	6 / 12	1 - 6	B16 / B32	③ HC-K 6/12-E...S	1636363	1636350	1	Panel cutout 																																			
<table border="1"> <thead> <tr> <th></th> <th>a</th> <th>b</th> <th>c</th> <th>d</th> </tr> </thead> <tbody> <tr> <td>① Socket</td> <td>84.5</td> <td>77.5</td> <td>44.2</td> <td>72</td> </tr> <tr> <td>① Plug</td> <td></td> <td></td> <td>42</td> <td></td> </tr> <tr> <td>② Socket</td> <td>111</td> <td>104</td> <td>44.2</td> <td>98</td> </tr> <tr> <td>② Plug</td> <td></td> <td></td> <td>42</td> <td></td> </tr> <tr> <td>③ Socket</td> <td>84.1</td> <td>77.5</td> <td>47</td> <td>68.5</td> </tr> <tr> <td>③ Plug</td> <td>84.5</td> <td></td> <td>47.2</td> <td></td> </tr> </tbody> </table>										a	b	c	d	① Socket	84.5	77.5	44.2	72	① Plug			42		② Socket	111	104	44.2	98	② Plug			42		③ Socket	84.1	77.5	47	68.5	③ Plug	84.5		47.2	
	a	b	c	d																																							
① Socket	84.5	77.5	44.2	72																																							
① Plug			42																																								
② Socket	111	104	44.2	98																																							
② Plug			42																																								
③ Socket	84.1	77.5	47	68.5																																							
③ Plug	84.5		47.2																																								

Accessories



Coding elements
From page 639



Replacement PE screws
From page 640

Heavy-duty connectors

HEAVYCON B - contact inserts

K series

Combination applications

400 - 690 V, 16 - 40 A

Connection technology:

- Power and control contacts
- Crimp connection

To determine the corresponding housing, see cross-reference list on page 482.

Notes:
For accessories, see from page 634
Order crimp contacts separately
Only operate connectors when there is no load/the power is switched off
For assembly instructions, see phoenixcontact.net/products
For connection technologies, see page 4



Type	Technical data						
	① HC-K 6/36-E...C		② HC-K12/ 2-E...C		③ HC-K 8/24-E...C		
	Power contacts	Control contacts	Power contacts	Control contacts	Power contacts	Control contacts	
Approvals	CE ENEC 94		CE ENEC 94		CE ENEC 94		
IEC data							
Rated current	A	40	10	40	10	16	10
Surge voltage category		III		III		III	
Pollution degree		3		3		3	
Rated voltage (III/3) contacts	V	690	160	690	250	230 / 400	160
Rated surge voltage, contacts	kV	8	2.5	8	4	4	2.5
Connection cross section	mm ²	1.5 ... 6	0.14 ... 2.5	1.5 ... 6	0.14 ... 2.5	0.5 ... 4	0.14 ... 2.5
UL data							
Rated voltage	V	600	-	600	-	600	-
Rated current	A	-	-	-	-	-	-
Connection cross section	AWG	-	-	-	-	-	-
CSA / cUL data							
Rated voltage	V	600	-	600	-	600	-
Rated current	A	40	-	40	-	16	-
Connection cross section	AWG	13-9	-	13-8	-	20-12	-
Material data							
Contact carrier material		PC		PC		PA	
Inflammability class in acc. with UL 94		V0		V0		V0	
Contact material		Cu alloy		Cu alloy		Cu alloy	
Contact surface material		Ag	Ag (alternatively Au)	Ag	Ag (alternatively Au)	Ag (alternatively Au)	Ag (alternatively Au)
Temperature data							
Ambient temperature range	°C	-40 ... 125		-40 ... 125		-40 ... 125	
General data							
Connection method		Crimp connection	Crimp connection	Crimp connection	Crimp connection	Crimp connection	Crimp connection
Stripping length	mm	9	8	9	8	7.5	8
No. of pos.		6	36	12	2	8	24
Contact numbering		1 - 6	1 - 36	1 - 12	1 - 2	1 - 8	1 - 24
Insertion/withdrawal cycles		≥ 500		≥ 500		≥ 500	

Derating curves

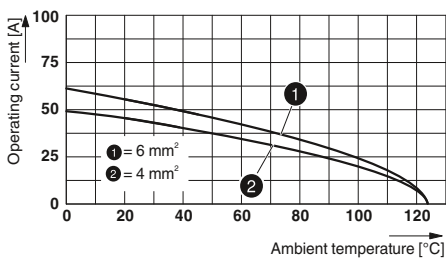

HC-K 6/36 E...C

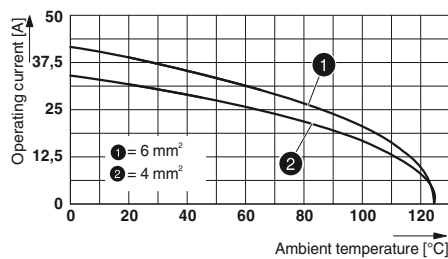

HC-K 12/2 E...C

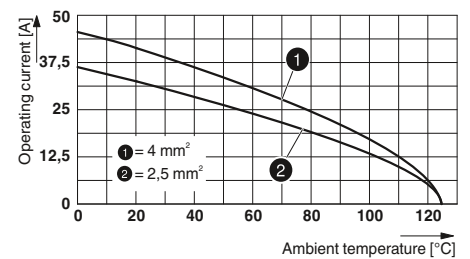

HC-K 8/24 E...C

Description	Pos.	Number	Size	Ordering data			
				Type	Order No. Socket	Order No. Plug	Pcs. / Pkt.
Crimp connection CK 4,0/CK 1,6							
	6 / 36	1 - 6	B16 / B32	① HC-K 6/36-E...C	1663389	1663376	1
Crimp connection CK 4,0/CK 1,6							
	12 / 2	1 - 12	B16 / B32	② HC-K12/ 2-E...C	1663347	1663334	1
Crimp connection CK 2,5/CK 1,6							
	8 / 24	1 - 8	B10	③ HC-K 8/24-E...C	1663321	1663318	1
Turned crimp contacts CK 1,6 Silver-plated							
			Cross section mm² / AWG 0.14 - 0.37 / 26 - 22 0.5 / 20 0.75 / 18 0.75 - 1 / 18 1.5 / 16 2.5 / 14	CK1,6-ED-0,37... AG CK1,6-ED-0,50... AG CK1,6-ED-0,75... AG CK1,6-ED-1,00... AG CK1,6-ED-1,50... AG CK1,6-ED-2,50... AG	1663394 1663404 1663417 1663420 1663433 1663446	1663336 1663349 1663352 1663365 1663378 1663381	100 100 100 100 100 100
Turned crimp contacts CK 2,5 Silver-plated							
			Cross section mm² / AWG 0.5 / 20 0.75 / 18 0.75 - 1 / 18 1.5 / 16 2.5 / 14 4 / 12	CK2,5-ED-0,50... AG CK2,5-ED-0,75... AG CK2,5-ED-1,00... AG CK2,5-ED-1,50... AG CK2,5-ED-2,50... AG CK2,5-ED-4,00... AG	1663640 1663653 1663666 1663679 1663682 1663705	1663572 1663585 1663598 1663608 1663611 1663637	100 100 100 100 100 100
Turned crimp contacts CK 4,0 Silver-plated							
			Cross section mm² / AWG 1.5 / 16 2.5 / 14 4 / 12 6 / 10 10 / 8	CK4,0-ED-1,50... AG CK4,0-ED-2,50... AG CK4,0-ED-4,00... AG CK4,0-ED-6,00... AG CK4,0-ED-10,00... AG	1663271 1663284 1663297 1663307 1586183	1663239 1663242 1663255 1663268 1586198	25 25 25 25 25

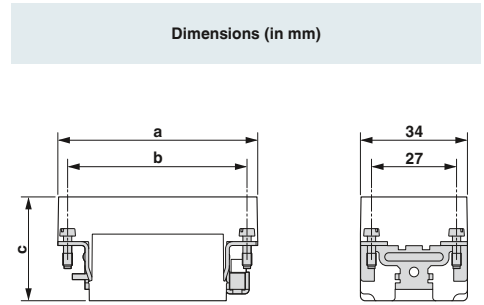

Dimensional drawing

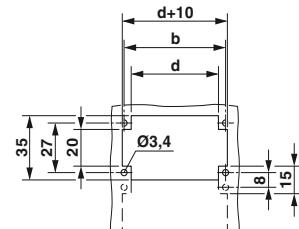

	a	b	c	d
① Socket	84.5	77.5	41.5	68.5
① Plug			39	
② Socket	84.5	77.5	41.5	72
② Plug			39.6	
③ Socket	64	57	38	49
③ Plug			36	

Accessories



Crimping tools
From page 636



Coding elements
From page 639



Crimp contacts, gold-plated
phoenixcontact.net/products



Replacement PE screws
From page 640

Heavy-duty connectors

HEAVYCON B - contact inserts



HEAVYCON modular offers space and cost savings by combining several connectors into one. The modular inserts fit in HC-B size housings (HC-EVO, HC-STA, HC-ADV, etc.). Pin and socket modules can be freely combined and are polarized to prevent mismatching.

Lower and uppercase letters on the frames (A, B, .../a, b, ...) enable assignment on the cable and mounting side. The frames are available for 2 to 6 single modules. A double module requires the space of two single modules.



TYPE	HC-M-HS200/40-MOD...	HC-M-HS200/70-MOD...	HC-M-HS-MOD...	HC-M-02-HS-70/...-MOD...
Comments	200 A axial connection module	200 A axial connection module	100 A axial connection module	70 A axial connection module
Number of positions	1	1	2	2
Rated current [A]	200	200	100	70
Rated voltage [V]	1000	1000	1000	1000
Conductor cross section	25 ... 40 mm ²	40 ... 70 mm ²	16 ... 35 mm ²	6 ... 22 mm ²
Connection method	Axial screw connection	Axial screw connection	Axial screw connection	Axial screw connection
Number of module slots	2	2	2	1
Page	550	550	552	552



TYPE	HC-M-02-MOD...	HC-M-02-MOD...C	HC-M-03-MOD...C	HC-M-04-MOD...C
Comments	40 A axial connection module	Crimp connection module	Crimp connection module	Crimp connection module
Number of positions	2	2	3	4
Rated current [A]	70	40	40	40
Rated voltage [V]	1000	1000	500	830
Conductor cross section	2.5 ... 8 mm ²	1.5 ... 10 mm ²	1.5 ... 6 mm ²	1.5 ... 6 mm ²
Connection method	Axial screw connection	Crimp connection CK 4,0	Crimp connection CK 4,0	Crimp connection CK 4,0
Number of module slots	1	1	1	1
Page	552	554	554	554



TYPE	HC-M-03/04-MOD...C	HC-M-HV-MOD...	HC-M-06P-MOD...	HC-M-06-MOD...
Comments	Crimp connection module	High-voltage module	Crimp connection module	Crimp connection module
Number of positions	3 power contacts	2	6	6
Rated current [A]	40/10	16	16	16
Rated voltage [V]	830/830	2900/5000	830	500
Conductor cross section	1.5 ... 6 mm ² /0.14 ... 2.5 mm ²	0.5 ... 4 mm ²	0.5 ... 4 mm ²	0.5 ... 4 mm ²
Connection method	Crimp connection CK 1,6	Crimp connection CK 2,5	Crimp connection CK 2,5	Crimp connection CK 2,5
Number of module slots	1	2	1	1
Page	554	556	556	556



TYPE	HC-M-08-MOD...	HC-M-20-MOD...	HC-M-12-MOD...	HC-M-17-MOD...
Comments	Crimp connection module	Crimp connection module	Crimp connection module	Crimp connection module
Number of positions	8	20	12	17
Rated current [A]	16	16	10	10
Rated voltage [V]	400	500	250	160
Conductor cross section	0.5 ... 4 mm ²	0.5 ... 4 mm ²	0.14 ... 2.5 mm ²	0.14 ... 2.5 mm ²
Connection method	Crimp connection CK 2,5	Crimp connection CK 2,5	Crimp connection CK 1,6	Crimp connection CK 1,6
Number of module slots	1	2	1	1
Page	556	556	558	558



TYPE	HC-M-EMV-MOD...	HC-M-EMV-.../3-9,5	HC-M-25-MOD...	HC-M-08-GBIT-MOD...C
Comments	EMC bus module	EMC connector	Crimp connection module	Crimp connection module
Number of positions	-	2 x 4	25	8
Rated current [A]	-	16	5	5
Rated voltage [V]	-	42	50	50
Conductor cross section	-	0.14 ... 2.5 mm ²	0.08 ... 0.5 mm ²	0.08 ... 0.5 mm ²
Connection method	-	Crimp connection CK 1,6	Crimp connection VS 1,0	Crimp connection VS 1,0
Number of module slots	2	-	1	1
Page	558	558	560	560



TYPE	HC-M-DSUB09/02T-MOD...	HC-M-DSUB09/02T-MOD...	HC-M-PN2-MOD...	HC-M-PN3-MOD...
Comments	PROFIBUS module	PROFIBUS module	Pneumatic module	Pneumatic module
Number of positions	2	2	2	3
Rated current [A]	5	5	-	-
Rated voltage [V]	50	50	-	-
Conductor cross section	0.09 ... 0.5 mm ²	0.09 ... 0.5 mm ²	-	-
Connection method	Screw connection	Screw connection	Pneumatic hose connection	Pneumatic hose connection
Number of module slots	1	1	1	1
Page	560	560	564	564



TYPE	HC-M-05-MOD...	HC-M-04-MOD...	HC-M-BM	HC-M-MHR...
Comments	Spring connection module	Coaxial module	Dummy module	Hinged retaining frame
Number of positions	5	1.5	-	-
Rated current [A]	16	16	-	-
Rated voltage [V]	400	50	-	-
Conductor cross section	0.14 ... 2.5 mm ²	-	-	-
Connection method	Spring connection	Solder and crimp connection	-	-
Number of module slots	1	1	1	-
Page	562	562	569	566

Heavy-duty connectors

HEAVYCON B - contact inserts

Modular contact inserts, high-current modules

1000 V, 200 A

Connection technology:
– Axial screw connection

To determine the corresponding housing, see cross-reference list on page 482.

Notes:
For accessories, see from page 634
Only operate connectors when there is no load/the power is switched off
For assembly instructions, see phoenixcontact.net/products
For connection technologies, see page 4
1) Housing height ≥ 72 mm



Type	Technical data			
	① HC-M-HS 200/70-MOD-...	② HC-M-HS 200/70-MOD-...-PE	③ HC-M-HS 200/40-MOD-...	④ HC-M-HS 200/40-MOD-...-PE
Approvals	ERC	ERC	ERC	ERC
IEC data				
Rated current, contacts (at 40°C)	A	200	200	200
Surge voltage category		III	-	III
Pollution degree		3	-	3
Rated voltage (III/3) contacts	V	1000	-	1000
Rated surge voltage, contacts	kV	8	-	8
Connection cross section	mm ²	40 ... 70	40 ... 70	25 ... 40
UL data				
Rated voltage	V	600	600	600
Rated current	A	200	200	200
Connection cross section	AWG	2	2	2
CSA / cUL data				
Rated voltage	V	-	-	-
Rated current	A	-	-	-
Connection cross section	AWG	-	-	-
Material data				
Contact carrier material		PC	PC	PC
Inflammability class in acc. with UL 94		V0	V0	V0
Contact material		Copper alloy	Copper alloy	Copper alloy
Contact surface material		Ag	Ag	Ag
Temperature data				
Ambient temperature range	°C	-40 ... 125	-40 ... 125	-40 ... 125
General data				
Connection method		Axial screw connection	Axial screw connection	Axial screw connection
Hexagonal socket	mm	5	5	5
Stripping length	mm	16	16	16
No. of pos.		1	1	1
Contact numbering		-	-	-
Insertion/withdrawal cycles		≥ 500	≥ 500	≥ 500



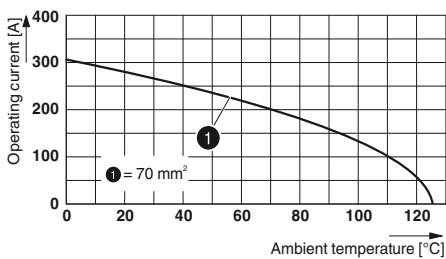

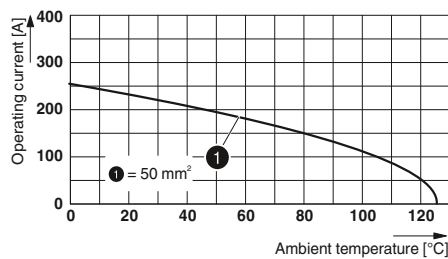

Derating curves

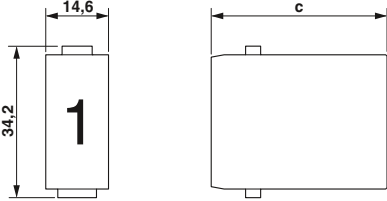

HC-M-HS 200/70-MOD-...

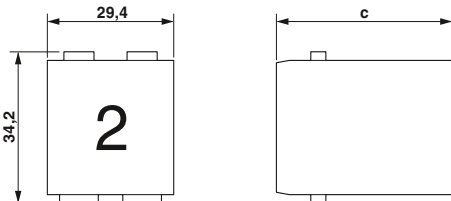

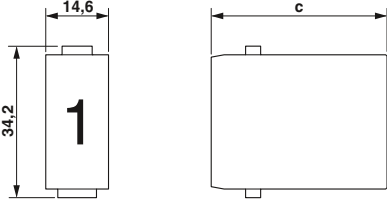
HC-M-HS 200/40-MOD-...

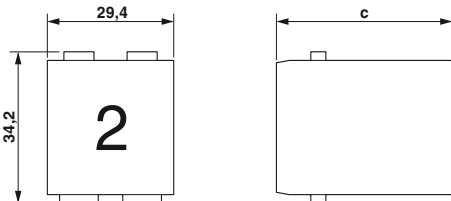
Description	Pos.	Number	Slots	Type	Ordering data		Pcs. / Pkt.	Dimensions (in mm)	
					Socket	Plug			
Axial screw connection ¹⁾ 	1		2	① HC-M-HS 200/70-MOD-...	1636897	1636884	1		1 module slot
Axial screw connection ¹⁾ 	1		2	② HC-M-HS 200/70-MOD-...-PE	1636910	1636907	1		2 module slots
Axial screw connection ¹⁾ 	1		2	③ HC-M-HS 200/40-MOD-...	1637171	1637168	1		1 module slot
Axial screw connection ¹⁾ 	1		2	④ HC-M-HS 200/40-MOD-...-PE	1637197	1637184	1		2 module slots

	a	b	c	d
① Socket			60	
① Plug	29.4		54.5	
② Socket			54.3	
② Plug	29.4		54.5	
③ Socket			60	
③ Plug	29.4		54.5	
④ Socket			54.3	
④ Plug	29.4		54.5	

Accessories



Hinged retaining frames
From page 566



Dummy module
From page 569

Heavy-duty connectors

HEAVYCON B - contact inserts

Modular contact inserts, 2-pos. modules

1000 V, 40 - 100 A

Connection technology:
– Axial screw connection

To determine the corresponding housing,
see cross-reference list on page 482.

Notes:
For accessories, see from page 634
Only operate connectors when there is no load/the power is switched off
For assembly instructions, see phoenixcontact.net/products
For connection technologies, see page 4
1) Housing height ≥ 72 mm



Type	Technical data			
	① HC-M-HS-MOD-...	② HC-M-02-HS-70/22-MOD-...	③ HC-M-02-HS-70/16-MOD-...	④ HC-M-02-MOD-...
Approvals				
IEC data				
Rated current, contacts (at 40°C)	A	100	70	40
Surge voltage category		III	III	III
Pollution degree		3	3	3
Rated voltage (III/3) contacts	V	1000	1000	1000
Rated surge voltage, contacts	kV	8	8	8
Connection cross section	mm ²	16 ... 35	14 ... 22	6 ... 16
UL data				
Rated voltage	V	600	600	600
Rated current	A	100	70	40
Connection cross section	AWG	2	4	8
CSA / cUL data				
Rated voltage	V	600	-	600
Rated current	A	100	-	40
Connection cross section	AWG	2	-	8
Material data				
Contact carrier material		PC	PC	PC
Inflammability class in acc. with UL 94		V0	V0	V0
Contact material		Copper alloy	Copper alloy	Copper alloy
Contact surface material		Ag	Ag	Ag
Temperature data				
Ambient temperature range	°C	-40 ... 125	-40 ... 125	-40 ... 125
General data				
Connection method		Axial screw connection	Axial screw connection	Axial screw connection
Hexagonal socket	mm	4	2.5	2.5
Stripping length	mm	13	11	11
No. of pos.		2	2	2
Contact numbering		1 - 2	1 - 2	1 - 2
Insertion/withdrawal cycles		≥ 500	≥ 500	≥ 500

Derating curves

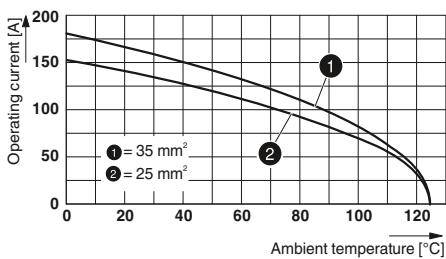

HC-M-HS-MOD-...

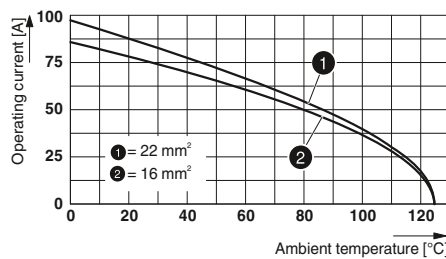

HC-M-02-HS- 70/...-MOD-...

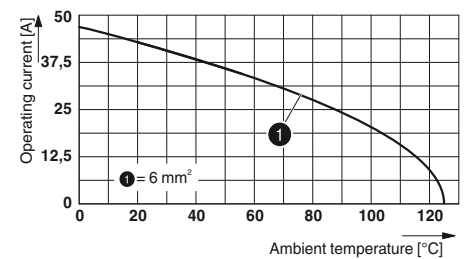

HC-M-02-MOD-...

Description	Pos.	Number	Slots	Type	Ordering data		Pcs. / Pkt.	Dimensions (in mm)																																																
					Socket	Plug																																																		
Axial screw connection ¹⁾ 	2	1 - 2	2	① HC-M-HS-MOD-...	1605001	1605000	1																																																	
Axial screw connection ¹⁾ 	2	1 - 2	1	② HC-M-02-HS-70/22-MOD-...	1585731	1585728	2	1 module slot 																																																
Axial screw connection ¹⁾ 	2	1 - 2	1	③ HC-M-02-HS-70/16-MOD-...	1585715	1585702	2	2 module slots 																																																
Axial screw connection ¹⁾ 	2	1 - 2	1	④ HC-M-02-MOD-...	1679359	1679346	2	<table border="1"> <thead> <tr> <th></th> <th>a</th> <th>b</th> <th>c</th> <th>d</th> </tr> </thead> <tbody> <tr> <td>① Socket</td> <td></td> <td></td> <td>50.3</td> <td></td> </tr> <tr> <td>① Plug</td> <td>29.4</td> <td></td> <td>49</td> <td></td> </tr> <tr> <td>② Socket</td> <td>14.6</td> <td></td> <td>46.5</td> <td></td> </tr> <tr> <td>② Plug</td> <td></td> <td></td> <td>45</td> <td></td> </tr> <tr> <td>③ Socket</td> <td>14.6</td> <td></td> <td>46.5</td> <td></td> </tr> <tr> <td>③ Plug</td> <td></td> <td></td> <td>45</td> <td></td> </tr> <tr> <td>④ Socket</td> <td>14.6</td> <td></td> <td>40.6</td> <td></td> </tr> <tr> <td>④ Plug</td> <td></td> <td></td> <td>41.8</td> <td></td> </tr> </tbody> </table>					a	b	c	d	① Socket			50.3		① Plug	29.4		49		② Socket	14.6		46.5		② Plug			45		③ Socket	14.6		46.5		③ Plug			45		④ Socket	14.6		40.6		④ Plug			41.8	
	a	b	c	d																																																				
① Socket			50.3																																																					
① Plug	29.4		49																																																					
② Socket	14.6		46.5																																																					
② Plug			45																																																					
③ Socket	14.6		46.5																																																					
③ Plug			45																																																					
④ Socket	14.6		40.6																																																					
④ Plug			41.8																																																					

Accessories



Hinged retaining frames
From page 566



Dummy module
From page 569

Heavy-duty connectors

HEAVYCON B - contact inserts

Modular contact inserts

500 - 1000 V, 40 A

Connection technology:

– Crimp connection CK 4,0

To determine the corresponding housing, see cross-reference list on page 482.

Notes:
For accessories, see from page 634
Order crimp contacts separately
Only operate connectors when there is no load/the power is switched off
For assembly instructions, see phoenixcontact.net/products
For connection technologies, see page 4



Technical data

Type	① HC-M-02-MOD-...C	② HC-M-03-MOD-...C	③ HC-M-04-MOD-...C	④ HC-M-03/04-MOD-...C
Approvals	ERC	ERC	ERC	ERC
IEC data				
Rated current, contacts (at 40°C)	A 40	40	40	40
Surge voltage category	III	III	III	III
Pollution degree	3	3	3	3
Rated voltage (III/3) contacts	V 1000	500	830	830
Rated surge voltage, contacts	kV 8	6	8	8
Connection cross section	mm ² 1.5 ... 10	1.5 ... 10	1.5 ... 6	1.5 ... 6
UL data				
Rated voltage	V 600	600	600	600
Rated current	A 40	40	40	-
Connection cross section	AWG 12-8	8	10	18-10
CSA / cUL data				
Rated voltage	V -	-	-	-
Rated current	A -	-	-	-
Connection cross section	AWG -	-	-	-
Material data				
Contact carrier material	PC	PC	PC	PC
Inflammability class in acc. with UL 94	V0	V0	V0	V0
Contact material	Copper alloy	Copper alloy	Copper alloy	Copper alloy
Contact surface material	Ag	Ag	Ag	-
Temperature data				
Ambient temperature range	°C -40 ... 125	-40 ... 125	-40 ... 125	-40 ... 125
General data				
Connection method	Crimp connection	Crimp connection	Crimp connection	Crimp connection
Stripping length	mm 9	9	9	9
No. of pos.	2	3	4	-
Contact numbering	1 - 2	1 - 3	1 - 4	1-3
Insertion/withdrawal cycles	≥ 500	≥ 500	≥ 500	≥ 500

Derating curves

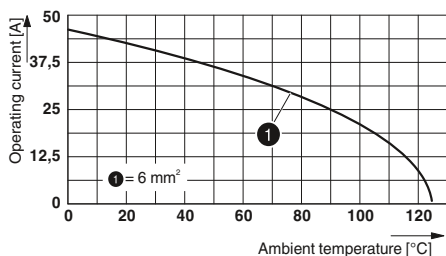

HC-M-02-MOD-...C

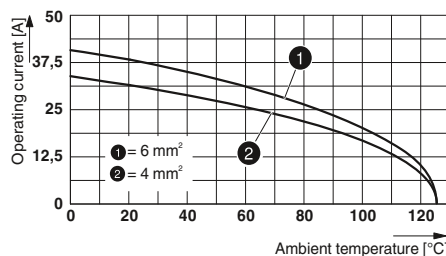

HC-M-03-MOD-...C

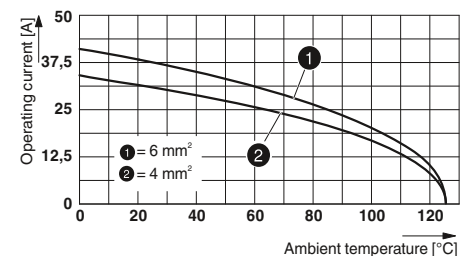

HC-M-04-MOD-...C

Description	Pos.	Number	Slots	Ordering data			Pcs. / Pkt.	Dimensions (in mm)																																																						
				Type	Socket	Plug																																																								
Crimp connection CK 4,0								<p>1 module slot</p>																																																						
	2	1 - 2	1	① HC-M-02-MOD-...C	1587519	1587506	2																																																							
Crimp connection CK 4,0													<p>2 module slots</p>																																																	
	3	1 - 3	1	② HC-M-03-MOD-...C	1645972	1645969	2																																																							
Crimp connection CK 4,0								<table border="1"> <thead> <tr> <th></th> <th>a</th> <th>b</th> <th>c</th> <th>d</th> </tr> </thead> <tbody> <tr> <td>① Socket</td> <td>14.6</td> <td></td> <td>42.4</td> <td></td> </tr> <tr> <td>① Plug</td> <td>14.6</td> <td></td> <td>43.7</td> <td></td> </tr> <tr> <td>② Socket</td> <td>14.6</td> <td></td> <td>44.7</td> <td></td> </tr> <tr> <td>② Plug</td> <td>14.6</td> <td></td> <td>43.1</td> <td></td> </tr> <tr> <td>③ Socket</td> <td>14.6</td> <td></td> <td>40.9</td> <td></td> </tr> <tr> <td>③ Plug</td> <td>14.6</td> <td></td> <td>44.6</td> <td></td> </tr> <tr> <td>④ Socket</td> <td>14.6</td> <td></td> <td>39.1</td> <td></td> </tr> <tr> <td>④ Plug</td> <td>14.6</td> <td></td> <td>44.3</td> <td></td> </tr> </tbody> </table>											a	b	c	d	① Socket	14.6		42.4		① Plug	14.6		43.7		② Socket	14.6		44.7		② Plug	14.6		43.1		③ Socket	14.6		40.9		③ Plug	14.6		44.6		④ Socket	14.6		39.1		④ Plug	14.6		44.3	
	a	b	c	d																																																										
① Socket	14.6		42.4																																																											
① Plug	14.6		43.7																																																											
② Socket	14.6		44.7																																																											
② Plug	14.6		43.1																																																											
③ Socket	14.6		40.9																																																											
③ Plug	14.6		44.6																																																											
④ Socket	14.6		39.1																																																											
④ Plug	14.6		44.3																																																											
	4	1 - 4	1	③ HC-M-04-MOD-...C	1585605	1585618	2																																																							
Crimp connection CK 4,0/CK 1,6								<table border="1"> <thead> <tr> <th></th> <th>a</th> <th>b</th> <th>c</th> <th>d</th> </tr> </thead> <tbody> <tr> <td>④ Socket</td> <td>14.6</td> <td></td> <td>42.4</td> <td></td> </tr> <tr> <td>④ Plug</td> <td>14.6</td> <td></td> <td>43.7</td> <td></td> </tr> <tr> <td>② Socket</td> <td>14.6</td> <td></td> <td>44.7</td> <td></td> </tr> <tr> <td>② Plug</td> <td>14.6</td> <td></td> <td>43.1</td> <td></td> </tr> <tr> <td>③ Socket</td> <td>14.6</td> <td></td> <td>40.9</td> <td></td> </tr> <tr> <td>③ Plug</td> <td>14.6</td> <td></td> <td>44.6</td> <td></td> </tr> <tr> <td>④ Socket</td> <td>14.6</td> <td></td> <td>39.1</td> <td></td> </tr> <tr> <td>④ Plug</td> <td>14.6</td> <td></td> <td>44.3</td> <td></td> </tr> </tbody> </table>						a	b	c	d	④ Socket	14.6		42.4		④ Plug	14.6		43.7		② Socket	14.6		44.7		② Plug	14.6		43.1		③ Socket	14.6		40.9		③ Plug	14.6		44.6		④ Socket	14.6		39.1		④ Plug	14.6		44.3						
	a	b	c	d																																																										
④ Socket	14.6		42.4																																																											
④ Plug	14.6		43.7																																																											
② Socket	14.6		44.7																																																											
② Plug	14.6		43.1																																																											
③ Socket	14.6		40.9																																																											
③ Plug	14.6		44.6																																																											
④ Socket	14.6		39.1																																																											
④ Plug	14.6		44.3																																																											
	3 / 4	1 - 3	1	④ HC-M-03/04-MOD-...C	1585786	1585799	2																																																							
Turned crimp contacts CK 1,6 Silver-plated								<table border="1"> <thead> <tr> <th></th> <th>a</th> <th>b</th> <th>c</th> <th>d</th> </tr> </thead> <tbody> <tr> <td>① Socket</td> <td>14.6</td> <td></td> <td>42.4</td> <td></td> </tr> <tr> <td>① Plug</td> <td>14.6</td> <td></td> <td>43.7</td> <td></td> </tr> <tr> <td>② Socket</td> <td>14.6</td> <td></td> <td>44.7</td> <td></td> </tr> <tr> <td>② Plug</td> <td>14.6</td> <td></td> <td>43.1</td> <td></td> </tr> <tr> <td>③ Socket</td> <td>14.6</td> <td></td> <td>40.9</td> <td></td> </tr> <tr> <td>③ Plug</td> <td>14.6</td> <td></td> <td>44.6</td> <td></td> </tr> <tr> <td>④ Socket</td> <td>14.6</td> <td></td> <td>39.1</td> <td></td> </tr> <tr> <td>④ Plug</td> <td>14.6</td> <td></td> <td>44.3</td> <td></td> </tr> </tbody> </table>						a	b	c	d	① Socket	14.6		42.4		① Plug	14.6		43.7		② Socket	14.6		44.7		② Plug	14.6		43.1		③ Socket	14.6		40.9		③ Plug	14.6		44.6		④ Socket	14.6		39.1		④ Plug	14.6		44.3						
	a	b	c	d																																																										
① Socket	14.6		42.4																																																											
① Plug	14.6		43.7																																																											
② Socket	14.6		44.7																																																											
② Plug	14.6		43.1																																																											
③ Socket	14.6		40.9																																																											
③ Plug	14.6		44.6																																																											
④ Socket	14.6		39.1																																																											
④ Plug	14.6		44.3																																																											
				CK1,6-ED-0,37... AG	1663394	1663336	100																																																							
				CK1,6-ED-0,50... AG	1663404	1663349	100																																																							
				CK1,6-ED-0,75... AG	1663417	1663352	100																																																							
				CK1,6-ED-1,00... AG	1663420	1663365	100																																																							
				CK1,6-ED-1,50... AG	1663433	1663378	100																																																							
				CK1,6-ED-2,50... AG	1663446	1663381	100																																																							
Turned crimp contacts CK 4,0 Silver-plated								<table border="1"> <thead> <tr> <th></th> <th>a</th> <th>b</th> <th>c</th> <th>d</th> </tr> </thead> <tbody> <tr> <td>④ Socket</td> <td>14.6</td> <td></td> <td>42.4</td> <td></td> </tr> <tr> <td>④ Plug</td> <td>14.6</td> <td></td> <td>43.7</td> <td></td> </tr> <tr> <td>② Socket</td> <td>14.6</td> <td></td> <td>44.7</td> <td></td> </tr> <tr> <td>② Plug</td> <td>14.6</td> <td></td> <td>43.1</td> <td></td> </tr> <tr> <td>③ Socket</td> <td>14.6</td> <td></td> <td>40.9</td> <td></td> </tr> <tr> <td>③ Plug</td> <td>14.6</td> <td></td> <td>44.6</td> <td></td> </tr> <tr> <td>④ Socket</td> <td>14.6</td> <td></td> <td>39.1</td> <td></td> </tr> <tr> <td>④ Plug</td> <td>14.6</td> <td></td> <td>44.3</td> <td></td> </tr> </tbody> </table>						a	b	c	d	④ Socket	14.6		42.4		④ Plug	14.6		43.7		② Socket	14.6		44.7		② Plug	14.6		43.1		③ Socket	14.6		40.9		③ Plug	14.6		44.6		④ Socket	14.6		39.1		④ Plug	14.6		44.3						
	a	b	c	d																																																										
④ Socket	14.6		42.4																																																											
④ Plug	14.6		43.7																																																											
② Socket	14.6		44.7																																																											
② Plug	14.6		43.1																																																											
③ Socket	14.6		40.9																																																											
③ Plug	14.6		44.6																																																											
④ Socket	14.6		39.1																																																											
④ Plug	14.6		44.3																																																											
				CK4,0-ED-1,50... AG	1663271	1663239	25																																																							
				CK4,0-ED-2,50... AG	1663284	1663242	25																																																							
				CK4,0-ED-4,00... AG	1663297	1663255	25																																																							
				CK4,0-ED-6,00... AG	1663307	1663268	25																																																							
				CK4,0-ED-10,00... AG	1586183	1586198	25																																																							

Accessories



Hinged retaining frames
From page 566



Crimping tools
From page 636



Crimp contacts, gold-plated
phoenixcontact.net/products



Dummy module
From page 569

Heavy-duty connectors

HEAVYCON B - contact inserts

Modular contact inserts

400 - 830 V, 16 A

Connection technology:

– Crimp connection CK 2,5

To determine the corresponding housing, see cross-reference list on page 482.

Notes:
For accessories, see from page 634
Order crimp contacts separately
Only operate connectors when there is no load/the power is switched off
For assembly instructions, see phoenixcontact.net/products
For connection technologies, see page 4
1) Housing height ≥ 72 mm



Technical data						
Type		① HC-M-HV-MOD-...	② HC-M-06P-MOD-...	③ HC-M-06-MOD-...	④ HC-M-08-MOD-...	⑤ HC-M-20-MOD-...
Approvals		ERE	ERE	ERE	ERE	ERE
IEC data						
Rated current, contacts (at 40°C)	A	16	16	16	16	16
Surge voltage category		III	III	III	III	III
Pollution degree		3	3	3	3	3
Rated voltage (III/3) contacts	V	2900 / 5000	830	500	400	500
Rated surge voltage, contacts	kV	15	8	6	6	6
Connection cross section	mm ²	0.5 ... 4	0.5 ... 4	0.5 ... 4	0.5 ... 4	0.5 ... 4
UL data						
Rated voltage	V	-	600	600	600	600
Rated current	A	-	16	-	16	16
Connection cross section	AWG	-	12	-	12	12
CSA / cUL data						
Rated voltage	V	-	-	600	-	-
Rated current	A	-	-	32	-	-
Connection cross section	AWG	-	-	16-10	-	-
Material data						
Contact carrier material		PC / PTFE	PC	PC	PC	PC
Inflammability class in acc. with UL 94		V0	V0	V0	V0	V0
Contact material		Copper alloy	Copper alloy	Copper alloy	Copper alloy	Copper alloy
Contact surface material		Ag (alternatively Au)	Ag (alternatively Au)	Ag (alternatively Au)	Ag (alternatively Au)	Ag (alternatively Au)
Ambient conditions						
Ambient temperature range	°C	-40 ... 125	-40 ... 125	-40 ... 125	-40 ... 125	-40 ... 125
General data						
Connection method		Crimp connection	Crimp connection	Crimp connection	Crimp connection	Crimp connection
Stripping length	mm	9.5	7.5	7.5	7.5	7.5
No. of pos.		2	6	6	8	20
Contact numbering		I, II	1 - 6	1 - 6	1 - 8	1 - 20
Insertion/withdrawal cycles		≥ 500	≥ 500	≥ 500	≥ 500	≥ 500

Derating curves

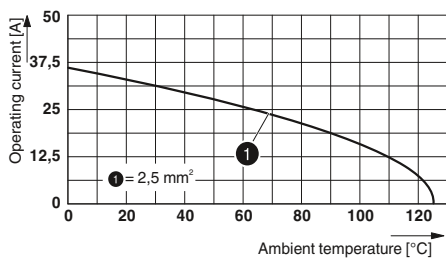



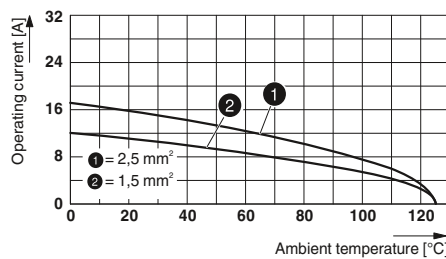



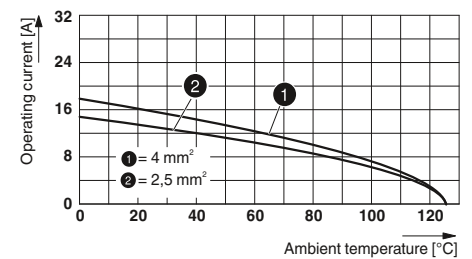

HC-M-HV-MOD-...

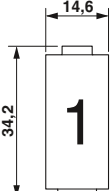
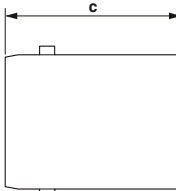

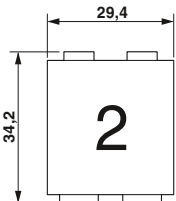
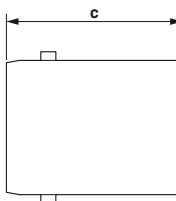
HC-M-06-MOD-...

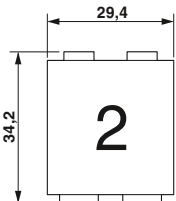
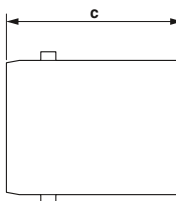

HC-M-20-MOD-...

Description	Pos.	Number	Slots	Ordering data			Pcs. / Pkt.	Dimensions (in mm)																																																								
				Type	Socket	Plug																																																										
Crimp connection CK 2,5¹⁾ 	2	I, II	2	① HC-M-HV-MOD-...	1604999	1604998	1	 	1 module slot																																																							
Crimp connection CK 2,5 	6	1 - 6	1	② HC-M-06P-MOD-...	1636460	1636457	2	 	2 module slots																																																							
Crimp connection CK 2,5 	6	1 - 6	1	③ HC-M-06-MOD-...	1663462	1663459	2	 	2 module slots																																																							
Crimp connection CK 2,5 	8	1 - 8	1	④ HC-M-08-MOD-...	1605003	1605002	2	<table border="1"> <thead> <tr> <th></th> <th>a</th> <th>b</th> <th>c</th> <th>d</th> </tr> </thead> <tbody> <tr> <td>① Socket</td> <td></td> <td></td> <td>62</td> <td></td> </tr> <tr> <td>① Plug</td> <td>29.4</td> <td></td> <td>59</td> <td></td> </tr> <tr> <td>② Socket</td> <td></td> <td></td> <td>37.4</td> <td></td> </tr> <tr> <td>② Plug</td> <td>14.6</td> <td></td> <td>39.2</td> <td></td> </tr> <tr> <td>③ Socket</td> <td></td> <td></td> <td>35.8</td> <td></td> </tr> <tr> <td>③ Plug</td> <td>14.6</td> <td></td> <td>34</td> <td></td> </tr> <tr> <td>④ Socket</td> <td></td> <td></td> <td>35.8</td> <td></td> </tr> <tr> <td>④ Plug</td> <td>14.6</td> <td></td> <td>34.5</td> <td></td> </tr> <tr> <td>⑤ Socket</td> <td></td> <td></td> <td>39.95</td> <td></td> </tr> <tr> <td>⑤ Plug</td> <td>29.4</td> <td></td> <td>37.6</td> <td></td> </tr> </tbody> </table>		a	b	c	d	① Socket			62		① Plug	29.4		59		② Socket			37.4		② Plug	14.6		39.2		③ Socket			35.8		③ Plug	14.6		34		④ Socket			35.8		④ Plug	14.6		34.5		⑤ Socket			39.95		⑤ Plug	29.4		37.6		
	a	b	c	d																																																												
① Socket			62																																																													
① Plug	29.4		59																																																													
② Socket			37.4																																																													
② Plug	14.6		39.2																																																													
③ Socket			35.8																																																													
③ Plug	14.6		34																																																													
④ Socket			35.8																																																													
④ Plug	14.6		34.5																																																													
⑤ Socket			39.95																																																													
⑤ Plug	29.4		37.6																																																													
Crimp connection CK 2,5 	20	1 - 20	2	⑤ HC-M-20-MOD-...	1636936	1636923	1																																																									
Turned crimp contacts CK 2,5 Silver-plated 																																																																
			Cross section mm² / AWG 0.5 / 20 0.75 / 18 0.75 - 1 / 18 1.5 / 16 2.5 / 14 4 / 12	CK2,5-ED-0,50... AG CK2,5-ED-0,75... AG CK2,5-ED-1,00... AG CK2,5-ED-1,50... AG CK2,5-ED-2,50... AG CK2,5-ED-4,00... AG	1663640 1663653 1663666 1663679 1663682 1663705	1663572 1663585 1663598 1663608 1663611 1663637	100 100 100 100 100 100																																																									

Accessories



Hinged retaining frames
From page 566



Crimping tools
From page 636



Crimp contacts, gold-plated
phoenixcontact.net/products



Dummy module
From page 569

Heavy-duty connectors

HEAVYCON B - contact inserts

Modular contact inserts

50 - 250 V, 10 A

Connection technology:

– Crimp connection CK 1,6

To determine the corresponding housing, see cross-reference list on page 482.

Notes:
For accessories, see from page 634
Order crimp contacts separately
Only operate connectors when there is no load/the power is switched off
For assembly instructions, see phoenixcontact.net/products
For connection technologies, see page 4
1) Housing height ≥ 72 mm



Type	Technical data			
	① HC-M-12-MOD-...	② HC-M-17-MOD-...	③ HC-M-EMV-MOD-...	④ HC-M-EMV-.../3-9,5
Approvals	ERC EAC	ERC EAC	UL US EAC	UL US EAC
IEC data				
Rated current, contacts (at 40°C)	A	10	10	10
Surge voltage category		III	III	III
Pollution degree		3	3	3
Rated voltage (III/3) contacts	V	250	160	50
Rated surge voltage, contacts	kV	3	2.5	0.8
Connection cross section	mm ²	0.14 ... 2.5	0.14 ... 2.5	0.14 ... 2.5
UL data				
Rated voltage	V	600	250	42
Rated current	A	-	10	10
Connection cross section	AWG	-	14	16
CSA / cUL data				
Rated voltage	V	600	-	42
Rated current	A	12	-	9
Connection cross section	AWG	26-14	-	16
Material data				
Contact carrier material		PC	PC	PC
Inflammability class in acc. with UL 94		V0	V0	V0
Contact material		Copper alloy	Copper alloy	Copper alloy
Contact surface material		Ag (alternatively Au)	Ag (alternatively Au)	Ag (alternatively Au)
Temperature data				
Ambient temperature range	°C	-40 ... 125	-40 ... 125	-40 ... 85
General data				
Connection method		Crimp connection	Crimp connection	Crimp connection
Stripping length	mm	8	8	8
No. of pos.		12	17	4
Contact numbering		1 - 12	1 - 17	1 - 4
Insertion/withdrawal cycles		≥ 500	≥ 500	≥ 500



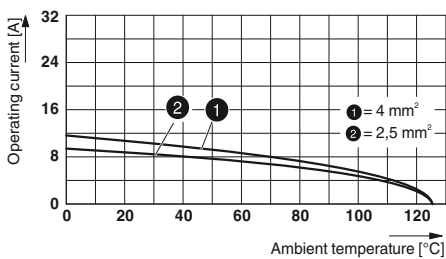



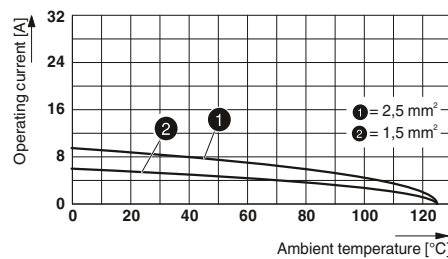

Derating curves

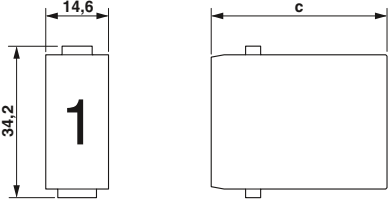

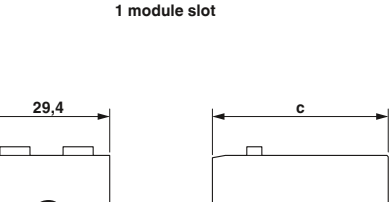
HC-M-12-MOD-...

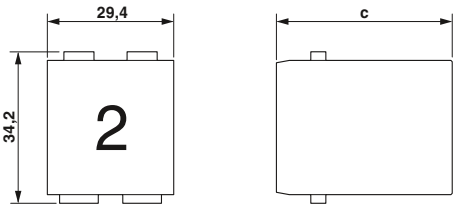

HC-M-17-MOD-...

Description	Pos.	Number	Slots	Ordering data			Pcs. / Pkt.	Dimensions (in mm)																																																	
				Type	Socket	Plug																																																			
Crimp connection CK 1,6 	12	1 - 12	1	① HC-M-12-MOD-...	1663323	1663310	2																																																		
Crimp connection CK 1,6 	17	1 - 17	1	② HC-M-17-MOD-...	1636486	1636473	2																																																		
EMC module¹⁾ 			2	③ HC-M-EMV-MOD-...	1678570	1678567	2																																																		
EMC connector, crimp connection CK 1,6 	4	1 - 4		④ HC-M-EMV-.../3-9,5	1636091	1636088	1	<table border="1"> <thead> <tr> <th></th> <th>a</th> <th>b</th> <th>c</th> <th>d</th> </tr> </thead> <tbody> <tr> <td>① Socket</td> <td>14,6</td> <td></td> <td>34</td> <td></td> </tr> <tr> <td>② Socket</td> <td>14,6</td> <td></td> <td>34</td> <td></td> </tr> <tr> <td>③ Socket</td> <td>29,4</td> <td></td> <td>34</td> <td></td> </tr> <tr> <td>④ Socket</td> <td></td> <td></td> <td></td> <td></td> </tr> <tr> <td>① Plug</td> <td></td> <td></td> <td></td> <td></td> </tr> <tr> <td>② Plug</td> <td></td> <td></td> <td></td> <td></td> </tr> <tr> <td>③ Plug</td> <td></td> <td></td> <td></td> <td></td> </tr> <tr> <td>④ Plug</td> <td></td> <td></td> <td></td> <td></td> </tr> </tbody> </table>						a	b	c	d	① Socket	14,6		34		② Socket	14,6		34		③ Socket	29,4		34		④ Socket					① Plug					② Plug					③ Plug					④ Plug				
	a	b	c	d																																																					
① Socket	14,6		34																																																						
② Socket	14,6		34																																																						
③ Socket	29,4		34																																																						
④ Socket																																																									
① Plug																																																									
② Plug																																																									
③ Plug																																																									
④ Plug																																																									
Turned crimp contacts CK 1,6 Silver-plated 								<table border="1"> <thead> <tr> <th></th> <th>a</th> <th>b</th> <th>c</th> <th>d</th> </tr> </thead> <tbody> <tr> <td>① Socket</td> <td>14,6</td> <td></td> <td>34</td> <td></td> </tr> <tr> <td>② Socket</td> <td>14,6</td> <td></td> <td>34</td> <td></td> </tr> <tr> <td>③ Socket</td> <td>29,4</td> <td></td> <td>34</td> <td></td> </tr> <tr> <td>④ Socket</td> <td></td> <td></td> <td></td> <td></td> </tr> <tr> <td>① Plug</td> <td></td> <td></td> <td></td> <td></td> </tr> <tr> <td>② Plug</td> <td></td> <td></td> <td></td> <td></td> </tr> <tr> <td>③ Plug</td> <td></td> <td></td> <td></td> <td></td> </tr> <tr> <td>④ Plug</td> <td></td> <td></td> <td></td> <td></td> </tr> </tbody> </table>						a	b	c	d	① Socket	14,6		34		② Socket	14,6		34		③ Socket	29,4		34		④ Socket					① Plug					② Plug					③ Plug					④ Plug				
	a	b	c	d																																																					
① Socket	14,6		34																																																						
② Socket	14,6		34																																																						
③ Socket	29,4		34																																																						
④ Socket																																																									
① Plug																																																									
② Plug																																																									
③ Plug																																																									
④ Plug																																																									
Turned crimp contacts CK 1,6 Gold-plated 								<table border="1"> <thead> <tr> <th></th> <th>a</th> <th>b</th> <th>c</th> <th>d</th> </tr> </thead> <tbody> <tr> <td>① Socket</td> <td>14,6</td> <td></td> <td>34</td> <td></td> </tr> <tr> <td>② Socket</td> <td>14,6</td> <td></td> <td>34</td> <td></td> </tr> <tr> <td>③ Socket</td> <td>29,4</td> <td></td> <td>34</td> <td></td> </tr> <tr> <td>④ Socket</td> <td></td> <td></td> <td></td> <td></td> </tr> <tr> <td>① Plug</td> <td></td> <td></td> <td></td> <td></td> </tr> <tr> <td>② Plug</td> <td></td> <td></td> <td></td> <td></td> </tr> <tr> <td>③ Plug</td> <td></td> <td></td> <td></td> <td></td> </tr> <tr> <td>④ Plug</td> <td></td> <td></td> <td></td> <td></td> </tr> </tbody> </table>						a	b	c	d	① Socket	14,6		34		② Socket	14,6		34		③ Socket	29,4		34		④ Socket					① Plug					② Plug					③ Plug					④ Plug				
	a	b	c	d																																																					
① Socket	14,6		34																																																						
② Socket	14,6		34																																																						
③ Socket	29,4		34																																																						
④ Socket																																																									
① Plug																																																									
② Plug																																																									
③ Plug																																																									
④ Plug																																																									

Accessories



Hinged retaining frames
From page 566



Crimping tools
From page 636



Dummy module
From page 569

Heavy-duty connectors

HEAVYCON B - contact inserts

Modular contact inserts, Ethernet and D-SUB 09

50 V, 1 - 5 A

Connection technology:

- Crimp connection VS 1,0
- Screw connection

Coding pins and sockets are mandatory when using HC-M-25-MOD-... and HC-M-DSUB 09-MOD-... modules.

To determine the corresponding housing, see cross-reference list on page 482.

Notes:
For accessories, see from page 634
Order crimp contacts separately
Only operate connectors when there is no load/the power is switched off
For assembly instructions, see phoenixcontact.net/products
For connection technologies, see page 4







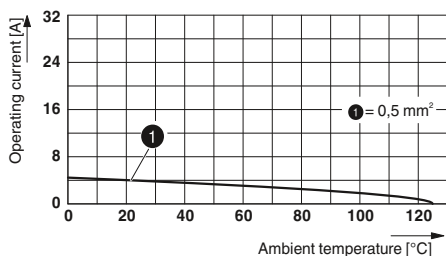

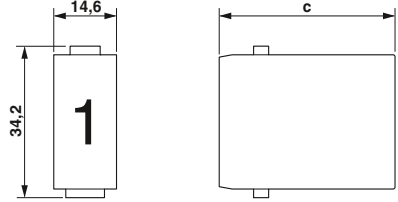

Technical data						
Type		① HC-M-25-MOD-...	② HC-M-08-GBIT-...C	③ HC-M-08-GBIT-MOD-...	④ HC-M-DSUB 09/O2T-MOD-... 2-pos.	⑤ HC-M-DSUB 09-MOD-...
Approvals		ERC	ERC	ERC	ERC	ERC
IEC data						
Rated current, contacts (at 40°C)	A	4	5	-	5	1
Surge voltage category		III	III	-	III	III
Pollution degree		3	3	-	3	3
Rated voltage (III/3) contacts	V	50	50	-	50	50
Rated surge voltage, contacts	kV	0.8	0.8	-	0.8	0.8
Connection cross section	mm ²	0.08 ... 0.5	0.08 ... 0.5	-	0.09 ... 0.5	0.08 ... 0.5
UL data						
Rated voltage	V	30	30	30	-	-
Rated current	A	-	5	5	-	-
Connection cross section	AWG	28-20	22-20	22-20	-	-
CSA / cUL data						
Rated voltage	V	-	-	-	-	-
Rated current	A	-	-	-	-	-
Connection cross section	AWG	-	-	-	-	-
Material data						
Contact carrier material		PC	PC	PC	PC	PC
Inflammability class in acc. with UL 94		V0	V0	V0	V0	V0
Contact material		Copper alloy	Copper alloy	-	Copper alloy	Copper alloy
Contact surface material		Au	Au	-	Au	Au
Ambient conditions						
Ambient temperature range	°C	-40 ... 125	-40 ... 85	-40 ... 85	-40 ... 125	-40 ... 125
General data						
Connection method		Crimp connection	Crimp connection	-	Screw connection	Crimp connection
Stripping length	mm	4.2	4.2	-	3.8	4.2
No. of pos.		25	8	-	2	9
Contact numbering		1 - 25	1 - 8	-	A, B	1 - 9
Insertion/withdrawal cycles		≥ 500	≥ 500	≥ 500	≥ 500	≥ 500

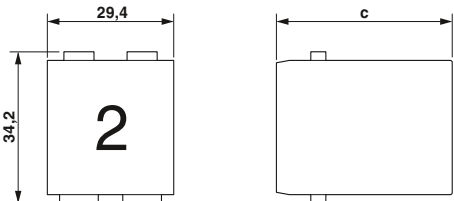
Derating curves

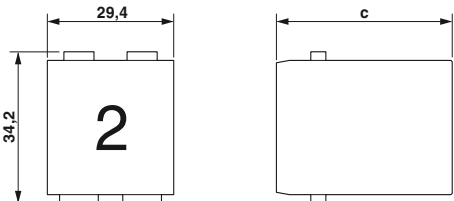

HC-M-25-MOD-...

Description	Pos.	Number	Slots	Type	Ordering data		Pcs. / Pkt.	Dimensions (in mm)																																																								
					Socket	Plug																																																										
Crimp connection VS 1,0 	25	1 - 25	1	① HC-M-25-MOD-...	1605005	1605004	2		1 module slot																																																							
Ethernet connector, crimp connection VS 1,0 	8	1 - 8	1	② HC-M-08-GBIT-...C	1587726	1587713	1		1 module slot																																																							
Module, Ethernet connector 			1	③ HC-M-08-GBIT-MOD-...	1587700	1587690	1		2 module slots																																																							
D-SUB 09 module, screw connection 	2	A,B	1	2-pos. ④ HC-M-DSUB 09/O2T-MOD-...	1636444		2	<table border="1"> <thead> <tr> <th></th> <th>a</th> <th>b</th> <th>c</th> <th>d</th> </tr> </thead> <tbody> <tr> <td>① Socket</td> <td></td> <td></td> <td>30.65</td> <td></td> </tr> <tr> <td>① Plug</td> <td>14.6</td> <td></td> <td>34</td> <td></td> </tr> <tr> <td>② Socket</td> <td></td> <td></td> <td>40.3</td> <td></td> </tr> <tr> <td>② Plug</td> <td>13.9</td> <td></td> <td>41.4</td> <td></td> </tr> <tr> <td>③ Socket</td> <td></td> <td></td> <td>28.1</td> <td></td> </tr> <tr> <td>③ Plug</td> <td>14.6</td> <td></td> <td>40.85</td> <td></td> </tr> <tr> <td>④ Socket</td> <td>14.6</td> <td></td> <td>35.2</td> <td></td> </tr> <tr> <td>④ Plug</td> <td></td> <td></td> <td></td> <td></td> </tr> <tr> <td>⑤ Socket</td> <td>14.6</td> <td></td> <td>35.2</td> <td></td> </tr> <tr> <td>⑤ Plug</td> <td></td> <td></td> <td></td> <td></td> </tr> </tbody> </table>		a	b	c	d	① Socket			30.65		① Plug	14.6		34		② Socket			40.3		② Plug	13.9		41.4		③ Socket			28.1		③ Plug	14.6		40.85		④ Socket	14.6		35.2		④ Plug					⑤ Socket	14.6		35.2		⑤ Plug					
	a	b	c	d																																																												
① Socket			30.65																																																													
① Plug	14.6		34																																																													
② Socket			40.3																																																													
② Plug	13.9		41.4																																																													
③ Socket			28.1																																																													
③ Plug	14.6		40.85																																																													
④ Socket	14.6		35.2																																																													
④ Plug																																																																
⑤ Socket	14.6		35.2																																																													
⑤ Plug																																																																
D-SUB 09 module, crimp connection VS 1,0 	9	1 - 9	1	⑤ HC-M-DSUB 09-MOD-...	1647543	1647530	2																																																									
Turned crimp contacts VS 1,0 Gold-plated 				Cross section mm ² / AWG 0.08 - 0.2 / 28 - 24 0.2 - 0.5 / 24 - 20	VS-...-CD-1,0/14,4/0,2 VS-...-CD-1,0/14,4/0,5	1688997 1688984	1688971 1688968	30 30																																																								

Accessories



Hinged retaining frames
From page 566



Crimping tools
From page 636



Dummy module
From page 569

Heavy-duty connectors

HEAVYCON B - contact inserts

Modular contact inserts

50 - 400 V, 1.5 - 16 A

Connection technology:

- Spring connection
- Coaxial contacts

To determine the corresponding housing, see cross-reference list on page 482.

Notes:
Only operate connectors when there is no load/the power is switched off
For assembly instructions, see phoenixcontact.net/products
Coaxial module with coding pin and coding socket
For connection technologies, see page 4





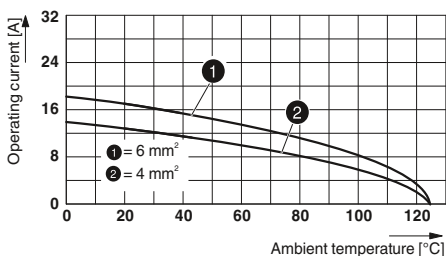

Technical data				
Type		① HC-M-05-MOD-...Z	② HC-M-04-MOD-...	
Approvals		ERC	ERC	
IEC data				
Rated current, contacts (at 40°C)	A	16	1.5	
Surge voltage category		III	III	
Pollution degree		3	3	
Rated voltage (III/3) contacts	V	400	50	
Rated surge voltage, contacts	kV	6	3	
Connection cross section	mm ²	0.14 ... 1.5	-	
UL data				
Rated voltage	V	600	600	
Rated current	A	16	-	
Connection cross section	AWG	12	-	
CSA / cUL data				
Rated voltage	V	-	-	
Rated current	A	-	-	
Connection cross section	AWG	-	-	
Material data				
Contact carrier material		PC	PC	
Inflammability class in acc. with UL 94		V0	V0	
Contact material		Copper alloy	Copper alloy	
Contact surface material		Ag	AU	
Temperature data				
Ambient temperature range	°C	-40 ... 125	-40 ... 125	
General data				
Connection method		Spring connection	Soldering and crimp connection	
Stripping length	mm	8	-	
No. of pos.		5	4	
Contact numbering		1 - 5	1 - 4	
Insulation resistance	GΩ	-	≥ 10	
Contact resistance	mΩ	-	-	
Insertion/withdrawal cycles		≥ 500	≥ 500	

Derating curves

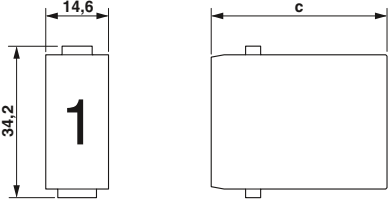

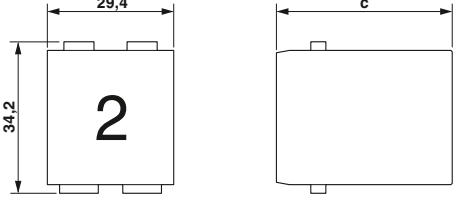
HC-M-05-MOD-...Z

Description	Pos.	Number	Slots	Type	Ordering data		Pcs. / Pkt.	Dimensions (in mm)	
					Socket	Plug			
Spring connection 	5	1 - 5	1	① HC-M-05-MOD-...Z	1647721	1647718	2	 <p>1 module slot</p>	
Coaxial module 	4	1 - 4	1	② HC-M-04-MOD-...	1676789	1676792	2		
Coaxial contacts, 50 Ω 				HC-M-04-...-KOAX-50	1676815	1676802	10	 <p>2 module slots</p>	
Coaxial contacts, 75 Ω 				HC-M-04-...-KOAX-75	1686245	1686258	10		

	a	b	c	d
① Socket			34	
① Plug	14.6		35.5	
② Socket	14.6		32.6	
② Plug			31.5	

Accessories



Hinged retaining frames
From page 566



Crimping tools
From page 637



Removal tool
From page 637



Dummy module
From page 569

Heavy-duty connectors

HEAVYCON B - contact inserts

Modular contact inserts, pneumatic modules

Connection technology:

- Pneumatic contact with valve
- Pneumatic contact without valve

To determine the corresponding housing, see cross-reference list on page 482.

Notes:
For accessories, see from page 634
Only operate connectors when there is no load/the power is switched off
For assembly instructions, see phoenixcontact.net/products



Type	Technical data					
	① HC-M-PN2-MOD-...	② HC-M-PN2-6,00-...-V With valve	③ HC-M-PN2-6,00-... Without valve	④ HC-M-PN3-MOD-...	⑤ ⑥ ⑦ HC-M-PN3-1,60-BU-V With valve	⑧ ⑨ ⑩ HC-M-PN3-1,60-... Without valve
Approvals	ERC	ERC	ERC	ERC	ERC	ERC
Material data for pneumatic module						
Contact carrier material	PC	-	-	PC	-	-
Inflammability class in acc. with UL 94	V0	-	-	V0	-	-
Module slots	1	-	-	1	-	-
Material data for pneumatic contact						
Contact material	-	Delrin acetal	Delrin acetal	-	Delrin acetal	Delrin acetal
Seal material (contact)	-	Buna-N	Buna-N	-	Buna-N	Buna-N
Valve material (contact)	-	Polypropylene	Polypropylene	-	Polypropylene	Polypropylene
Mechanical data						
No. of pos.	2	-	-	3	-	-
Contact numbering	1 - 2	-	-	1 - 3	-	-
Insertion/withdrawal cycles	≥ 500	≥ 500	≥ 500	≥ 500	≥ 500	≥ 500
Internal diameter of pressure hose connection	6 mm	6 mm	6 mm	4 mm	1.6 mm	1.6 mm
Operating pressure	-	8.00 bar	8.00 bar	-	8.00 bar	8.00 bar
Ambient conditions						
Ambient temperature range	°C -40 ... 80	-40 ... 125	-40 ... 125	-40 ... 80	-40 ... 125	-40 ... 125

Description	Pos.	Number	Slots	Ordering data			Pcs. / Pkt.	Dimensions (in mm)																			
				Type	Socket	Plug																					
PN2 pneumatic module 	2	1 - 2	1	① HC-M-PN2-MOD-...	1674998	1674998	2																				
PN2 pneumatic contact 				With valve ② HC-M-PN2-6,00-...-V	1676776		10																				
PN2 pneumatic contact 				Without valve ③ HC-M-PN2-6,00-...	1676763	1676750	10																				
PN3 pneumatic module 	3	1 - 3	1	④ HC-M-PN3-MOD-...	1663475	1663475	2																				
PN3 pneumatic contact 				With valve ⑤ HC-M-PN3-1,60-BU-V	1663543		10	<table border="1"> <thead> <tr> <th></th> <th>a</th> <th>b</th> <th>c</th> <th>d</th> </tr> </thead> <tbody> <tr> <td>① Socket Plug</td> <td>14.6</td> <td></td> <td>27.2</td> <td></td> </tr> <tr> <td>④ Socket Plug</td> <td>14.6</td> <td></td> <td>27.2</td> <td></td> </tr> </tbody> </table>						a	b	c	d	① Socket Plug	14.6		27.2		④ Socket Plug	14.6		27.2	
	a	b	c	d																							
① Socket Plug	14.6		27.2																								
④ Socket Plug	14.6		27.2																								
PN3 pneumatic contact 				With valve ⑥ HC-M-PN3-3,00-BU-V	1663556		10																				
				With valve ⑦ HC-M-PN3-4,00-BU-V	1663569		10																				
				Without valve ⑧ HC-M-PN3-1,60-...	1663514	1663488	10																				
				Without valve ⑨ HC-M-PN3-3,00-...	1663527	1663491	10																				
				Without valve ⑩ HC-M-PN3-4,00-...	1663530	1663501	10																				

Accessories



Hinged retaining frames
From page 566



Dummy module
From page 569

Heavy-duty connectors







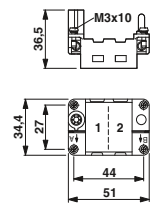

HEAVYCON B - contact inserts

Modular contact inserts, hinged retaining frames

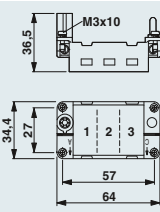
General data		Technical data
Hinged retaining frame material		Die-cast zinc alloy
Connection cross section	[mm ²]	4 mm ² ... 6 mm ² (for PE conductor – power side)
Connection cross section	[mm ²]	1 mm ² ... 2.5 mm ² (for PE conductor – control side)
Connection cross section	AWG	12 ... 10 (for PE conductor – power side)
Connection cross section	AWG	18 ... 14 (for PE conductor – control side)
Insertion/withdrawal cycles		≥ 500
Ambient temperature (operation)		-40 °C ... 125 °C

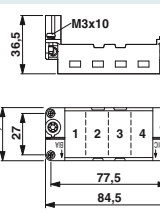

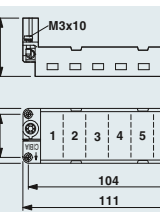
Ordering data

Description	Size	Type	Order No.	Pcs. / Pkt.	Dimensions
Hinged retaining frames¹⁾ 	B6	For sleeve housing (A, B, C, etc.) HC-M-MHR-T2-N	1679249	2	
	B6	For panel mounting base (a, b, c, etc.) HC-M-MHR-A2-N	1679281	2	
Hinged retaining frames¹⁾ 	B10	For sleeve housing (A, B, C, etc.) HC-M-MHR-T3-N	1679252	2	
	B10	For panel mounting base (a, b, c, etc.) HC-M-MHR-A3-N	1679294	2	
Hinged retaining frames¹⁾ 	B16 / B32	For sleeve housing (A, B, C, etc.) HC-M-MHR-T4-N	1679265	2	
	B16 / B32	For panel mounting base (a, b, c, etc.) HC-M-MHR-A4-N	1679304	2	
Hinged retaining frames¹⁾ 	B24/B48	For sleeve housing (A, B, C, etc.) HC-M-MHR-T6-N	1679278	2	
	B24/B48	For panel mounting base (a, b, c, etc.) HC-M-MHR-A6-N	1679317	2	
Fixing wedges 		20 in the block HC-M-MHR-FIX	1585155	2	
Cable lug 		PE extension to 16 mm ² HC-M-MHR-PE16	1636981	50	

Notes:
 For assembly instructions, see phoenixcontact.net/products
¹⁾ For solid conductors and stranded wires with wire end protection

Accessories



Dummy module
From page 569

Modular contact inserts, docking frames

General data		Technical data
Material		PC
Inflammability class in acc. with UL 94		V0
Insertion/withdrawal cycles		≥ 500
Ambient temperature (operation)		-40 °C ... 125 °C
IP degree of protection (when plugged in)		-



Ordering data

Description	Size	Type	Order No.	Pcs. / Pkt.
Docking frame 	B16	Floating (A, B, C, etc.) HC-B 16-ANDOCK-MOD-T	1587454	2
	B16	Fixed (a, b, c, etc.) HC-B 16-ANDOCK-MOD-A	1587467	2
Docking frame 	B24	Floating (A, B, C, etc.) HC-B 24-ANDOCK-MOD-T	1587470	2
	B24	Fixed (a, b, c, etc.) HC-B 24-ANDOCK-MOD-A	1587483	2
Washer, floating 		For M4 cylinder head screws HC-MOD-ANDOCK-USCH	1587496	20

Dimensions

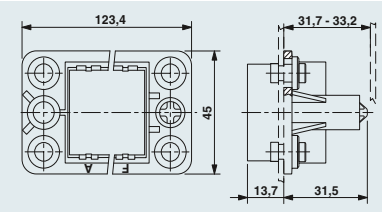
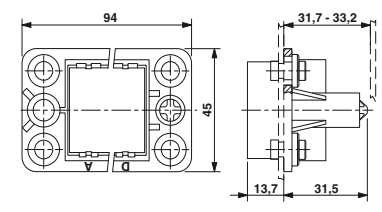

Notes:

- Use of docking frames, e.g., in the back panel of control cabinet racks.
- A metal mounting panel must be grounded separately, as the plastic frame does not have a PE connection.
- Docking frames ensure correct contacting of plug and socket modules

Accessories



Dummy module
From page 569



Metal docking frame
From page 641

Heavy-duty connectors

HEAVYCON B - contact inserts

Modular contact inserts, accessories



General data		Technical data	
Housing material		Polycarbonate	
Lock material		-	
Inflammability class in acc. with UL 94		V0	
External cable diameter		6 mm ... 13 mm	
Ambient temperature (operation)		-40 °C ... 85 °C	
IP degree of protection (when plugged in)		IP65	

Description		Thread	Type	Order No.	Pcs. / Pkt.
Sleeve housing Height: 57.9 mm 		1x M20	For one module, with PE marking HC-MOD-K-TMS-M1M20-G-PE	1408520	2
		1x M20	For one module, without PE marking HC-MOD-K-TMS-M1M20-G-OPE	1408546	2

Dimensions

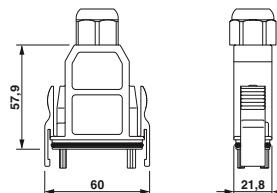

Panel mounting base Height: 22.4 mm 			For one module, without PE marking HC-MOD-K-AFS-PE	1408533	2
			For one module, without PE marking HC-MOD-K-AFS-OPE	1408559	2

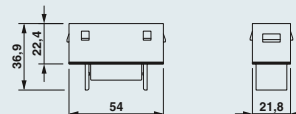

Coding profile 			HC-MOD-K-CP	1408562	1
--	--	--	--------------------	----------------	---

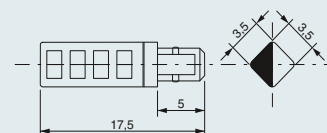

Notes:
For assembly instructions, see phoenixcontact.net/products





Modular contact inserts,
accessories

Technical data

General data	
Material	PC
Inflammability class in acc. with UL 94	-
Ambient temperature (operation)	-40 °C ... 125 °C

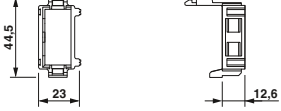

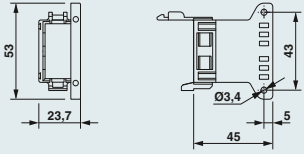
Ordering data

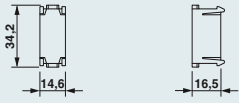
Description	Thread	Type	Order No.	Pcs. / Pkt.	Dimensions
 <p>Contact insert frame</p>		Without strain relief HC-M-MHOZ	1676844	2	
 <p>Contact insert frame</p>		With strain relief HC-M-MHMZ	1676831	2	
 <p>Dummy module</p>		For unused slots HC-M-BM	1676828	2	

Notes:

For assembly instructions, see phoenixcontact.net/products

Heavy-duty connectors

HEAVYCON B - housing

Size B6, plastic, ADVANCE sleeve housing with cable gland

General data

Housing material
Lock material
Sealing material
Ambient temperature (operation)
IP degree of protection (when plugged in)
NEMA degree of protection (when plugged in)

Technical data

Polyamide
Stainless steel
NBR
-40 °C ... 100 °C
IP66 / IP68 (0.2 bar/24 h)
4 / 4X / 6P / 12



Ordering data

Description	Thread	Type	Order No.	Pcs. / Pkt.	Dimensions															
Sleeve housing Height: 93.7 mm 	1x M20 1x M25	Cable outlet: top HC-ADV-B06-HHWH-1TGM20-PL HC-ADV-B06-HHWH-1TGM25-PL	1404222 1404225	1 1																
Sleeve housing Height: 93.7 mm 	1x M20 1x M25	Cable outlet: lateral HC-ADV-B06-HHWH-1SGM20-PL HC-ADV-B06-HHWH-1SGM25-PL	1404224 1404226	1 1																
Panel mounting flange¹⁾ 		2 pcs. per housing HC-B-AF Set with 2 panel mounting flanges HC-B-AF-SET	1686533 1604638	20 1	<table border="1"> <thead> <tr> <th></th> <th>B06</th> <th>B10</th> <th>B16</th> <th>B24</th> </tr> </thead> <tbody> <tr> <td>a</td> <td>70</td> <td>83</td> <td>103</td> <td>130</td> </tr> <tr> <td>b</td> <td>52</td> <td>65</td> <td>86</td> <td>112</td> </tr> </tbody> </table>		B06	B10	B16	B24	a	70	83	103	130	b	52	65	86	112
	B06	B10	B16	B24																
a	70	83	103	130																
b	52	65	86	112																
Protective cover 		For sleeve side, IP50 HC-B 6-TMS-SD-IP50 For panel mounting side, IP66 HC-B 6-TMS-SD-IP66	1690736 1411494	10 10																

Notes:

Marking label: US-EMP (20X9) Order No. [0829439](#)

¹⁾ Bore hole Ø 4.5 mm when using M4 screws, bore hole Ø 3.6 mm when using self-tapping M4 screws (Torx®)

Accessories



Box mounting base
phoenixcontact.net/products



Allen key
See Catalog 5



Replacement seals
From page 651









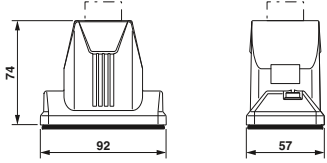

Size B6, metal, ADVANCE sleeve housing, Offshore/EMC

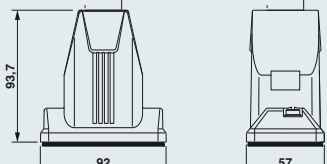

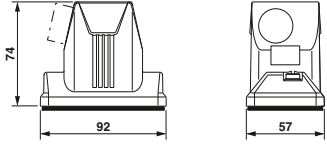
Technical data

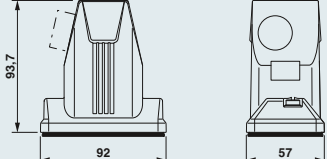
General data	
Housing material	Die-cast aluminum, corrosion resistant
Lock material	Stainless steel
Sealing material	NBR, conductive
Ambient temperature (operation)	-40 °C ... 125 °C
IP degree of protection (when plugged in)	IP66 / IP68 (0.2 bar/24 h) / IP69K (ISO 20653:2013-02)
NEMA degree of protection (when plugged in)	4 / 4X / 6P / 12

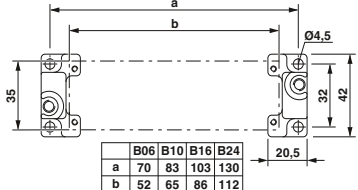
Ordering data

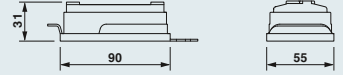
Description	Thread	Type	Order No.	Pcs. / Pkt.	Dimensions															
Sleeve housing¹⁾ Height: 74 mm 	1x M20 1x M25	Cable outlet: top	HC-ADV-B06-HLWH-1TTM20-EMC-AL	1413362																
		HC-ADV-B06-HLWH-1TTM25-EMC-AL	1413364	1																
Sleeve housing¹⁾ Height: 93.7 mm 	1x M25 1x M32	Cable outlet: top	HC-ADV-B06-HHWH-1TTM25-EMC-AL	1413374																
		HC-ADV-B06-HHWH-1TTM32-EMC-AL	1413376	1																
Sleeve housing¹⁾ Height: 74 mm 	1x M20 1x M25	Cable outlet: lateral	HC-ADV-B06-HLWH-1STM20-EMC-AL	1413363																
		HC-ADV-B06-HLWH-1STM25-EMC-AL	1413365	1																
Sleeve housing¹⁾ Height: 93.7 mm 	1x M25 1x M32	Cable outlet: lateral	HC-ADV-B06-HHWH-1STM25-EMC-AL	1413375																
		HC-ADV-B06-HHWH-1STM32-EMC-AL	1413377	1																
Panel mounting flange²⁾ 		2 pcs. per housing	HC-B-AF	1686533	 <table border="1" data-bbox="1189 1533 1348 1585"> <tr> <td></td> <td>B06</td> <td>B10</td> <td>B16</td> <td>B24</td> </tr> <tr> <td>a</td> <td>70</td> <td>83</td> <td>103</td> <td>130</td> </tr> <tr> <td>b</td> <td>52</td> <td>65</td> <td>86</td> <td>112</td> </tr> </table>		B06	B10	B16	B24	a	70	83	103	130	b	52	65	86	112
		B06	B10	B16		B24														
a	70	83	103	130																
b	52	65	86	112																
HC-B-AF-SET	1604638	1																		
Protective cover 		For sleeve side, IP50	HC-B 6-TMS-SD-IP50	1690736																
	For panel mounting side, IP66	HC-B 6-TMS-SD-IP66	1411494	10																

Notes:

In order to achieve optimum shielding results, the mounting surface must be conductive

Marking label: US-EMLP-HA (20X9), Order No. 0830989

¹⁾ Screw locking with M6 Allen screws

²⁾ Bore hole \varnothing 4.5 mm when using M4 screws, bore hole \varnothing 3.6 mm when using self-tapping M4 screws (Torx[®])

Accessories



Cable glands
From page 680



Box mounting base
phoenixcontact.net/products



Allen key
See Catalog 5



Replacement seals
From page 651

Heavy-duty connectors

HEAVYCON B - housing

Size B6, plastic, EVO housing, single locking latch

General data









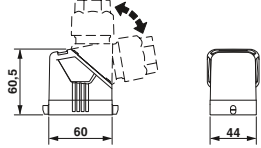

Housing material	Polyamide
Locking latch material	Polyamide
Sealing material	NBR
Ambient temperature (operation)	-40 °C ... 125 °C
IP degree of protection (when plugged in)	IP66
NEMA degree of protection (when plugged in)	4 / 4X / 12

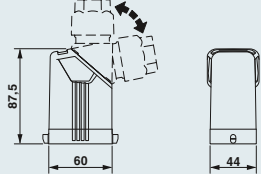
Technical data

Housing material	Polyamide
Locking latch material	Polyamide
Sealing material	NBR
Ambient temperature (operation)	-40 °C ... 125 °C
IP degree of protection (when plugged in)	IP66
NEMA degree of protection (when plugged in)	4 / 4X / 12

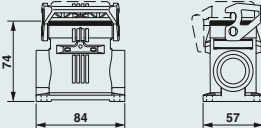

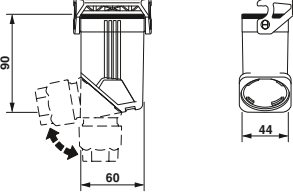
Ordering data

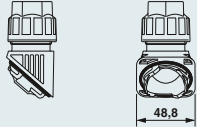
Description	Thread	Type	Order No.	Pcs. / Pkt.	Dimensions
Sleeve housing Height: 60.5 mm 		HC-EVO-B06-HLFS-PLBK	1407619	1	
Sleeve housing Height: 87.5 mm 		HC-EVO-B06-HHFS-PLBK	1407620	1	
Panel mounting base Height: 30.5 mm 		Without cover HC-EVO-B06-BWS-PLRBK	1407621	1	
		With cover HC-EVO-B06-BWSC-PLRBK	1407622	1	
Box mounting base ¹⁾ Height: 74 mm 	2x M32	Without cover HC-EVO-B06-SHWS-2SSM32-PLRBK	1407623	1	
	2x M32	With cover HC-EVO-B06-SHWSC-2SSM32-PLRBK	1407624	1	
Coupling housing Height: 90 mm 		HC-EVO-B06-CHWS-PLRBK	1407625	1	
Cable gland 	Clamping area 7 mm ... 13 mm 9 mm ... 17 mm 11 mm ... 21 mm 19 mm ... 28 mm	HC-B-G-M20-PLRBK	1407669	1	
		HC-B-G-M25-PLRBK	1407670	1	
		HC-B-G-M32-PLRBK	1407671	1	
		HC-B-G-M40-PLRBK	1407672	1	

Notes:

For further accessories, see page 642

Marking label: US-EMP (20X9) Order No. 0829439

¹⁾ One cable entry is sealed with a knockout cover

Accessories



EVO unlocking
From page 653



Thread adapter
From page 643



Replacement seals
From page 650



Connector set
From page 622

Size B6, metal, EVO housing, single locking latch



Technical data

General data	
Housing material	Die-cast aluminum, corrosion resistant
Locking latch material	Polyamide
Sealing material	NBR, conductive
Ambient temperature (operation)	-40 °C ... 125 °C
IP degree of protection (when plugged in)	IP66 / IP69K (ISO 20653:2013-02)
NEMA degree of protection (when plugged in)	4 / 4X / 12

Ordering data

Description	Thread	Type	Order No.	Pcs. / Pkt.	Dimensions
Sleeve housing Height: 60.5 mm		HC-EVO-B06-HLFS-EL-AL	1411448	1	
Sleeve housing Height: 80 mm		HC-EVO-B06-HHFS-EL-AL	1411447	1	
Panel mounting base Height: 30.5 mm		Without cover HC-STA-B06-BWS-ELC-AL	1411318	1	
		With cover HC-STA-B06-BWSC-ELC-AL	1411319	1	
Box mounting base¹⁾ Height: 54.6 mm	2x M20 2x M25 2x Pg16	Without cover HC-STA-B06-SLWS-2SSM20-ELC-AL	1412821	1	
		HC-STA-B06-SLWS-2SSM25-ELC-AL	1412822	1	
		HC-STA-B06-SLWS-2SSP16-ELC-AL	1412823	1	
	2x M20 2x M25 2x Pg16	With cover HC-STA-B06-SLWSC-2SSM20-ELC-AL	1412825	1	
		HC-STA-B06-SLWSC-2SSM25-ELC-AL	1412826	1	
		HC-STA-B06-SLWSC-2SSP16-ELC-AL	1412827	1	
Coupling housing Height: 82 mm		HC-EVO-B06-CHWS-ELC-AL	1411450	1	
Cable gland	Clamping area 7 mm ... 13 mm 11 mm ... 16 mm 14 mm ... 21 mm 19 mm ... 27 mm	HC-B-G-M20-ER-AL	1411442	1	
		HC-B-G-M25-ER-AL	1411443	1	
		HC-B-G-M32-ER-AL	1411444	1	
		HC-B-G-M40-ER-AL	1411445	1	

Notes:

- For further accessories, see page 642
- Marking label: US-EMLP-HA (20X9), Order No. 0830989
- ¹⁾ Supplied with a plastic sealing cap

Accessories



Thread adapter
From page 643



EMC cable gland
From page 642



Replacement seals
From page 650



Connector set
From page 623

Heavy-duty connectors

HEAVYCON B - housing

Size B6, metal, STANDARD sleeve housing for single locking latch

new



General data

Housing material
Locking latch material
Sealing material
Ambient temperature (operation)
IP degree of protection (when plugged in)
NEMA degree of protection (when plugged in)

Technical data
Die-cast aluminum, corrosion resistant
-
-
-40 °C ... 125 °C
IP66 / IP69K (ISO 20653:2013-02)
4 / 4X / 12

Ordering data

Description	Thread	Type	Order No.	Pcs. / Pkt.	Dimensions
Sleeve housing Height: 52 mm 	1x M20 1x M25	Cable outlet: top HC-STA-B06-HLFS-1TTM20-EL-AL	1412574	1	
		HC-STA-B06-HLFS-1TTM25-EL-AL	1412575	1	
	1x Pg13.5 1x Pg16	HC-STA-B06-HLFS-1TTP13-EL-AL	1412576	1	
		HC-STA-B06-HLFS-1TTP16-EL-AL	1412577	1	
Sleeve housing Height: 72 mm 	1x M25 1x M32	Cable outlet: top HC-STA-B06-HHFS-1TTM25-EL-AL	1412566	1	
		HC-STA-B06-HHFS-1TTM32-EL-AL	1412567	1	
	1x Pg21 1x Pg29	HC-STA-B06-HHFS-1TTP21-EL-AL	1412568	1	
		HC-STA-B06-HHFS-1TTP29-EL-AL	1412569	1	
Sleeve housing Height: 52 mm 	1x M20 1x M25	Cable outlet: lateral HC-STA-B06-HLFS-1STM20-EL-AL	1412570	1	
		HC-STA-B06-HLFS-1STM25-EL-AL	1412571	1	
	1x Pg13.5 1x Pg16	HC-STA-B06-HLFS-1STP13-EL-AL	1412572	1	
		HC-STA-B06-HLFS-1STP16-EL-AL	1412573	1	
Sleeve housing Height: 72 mm 	1x M25 1x M32	Cable outlet: lateral HC-STA-B06-HHFS-1STM25-EL-AL	1412562	1	
		HC-STA-B06-HHFS-1STM32-EL-AL	1412563	1	
	1x Pg21 1x Pg29	HC-STA-B06-HHFS-1STP21-EL-AL	1412564	1	
		HC-STA-B06-HHFS-1STP29-EL-AL	1412565	1	

Notes:
For further accessories, see page 642
Marking label: US-EMLP-HA (20X9), Order No. 0830989

Accessories

 Cable glands From page 680	 Protective cover From page 646	 Cover plates From page 648	 Connector set From page 624
---	---	---	--







Size B6, metal, STANDARD supporting base element with single locking latch

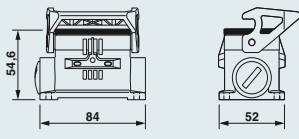

Technical data

General data	
Housing material	Die-cast aluminum, corrosion resistant
Locking latch material	Polyamide
Sealing material	NBR, conductive
Ambient temperature (operation)	-40 °C ... 125 °C
IP degree of protection (when plugged in)	IP66 / IP69K (ISO 20653:2013-02)
NEMA degree of protection (when plugged in)	4 / 4X / 12

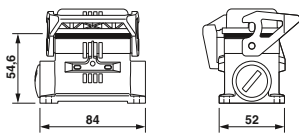
Ordering data

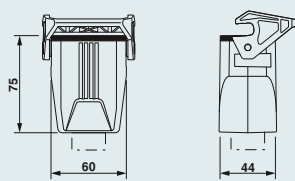
Description	Thread	Type	Order No.	Pcs. / Pkt.	Dimensions
Panel mounting base Height: 30.5 mm 		Without cover HC-STA-B06-BWS-ELC-AL	1411318	1	
		With cover HC-STA-B06-BWSC-ELC-AL	1411319	1	
Box mounting base¹⁾ Height: 54.6 mm 	2x M20 2x M25 2x Pg16	Without cover HC-STA-B06-SLWS-2SSM20-ELC-AL	1412821	1	
		HC-STA-B06-SLWS-2SSM25-ELC-AL	1412822	1	
		HC-STA-B06-SLWS-2SSP16-ELC-AL	1412823	1	
Box mounting base¹⁾ Height: 54.6 mm 	2x M20 2x M25 2x Pg16	With cover HC-STA-B06-SLWSC-2SSM20-ELC-AL	1412825	1	
		HC-STA-B06-SLWSC-2SSM25-ELC-AL	1412826	1	
		HC-STA-B06-SLWSC-2SSP16-ELC-AL	1412827	1	
Coupling housing Height: 73 mm 	1x M20 1x M25 1x M32 1x Pg13.5 1x Pg21 1x Pg29	Cable outlet: top HC-STA-B06-CHWS-1TTM20-ELC-AL	1412555	1	
		HC-STA-B06-CHWS-1TTM25-ELC-AL	1412556	1	
		HC-STA-B06-CHWS-1TTM32-ELC-AL	1412557	1	
		HC-STA-B06-CHWS-1TTP13-ELC-AL	1412558	1	
		HC-STA-B06-CHWS-1TTP21-ELC-AL	1412559	1	
		HC-STA-B06-CHWS-1TTP29-ELC-AL	1412560	1	

Notes:

- For further accessories, see page 642
- ¹⁾ Supplied with a plastic sealing cap

Accessories



Cable glands
From page 680



Replacement seals
From page 651



Replacement protective cover
From page 647



Replacement latch
From page 652

Heavy-duty connectors

HEAVYCON B - housing

Size B10, plastic, ADVANCE sleeve housing with cable gland







General data

Housing material
Lock material
Sealing material
Ambient temperature (operation)
IP degree of protection (when plugged in)
NEMA degree of protection (when plugged in)

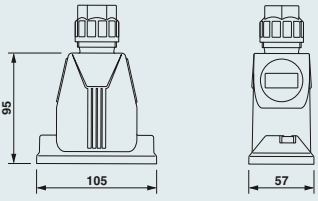
Technical data	
Housing material	Polyamide
Lock material	Stainless steel
Sealing material	NBR
Ambient temperature (operation)	-40 °C ... 100 °C
IP degree of protection (when plugged in)	IP66 / IP68 (0.2 bar/24 h)
NEMA degree of protection (when plugged in)	4 / 4X / 6P / 12

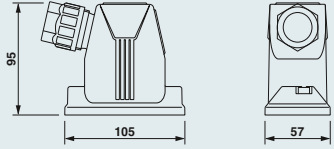

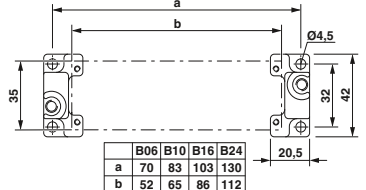
Ordering data		
Description	Thread	Type

Description	Thread	Type	Order No.	Pcs. / Pkt.	Dimensions															
Sleeve housing Height: 95 mm 	1x M25 1x M32	Cable outlet: top HC-ADV-B10-HHWH-1TGM25-PL HC-ADV-B10-HHWH-1TGM32-PL	1404227 1404229	1 1																
Sleeve housing Height: 95 mm 	1x M25 1x M32	Cable outlet: lateral HC-ADV-B10-HHWH-1SGM25-PL HC-ADV-B10-HHWH-1SGM32-PL	1404228 1404230	1 1																
Panel mounting flange¹⁾ 		2 pcs. per housing HC-B-AF Set with 2 panel mounting flanges HC-B-AF-SET	1686533 1604638	20 1	 <table border="1" data-bbox="1204 1533 1356 1585"> <thead> <tr> <th></th> <th>B06</th> <th>B10</th> <th>B16</th> <th>B24</th> </tr> </thead> <tbody> <tr> <td>a</td> <td>70</td> <td>83</td> <td>103</td> <td>130</td> </tr> <tr> <td>b</td> <td>52</td> <td>65</td> <td>86</td> <td>112</td> </tr> </tbody> </table>		B06	B10	B16	B24	a	70	83	103	130	b	52	65	86	112
	B06	B10	B16	B24																
a	70	83	103	130																
b	52	65	86	112																
Protective cover 		For sleeve side, IP50 HC-B 10-TMS-SD-IP50 For panel mounting side, IP66 HC-B 10-TMS-SD-IP66	1690749 1411504	10 10																

Notes:
 Marking label: US-EMP (20X9) Order No. 0829439
¹⁾ Bore hole Ø 4.5 mm when using M4 screws, bore hole Ø 3.6 mm when using self-tapping M4 screws (Torx®)

Accessories

 Box mounting base phoenixcontact.net/products	 Allen key See Catalog 5	 Replacement seals From page 651
---	--	--











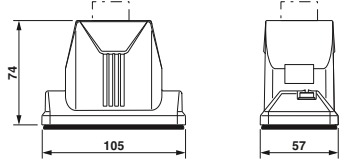

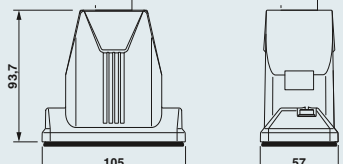
Size B10, metal, ADVANCE sleeve housing, Offshore/EMC

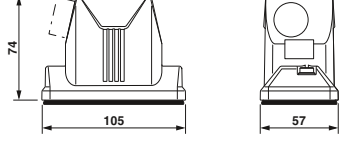
Technical data

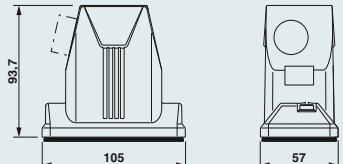
General data	
Housing material	Die-cast aluminum, corrosion resistant
Lock material	Stainless steel
Sealing material	NBR, conductive
Ambient temperature (operation)	-40 °C ... 125 °C
IP degree of protection (when plugged in)	IP66 / IP68 (0.2 bar/24 h) / IP69K (ISO 20653:2013-02)
NEMA degree of protection (when plugged in)	4 / 4X / 6P / 12

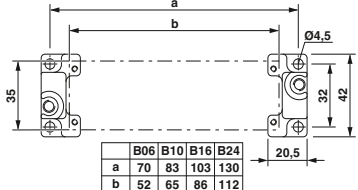
Ordering data

Description	Thread	Type	Order No.	Pcs. / Pkt.	Dimensions															
Sleeve housing¹⁾ Height: 74 mm 	1x M20 1x M25	Cable outlet: top	HC-ADV-B10-HLWH-1TTM20-EMC-AL	1413388																
			HC-ADV-B10-HLWH-1TTM25-EMC-AL	1413390																
Sleeve housing¹⁾ Height: 93.7 mm 	1x M25 1x M32	Cable outlet: top	HC-ADV-B10-HHWH-1TTM25-EMC-AL	1413400																
			HC-ADV-B10-HHWH-1TTM32-EMC-AL	1413402																
Sleeve housing¹⁾ Height: 74 mm 	1x M20 1x M25	Cable outlet: lateral	HC-ADV-B10-HLWH-1STM20-EMC-AL	1413389																
			HC-ADV-B10-HLWH-1STM25-EMC-AL	1413391																
Sleeve housing¹⁾ Height: 93.7 mm 	1x M25 1x M32	Cable outlet: lateral	HC-ADV-B10-HHWH-1STM25-EMC-AL	1413401																
			HC-ADV-B10-HHWH-1STM32-EMC-AL	1413403																
Panel mounting flange²⁾ 		2 pcs. per housing	HC-B-AF	1686533	 <table border="1" style="margin-top: 10px;"> <thead> <tr> <th></th> <th>B06</th> <th>B10</th> <th>B16</th> <th>B24</th> </tr> </thead> <tbody> <tr> <td>a</td> <td>70</td> <td>83</td> <td>103</td> <td>130</td> </tr> <tr> <td>b</td> <td>52</td> <td>65</td> <td>86</td> <td>112</td> </tr> </tbody> </table>		B06	B10	B16	B24	a	70	83	103	130	b	52	65	86	112
		B06	B10	B16		B24														
a	70	83	103	130																
b	52	65	86	112																
		Set with 2 panel mounting flanges	HC-B-AF-SET	1604638																
Protective cover 		For sleeve side, IP50	HC-B 10-TMS-SD-IP50	1690749																
		For panel mounting side, IP66	HC-B 10-TMS-SD-IP66	1411504																

Notes:

In order to achieve optimum shielding results, the mounting surface must be conductive

Marking label: US-EMLP-HA (20X9), Order No. 0830989

¹⁾ Screw locking with M6 Allen screws

²⁾ Bore hole \varnothing 4.5 mm when using M4 screws, bore hole \varnothing 3.6 mm when using self-tapping M4 screws (Torx®)

Accessories



Screw connections
From page 680



Box mounting base
phoenixcontact.net/products



Allen key
See Catalog 5



Replacement seals
From page 651

Heavy-duty connectors

HEAVYCON B - housing

Size B10, plastic, EVO housing, single locking latch

General data



Housing material	Polyamide
Locking latch material	Polyamide
Sealing material	NBR
Ambient temperature (operation)	-40 °C ... 125 °C
IP degree of protection (when plugged in)	IP66
NEMA degree of protection (when plugged in)	4 / 4X / 12

Technical data

Housing material	Polyamide
Locking latch material	Polyamide
Sealing material	NBR
Ambient temperature (operation)	-40 °C ... 125 °C
IP degree of protection (when plugged in)	IP66
NEMA degree of protection (when plugged in)	4 / 4X / 12

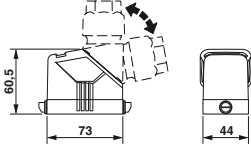

Ordering data

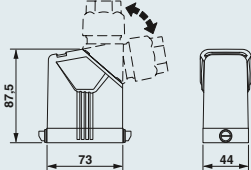
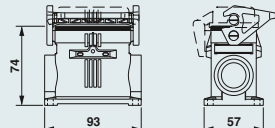
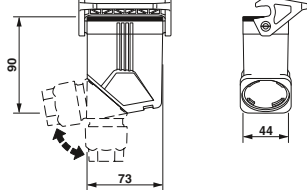
Description	Thread	Type	Order No.	Pcs. / Pkt.	Dimensions
Sleeve housing Height: 60.5 mm 		HC-EVO-B10-HLFS-PLBK	1407626	1	
Sleeve housing Height: 87.5 mm 		HC-EVO-B10-HHFS-PLBK	1407627	1	
Panel mounting base Height: 30.5 mm 		Without cover HC-EVO-B10-BWS-PLRBK	1407632	1	
		With cover HC-EVO-B10-BWSC-PLRBK	1407633	1	
Box mounting base ¹⁾ Height: 74 mm 	2x M32	Without cover HC-EVO-B10-SHWS-2SSM32-PLRBK	1407636	1	
	2x M32	With cover HC-EVO-B10-SHWSC-2SSM32-PLRBK	1407637	1	
Coupling housing Height: 90 mm 		HC-EVO-B10-CHWS-PLRBK	1407640	1	
Cable gland 	Clamping area 7 mm ... 13 mm 9 mm ... 17 mm 11 mm ... 21 mm 19 mm ... 28 mm	HC-B-G-M20-PLRBK	1407669	1	
		HC-B-G-M25-PLRBK	1407670	1	
		HC-B-G-M32-PLRBK	1407671	1	
		HC-B-G-M40-PLRBK	1407672	1	

Notes:

For further accessories, see page 642

Marking label: US-EMP (20X9) Order No. 0829439

¹⁾ One cable entry is sealed with a knockout cover

Accessories



EVO unlocking
From page 653



Thread adapter
From page 643



Replacement seals
From page 650



Connector set
From page 622

Size B10, metal, EVO housing, single locking latch



General data	
Housing material	Die-cast aluminum, corrosion resistant
Locking latch material	Polyamide
Sealing material	NBR, conductive
Ambient temperature (operation)	-40 °C ... 125 °C
IP degree of protection (when plugged in)	IP66 / IP69K (ISO 20653:2013-02)
NEMA degree of protection (when plugged in)	4 / 4X / 12

Technical data	
Housing material	Die-cast aluminum, corrosion resistant
Locking latch material	Polyamide
Sealing material	NBR, conductive
Ambient temperature (operation)	-40 °C ... 125 °C
IP degree of protection (when plugged in)	IP66 / IP69K (ISO 20653:2013-02)
NEMA degree of protection (when plugged in)	4 / 4X / 12

Description		Thread	Type	Order No.	Pcs. / Pkt.	Dimensions
Sleeve housing Height: 64 mm			HC-EVO-B10-HLFS-EL-AL	1411456	1	
Sleeve housing Height: 80 mm			HC-EVO-B10-HHFS-EL-AL	1411453	1	
Panel mounting base Height: 30.5 mm			Without cover HC-STA-B10-BWS-ELC-AL With cover HC-STA-B10-BWSC-ELC-AL	1411320 1411321	1 1	
Box mounting base ¹⁾ Height: 54.6 mm		2x M20 2x M25 2x Pg16	Without cover HC-STA-B10-SLWS-2SSM20-ELC-AL HC-STA-B10-SLWS-2SSM25-ELC-AL HC-STA-B10-SLWS-2SSP16-ELC-AL With cover HC-STA-B10-SLWSC-2SSM20-ELC-AL HC-STA-B10-SLWSC-2SSM25-ELC-AL HC-STA-B10-SLWSC-2SSP16-ELC-AL	1412839 1412840 1412842 1412844 1412845 1412846	1 1 1 1 1 1	
Coupling housing Height: 83 mm			HC-EVO-B10-CHWS-ELC-AL	1411459	1	
Cable gland		Clamping area 7 mm ... 13 mm 11 mm ... 16 mm 14 mm ... 21 mm 19 mm ... 27 mm	HC-B-G-M20-ER-AL HC-B-G-M25-ER-AL HC-B-G-M32-ER-AL HC-B-G-M40-ER-AL	1411442 1411443 1411444 1411445	1 1 1 1	

Notes:	
Marking label: US-EMLP-HA (20X9), Order No. 0830989	
¹⁾ Supplied with a plastic sealing cap	

Ordering data		
Type	Order No.	Pcs. / Pkt.

Accessories

Thread adapter From page 643	EMC cable gland From page 642	Replacement seals From page 650	Connector set From page 623

Heavy-duty connectors

HEAVYCON B - housing

Size B10, metal, STANDARD sleeve housing for single locking latch

new







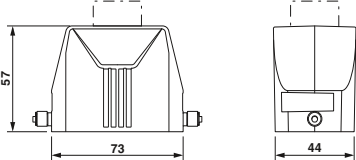

General data

Housing material
Locking latch material
Sealing material
Ambient temperature (operation)
IP degree of protection (when plugged in)
NEMA degree of protection (when plugged in)

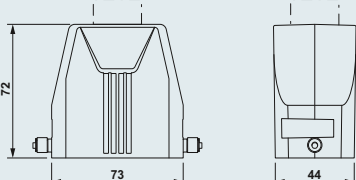
Technical data
Die-cast aluminum, corrosion resistant
-
-
-40 °C ... 125 °C
IP66 / IP69K (ISO 20653:2013-02)
4 / 4X / 12

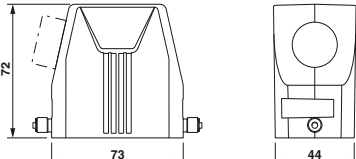
Ordering data

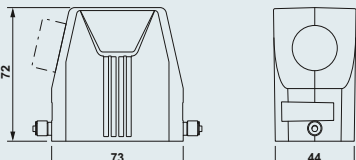
Description	Thread	Type	Order No.	Pcs. / Pkt.	Dimensions
Sleeve housing Height: 57 mm 	1x M20 1x M25	Cable outlet: top HC-STA-B10-HLFS-1TTM20-EL-AL	1412629	1	
		HC-STA-B10-HLFS-1TTM25-EL-AL	1412630	1	
	1x Pg16 1x Pg21	HC-STA-B10-HLFS-1TTP16-EL-AL	1412631	1	
		HC-STA-B10-HLFS-1TTP21-EL-AL	1412632	1	
Sleeve housing Height: 72 mm 	1x M25 1x M32	Cable outlet: top HC-STA-B10-HHFS-1TTM25-EL-AL	1412604	1	
		HC-STA-B10-HHFS-1TTM32-EL-AL	1412605	1	
	1x Pg21 1x Pg29	HC-STA-B10-HHFS-1TTP21-EL-AL	1412606	1	
		HC-STA-B10-HHFS-1TTP29-EL-AL	1412607	1	
Sleeve housing Height: 57 mm 	1x M20 1x M25	Cable outlet: lateral HC-STA-B10-HLFS-1STM20-EL-AL	1412624	1	
		HC-STA-B10-HLFS-1STM25-EL-AL	1412625	1	
	1x Pg16 1x Pg21	HC-STA-B10-HLFS-1STP16-EL-AL	1412627	1	
		HC-STA-B10-HLFS-1STP21-EL-AL	1412628	1	
Sleeve housing Height: 72 mm 	1x M25 1x M32	Cable outlet: lateral HC-STA-B10-HHFS-1STM25-EL-AL	1412600	1	
		HC-STA-B10-HHFS-1STM32-EL-AL	1412601	1	
	1x Pg21 1x Pg29	HC-STA-B10-HHFS-1STP21-EL-AL	1412602	1	
		HC-STA-B10-HHFS-1STP29-EL-AL	1412603	1	

Notes:
 For further accessories, see page 642
 Marking label: US-EMLP-HA (20X9), Order No. 0830989

Accessories

 Cable glands From page 680	 Protective cover From page 646	 Cover plates From page 648	 Connector set From page 624
---	---	---	--

new







Size B10, metal, STANDARD supporting base element with single locking latch

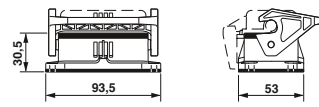

Technical data

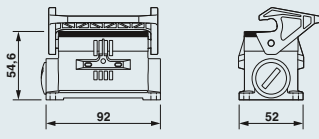
General data	
Housing material	Die-cast aluminum, corrosion resistant
Locking latch material	Polyamide
Sealing material	NBR, conductive
Ambient temperature (operation)	-40 °C ... 125 °C
IP degree of protection (when plugged in)	IP66 / IP69K (ISO 20653:2013-02)
NEMA degree of protection (when plugged in)	4 / 4X / 12

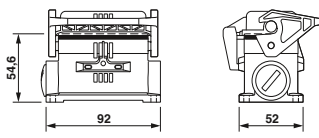
Ordering data

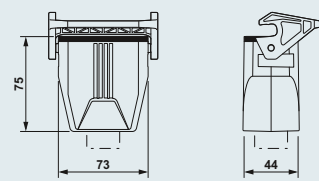
Description	Thread	Type	Order No.	Pcs. / Pkt.	Dimensions
Panel mounting base Height: 30.5 mm 		Without cover HC-STA-B10-BWS-ELC-AL	1411320	1	
		With cover HC-STA-B10-BWSC-ELC-AL	1411321	1	
Box mounting base¹⁾ Height: 54.6 mm 	2x M20 2x M25 2x Pg16	Without cover HC-STA-B10-SLWS-2SSM20-ELC-AL	1412839	1	
		HC-STA-B10-SLWS-2SSM25-ELC-AL	1412840	1	
		HC-STA-B10-SLWS-2SSP16-ELC-AL	1412842	1	
Box mounting base¹⁾ Height: 54.6 mm 	2x M20 2x M25 2x Pg16	With cover HC-STA-B10-SLWSC-2SSM20-ELC-AL	1412844	1	
		HC-STA-B10-SLWSC-2SSM25-ELC-AL	1412845	1	
		HC-STA-B10-SLWSC-2SSP16-ELC-AL	1412846	1	
Coupling housing Height: 73 mm 	1x M20 1x M25 1x M32 1x Pg16 1x Pg21 1x Pg29	Cable outlet: top HC-STA-B10-CHWS-1TTM20-ELC-AL	1412584	1	
		HC-STA-B10-CHWS-1TTM25-ELC-AL	1412585	1	
		HC-STA-B10-CHWS-1TTM32-ELC-AL	1412586	1	
		HC-STA-B10-CHWS-1TTP16-ELC-AL	1412587	1	
		HC-STA-B10-CHWS-1TTP21-ELC-AL	1412588	1	
		HC-STA-B10-CHWS-1TTP29-ELC-AL	1412589	1	

Notes:

For further accessories, see page 642

¹⁾ Supplied with a plastic sealing cap

Accessories



Cable glands
From page 680



Replacement seals
From page 651



Replacement protective cover
From page 647



Replacement latch
From page 652

Heavy-duty connectors

HEAVYCON B - housing

Size B10, plastic, EVO housing, double locking latch

General data









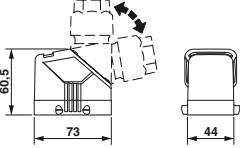

Housing material	Polyamide
Locking latch material	Polyamide
Sealing material	NBR
Ambient temperature (operation)	-40 °C ... 125 °C
IP degree of protection (when plugged in)	IP66
NEMA degree of protection (when plugged in)	4 / 4X / 12

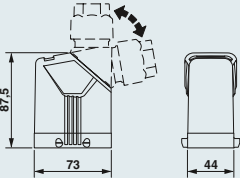
Technical data

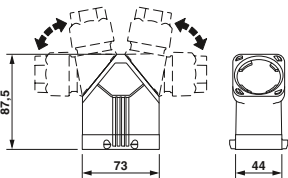
Housing material	Polyamide
Locking latch material	Polyamide
Sealing material	NBR
Ambient temperature (operation)	-40 °C ... 125 °C
IP degree of protection (when plugged in)	IP66
NEMA degree of protection (when plugged in)	4 / 4X / 12

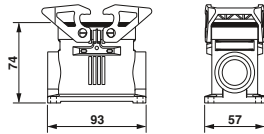

Ordering data

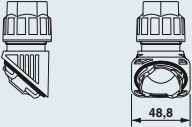
Description	Thread	Type	Order No.	Pcs. / Pkt.	Dimensions
Sleeve housing Height: 60.5 mm 		HC-EVO-B10-HLFD-PLBK	1407628	1	
Sleeve housing Height: 87.5 mm 		HC-EVO-B10-HHFD-PLBK	1407629	1	
Double sleeve housing Height: 87.5 mm 		HC-EVO-B10-HHFD-2B-PL-BK	1411495	1	
Panel mounting base Height: 30.5 mm 		Without cover HC-EVO-B10-BWD-PLRBK	1407634	1	
Box mounting base¹⁾ Height: 74 mm 	2x M32	Without cover HC-EVO-B10-SHWD-2SSM32-PLRBK	1407638	1	
Cable gland 	Clamping area 7 mm ... 13 mm 9 mm ... 17 mm 11 mm ... 21 mm 19 mm ... 28 mm	HC-B-G-M20-PLRBK HC-B-G-M25-PLRBK HC-B-G-M32-PLRBK HC-B-G-M40-PLRBK	1407669 1407670 1407671 1407672	1 1 1 1	

Notes:

For further accessories, see page 642

Marking label: US-EMP (20X9) Order No. 0829439

¹⁾ One cable entry is sealed with a knockout cover

Accessories



EVO unlocking
From page 653



Thread adapter
From page 643



Replacement seals
From page 650











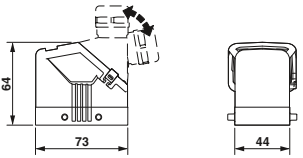

Connector set
From page 622

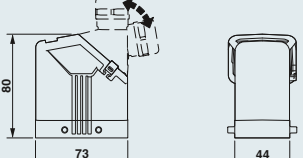
Size B10, metal, EVO housing, double locking latch

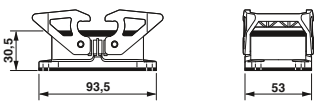

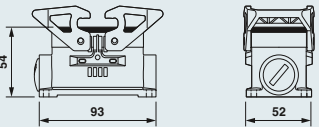
General data	
Housing material	Die-cast aluminum, corrosion resistant
Locking latch material	Polyamide
Sealing material	NBR, conductive
Ambient temperature (operation)	-40 °C ... 125 °C
IP degree of protection (when plugged in)	IP66 / IP69K (ISO 20653:2013-02)
NEMA degree of protection (when plugged in)	4 / 4X / 12

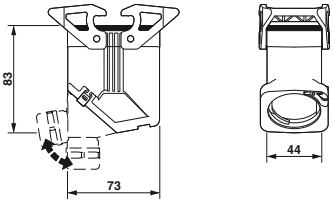
Technical data	
Housing material	Die-cast aluminum, corrosion resistant
Locking latch material	Polyamide
Sealing material	NBR, conductive
Ambient temperature (operation)	-40 °C ... 125 °C
IP degree of protection (when plugged in)	IP66 / IP69K (ISO 20653:2013-02)
NEMA degree of protection (when plugged in)	4 / 4X / 12

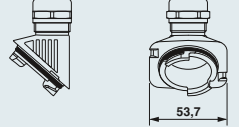
Description		Thread	Type	Order No.	Pcs. / Pkt.	Dimensions
Sleeve housing Height: 64 mm 			HC-EVO-B10-HLFD-EL-AL	1411455	1	
Sleeve housing Height: 80 mm 			HC-EVO-B10-HHFD-EL-AL	1411451	1	
Panel mounting base Height: 30.5 mm 			Without cover HC-STA-B10-BWD-ELC-AL	1411322	1	
Box mounting base¹⁾ Height: 54 mm 		2x M20 2x M25 2x Pg16	Without cover HC-STA-B10-SLWD-2SSM20-ELC-AL HC-STA-B10-SLWD-2SSM25-ELC-AL HC-STA-B10-SLWD-2SSP16-ELC-AL	1412835 1412836 1412837	1 1 1	
Coupling housing Height: 83 mm 			HC-EVO-B10-CHWD-ELC-AL	1411458	1	
Cable gland 		Clamping area 7 mm ... 13 mm 11 mm ... 16 mm 14 mm ... 21 mm 19 mm ... 27 mm	HC-B-G-M20-ER-AL HC-B-G-M25-ER-AL HC-B-G-M32-ER-AL HC-B-G-M40-ER-AL	1411442 1411443 1411444 1411445	1 1 1 1	

Notes:	
For further accessories, see page 642	
Marking label: US-EMLP-HA (20X9), Order No. 0830989	
¹⁾ Supplied with a plastic sealing cap	

Accessories

 Thread adapter From page 643	 EMC cable gland From page 642	 Replacement seals From page 650	 Connector set From page 623
---	--	--	--

Heavy-duty connectors

HEAVYCON B - housing

Size B10, metal, STANDARD sleeve housing for double locking latch

new







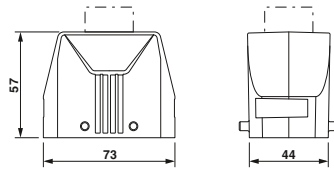

General data

Housing material
Locking latch material
Sealing material
Ambient temperature (operation)
IP degree of protection (when plugged in)
NEMA degree of protection (when plugged in)

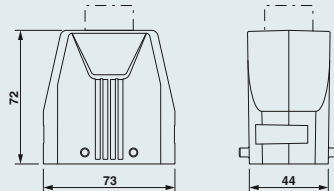
Technical data
Die-cast aluminum, corrosion resistant
-
-
-40 °C ... 125 °C
IP66 / IP69K (ISO 20653:2013-02)
4 / 4X / 12

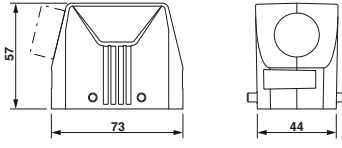
Ordering data

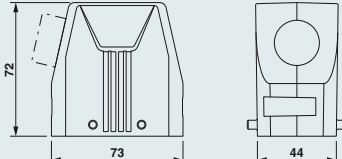
Description	Thread	Type	Order No.	Pcs. / Pkt.	Dimensions
Sleeve housing Height: 57 mm 	1x M20 1x M25	Cable outlet: top HC-STA-B10-HLFD-1TTM20-EL-AL	1412620	1	
		HC-STA-B10-HLFD-1TTM25-EL-AL	1412621	1	
	1x Pg16 1x Pg21	HC-STA-B10-HLFD-1TTP16-EL-AL	1412622	1	
		HC-STA-B10-HLFD-1TTP21-EL-AL	1412623	1	
Sleeve housing Height: 72 mm 	1x M25 1x M32	Cable outlet: top HC-STA-B10-HHFD-1TTM25-EL-AL	1412596	1	
		HC-STA-B10-HHFD-1TTM32-EL-AL	1412597	1	
	1x Pg21 1x Pg29	HC-STA-B10-HHFD-1TTP21-EL-AL	1412598	1	
		HC-STA-B10-HHFD-1TTP29-EL-AL	1412599	1	
Sleeve housing Height: 57 mm 	1x M20 1x M25	Cable outlet: lateral HC-STA-B10-HLFD-1STM20-EL-AL	1412616	1	
		HC-STA-B10-HLFD-1STM25-EL-AL	1412617	1	
	1x Pg16 1x Pg21	HC-STA-B10-HLFD-1STP16-EL-AL	1412618	1	
		HC-STA-B10-HLFD-1STP21-EL-AL	1412619	1	
Sleeve housing Height: 72 mm 	1x M25 1x M32	Cable outlet: lateral HC-STA-B10-HHFD-1STM25-EL-AL	1412592	1	
		HC-STA-B10-HHFD-1STM32-EL-AL	1412593	1	
	1x Pg21 1x Pg29	HC-STA-B10-HHFD-1STP21-EL-AL	1412594	1	
		HC-STA-B10-HHFD-1STP29-EL-AL	1412595	1	

Notes:
For further accessories, see page 642
Marking label: US-EMLP-HA (20X9), Order No. 0830989

Accessories

 Cable glands From page 680	 Protective cover From page 646	 Cover plates From page 648	 Connector set From page 624
---	---	---	--

new





Size B10, metal, STANDARD supporting base element with double locking latch



Technical data

General data	
Housing material	Die-cast aluminum, corrosion resistant
Locking latch material	Polyamide
Sealing material	NBR, conductive
Ambient temperature (operation)	-40 °C ... 125 °C
IP degree of protection (when plugged in)	IP66 / IP69K (ISO 20653:2013-02)
NEMA degree of protection (when plugged in)	4 / 4X / 12

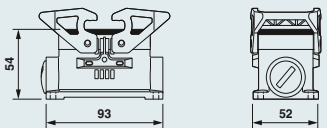
Ordering data

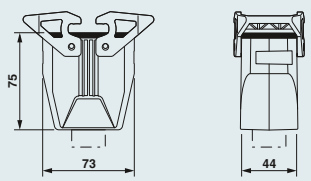
Description	Thread	Type	Order No.	Pcs. / Pkt.	Dimensions
Panel mounting base Height: 30.5 mm 		Without cover HC-STA-B10-BWD-ELC-AL	1411322	1	
Box mounting base¹⁾ Height: 54 mm 	2x M20 2x M25 2x Pg16	Without cover HC-STA-B10-SLWD-2SSM20-ELC-AL HC-STA-B10-SLWD-2SSM25-ELC-AL HC-STA-B10-SLWD-2SSP16-ELC-AL	1412835 1412836 1412837	1 1 1	
Coupling housing Height: 73 mm 	1x M20 1x M25 1x M32 1x Pg16 1x Pg21 1x Pg29	Cable outlet: top HC-STA-B10-CHWD-1TTM20-ELC-AL HC-STA-B10-CHWD-1TTM25-ELC-AL HC-STA-B10-CHWD-1TTM32-ELC-AL HC-STA-B10-CHWD-1TTP16-ELC-AL HC-STA-B10-CHWD-1TTP21-ELC-AL HC-STA-B10-CHWD-1TTP29-ELC-AL	1412578 1412579 1412580 1412581 1412582 1412583	1 1 1 1 1 1	

Notes:

- For further accessories, see page 642
- ¹⁾ Supplied with a plastic sealing cap

Accessories



Cable glands
From page 680



Replacement seals
From page 651



Replacement protective cover
From page 647



Replacement latch
From page 652

Heavy-duty connectors

HEAVYCON B - housing

Size B10, plastic, EVO housing, double locking latch









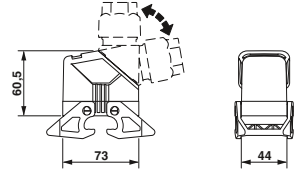

General data

Housing material	Polyamide
Locking latch material	Polyamide
Sealing material	NBR
Ambient temperature (operation)	-40 °C ... 125 °C
IP degree of protection (when plugged in)	IP66
NEMA degree of protection (when plugged in)	4 / 4X / 12

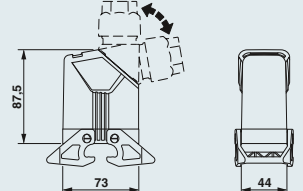
Technical data

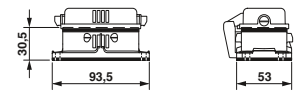
Housing material	Polyamide
Locking latch material	Polyamide
Sealing material	NBR
Ambient temperature (operation)	-40 °C ... 125 °C
IP degree of protection (when plugged in)	IP66
NEMA degree of protection (when plugged in)	4 / 4X / 12

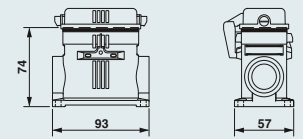
Ordering data

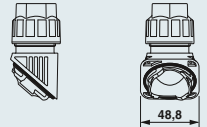
Description	Thread	Type	Order No.	Pcs. / Pkt.	Dimensions
Sleeve housing Height: 60.5 mm 		HC-EVO-B10-HLWD-PLBK	1407630	1	
Sleeve housing Height: 87.5 mm 		HC-EVO-B10-HHWD-PLBK	1407631	1	
Panel mounting base Height: 30.5 mm 		With cover HC-EVO-B10-BFDC-PLRBK	1407635	1	
Box mounting base¹⁾ Height: 74 mm 	2x M32	With cover HC-EVO-B10-SHFDC-2SSM32-PLRBK	1407639	1	
Cable gland 	Clamping area 7 mm ... 13 mm 9 mm ... 17 mm 11 mm ... 21 mm 19 mm ... 28 mm	HC-B-G-M20-PLRBK HC-B-G-M25-PLRBK HC-B-G-M32-PLRBK HC-B-G-M40-PLRBK	1407669 1407670 1407671 1407672	1 1 1 1	

Notes:

¹⁾ One cable entry is sealed with a knockout cover

Accessories



EVO unlocking
From page 653



Thread adapter
From page 643



Replacement seals
From page 650



Replacement latch
From page 652

Size B10, metal, EVO housing, double locking latch



General data	
Housing material	Die-cast aluminum, corrosion resistant
Locking latch material	Polyamide
Sealing material	NBR, conductive
Ambient temperature (operation)	-40 °C ... 125 °C
IP degree of protection (when plugged in)	IP66 / IP69K (ISO 20653:2013-02)
NEMA degree of protection (when plugged in)	4 / 4X / 12

Technical data	
Housing material	Die-cast aluminum, corrosion resistant
Locking latch material	Polyamide
Sealing material	NBR, conductive
Ambient temperature (operation)	-40 °C ... 125 °C
IP degree of protection (when plugged in)	IP66 / IP69K (ISO 20653:2013-02)
NEMA degree of protection (when plugged in)	4 / 4X / 12

Description		Thread	Type	Order No.	Pcs. / Pkt.	Dimensions
Sleeve housing Height: 64 mm			HC-EVO-B10-HLWD-EL-AL	1411457	1	
Sleeve housing Height: 80 mm			HC-EVO-B10-HHWD-EL-AL	1411454	1	
Panel mounting base Height: 30.5 mm			With cover HC-STA-B10-BFDC-ELC-AL	1411323	1	
Box mounting base ¹⁾ Height: 54 mm		2x M20 2x M25 2x Pg16	With cover HC-STA-B10-SLFDC-2SSM20-ELC-AL HC-STA-B10-SLFDC-2SSM25-ELC-AL HC-STA-B10-SLFDC-2SSP16-ELC-AL	1412830 1412831 1412832	1 1 1	
Cable gland		Clamping area 7 mm ... 13 mm 11 mm ... 16 mm 14 mm ... 21 mm 19 mm ... 27 mm	HC-B-G-M20-ER-AL HC-B-G-M25-ER-AL HC-B-G-M32-ER-AL HC-B-G-M40-ER-AL	1411442 1411443 1411444 1411445	1 1 1 1	

Notes:	
For further accessories, see page 642	
Marking label: US-EMLP-HA (20X9), Order No. 0830989	
¹⁾ Supplied with a plastic sealing cap	

Accessories

Thread adapter From page 643	EMC cable gland From page 642	Replacement seals From page 650	Replacement latch From page 652

Heavy-duty connectors

HEAVYCON B - housing

Size B10, metal, STANDARD sleeve housing with double locking latch

new







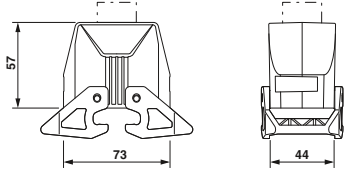

General data

Housing material	Die-cast aluminum, corrosion resistant
Locking latch material	PA
Sealing material	-
Ambient temperature (operation)	-40 °C ... 125 °C
IP degree of protection (when plugged in)	IP66 / IP69K (ISO 20653:2013-02)
NEMA degree of protection (when plugged in)	4 / 4X / 12

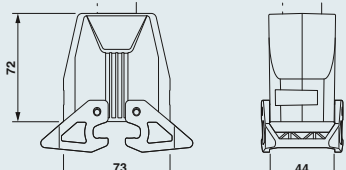
Technical data

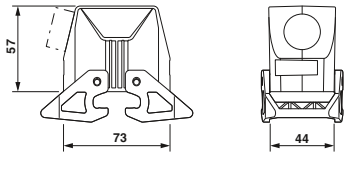
Ordering data

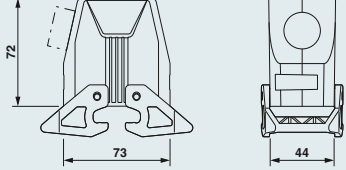
Description	Thread	Type	Order No.	Pcs. / Pkt.	Dimensions
Sleeve housing Height: 57 mm 	1x M20 1x M25	Cable outlet: top HC-STA-B10-HLWD-1TTM20-EL-AL	1412637	1	
		HC-STA-B10-HLWD-1TTM25-EL-AL	1412638	1	
	1x Pg16 1x Pg21	HC-STA-B10-HLWD-1TTP16-EL-AL	1412639	1	
		HC-STA-B10-HLWD-1TTP21-EL-AL	1412640	1	
Sleeve housing Height: 72 mm 	1x M25 1x M32	Cable outlet: top HC-STA-B10-HHWD-1TTM25-EL-AL	1412612	1	
		HC-STA-B10-HHWD-1TTM32-EL-AL	1412613	1	
	1x Pg21 1x Pg29	HC-STA-B10-HHWD-1TTP21-EL-AL	1412614	1	
		HC-STA-B10-HHWD-1TTP29-EL-AL	1412615	1	
Sleeve housing Height: 57 mm 	1x M20 1x M25	Cable outlet: lateral HC-STA-B10-HLWD-1STM20-EL-AL	1412633	1	
		HC-STA-B10-HLWD-1STM25-EL-AL	1412634	1	
	1x Pg16 1x Pg21	HC-STA-B10-HLWD-1STP16-EL-AL	1412635	1	
		HC-STA-B10-HLWD-1STP21-EL-AL	1412636	1	
Sleeve housing Height: 72 mm 	1x M25 1x M32	Cable outlet: lateral HC-STA-B10-HHWD-1STM25-EL-AL	1412608	1	
		HC-STA-B10-HHWD-1STM32-EL-AL	1412609	1	
	1x Pg21 1x Pg29	HC-STA-B10-HHWD-1STP21-EL-AL	1412610	1	
		HC-STA-B10-HHWD-1STP29-EL-AL	1412611	1	

Notes:

For further accessories, see page 642
 Marking label: US-EMLP-HA (20X9), Order No. 0830989

Accessories



Cable glands
From page 680



Replacement latch
From page 652



Protective cover
From page 646



**Size B10, metal,
STANDARD supporting base element
for double locking latch**



Technical data

General data	
Housing material	Die-cast aluminum, corrosion resistant
Locking latch material	-
Sealing material	NBR, conductive
Ambient temperature (operation)	-40 °C ... 125 °C
IP degree of protection (when plugged in)	IP66 / IP69K (ISO 20653:2013-02)
NEMA degree of protection (when plugged in)	4 / 4X / 12

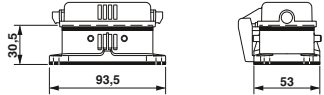
Ordering data

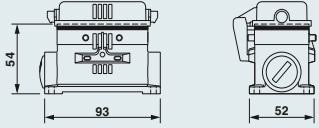
Description	Thread	Type	Order No.	Pcs. / Pkt.	Dimensions
Panel mounting base Height: 30.5 mm 		With cover HC-STA-B10-BFDC-ELC-AL	1411323	1	
Box mounting base¹⁾ Height: 54 mm 	2x M20 2x M25 2x Pg16	With cover HC-STA-B10-SLFDC-2SSM20-ELC-AL	1412830	1	
		HC-STA-B10-SLFDC-2SSM25-ELC-AL	1412831	1	
		HC-STA-B10-SLFDC-2SSP16-ELC-AL	1412832	1	

Notes:

- For further accessories, see page 642
- ¹⁾ Supplied with a plastic sealing cap

Accessories



Cable glands
From page 680



Replacement seals
From page 651



Replacement protective cover
From page 647



Cover plates
From page 648

Heavy-duty connectors

HEAVYCON B - housing

Size B16, plastic, ADVANCE sleeve housing with cable gland







General data

Housing material
Lock material
Sealing material
Ambient temperature (operation)
IP degree of protection (when plugged in)
NEMA degree of protection (when plugged in)

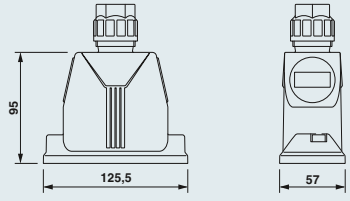
Technical data	
Housing material	Polyamide
Lock material	Stainless steel
Sealing material	NBR
Ambient temperature (operation)	-40 °C ... 100 °C
IP degree of protection (when plugged in)	IP66 / IP68 (0.2 bar/24 h)
NEMA degree of protection (when plugged in)	4 / 4X / 6P / 12

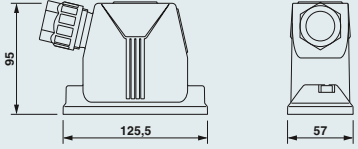

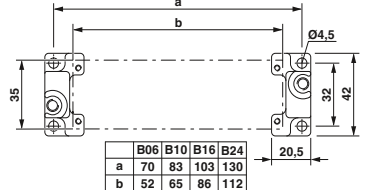
Ordering data

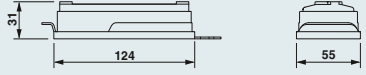
Description	Thread	Type	Order No.	Pcs. / Pkt.	Dimensions															
Sleeve housing Height: 95 mm 	1x M32 1x M40	Cable outlet: top HC-ADV-B16-HHWH-1TGM32-PL HC-ADV-B16-HHWH-1TGM40-PL	1404231 1404233	1 1																
Sleeve housing Height: 95 mm 	1x M32 1x M40	Cable outlet: lateral HC-ADV-B16-HHWH-1SGM32-PL HC-ADV-B16-HHWH-1SGM40-PL	1404232 1404234	1 1																
Panel mounting flange¹⁾ 		2 pcs. per housing HC-B-AF Set with 2 panel mounting flanges HC-B-AF-SET	1686533 1604638	20 1	 <table border="1" data-bbox="1204 1533 1356 1585"> <thead> <tr> <th></th> <th>B06</th> <th>B10</th> <th>B16</th> <th>B24</th> </tr> </thead> <tbody> <tr> <td>a</td> <td>70</td> <td>83</td> <td>103</td> <td>130</td> </tr> <tr> <td>b</td> <td>52</td> <td>65</td> <td>86</td> <td>112</td> </tr> </tbody> </table>		B06	B10	B16	B24	a	70	83	103	130	b	52	65	86	112
	B06	B10	B16	B24																
a	70	83	103	130																
b	52	65	86	112																
Protective cover 		For sleeve side, IP50 HC-B 16-TMS-SD-IP50 For panel mounting side, IP66 HC-B 16-TMS-SD-IP66	1690752 1411517	10 10																

Notes:
 Marking label: US-EMP (20X9) Order No. 0829439
¹⁾ Bore hole Ø 4.5 mm when using M4 screws, bore hole Ø 3.6 mm when using self-tapping M4 screws (Torx®)

Accessories

 Box mounting base phoenixcontact.net/products	 Allen key See Catalog 5	 Replacement seals From page 651
---	--	--

new



Size B16, metal, ADVANCE sleeve housing, Offshore/EMC









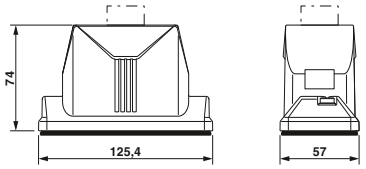

Technical data

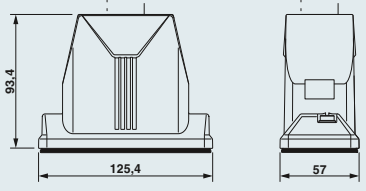
General data

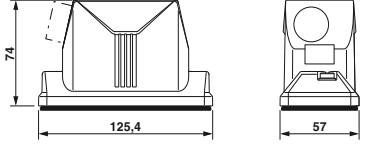
Housing material
Lock material
Sealing material
Ambient temperature (operation)
IP degree of protection (when plugged in)
NEMA degree of protection (when plugged in)

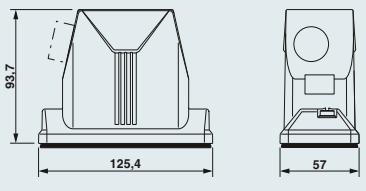
Die-cast aluminum, corrosion resistant
Stainless steel
NBR, conductive
-40 °C ... 125 °C
IP66 / IP68 (0.2 bar/24 h) / IP69K (ISO 20653:2013-02)
4 / 4X / 6P / 12

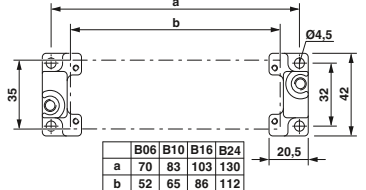
Ordering data

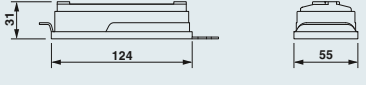
Description	Thread	Type	Order No.	Pcs. / Pkt.	Dimensions															
Sleeve housing¹⁾ Height: 74 mm 	1x M25	Cable outlet: top HC-ADV-B16-HLWH-1TTM25-EMC-AL	1414975	1																
Sleeve housing¹⁾ Height: 93.7 mm 	1x M25 1x M32 1x M40	Cable outlet: top HC-ADV-B16-HHWH-1TTM25-EMC-AL HC-ADV-B16-HHWH-1TTM32-EMC-AL HC-ADV-B16-HHWH-1TTM40-EMC-AL	1414977 1413416 1413418	1 1 1																
Cable entry: lateral¹⁾ Height: 74 mm 	1x M25	Cable outlet: lateral HC-ADV-B16-HLWH-1STM25-EMC-AL	1414976	1																
Sleeve housing¹⁾ Height: 93.7 mm 	1x M25 1x M32 1x M40	Cable outlet: lateral HC-ADV-B16-HHWH-1STM25-EMC-AL HC-ADV-B16-HHWH-1STM32-EMC-AL HC-ADV-B16-HHWH-1STM40-EMC-AL	1414978 1413417 1413419	1 1 1																
Panel mounting flange²⁾ 		2 pcs. per housing HC-B-AF Set with 2 panel mounting flanges HC-B-AF-SET	1686533 1604638	20 1	 <table border="1" data-bbox="1189 1533 1340 1585"> <tr> <td></td> <td>B06</td> <td>B10</td> <td>B16</td> <td>B24</td> </tr> <tr> <td>a</td> <td>70</td> <td>83</td> <td>103</td> <td>130</td> </tr> <tr> <td>b</td> <td>52</td> <td>65</td> <td>86</td> <td>112</td> </tr> </table>		B06	B10	B16	B24	a	70	83	103	130	b	52	65	86	112
	B06	B10	B16	B24																
a	70	83	103	130																
b	52	65	86	112																
Protective cover 		For sleeve side, IP50 HC-B 16-TMS-SD-IP50 For panel mounting side, IP66 HC-B 16-TMS-SD-IP66	1690752 1411517	10 10																

Notes:

In order to achieve optimum shielding results, the mounting surface must be conductive

Marking label: US-EMLP-HA (20X9), Order No. 0830989

¹⁾ Screw locking with M6 Allen screws

²⁾ Bore hole \varnothing 4.5 mm when using M4 screws, bore hole \varnothing 3.6 mm when using self-tapping M4 screws (Torx[®])

Accessories



Cable glands
From page 680



Box mounting base
phoenixcontact.net/products



Allen key
See Catalog 5



Replacement seals
From page 651

Heavy-duty connectors

HEAVYCON B - housing

Size B16, plastic, EVO housing, single locking latch



General data

Housing material	Polyamide
Locking latch material	Polyamide
Sealing material	NBR
Ambient temperature (operation)	-40 °C ... 125 °C
IP degree of protection (when plugged in)	IP66
NEMA degree of protection (when plugged in)	4 / 4X / 12

Technical data

Ordering data

Description

Thread

Type

Order No.

Pcs. / Pkt.

Dimensions

Sleeve housing Height: 78 mm



HC-EVO-B16-HHFS-PLBK

1407642

1

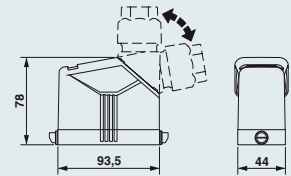

Panel mounting base Height: 30.5 mm



Without cover

HC-EVO-B16-BWS-PLRBK

1407646

1

With cover

HC-EVO-B16-BWSC-PLRBK

1407647

1

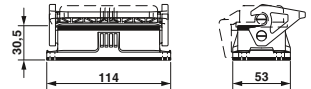

Box mounting base¹⁾ Height: 84 mm



2x M40

Without cover

HC-EVO-B16-SHWS-2SSM40-PLRBK

1407650

1

With cover

HC-EVO-B16-SHWSC-2SSM40-PLRBK

1407651

1

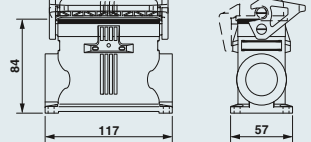

Coupling housing Height: 81 mm



HC-EVO-B16-CHWS-PLRBK

1407654

1

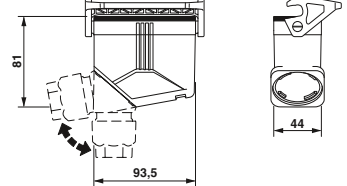

Cable gland



Clamping area

7 mm ... 13 mm
9 mm ... 17 mm
11 mm ... 21 mm
19 mm ... 28 mm

HC-B-G-M20-PLRBK

1407669

1

HC-B-G-M25-PLRBK

1407670

1

HC-B-G-M32-PLRBK

1407671

1

HC-B-G-M40-PLRBK

1407672

1

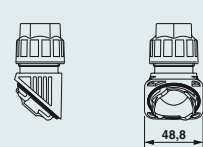

Notes:

For further accessories, see page 642

Marking label: US-EMP (20X9) Order No. [0829439](#)

¹⁾ One cable entry is sealed with a knockout cover

Accessories



EVO unlocking
From page 653



Thread adapter
From page 643



Replacement seals
From page 650



Connector set
From page 622









Size B16, metal, EVO housing, single locking latch

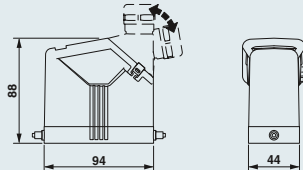

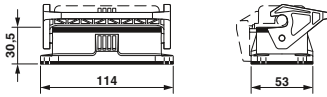
Technical data

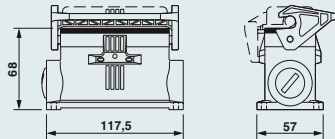
General data	
Housing material	Die-cast aluminum, corrosion resistant
Locking latch material	Polyamide
Sealing material	NBR, conductive
Ambient temperature (operation)	-40 °C ... 125 °C
IP degree of protection (when plugged in)	IP66 / IP69K (ISO 20653:2013-02)
NEMA degree of protection (when plugged in)	4 / 4X / 12

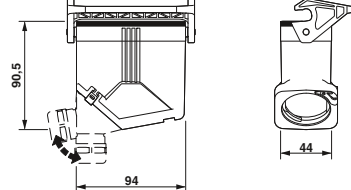
Ordering data

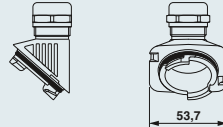
Description	Thread	Type	Order No.	Pcs. / Pkt.	Dimensions
Sleeve housing Height: 88 mm 		HC-EVO-B16-HHFS-EL-AL	1411461	1	
Panel mounting base Height: 30.5 mm 		Without cover HC-STA-B16-BWS-ELC-AL With cover HC-STA-B16-BWSC-ELC-AL	1411324 1411325	1 1	
Box mounting base¹⁾ Height: 68 mm 	2x M25 2x M32 2x Pg21	Without cover HC-STA-B16-SLWS-2SSM25-ELC-AL HC-STA-B16-SLWS-2SSM32-ELC-AL HC-STA-B16-SLWS-2SSP21-ELC-AL With cover HC-STA-B16-SLWSC-2SSM25-ELC-AL HC-STA-B16-SLWSC-2SSM32-ELC-AL HC-STA-B16-SLWSC-2SSP21-ELC-AL	1412861 1412862 1412863 1412865 1412866 1412867	1 1 1 1 1 1	
Coupling housing Height: 90.5 mm 		HC-EVO-B16-CHWS-ELC-AL	1411464	1	
Cable gland 	Clamping area 7 mm ... 13 mm 11 mm ... 16 mm 14 mm ... 21 mm 19 mm ... 27 mm	HC-B-G-M20-ER-AL HC-B-G-M25-ER-AL HC-B-G-M32-ER-AL HC-B-G-M40-ER-AL	1411442 1411443 1411444 1411445	1 1 1 1	

Notes:

- For further accessories, see page 642
- Marking label: US-EMLP-HA (20X9), Order No. 0830989
- ¹⁾ Supplied with a plastic sealing cap

Accessories



Thread adapter
From page 643



EMC cable gland
From page 642



Replacement seals
From page 650



Connector set
From page 623

Heavy-duty connectors

HEAVYCON B - housing

Size B16, metal, STANDARD sleeve housing for single locking latch

new







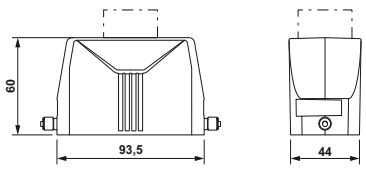

General data

Housing material
Locking latch material
Sealing material
Ambient temperature (operation)
IP degree of protection (when plugged in)
NEMA degree of protection (when plugged in)

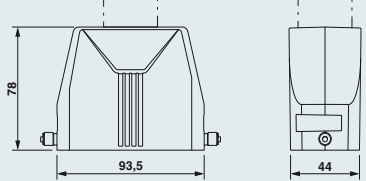
Technical data
Die-cast aluminum, corrosion resistant
-
-
-40 °C ... 125 °C
IP66 / IP69K (ISO 20653:2013-02)
4 / 4X / 12

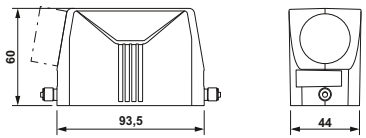
Ordering data

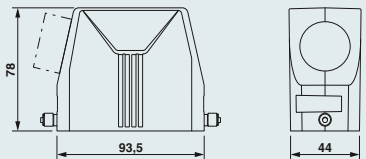
Description	Thread	Type	Order No.	Pcs. / Pkt.	Dimensions
Sleeve housing Height: 60 mm 	1x M25 1x M32	Cable outlet: top HC-STA-B16-HLFS-1TTM25-EL-AL	1412729	1	
		HC-STA-B16-HLFS-1TTM32-EL-AL	1412730	1	
	1x Pg16 1x Pg21	HC-STA-B16-HLFS-1TTP16-EL-AL	1412731	1	
		HC-STA-B16-HLFS-1TTP21-EL-AL	1412732	1	
Sleeve housing Height: 76 mm 	1x M32 1x M40	Cable outlet: top HC-STA-B16-HHFS-1TTM32-EL-AL	1412689	1	
		HC-STA-B16-HHFS-1TTM40-EL-AL	1412700	1	
	1x Pg21 1x Pg29	HC-STA-B16-HHFS-1TTP21-EL-AL	1412701	1	
		HC-STA-B16-HHFS-1TTP29-EL-AL	1412702	1	
Sleeve housing Height: 60 mm 	1x M25 1x M32	Cable outlet: lateral HC-STA-B16-HLFS-1STM25-EL-AL	1412725	1	
		HC-STA-B16-HLFS-1STM32-EL-AL	1412726	1	
	1x Pg16 1x Pg21	HC-STA-B16-HLFS-1STP16-EL-AL	1412727	1	
		HC-STA-B16-HLFS-1STP21-EL-AL	1412728	1	
Sleeve housing Height: 76 mm 	1x M32 1x M40	Cable outlet: lateral HC-STA-B16-HHFS-1STM32-EL-AL	1412679	1	
		HC-STA-B16-HHFS-1STM40-EL-AL	1412682	1	
	1x Pg21 1x Pg29	HC-STA-B16-HHFS-1STP21-EL-AL	1412683	1	
		HC-STA-B16-HHFS-1STP29-EL-AL	1412684	1	

Notes:
For further accessories, see page 642
Marking label: US-EMLP-HA (20X9), Order No. 0830989

Accessories

 Cable glands From page 680	 Protective cover From page 646	 Cover plates From page 648	 Connector set From page 624
---	---	---	--







Size B16, metal, STANDARD supporting base element with single locking latch

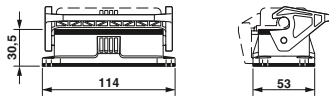

Technical data

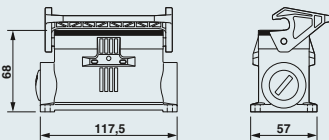
General data	
Housing material	Die-cast aluminum, corrosion resistant
Locking latch material	Polyamide
Sealing material	NBR, conductive
Ambient temperature (operation)	-40 °C ... 125 °C
IP degree of protection (when plugged in)	IP66 / IP69K (ISO 20653:2013-02)
NEMA degree of protection (when plugged in)	4 / 4X / 12

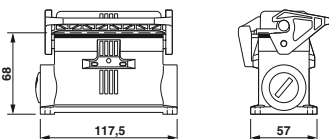
Ordering data

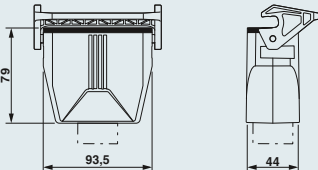
Description	Thread	Type	Order No.	Pcs. / Pkt.	Dimensions
Panel mounting base Height: 30.5 mm 		Without cover HC-STA-B16-BWS-ELC-AL	1411324	1	
		With cover HC-STA-B16-BWSC-ELC-AL	1411325	1	
Box mounting base¹⁾ Height: 68 mm 	2x M25 2x M32 2x Pg21	Without cover HC-STA-B16-SLWS-2SSM25-ELC-AL	1412861	1	
		HC-STA-B16-SLWS-2SSM32-ELC-AL	1412862	1	
		HC-STA-B16-SLWS-2SSP21-ELC-AL	1412863	1	
Box mounting base¹⁾ Height: 68 mm 	2x M25 2x M32 2x Pg21	With cover HC-STA-B16-SLWSC-2SSM25-ELC-AL	1412865	1	
		HC-STA-B16-SLWSC-2SSM32-ELC-AL	1412866	1	
		HC-STA-B16-SLWSC-2SSP21-ELC-AL	1412867	1	
Coupling housing Height: 79 mm 	1x M25 1x M32 1x Pg21 1x Pg29	Cable outlet: top HC-STA-B16-CHWS-1TTM25-ELC-AL	1412645	1	
		HC-STA-B16-CHWS-1TTM32-ELC-AL	1412646	1	
		HC-STA-B16-CHWS-1TTP21-ELC-AL	1412647	1	
		HC-STA-B16-CHWS-1TTP29-ELC-AL	1412648	1	

Notes:

For further accessories, see page 642

¹⁾ Supplied with a plastic sealing cap

Accessories



Cable glands
From page 680



Replacement seals
From page 651



Replacement protective cover
From page 647



Replacement latch
From page 652

Heavy-duty connectors

HEAVYCON B - housing

Size B16, plastic, EVO housing, double locking latch











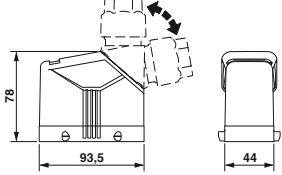

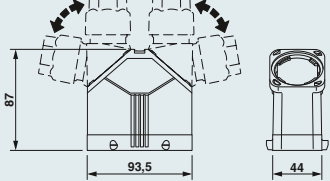
General data

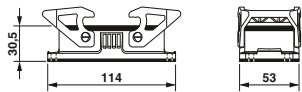
Housing material	Polyamide
Locking latch material	Polyamide
Sealing material	NBR
Ambient temperature (operation)	-40 °C ... 125 °C
IP degree of protection (when plugged in)	IP66
NEMA degree of protection (when plugged in)	4 / 4X / 12

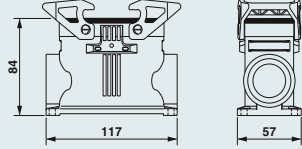
Technical data

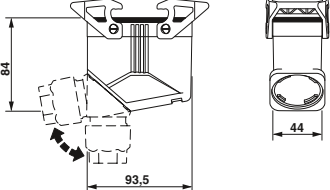
Ordering data

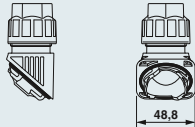
Description	Thread	Type	Order No.	Pcs. / Pkt.	Dimensions
Sleeve housing Height: 78 mm 		HC-EVO-B16-HHFD-PLBK	1407643	1	
Double sleeve housing Height: 78 mm 		HC-EVO-B16-HHFD-2B-PL-BK	1411496	1	
Panel mounting base Height: 30.5 mm 		Without cover HC-EVO-B16-BWD-PLRBK	1407648	1	
Box mounting base¹⁾ Height: 84 mm 	2x M40	Without cover HC-EVO-B16-SHWD-2SSM40-PLRBK	1407652	1	
Coupling housing Height: 84 mm 		HC-EVO-B16-CHWD-PLRBK	1407655	1	
Cable gland 	Clamping area 7 mm ... 13 mm 9 mm ... 17 mm 11 mm ... 21 mm 19 mm ... 28 mm	HC-B-G-M20-PLRBK HC-B-G-M25-PLRBK HC-B-G-M32-PLRBK HC-B-G-M40-PLRBK	1407669 1407670 1407671 1407672	1 1 1 1	

Notes:

For further accessories, see page 642

Marking label: US-EMP (20X9) Order No. 0829439

¹⁾ One cable entry is sealed with a knockout cover

Accessories



EVO unlocking
From page 653



Thread adapter
From page 643



Replacement seals
From page 650



Connector set
From page 622









Size B16, metal, EVO housing, double locking latch

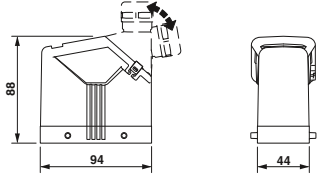

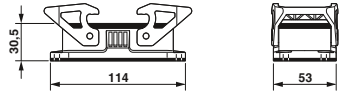
Technical data

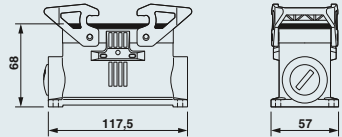
General data	
Housing material	Die-cast aluminum, corrosion resistant
Locking latch material	Polyamide
Sealing material	NBR, conductive
Ambient temperature (operation)	-40 °C ... 125 °C
IP degree of protection (when plugged in)	IP66 / IP69K (ISO 20653:2013-02)
NEMA degree of protection (when plugged in)	4 / 4X / 12

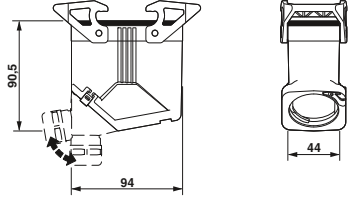
Ordering data

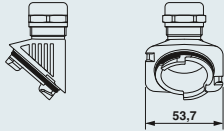
Description	Thread	Type	Order No.	Pcs. / Pkt.	Dimensions
Sleeve housing Height: 88 mm 		HC-EVO-B16-HHFD-EL-AL	1411460	1	
Panel mounting base Height: 30.5 mm 		Without cover HC-STA-B16-BWD-ELC-AL	1411327	1	
Box mounting base¹⁾ Height: 54.6 mm 	2x M25 2x M32 2x Pg21	Without cover HC-STA-B16-SLWD-2SSM25-ELC-AL HC-STA-B16-SLWD-2SSM32-ELC-AL HC-STA-B16-SLWD-2SSP21-ELC-AL	1412855 1412856 1412857	1 1 1	
Coupling housing Height: 90.5 mm 		HC-EVO-B16-CHWD-ELC-AL	1411463	1	
Cable gland 	Clamping area 7 mm ... 13 mm 11 mm ... 16 mm 14 mm ... 21 mm 19 mm ... 27 mm	HC-B-G-M20-ER-AL HC-B-G-M25-ER-AL HC-B-G-M32-ER-AL HC-B-G-M40-ER-AL	1411442 1411443 1411444 1411445	1 1 1 1	

Notes:

- For further accessories, see page 642
- Marking label: US-EMLP-HA (20X9), Order No. 0830989
- ¹⁾ Supplied with a plastic sealing cap

Accessories



Thread adapter
From page 643



EMC cable gland
From page 642



Replacement seals
From page 650



Connector set
From page 623

Heavy-duty connectors

HEAVYCON B - housing

Size B16, metal, STANDARD sleeve housing for double locking latch

new







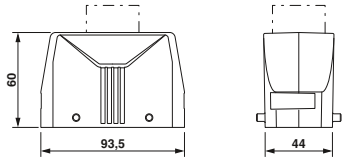

General data

Housing material
Locking latch material
Sealing material
Ambient temperature (operation)
IP degree of protection (when plugged in)
NEMA degree of protection (when plugged in)

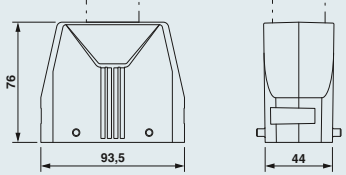
Technical data
Die-cast aluminum, corrosion resistant
-
-
-40 °C ... 125 °C
IP66 / IP69K (ISO 20653:2013-02)
4 / 4X / 12

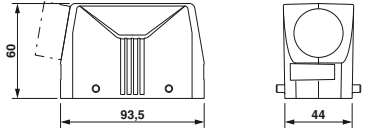
Ordering data

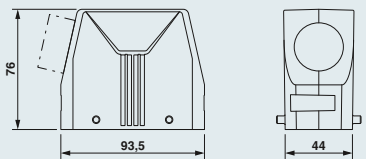
Description	Thread	Type	Order No.	Pcs. / Pkt.	Dimensions
Sleeve housing Height: 60 mm 	1x M25 1x M32	Cable outlet: top HC-STA-B16-HLFD-1TTM25-EL-AL	1412721	1	
		HC-STA-B16-HLFD-1TTM32-EL-AL	1412722	1	
	1x Pg16 1x Pg21	HC-STA-B16-HLFD-1TTP16-EL-AL	1412723	1	
		HC-STA-B16-HLFD-1TTP21-EL-AL	1412724	1	
Sleeve housing Height: 76 mm 	1x M32 1x M40	Cable outlet: top HC-STA-B16-HHFD-1TTM32-EL-AL	1412653	1	
		HC-STA-B16-HHFD-1TTM40-EL-AL	1412654	1	
	1x Pg21 1x Pg29	HC-STA-B16-HHFD-1TTP21-EL-AL	1412669	1	
		HC-STA-B16-HHFD-1TTP29-EL-AL	1412678	1	
Sleeve housing Height: 60 mm 	1x M25 1x M32	Cable outlet: lateral HC-STA-B16-HLFD-1STM25-EL-AL	1412717	1	
		HC-STA-B16-HLFD-1STM32-EL-AL	1412718	1	
	1x Pg16 1x Pg21	HC-STA-B16-HLFD-1STP16-EL-AL	1412719	1	
		HC-STA-B16-HLFD-1STP21-EL-AL	1412720	1	
Sleeve housing Height: 76 mm 	1x M32 1x M40	Cable outlet: lateral HC-STA-B16-HHFD-1STM32-EL-AL	1412649	1	
		HC-STA-B16-HHFD-1STM40-EL-AL	1412650	1	
	1x Pg21 1x Pg29	HC-STA-B16-HHFD-1STP21-EL-AL	1412651	1	
		HC-STA-B16-HHFD-1STP29-EL-AL	1412652	1	

Notes:
For further accessories, see page 642
Marking label: US-EMLP-HA (20X9), Order No. 0830989

Accessories

 Cable glands From page 680	 Protective cover From page 646	 Cover plates From page 648	 Connector set From page 624
---	---	---	--

new



Size B16, metal, STANDARD supporting base element with double locking latch





General data

Housing material
Locking latch material
Sealing material
Ambient temperature (operation)
IP degree of protection (when plugged in)
NEMA degree of protection (when plugged in)

Technical data

Die-cast aluminum, corrosion resistant
Polyamide
NBR, conductive
-40 °C ... 125 °C
IP66 / IP69K (ISO 20653:2013-02)
4 / 4X / 12

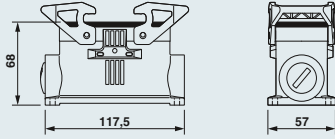
Ordering data

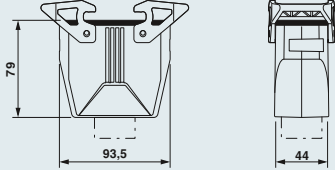
Description	Thread	Type	Order No.	Pcs. / Pkt.	Dimensions
Panel mounting base Height: 30.5 mm 		Without cover HC-STA-B16-BWD-ELC-AL	1411327	1	
Box mounting base¹⁾ Height: 54.6 mm 	2x M25 2x M32 2x Pg21	Without cover HC-STA-B16-SLWD-2SSM25-ELC-AL HC-STA-B16-SLWD-2SSM32-ELC-AL HC-STA-B16-SLWD-2SSP21-ELC-AL	1412855 1412856 1412857	1 1 1	
Coupling housing Height: 79 mm 	1x M25 1x M32 1x Pg21 1x Pg29	Cable outlet: top HC-STA-B16-CHWD-1TTM25-ELC-AL HC-STA-B16-CHWD-1TTM32-ELC-AL HC-STA-B16-CHWD-1TTP21-ELC-AL HC-STA-B16-CHWD-1TTP29-ELC-AL	1412641 1412642 1412643 1412644	1 1 1 1	

Notes:

For further accessories, see page 642
¹⁾ Supplied with a plastic sealing cap

Accessories



Cable glands
From page 680



Replacement seals
From page 651



Replacement protective cover
From page 647



Replacement latch
From page 652

Heavy-duty connectors

HEAVYCON B - housing

Size B16, plastic, EVO housing, double locking latch



General data

Housing material	Polyamide
Locking latch material	Polyamide
Sealing material	NBR
Ambient temperature (operation)	-40 °C ... 125 °C
IP degree of protection (when plugged in)	IP66
NEMA degree of protection (when plugged in)	4 / 4X / 12

Technical data

Ordering data

Description

Thread

Type

Order No.

Pcs. / Pkt.

Dimensions

Sleeve housing Height: 78 mm



HC-EVO-B16-HHWD-PLBK

1407644

1

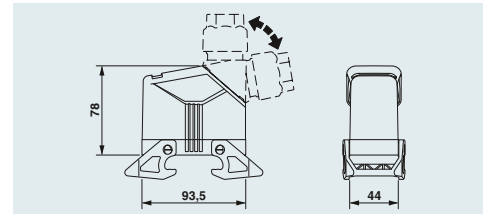

Panel mounting base Height: 30.5 mm



With cover
HC-EVO-B16-BFDC-PLRBK

1407649

1

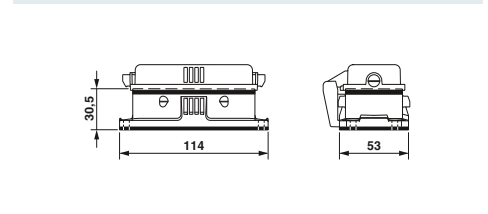

Box mounting base¹⁾ Height: 84 mm

2x M40



With cover
HC-EVO-B16-SHFDC-2SSM40-PLRBK

1407653

1

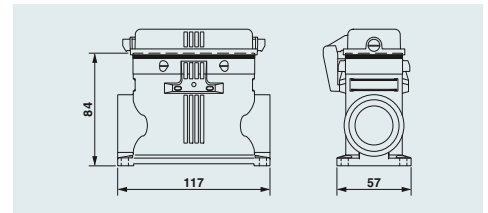

Cable gland

Clamping area

7 mm ... 13 mm
9 mm ... 17 mm
11 mm ... 21 mm
19 mm ... 28 mm



HC-B-G-M20-PLRBK
HC-B-G-M25-PLRBK
HC-B-G-M32-PLRBK
HC-B-G-M40-PLRBK

1407669
1407670
1407671
1407672

1
1
1
1

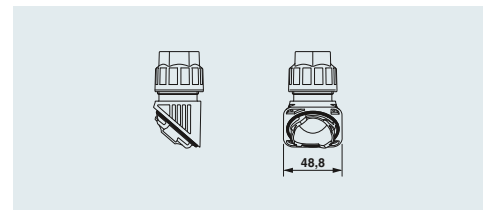

Notes:

¹⁾ One cable entry is sealed with a knockout cover

Accessories



EVO unlocking
From page 653



Thread adapter
From page 643



Replacement seals
From page 650



Replacement latch
From page 652







Size B16, metal, EVO housing, double locking latch

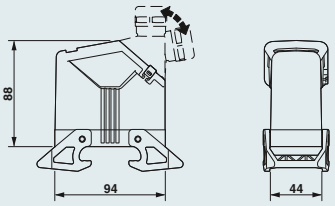

Technical data

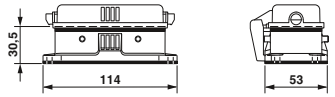
General data	
Housing material	Die-cast aluminum, corrosion resistant
Locking latch material	Polyamide
Sealing material	NBR, conductive
Ambient temperature (operation)	-40 °C ... 125 °C
IP degree of protection (when plugged in)	IP66 / IP69K (ISO 20653:2013-02)
NEMA degree of protection (when plugged in)	4 / 4X / 12

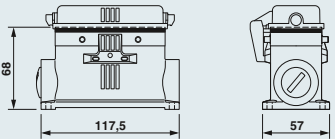
Ordering data

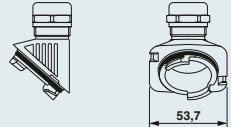
Description	Thread	Type	Order No.	Pcs. / Pkt.	Dimensions
Sleeve housing Height: 88 mm 		HC-EVO-B16-HHWD-EL-AL	1411462	1	
Panel mounting base Height: 30.5 mm 		With cover HC-STA-B16-BFDC-ELC-AL	1411328	1	
Box mounting base¹⁾ Height: 68 mm 	2x M25 2x M32 2x Pg16 2x Pg21	With cover HC-STA-B16-SLFDC-2SSM25-ELC-AL HC-STA-B16-SLFDC-2SSM32-ELC-AL HC-STA-B16-SLFDC-2SSP16-ELC-AL HC-STA-B16-SLFDC-2SSP21-ELC-AL	1412849 1412850 1412852 1412853	1 1 1 1	
Cable gland 	Clamping area 7 mm ... 13 mm 11 mm ... 16 mm 14 mm ... 21 mm 19 mm ... 27 mm	HC-B-G-M20-ER-AL HC-B-G-M25-ER-AL HC-B-G-M32-ER-AL HC-B-G-M40-ER-AL	1411442 1411443 1411444 1411445	1 1 1 1	

Notes:

For further accessories, see page 642

¹⁾ Supplied with a plastic sealing cap

Accessories



Thread adapter
From page 643



EMC cable gland
From page 642



Replacement seals
From page 650



Replacement latch
From page 652

Heavy-duty connectors

HEAVYCON B - housing

Size B16, metal, STANDARD sleeve housing with double locking latch

new







General data

Housing material
Locking latch material
Sealing material
Ambient temperature (operation)
IP degree of protection (when plugged in)
NEMA degree of protection (when plugged in)

Technical data
Die-cast aluminum, corrosion resistant
PA
-
-40 °C ... 125 °C
IP66 / IP69K (ISO 20653:2013-02)
4 / 4X / 12

Ordering data

Description	Thread	Type	Order No.	Pcs. / Pkt.	Dimensions
Sleeve housing Height: 60 mm 	1x M25 1x M32	Cable outlet: top HC-STA-B16-HLWD-1TTM25-EL-AL	1412738	1	
		HC-STA-B16-HLWD-1TTM32-EL-AL	1412739	1	
	1x Pg16 1x Pg21	HC-STA-B16-HLWD-1TTP16-EL-AL	1412740	1	
		HC-STA-B16-HLWD-1TTP21-EL-AL	1412741	1	
Sleeve housing Height: 76 mm 	1x M32 1x M40	Cable outlet: top HC-STA-B16-HHWD-1TTM32-EL-AL	1412708	1	
		HC-STA-B16-HHWD-1TTM40-EL-AL	1412709	1	
	1x Pg21 1x Pg29	HC-STA-B16-HHWD-1TTP21-EL-AL	1412715	1	
		HC-STA-B16-HHWD-1TTP29-EL-AL	1412716	1	
Sleeve housing Height: 60 mm 	1x M25 1x M32	Cable outlet: lateral HC-STA-B16-HLWD-1STM25-EL-AL	1412733	1	
		HC-STA-B16-HLWD-1STM32-EL-AL	1412734	1	
	1x Pg16 1x Pg21	HC-STA-B16-HLWD-1STP16-EL-AL	1412735	1	
		HC-STA-B16-HLWD-1STP21-EL-AL	1412737	1	
Sleeve housing Height: 76 mm 	1x M32 1x M40	Cable outlet: lateral HC-STA-B16-HHWD-1STM32-EL-AL	1412703	1	
		HC-STA-B16-HHWD-1STM40-EL-AL	1412704	1	
	1x Pg21 1x Pg29	HC-STA-B16-HHWD-1STP21-EL-AL	1412705	1	
		HC-STA-B16-HHWD-1STP29-EL-AL	1412706	1	

Notes: Accessories

For further accessories, see page 642
Marking label: US-EMLP-HA (20X9), Order No. [0830989](#)



 Cable glands From page 680	 Protective cover From page 646	 Replacement latch From page 652
---	---	--



**Size B16, metal,
STANDARD supporting base element
for double locking latch**



General data	
Housing material	Die-cast aluminum, corrosion resistant
Locking latch material	-
Sealing material	NBR, conductive
Ambient temperature (operation)	-40 °C ... 125 °C
IP degree of protection (when plugged in)	IP66 / IP69K (ISO 20653:2013-02)
NEMA degree of protection (when plugged in)	4 / 4X / 12

Technical data	
Housing material	Die-cast aluminum, corrosion resistant
Locking latch material	-
Sealing material	NBR, conductive
Ambient temperature (operation)	-40 °C ... 125 °C
IP degree of protection (when plugged in)	IP66 / IP69K (ISO 20653:2013-02)
NEMA degree of protection (when plugged in)	4 / 4X / 12

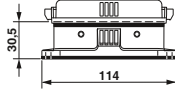
Description		Thread	Type	Order No.	Pcs. / Pkt.
Panel mounting base Height: 30.5 mm 			With cover HC-STA-B16-BFDC-ELC-AL	1411328	1
Box mounting base¹⁾ Height: 68 mm 		2x M25 2x M32 2x Pg16 2x Pg21	With cover HC-STA-B16-SLFDC-2SSM25-ELC-AL HC-STA-B16-SLFDC-2SSM32-ELC-AL HC-STA-B16-SLFDC-2SSP16-ELC-AL HC-STA-B16-SLFDC-2SSP21-ELC-AL	1412849 1412850 1412852 1412853	1 1 1 1

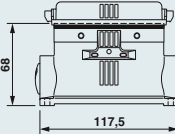
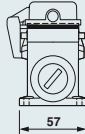
Dimensions	
	
30,5 114	53
	
68 117,5	57

Notes:
For further accessories, see page 642
¹⁾ Supplied with a plastic sealing cap

Accessories

			
Cable glands From page 680	Replacement seals From page 651	Replacement protective cover From page 647	Cover plates From page 648

Heavy-duty connectors

HEAVYCON B - housing

Size B24, plastic, ADVANCE sleeve housing with cable gland

General data







Housing material
Lock material
Sealing material
Ambient temperature (operation)
IP degree of protection (when plugged in)
NEMA degree of protection (when plugged in)

Technical data

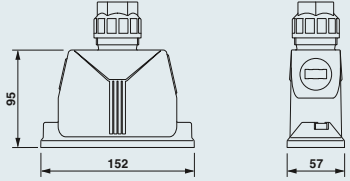
Polyamide
Stainless steel
NBR
-40 °C ... 100 °C
IP66 / IP68 (0.2 bar/24 h)
4 / 4X / 6P / 12

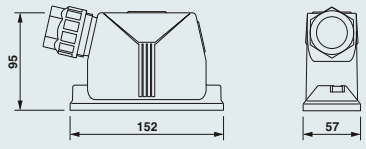

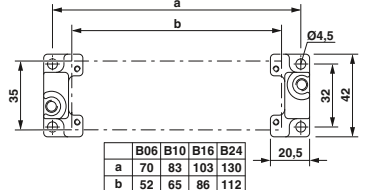
Ordering data

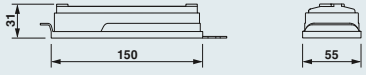
Description	Thread	Type	Order No.	Pcs. / Pkt.	Dimensions															
Sleeve housing Height: 95 mm 	1x M32 1x M40	Cable outlet: top HC-ADV-B24-HHWH-1TGM32-PL HC-ADV-B24-HHWH-1TGM40-PL	1404235 1404238	1 1																
Sleeve housing Height: 95 mm 	1x M32 1x M40	Cable outlet: lateral HC-ADV-B24-HHWH-1SGM32-PL HC-ADV-B24-HHWH-1SGM40-PL	1404237 1404239	1 1																
Panel mounting flange¹⁾ 		2 pcs. per housing HC-B-AF Set with 2 panel mounting flanges HC-B-AF-SET	1686533 1604638	20 1	 <table border="1" data-bbox="1204 1533 1356 1585"> <thead> <tr> <th></th> <th>B06</th> <th>B10</th> <th>B16</th> <th>B24</th> </tr> </thead> <tbody> <tr> <td>a</td> <td>70</td> <td>83</td> <td>103</td> <td>130</td> </tr> <tr> <td>b</td> <td>52</td> <td>65</td> <td>86</td> <td>112</td> </tr> </tbody> </table>		B06	B10	B16	B24	a	70	83	103	130	b	52	65	86	112
	B06	B10	B16	B24																
a	70	83	103	130																
b	52	65	86	112																
Protective cover 		For sleeve side, IP50 HC-B 24-TMS-SD-IP50 For panel mounting side, IP66 HC-B 24-TMS-SD-IP66	1690765 1411520	10 10																

Notes:

Marking label: US-EMP (20X9) Order No. **0829439**

¹⁾ Bore hole Ø 4.5 mm when using M4 screws, bore hole Ø 3.6 mm when using self-tapping M4 screws (Torx®)

Accessories



Box mounting base
phoenixcontact.net/products



Allen key
See Catalog 5



Replacement seals
From page 651

new



Size B24, metal, ADVANCE sleeve housing, Offshore/EMC









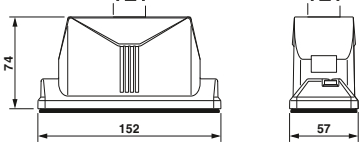

Technical data

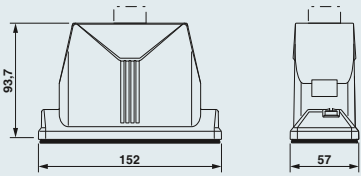
General data

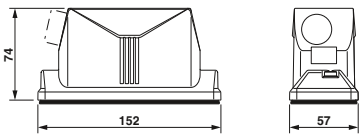
Housing material
Lock material
Sealing material
Ambient temperature (operation)
IP degree of protection (when plugged in)
NEMA degree of protection (when plugged in)

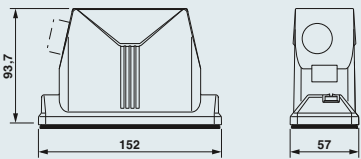
Die-cast aluminum, corrosion resistant
Stainless steel
NBR, conductive
-40 °C ... 125 °C
IP66 / IP68 (0.2 bar/24 h) / IP69K (ISO 20653:2013-02)
4 / 4X / 6P / 12

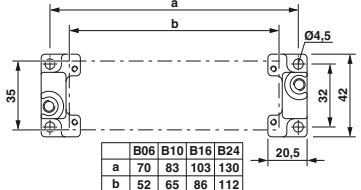
Ordering data

Description	Thread	Type	Order No.	Pcs. / Pkt.	Dimensions															
Sleeve housing¹⁾ Height: 74 mm 	1x M25	Cable outlet: top HC-ADV-B24-HLWH-1TTM25-EMC-AL	1414982	1																
Sleeve housing¹⁾ Height: 93.7 mm 	1x M25 1x M32 1x M40	Cable outlet: top HC-ADV-B24-HHWH-1TTM25-EMC-AL HC-ADV-B24-HHWH-1TTM32-EMC-AL HC-ADV-B24-HHWH-1TTM40-EMC-AL	1414980 1413430 1413432	1 1 1																
Sleeve housing¹⁾ Height: 74 mm 	1x M25	Cable outlet: lateral HC-ADV-B24-HLWH-1STM25-EMC-AL	1414983	1																
Sleeve housing¹⁾ Height: 93.7 mm 	1x M25 1x M32 1x M40	Cable outlet: lateral HC-ADV-B24-HHWH-1STM25-EMC-AL HC-ADV-B24-HHWH-1STM32-EMC-AL HC-ADV-B24-HHWH-1STM40-EMC-AL	1414981 1413431 1413433	1 1 1																
Panel mounting flange²⁾ 		2 pcs. per housing HC-B-AF Set with 2 panel mounting flanges HC-B-AF-SET	1686533 1604638	20 1	 <table border="1" data-bbox="1189 1533 1348 1585"> <thead> <tr> <th></th> <th>B06</th> <th>B10</th> <th>B16</th> <th>B24</th> </tr> </thead> <tbody> <tr> <td>a</td> <td>70</td> <td>83</td> <td>103</td> <td>130</td> </tr> <tr> <td>b</td> <td>52</td> <td>65</td> <td>86</td> <td>112</td> </tr> </tbody> </table>		B06	B10	B16	B24	a	70	83	103	130	b	52	65	86	112
	B06	B10	B16	B24																
a	70	83	103	130																
b	52	65	86	112																
Protective cover 		For sleeve side, IP50 HC-B 24-TMS-SD-IP50 For panel mounting side, IP66 HC-B 24-TMS-SD-IP66	1690765 1411520	10 10																

Notes:

In order to achieve optimum shielding results, the mounting surface must be conductive

Marking label: US-EMLP-HA (20X9), Order No. 0830989

¹⁾ Screw locking with M6 Allen screws

²⁾ Bore hole \varnothing 4.5 mm when using M4 screws, bore hole \varnothing 3.6 mm when using self-tapping M4 screws (Torx[®])

Accessories



Cable glands
From page 680



Box mounting base
phoenixcontact.net/products



Allen key
See Catalog 5



Replacement seals
From page 651

Heavy-duty connectors

HEAVYCON B - housing

Size B24, plastic, EVO housing, single locking latch









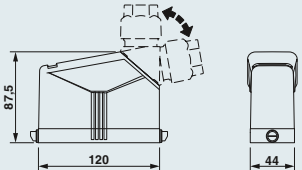

General data

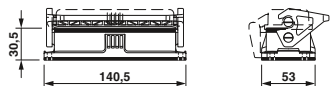
Housing material	Polyamide
Locking latch material	Polyamide
Sealing material	NBR
Ambient temperature (operation)	-40 °C ... 125 °C
IP degree of protection (when plugged in)	IP66
NEMA degree of protection (when plugged in)	4 / 4X / 12

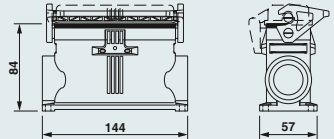
Technical data

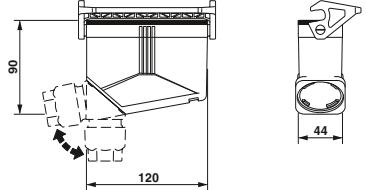
Ordering data

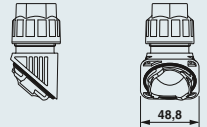
Description	Thread	Type	Order No.	Pcs. / Pkt.	Dimensions
Sleeve housing Height: 87.5 mm 		HC-EVO-B24-HHFS-PLBK	1407656	1	
Panel mounting base Height: 30.5 mm 		Without cover HC-EVO-B24-BWS-PLRBK With cover HC-EVO-B24-BWSC-PLRBK	1407659 1407660	1 1	
Box mounting base¹⁾ Height: 84 mm 	2x M40 2x M40	Without cover HC-EVO-B24-SHWS-2SSM40-PLRBK With cover HC-EVO-B24-SHWSC-2SSM40-PLRBK	1407663 1407664	1 1	
Coupling housing Height: 90 mm 		HC-EVO-B24-CHWS-PLRBK	1407667	1	
Cable gland 	Clamping area 7 mm ... 13 mm 9 mm ... 17 mm 11 mm ... 21 mm 19 mm ... 28 mm	HC-B-G-M20-PLRBK HC-B-G-M25-PLRBK HC-B-G-M32-PLRBK HC-B-G-M40-PLRBK	1407669 1407670 1407671 1407672	1 1 1 1	

Notes:

For further accessories, see page 642

Marking label: US-EMP (20X9) Order No. 0829439

¹⁾ One cable entry is sealed with a knockout cover

Accessories



EVO unlocking
From page 653



Thread adapter
From page 643



Replacement seals
From page 650



Connector set
From page 622









Size B24, metal, EVO housing, single locking latch

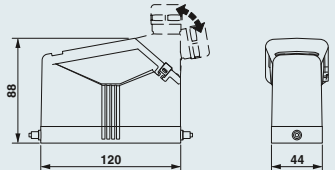

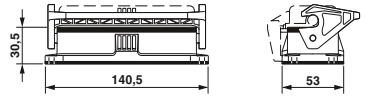
Technical data

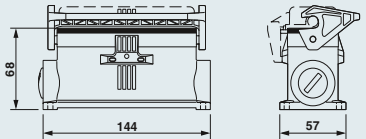
General data	
Housing material	Die-cast aluminum, corrosion resistant
Locking latch material	Polyamide
Sealing material	NBR, conductive
Ambient temperature (operation)	-40 °C ... 125 °C
IP degree of protection (when plugged in)	IP66 / IP69K (ISO 20653:2013-02)
NEMA degree of protection (when plugged in)	4 / 4X / 12

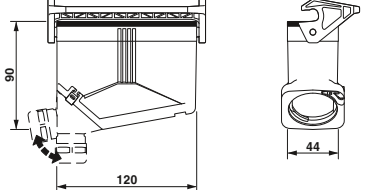
Ordering data

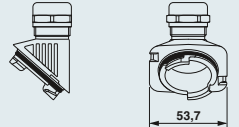
Description	Thread	Type	Order No.	Pcs. / Pkt.	Dimensions
Sleeve housing Height: 88 mm 		HC-EVO-B24-HHFS-EL-AL	1411473	1	
Panel mounting base Height: 30.5 mm 		Without cover HC-STA-B24-BWS-ELC-AL With cover HC-STA-B24-BWSC-ELC-AL	1411329 1411330	1 1	
Box mounting base¹⁾ Height: 68 mm 	2x M25 2x M32 2x Pg21	Without cover HC-STA-B24-SLWS-2SSM25-ELC-AL HC-STA-B24-SLWS-2SSM32-ELC-AL HC-STA-B24-SLWS-2SSP21-ELC-AL With cover HC-STA-B24-SLWSC-2SSM25-ELC-AL HC-STA-B24-SLWSC-2SSM32-ELC-AL HC-STA-B24-SLWSC-2SSP21-ELC-AL	1412877 1412878 1412879 1412881 1412882 1412883	1 1 1 1 1 1	
Coupling housing Height: 90 mm 		HC-EVO-B24-CHWS-ELC-AL	1411476	1	
Cable gland 	Clamping area 7 mm ... 13 mm 11 mm ... 16 mm 14 mm ... 21 mm 19 mm ... 27 mm	HC-B-G-M20-ER-AL HC-B-G-M25-ER-AL HC-B-G-M32-ER-AL HC-B-G-M40-ER-AL	1411442 1411443 1411444 1411445	1 1 1 1	

Notes:

- For further accessories, see page 642
- Marking label: US-EMLP-HA (20X9), Order No. 0830989
- ¹⁾ Supplied with a plastic sealing cap

Accessories



Thread adapter
From page 643



EMC cable gland
From page 642



Replacement seals
From page 650



Connector set
From page 623

Heavy-duty connectors

HEAVYCON B - housing

Size B24, metal, STANDARD sleeve housing for single locking latch

new







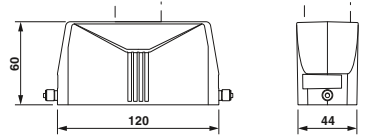

General data

Housing material
Locking latch material
Sealing material
Ambient temperature (operation)
IP degree of protection (when plugged in)
NEMA degree of protection (when plugged in)

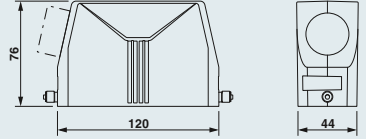
Technical data
Die-cast aluminum, corrosion resistant
-
-
-40 °C ... 125 °C
IP66 / IP69K (ISO 20653:2013-02)
4 / 4X / 12

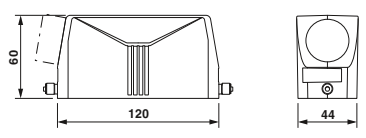
Ordering data

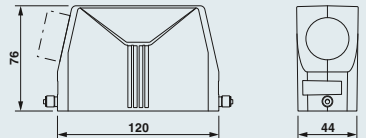
Description	Thread	Type	Order No.	Pcs. / Pkt.	Dimensions
Sleeve housing Height: 60 mm 	1x M25 1x M32	Cable outlet: top HC-STA-B24-HLFS-1TTM25-EL-AL	1412788	1	
		HC-STA-B24-HLFS-1TTM32-EL-AL	1412789	1	
	1x Pg16 1x Pg21 1x Pg29	HC-STA-B24-HLFS-1TTP16-EL-AL	1412790	1	
		HC-STA-B24-HLFS-1TTP21-EL-AL	1412791	1	
		HC-STA-B24-HLFS-1TTP29-EL-AL	1412792	1	
Sleeve housing Height: 76 mm 	1x M32 1x M40	Cable outlet: top HC-STA-B24-HHFS-1TTM32-EL-AL	1412761	1	
		HC-STA-B24-HHFS-1TTM40-EL-AL	1412098	1	
	1x Pg21 1x Pg29	HC-STA-B24-HHFS-1TTP21-EL-AL	1412762	1	
		HC-STA-B24-HHFS-1TTP29-EL-AL	1412763	1	
Sleeve housing Height: 60 mm 	1x M25 1x M32	Cable outlet: lateral HC-STA-B24-HLFS-1STM25-EL-AL	1412783	1	
		HC-STA-B24-HLFS-1STM32-EL-AL	1412784	1	
	1x Pg16 1x Pg21	HC-STA-B24-HLFS-1STP16-EL-AL	1412785	1	
		HC-STA-B24-HLFS-1STP21-EL-AL	1412786	1	
Sleeve housing Height: 76 mm 	1x M32 1x M40	Cable outlet: lateral HC-STA-B24-HHFS-1STM32-EL-AL	1412757	1	
		HC-STA-B24-HHFS-1STM40-EL-AL	1412758	1	
	1x Pg21 1x Pg29	HC-STA-B24-HHFS-1STP21-EL-AL	1412759	1	
		HC-STA-B24-HHFS-1STP29-EL-AL	1412760	1	

Notes:
For further accessories, see page 642
Marking label: US-EMLP-HA (20X9), Order No. 0830989

Accessories

 Cable glands From page 680	 Protective cover From page 646	 Cover plates From page 648	 Connector set From page 624
---	---	---	--







Size B24, metal, STANDARD supporting base element with single locking latch

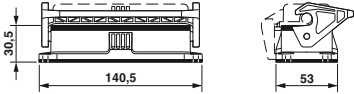

Technical data

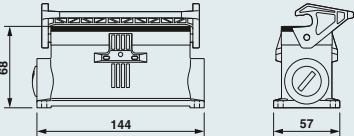
General data	
Housing material	Die-cast aluminum, corrosion resistant
Locking latch material	Polyamide
Sealing material	NBR, conductive
Ambient temperature (operation)	-40 °C ... 125 °C
IP degree of protection (when plugged in)	IP66 / IP69K (ISO 20653:2013-02)
NEMA degree of protection (when plugged in)	4 / 4X / 12

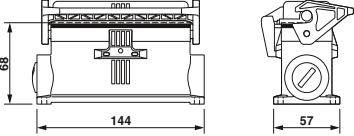
Ordering data

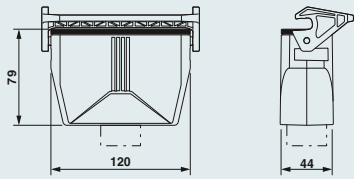
Description	Thread	Type	Order No.	Pcs. / Pkt.	Dimensions
Panel mounting base Height: 30.5 mm 		Without cover HC-STA-B24-BWS-ELC-AL	1411329	1	
		With cover HC-STA-B24-BWSC-ELC-AL	1411330	1	
Box mounting base¹⁾ Height: 68 mm 	2x M25 2x M32 2x Pg21	Without cover HC-STA-B24-SLWS-2SSM25-ELC-AL	1412877	1	
		HC-STA-B24-SLWS-2SSM32-ELC-AL	1412878	1	
		HC-STA-B24-SLWS-2SSP21-ELC-AL	1412879	1	
Box mounting base¹⁾ Height: 68 mm 	2x M25 2x M32 2x Pg21	With cover HC-STA-B24-SLWSC-2SSM25-ELC-AL	1412881	1	
		HC-STA-B24-SLWSC-2SSM32-ELC-AL	1412882	1	
		HC-STA-B24-SLWSC-2SSP21-ELC-AL	1412883	1	
Coupling housing Height: 77 mm 	1x M32 1x M40 1x Pg21 1x Pg29	Cable outlet: top HC-STA-B24-CHWS-1TTM32-ELC-AL	1412746	1	
		HC-STA-B24-CHWS-1TTM40-ELC-AL	1412747	1	
		HC-STA-B24-CHWS-1TTP21-ELC-AL	1412748	1	
		HC-STA-B24-CHWS-1TTP29-ELC-AL	1412749	1	

Notes:

- For further accessories, see page 642
- ¹⁾ Supplied with a plastic sealing cap

Accessories



Cable glands
From page 680



Replacement seals
From page 651



Replacement protective cover
From page 647



Replacement latch
From page 652

Heavy-duty connectors

HEAVYCON B - housing

Size B24, plastic, EVO housing, double locking latch











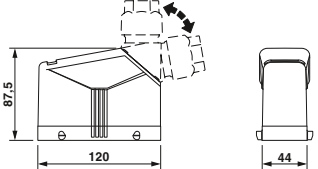

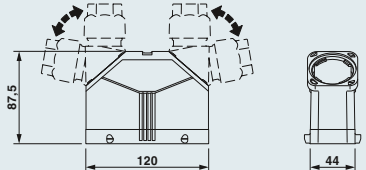
General data

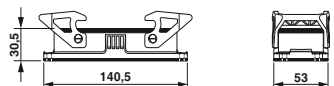
Housing material	Polyamide
Locking latch material	Polyamide
Sealing material	NBR
Ambient temperature (operation)	-40 °C ... 125 °C
IP degree of protection (when plugged in)	IP66
NEMA degree of protection (when plugged in)	4 / 4X / 12

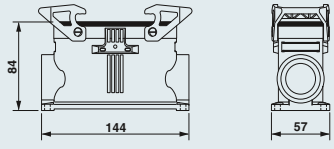
Technical data

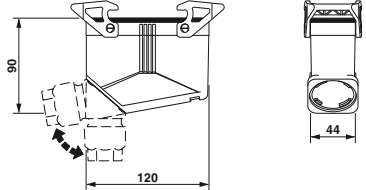
Ordering data

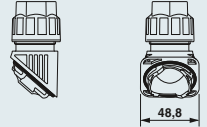
Description	Thread	Type	Order No.	Pcs. / Pkt.	Dimensions
Sleeve housing Height: 87.5 mm 		HC-EVO-B24-HHFD-PLBK	1407657	1	
Double sleeve housing Height: 87.5 mm 		HC-EVO-B24-HHFD-2B-PL-BK	1411497	1	
Panel mounting base Height: 30.5 mm 		Without cover HC-EVO-B24-BWD-PLRBK	1407661	1	
Box mounting base¹⁾ Height: 84 mm 	2x M40	Without cover HC-EVO-B24-SHWD-2SSM40-PLRBK	1407665	1	
Coupling housing Height: 90 mm 		HC-EVO-B24-CHWD-PLRBK	1407668	1	
Cable gland 	Clamping area 7 mm ... 13 mm 9 mm ... 17 mm 11 mm ... 21 mm 19 mm ... 28 mm	HC-B-G-M20-PLRBK HC-B-G-M25-PLRBK HC-B-G-M32-PLRBK HC-B-G-M40-PLRBK	1407669 1407670 1407671 1407672	1 1 1 1	

Notes:

For further accessories, see page 642

Marking label: US-EMP (20X9) Order No. 0829439

¹⁾ One cable entry is sealed with a knockout cover

Accessories



EVO unlocking
From page 653



Thread adapter
From page 643



Replacement seals
From page 650



Connector set
From page 622









Size B24, metal, EVO housing, double locking latch

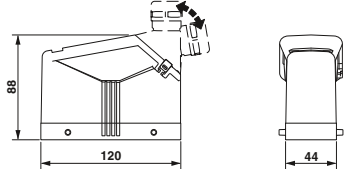

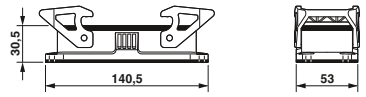
Technical data

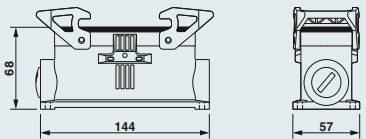
General data	
Housing material	Die-cast aluminum, corrosion resistant
Locking latch material	Polyamide
Sealing material	NBR, conductive
Ambient temperature (operation)	-40 °C ... 125 °C
IP degree of protection (when plugged in)	IP66 / IP69K (ISO 20653:2013-02)
NEMA degree of protection (when plugged in)	4 / 4X / 12

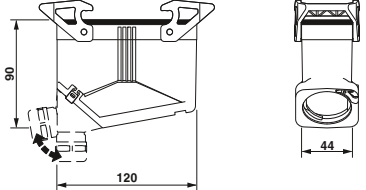
Ordering data

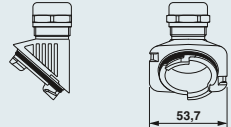
Description	Thread	Type	Order No.	Pcs. / Pkt.	Dimensions
Sleeve housing Height: 88 mm 		HC-EVO-B24-HHFD-EL-AL	1411472	1	
Panel mounting base Height: 30.5 mm 		Without cover HC-STA-B24-BWD-ELC-AL	1411331	1	
Box mounting base¹⁾ Height: 68 mm 	2x M25 2x M32 2x Pg21	Without cover HC-STA-B24-SLWD-2SSM25-ELC-AL HC-STA-B24-SLWD-2SSM32-ELC-AL HC-STA-B24-SLWD-2SSP21-ELC-AL	1412873 1412874 1412875	1 1 1	
Coupling housing Height: 90 mm 		HC-EVO-B24-CHWD-ELC-AL	1411475	1	
Cable gland 	Clamping area 7 mm ... 13 mm 11 mm ... 16 mm 14 mm ... 21 mm 19 mm ... 27 mm	HC-B-G-M20-ER-AL HC-B-G-M25-ER-AL HC-B-G-M32-ER-AL HC-B-G-M40-ER-AL	1411442 1411443 1411444 1411445	1 1 1 1	

Notes:

- For further accessories, see page 642
- Marking label: US-EMLP-HA (20X9), Order No. 0830989
- ¹⁾ Supplied with a plastic sealing cap

Accessories



Thread adapter
From page 643



EMC cable gland
From page 642



Replacement seals
From page 650



Connector set
From page 623

Heavy-duty connectors

HEAVYCON B - housing

Size B24, metal, STANDARD sleeve housing for double locking latch

new







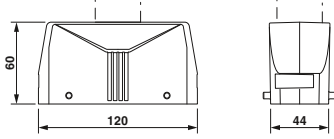

General data

Housing material
Locking latch material
Sealing material
Ambient temperature (operation)
IP degree of protection (when plugged in)
NEMA degree of protection (when plugged in)

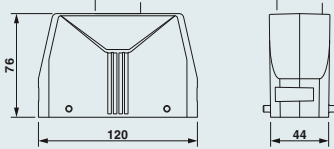
Technical data
Die-cast aluminum, corrosion resistant
-
-
-40 °C ... 125 °C
IP66 / IP69K (ISO 20653:2013-02)
4 / 4X / 12

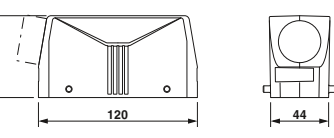
Ordering data

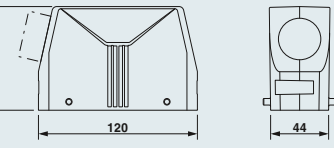
Description	Thread	Type	Order No.	Pcs. / Pkt.	Dimensions
Sleeve housing Height: 60 mm 	1x M25 1x M32	Cable outlet: top HC-STA-B24-HLFD-1TTM25-EL-AL	1412778	1	
		HC-STA-B24-HLFD-1TTM32-EL-AL	1412779	1	
	1x Pg16 1x Pg21 1x Pg29	HC-STA-B24-HLFD-1TTP16-EL-AL	1412780	1	
		HC-STA-B24-HLFD-1TTP21-EL-AL	1412781	1	
		HC-STA-B24-HLFD-1TTP29-EL-AL	1412782	1	
Sleeve housing Height: 76 mm 	1x M32 1x M40	Cable outlet: top HC-STA-B24-HHFD-1TTM32-EL-AL	1412754	1	
		HC-STA-B24-HHFD-1TTM40-EL-AL	1412099	1	
	1x Pg21 1x Pg29	HC-STA-B24-HHFD-1TTP21-EL-AL	1412755	1	
		HC-STA-B24-HHFD-1TTP29-EL-AL	1412756	1	
Sleeve housing Height: 60 mm 	1x M25 1x M32	Cable outlet: lateral HC-STA-B24-HLFD-1STM25-EL-AL	1412773	1	
		HC-STA-B24-HLFD-1STM32-EL-AL	1412774	1	
	1x Pg16 1x Pg21	HC-STA-B24-HLFD-1STP16-EL-AL	1412775	1	
		HC-STA-B24-HLFD-1STP21-EL-AL	1412776	1	
Sleeve housing Height: 76 mm 	1x M32 1x M40	Cable outlet: lateral HC-STA-B24-HHFD-1STM32-EL-AL	1412750	1	
		HC-STA-B24-HHFD-1STM40-EL-AL	1412751	1	
	1x Pg21 1x Pg29	HC-STA-B24-HHFD-1STP21-EL-AL	1412752	1	
		HC-STA-B24-HHFD-1STP29-EL-AL	1412753	1	

Notes:
For further accessories, see page 642
Marking label: US-EMLP-HA (20X9), Order No. 0830989

Accessories

 Cable glands From page 680	 Protective cover From page 646	 Cover plates From page 648	 Connector set From page 624
---	---	---	--

new





Size B24, metal, STANDARD base element with double locking latch

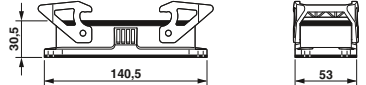

Technical data

General data	
Housing material	Die-cast aluminum, corrosion resistant
Locking latch material	Polyamide
Sealing material	NBR, conductive
Ambient temperature (operation)	-40 °C ... 125 °C
IP degree of protection (when plugged in)	IP66 / IP69K (ISO 20653:2013-02)
NEMA degree of protection (when plugged in)	4 / 4X / 12

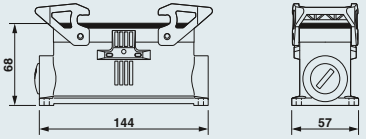
Ordering data

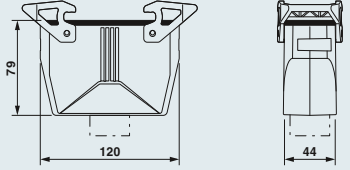
Description	Thread	Type	Order No.	Pcs. / Pkt.	Dimensions
Panel mounting base Height: 30.5 mm 		Without cover HC-STA-B24-BWD-ELC-AL	1411331	1	
Box mounting base¹⁾ Height: 68 mm 	2x M25 2x M32 2x Pg21	Without cover HC-STA-B24-SLWD-2SSM25-ELC-AL HC-STA-B24-SLWD-2SSM32-ELC-AL HC-STA-B24-SLWD-2SSP21-ELC-AL	1412873 1412874 1412875	1 1 1	
Coupling housing Height: 77 mm 	1x M32 1x M40 1x Pg21 1x Pg29	Cable outlet: top HC-STA-B24-CHWD-1TTM32-ELC-AL HC-STA-B24-CHWD-1TTM40-ELC-AL HC-STA-B24-CHWD-1TTP21-ELC-AL HC-STA-B24-CHWD-1TTP29-ELC-AL	1412742 1412743 1412744 1412745	1 1 1 1	

Notes:

- For further accessories, see page 642
- ¹⁾ Supplied with a plastic sealing cap

Accessories



Cable glands
From page 680



Replacement seals
From page 651



Replacement protective cover
From page 647



Replacement latch
From page 652

Heavy-duty connectors

HEAVYCON B - housing

Size B24, plastic, EVO housing, double locking latch



General data

Housing material	Polyamide
Locking latch material	Polyamide
Sealing material	NBR
Ambient temperature (operation)	-40 °C ... 125 °C
IP degree of protection (when plugged in)	IP66
NEMA degree of protection (when plugged in)	4 / 4X / 12

Technical data

Ordering data

Description

Thread

Type

Order No.

Pcs. / Pkt.

Dimensions

Sleeve housing Height: 87.5 mm



HC-EVO-B24-HHWD-PLBK

1407658

1

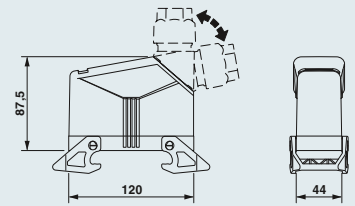

Panel mounting base Height: 30.5 mm



With cover
HC-EVO-B24-BFDC-PLRBK

1407662

1

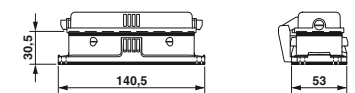

Box mounting base¹⁾ Height: 84 mm

2x M40



With cover
HC-EVO-B24-SHFDC-2SSM40-PLRBK

1407666

1

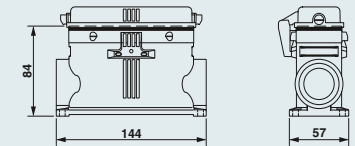

Cable gland

Clamping area

7 mm ... 13 mm
9 mm ... 17 mm
11 mm ... 21 mm
19 mm ... 28 mm



HC-B-G-M20-PLRBK
HC-B-G-M25-PLRBK
HC-B-G-M32-PLRBK
HC-B-G-M40-PLRBK

1407669
1407670
1407671
1407672

1
1
1
1

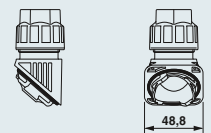

Notes:

For further accessories, see from page 642

Marking label: US-EMP (20X9) Order No. [0829439](#)

¹⁾ One cable entry is sealed with a knockout cover

Accessories



EVO unlocking
From page 653



Thread adapter
From page 643



Replacement seals
From page 650



Replacement latch
From page 652







Size B24, metal, EVO housing, double locking latch

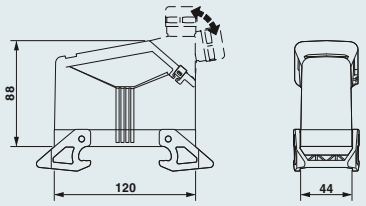

Technical data

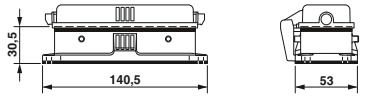
General data	
Housing material	Die-cast aluminum, corrosion resistant
Locking latch material	Polyamide
Sealing material	NBR, conductive
Ambient temperature (operation)	-40 °C ... 125 °C
IP degree of protection (when plugged in)	IP66 / IP69K (ISO 20653:2013-02)
NEMA degree of protection (when plugged in)	4 / 4X / 12

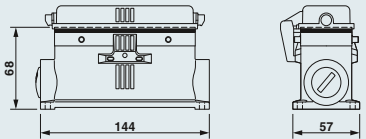
Ordering data

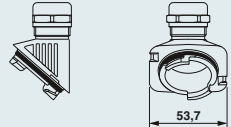
Description	Thread	Type	Order No.	Pcs. / Pkt.	Dimensions
Sleeve housing Height: 88 mm 		HC-EVO-B24-HHWD-EL-AL	1411474	1	
Panel mounting base Height: 30.5 mm 		With cover HC-STA-B24-BFDC-ELC-AL	1411332	1	
Box mounting base¹⁾ Height: 68 mm 	2x M25 2x M32 2x Pg21	With cover HC-STA-B24-SLFDC-2SSM25-ELC-AL HC-STA-B24-SLFDC-2SSM32-ELC-AL HC-STA-B24-SLFDC-2SSP21-ELC-AL	1412869 1412870 1412871	1 1 1	
Cable gland 	Clamping area 7 mm ... 13 mm 11 mm ... 16 mm 14 mm ... 21 mm 19 mm ... 27 mm	HC-B-G-M20-ER-AL HC-B-G-M25-ER-AL HC-B-G-M32-ER-AL HC-B-G-M40-ER-AL	1411442 1411443 1411444 1411445	1 1 1 1	

Notes:

- For further accessories, see page 642
- Marking label: US-EMLP-HA (20X9), Order No. 0830989
- ¹⁾ Supplied with a plastic sealing cap

Accessories



Thread adapter
From page 643



EMC cable gland
From page 642



Replacement seals
From page 650



Replacement latch
From page 652

Heavy-duty connectors

HEAVYCON B - housing

Size B24, metal, STANDARD sleeve housing with double locking latch

new







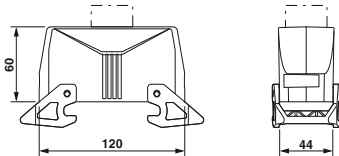

General data

Housing material
Locking latch material
Sealing material
Ambient temperature (operation)
IP degree of protection (when plugged in)
NEMA degree of protection (when plugged in)

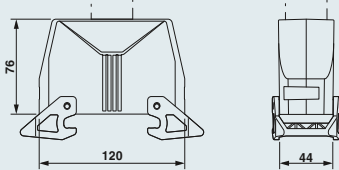
Technical data
Die-cast aluminum, corrosion resistant
PA
-
-40 °C ... 125 °C
IP66 / IP69K (ISO 20653:2013-02)
4 / 4X / 12

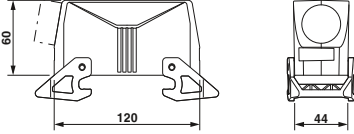
Ordering data

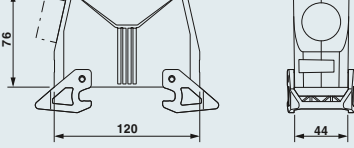
Description	Thread	Type	Order No.	Pcs. / Pkt.	Dimensions
Sleeve housing Height: 60 mm 	1x M25 1x M32	Cable outlet: top HC-STA-B24-HLWD-1TTM25-EL-AL	1412799	1	
		HC-STA-B24-HLWD-1TTM32-EL-AL	1412800	1	
	1x Pg16 1x Pg21 1x Pg29	HC-STA-B24-HLWD-1TTP16-EL-AL	1412801	1	
		HC-STA-B24-HLWD-1TTP21-EL-AL	1412802	1	
		HC-STA-B24-HLWD-1TTP29-EL-AL	1412803	1	
Sleeve housing Height: 76 mm 	1x M32 1x M40	Cable outlet: top HC-STA-B24-HHWD-1TTM32-EL-AL	1412769	1	
		HC-STA-B24-HHWD-1TTM40-EL-AL	1412770	1	
	1x Pg21 1x Pg29	HC-STA-B24-HHWD-1TTP21-EL-AL	1412771	1	
		HC-STA-B24-HHWD-1TTP29-EL-AL	1412772	1	
Sleeve housing Height: 60 mm 	1x M25 1x M32	Cable outlet: lateral HC-STA-B24-HLWD-1STM25-EL-AL	1412793	1	
		HC-STA-B24-HLWD-1STM32-EL-AL	1412795	1	
	1x Pg16 1x Pg21	HC-STA-B24-HLWD-1STP16-EL-AL	1412796	1	
		HC-STA-B24-HLWD-1STP21-EL-AL	1412797	1	
Sleeve housing Height: 76 mm 	1x M32 1x M40	Cable outlet: lateral HC-STA-B24-HHWD-1STM32-EL-AL	1412764	1	
		HC-STA-B24-HHWD-1STM40-EL-AL	1412766	1	
	1x Pg21 1x Pg29	HC-STA-B24-HHWD-1STP21-EL-AL	1412767	1	
		HC-STA-B24-HHWD-1STP29-EL-AL	1412768	1	

Notes:
For further accessories, see page 642
Marking label: US-EMLP-HA (20X9), Order No. 0830989

Accessories



 Cable glands From page 680	 Protective cover From page 646	 Replacement latch From page 652
---	---	--

**Size B24, metal,
STANDARD supporting base element
for double locking latch**



General data	
Housing material	Aluminum die-cast
Locking latch material	-
Sealing material	NBR, conductive
Ambient temperature (operation)	-40 °C ... 125 °C
IP degree of protection (when plugged in)	IP66 / IP69K (ISO 20653:2013-02)
NEMA degree of protection (when plugged in)	4 / 4X / 12

Technical data	
Housing material	Aluminum die-cast
Locking latch material	-
Sealing material	NBR, conductive
Ambient temperature (operation)	-40 °C ... 125 °C
IP degree of protection (when plugged in)	IP66 / IP69K (ISO 20653:2013-02)
NEMA degree of protection (when plugged in)	4 / 4X / 12

Ordering data				
Description	Thread	Type	Order No.	Pcs. / Pkt.
Panel mounting base Height: 30.5 mm 		With cover HC-STA-B24-BFDC-ELC-AL	1411332	1
		Box mounting base¹⁾ Height: 68 mm 	2x M25 2x M32 2x Pg21	With cover HC-STA-B24-SLFDC-2SSM25-ELC-AL HC-STA-B24-SLFDC-2SSM32-ELC-AL HC-STA-B24-SLFDC-2SSP21-ELC-AL

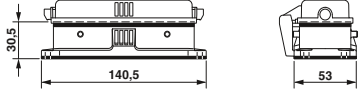
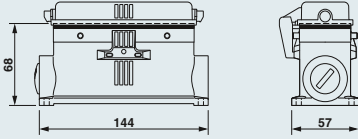
Dimensions	
	

Notes:
For further accessories, see page 642
¹⁾ Supplied with a plastic sealing cap

Accessories

 Cable glands From page 680	 Replacement seals From page 651	 Replacement protective cover From page 647	 Cover plates From page 648
---	--	---	---

Heavy-duty connectors

HEAVYCON B - housing

Size B32, metal,
ADVANCE sleeve housing,
Offshore/EMC







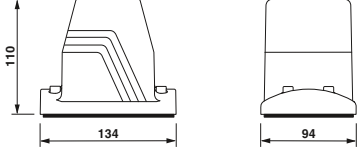

General data

Housing material
Lock material
Sealing material
Ambient temperature (operation)
IP degree of protection (when plugged in)
NEMA degree of protection (when plugged in)

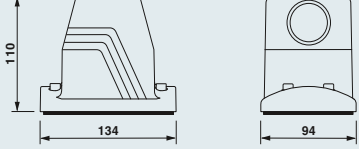
Technical data
Die-cast aluminum, salt water resistant
Stainless steel
NBR, conductive
-40 °C ... 125 °C
IP66 / IP68 (0.2 bar 24 h) / IP69K
4 / 4X / 6P / 12

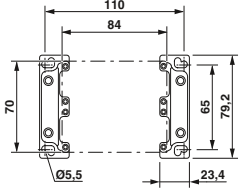
Ordering data

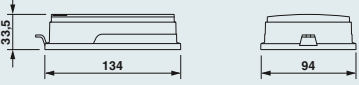
Description	Thread	Type	Order No.	Pcs. / Pkt.	Dimensions
Sleeve housing¹⁾ Height: 110 mm 	1x M32 1x M40 1x M50	Cable outlet: top HC-B 32-TMS-100-O1STM32G-EEE HC-B 32-TMS-100-O1STM40G-EEE HC-B 32-TMS-100-O1STM50G-EEE	1580516 1580518 1580522	6 6 6	
Sleeve housing¹⁾ Height: 110 mm 	1x M32 1x M40 1x M50	Cable outlet: lateral HC-B 32-TMS-100-O1STM32S-EEE HC-B 32-TMS-100-O1STM40S-EEE HC-B 32-TMS-100-O1STM50S-EEE	1580517 1580519 1580521	6 6 6	
Panel mounting flange²⁾ 		2 pcs. per housing HC-B 32/48-AF Set with 2 panel mounting flanges HC-B 32/48-AF-SET	1580524 1580523	20 1	
IP65 protective cover 		HC-B 32-TMS-SD-IP65	1580539	6	

Notes:
In order to achieve optimum shielding results, the mounting surface must be conductive
Marking label: US-EMLP-HA (20X9), Order No. 0830989
¹⁾ Screw locking with M6 Allen screws
²⁾ Bore hole Ø 5.5 mm when using M4 screws, bore hole Ø 4.5 mm when using self-tapping M5 screws (Torx®)

Accessories



Cable glands
From page 680



Box mounting base
phoenixcontact.net/products



Allen key
See Catalog 5

Size B32, metal, housing, double locking latch

General data







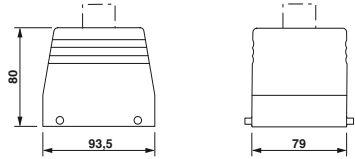

Housing material
Locking latch material
Sealing material
Ambient temperature (operation)
IP degree of protection (when plugged in)

Technical data

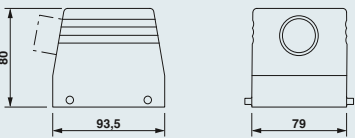
Aluminum die-cast
Steel, galvanized
NBR
-40 °C ... 125 °C
IP65

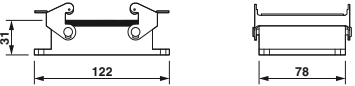

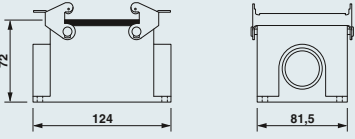
Ordering data

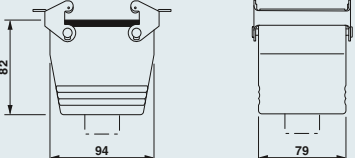
Description	Thread	Type	Order No.	Pcs. / Pkt.	Dimensions
Sleeve housing Height: 80 mm 	1x M32 1x M40 1x M50 1x Pg29 1x Pg36	Cable outlet: top HC-B 32-TFQ-80/O1STM32G HC-B 32-TFQ-80/O1STM40G HC-B 32-TFQ-80/O1STM50G HC-B 32-TFQ-80/O1PG29G HC-B 32-TFQ-80/O1PG36G	1645383 1647307 1460197 1675081 1460138	10 10 10 10 10	
Sleeve housing Height: 80 mm 	1x M32 1x M40 1x M50 1x Pg29 1x Pg36	Cable outlet: lateral HC-B 32-TFQ-80/O1STM32S HC-B 32-TFQ-80/O1STM40S HC-B 32-TFQ-80/O1STM50S HC-B 32-TFQ-80/O1PG29S HC-B 32-TFQ-80/O1PG36S	1645150 1645451 1585980 1675094 1644818	10 10 10 10 10	
Panel mounting base Height: 31 mm 		Without cover HC-B 32-AMQ	1775693	10	
Box mounting base Height: 72 mm 	1x M32 2x M32 2x M40 1x Pg29 2x Pg29	Without cover HC-B 32-SMQ-72/O1M32 HC-B 32-SMQ-72/O1PG29 HC-B 32-SMQ-72/O2M32 HC-B 32-SMQ-72/O2M40 HC-B 32-SMQ-72/O2PG29	1604867 1675036 1604868 1604869 1675049	10 10 10 10 10	
Coupling housing Height: 82 mm 	1x M32 1x M40 1x Pg21 1x Pg29	Cable outlet: top HC-B 32-KMQ-82/O1STM32 HC-B 32-KMQ-82/O1STM40 HC-B 32-KMQ-82/O1PG21 HC-B 32-KMQ-82/O1PG29	1647284 1647297 1675010 1675023	10 10 10 10	

Notes:

For further accessories, see page 642

Accessories



Cable glands
From page 680



Flat gaskets
From page 651



Cover plates
From page 648

Heavy-duty connectors

HEAVYCON B - housing

**Size B48, metal,
housing,
single locking latch**







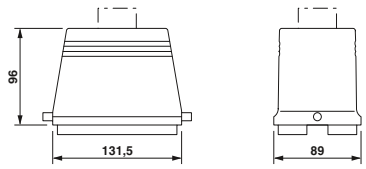

General data

Housing material
Locking latch material
Sealing material
Ambient temperature (operation)
IP degree of protection (when plugged in)

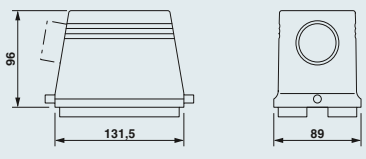
Technical data
Aluminum die-cast
Steel, galvanized
NBR
-40 °C ... 125 °C
IP65

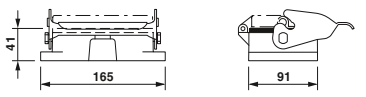

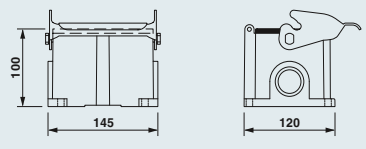
Ordering data

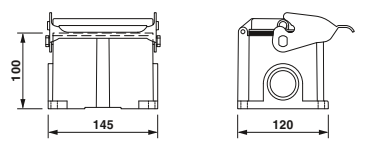
Description	Thread	Type	Order No.	Pcs. / Pkt.	Dimensions	
Sleeve housing Height: 96 mm 	1x M32	Cable outlet: top	HC-B 48-TFL-96/O1STM32G	1		
	1x M40		HC-B 48-TFL-96/O1STM40G	1		
	1x M50		HC-B 48-TFL-96/O1STM50G	10		
		1x Pg29		HC-B 48-TFL-96/O1PG29G		1
		1x Pg36		HC-B 48-TFL-96/O1PG36G		1
				HC-B 48-TFL-96/O1PG36S		1
Sleeve housing Height: 96 mm 	1x M32	Cable outlet: lateral	HC-B 48-TFL-96/O1STM32S	1		
	1x M40		HC-B 48-TFL-96/O1STM40S	1		
	1x M50		HC-B 48-TFL-96/O1STM50S	10		
		1x Pg29		HC-B 48-TFL-96/O1PG29S		1
		1x Pg36		HC-B 48-TFL-96/O1PG36S		1
				HC-B 48-TFL-96/O1PG36S		1
Panel mounting base Height: 41 mm 		Without cover	HC-B 48-AML	1		
		With cover	HC-B 48-AML	1		
Box mounting base Height: 100 mm 	1x M32	Without cover	HC-B 48-SML-100/O1M32	1		
			HC-B 48-SML-100/O1PG29	1		
	2x M32	1x Pg29		HC-B 48-SML-100/O2M32		10
	2x M40			HC-B 48-SML-100/O2M40		1
		2x Pg29		HC-B 48-SML-100/O2PG29		1
		2x Pg36		HC-B 48-SML-100/O2PG36		10
				HC-B 48-SML-100/O2PG36		10
Box mounting base Height: 100 mm 	1x M32	With cover	HC-B 48-SMLD-100/O1M32	1		
	2x M40		HC-B 48-SMLD-100/O2M40	1		
		2x Pg36		HC-B 48-SMLD-100/O2M40		10
				HC-B 48-SMLD-100/O2PG36		10

Notes:
For further accessories, see page 642

Accessories

 Cable glands From page 680	 Flat gaskets From page 651	 Cover plates From page 648
---	---	---

Heavy-duty connectors

HEAVYCON B - housing

Connector sets, EVO housing, plastic, push-in connection

General data



Housing material
Sealing material
Inflammability class in acc. with UL 94
Insertion/withdrawal cycles
Ambient temperature (operation)
IP degree of protection (when plugged in)
NEMA degree of protection (when plugged in)

Technical data

Polyamide
NBR
V0
≥ 500
-40 °C ... 125 °C
IP66
4 / 4X / 12



Ordering data

Description	Pos.	Size	Type	Order No.	Pcs. / Pkt.	Dimensions
Connector set 	6	B6	Single locking latch, with cover HC-EVO-B06PT-BWSC-HL-M20-PLRBK	1407710	1	
Connector set 	10	B10	Single locking latch, with cover HC-EVO-B10PT-BWSC-HL-M25-PLRBK	1408791	1	
	10	B10	Double locking latch, without cover HC-EVO-B10PT-BWD-HL-M25-PLRBK	1407711	1	
Connector set 	16	B16	Single locking latch, with cover HC-EVO-B16PT-BWSC-HH-M25-PLRBK	1408793	1	
	16	B16	Double locking latch, without cover HC-EVO-B16PT-BWD-HH-M25-PLRBK	1407712	1	
Connector set 	24	B24	Single locking latch, with cover HC-EVO-B24PT-BWSC-HH-M32-PLRBK	1408794	1	
	24	B24	Double locking latch, without cover HC-EVO-B24PT-BWD-HH-M32-PLRBK	1407713	1	
Sample kit 			CASE HC EVO OVERVIEW	5053053	1	

Notes:

For further accessories, see page 634

Only operate connectors when there is no load/the power is switched off

For assembly instructions, see phoenixcontact.net/products

Accessories



EVO unlocking
From page 653



Replacement latch
From page 652



Replacement seals
From page 650

Connector sets, EVO housing, metal, push-in connection



General data

Housing material
Sealing material
Inflammability class in acc. with UL 94
Insertion/withdrawal cycles
Ambient temperature (operation)
IP degree of protection (when plugged in)
NEMA degree of protection (when plugged in)

Technical data

Die-cast aluminum, corrosion resistant
NBR, conductive
V0
≥ 500
-40 °C ... 125 °C
IP66 / IP69K (ISO 20653:2013-02)
4 / 4X / 12

Ordering data

Description	Pos.	Size	Type	Order No.	Pcs. / Pkt.	Dimensions
Connector set 	6	B6	Single locking latch, with cover HC-EVO-B06PT-BWSC-HL-M20ELC-AL	1411487	1	
Connector set 	10	B10	Single locking latch, with cover HC-EVO-B10PT-BWSC-HL-M25ELC-AL	1411491	1	
	10	B10	Double locking latch, without cover HC-EVO-B10PT-BWD-HL-M25ELC-AL	1411488	1	
Connector set 	16	B16	Single locking latch, with cover HC-EVO-B16PT-BWSC-HH-M25ELC-AL	1411492	1	
	16	B16	Double locking latch, without cover HC-EVO-B16PT-BWD-HH-M25ELC-AL	1411489	1	
Connector set 	24	B24	Single locking latch, with cover HC-EVO-B24PT-BWSC-HH-M32ELC-AL	1411493	1	
	24	B24	Double locking latch, without cover HC-EVO-B24PT-BWD-HH-M32ELC-AL	1411490	1	
Sample kit 			CASE HC EVO OVERVIEW	5053053	1	

Notes:

For further accessories, see page 634
Only operate connectors when there is no load/the power is switched off
For assembly instructions, see phoenixcontact.net/products

Accessories



Replacement latch
From page 652



Replacement seals
From page 650

Heavy-duty connectors

HEAVYCON B - housing

Connector sets, STANDARD housing, metal, push-in connection

new







General data

Housing material
Sealing material
Inflammability class in acc. with UL 94
Insertion/withdrawal cycles
Ambient temperature (operation)
IP degree of protection (when plugged in)
NEMA degree of protection (when plugged in)

Technical data

Aluminum, corrosion resistant
NBR
V0
≥ 500
-40 °C ... 125 °C
IP66 / IP69K (ISO 20653:2013-02)
4 / 4X / 12

Ordering data

Description	Pos.	Size	Type	Order No.	Pcs. / Pkt.	Dimensions
Connector set, cable outlet: top 	6	B6	Single locking latch, with cover HC-STA-B06PT-BWSC-LT-M20-ELCAL	1416344	1	
Connector set, cable outlet: top 	10	B10	Single locking latch, with cover HC-STA-B10PT-BWSC-LT-M25-ELCAL	1416345	1	
	10	B10	Double locking latch, without cover HC-STA-B10PT-BWD-LT-M25-ELCAL	1416346	1	
Connector set, cable outlet: top 	16	B16	Single locking latch, with cover HC-STA-B16PT-BWSC-LT-M25-ELCAL	1416348	1	
	16	B16	Double locking latch, without cover HC-STA-B16PT-BWD-LT-M25-ELCAL	1416349	1	
Connector set, cable outlet: top 	24	B24	Single locking latch, with cover HC-STA-B24PT-BWSC-LT-M32-ELCAL	1416351	1	
	24	B24	Double locking latch, without cover HC-STA-B24PT-BWD-LT-M32-ELCAL	1416352	1	

Notes:
For further accessories, see page 634
Only operate connectors when there is no load/the power is switched off
For assembly instructions, see phoenixcontact.net/products

Accessories



Replacement latch
From page 652



Replacement seals
From page 650

new

Connector sets, STANDARD housing, metal, push-in connection







General data	
Housing material	Die-cast aluminum, corrosion resistant
Sealing material	NBR
Inflammability class in acc. with UL 94	V0
Insertion/withdrawal cycles	≥ 500
Ambient temperature (operation)	-40 °C ... 125 °C
IP degree of protection (when plugged in)	IP66 / IP69K (ISO 20653:2013-02)
NEMA degree of protection (when plugged in)	4 / 4X / 12

Technical data

Housing material	Die-cast aluminum, corrosion resistant
Sealing material	NBR
Inflammability class in acc. with UL 94	V0
Insertion/withdrawal cycles	≥ 500
Ambient temperature (operation)	-40 °C ... 125 °C
IP degree of protection (when plugged in)	IP66 / IP69K (ISO 20653:2013-02)
NEMA degree of protection (when plugged in)	4 / 4X / 12

Ordering data

Description	Pos.	Size	Type	Order No.	Pcs. / Pkt.	Dimensions
Connector set, cable outlet: lateral 	6	B6	Single locking latch, with cover HC-STA-B06PT-BWSC-LS-M20-ELCAL	1416353	1	
Connector set, cable outlet: lateral 	10	B10	Single locking latch, with cover HC-STA-B10PT-BWSC-LS-M25-ELCAL	1416354	1	
	10	B10	Double locking latch, without cover HC-STA-B10PT-BWD-LS-M25-ELCAL	1416355	1	
Connector set, cable outlet: lateral 	16	B16	Single locking latch, with cover HC-STA-B16PT-BWSC-LS-M25-ELCAL	1416356	1	
	16	B16	Double locking latch, without cover HC-STA-B16PT-BWD-LS-M25-ELCAL	1416357	1	
Connector set, cable outlet: lateral 	24	B24	Single locking latch, with cover HC-STA-B24PT-BWSC-LS-M32-ELCAL	1416358	1	
	24	B24	Double locking latch, without cover HC-STA-B24PT-BWD-LS-M32-ELCAL	1416359	1	

Notes:

For further accessories, see page 634

Only operate connectors when there is no load/the power is switched off

For assembly instructions, see phoenixcontact.net/products

Accessories



Replacement latch
From page 652



Replacement seals
From page 650

Heavy-duty connectors

HEAVYCON B - housing

**Size B6, metal,
housing for railway applications,
screw locking**







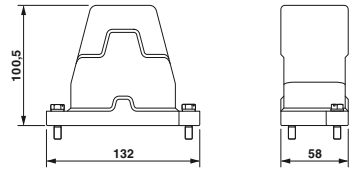

General data

Housing material
Surface material
Lock material
Sealing material
Ambient temperature (operation)
IP degree of protection (when plugged in)

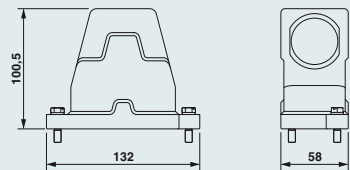
Technical data
Aluminum die-cast
Powder-coated, black
Stainless steel
NBR
-40 °C ... 125 °C
IP68 (0.5 bar, 24 h) / IP69K

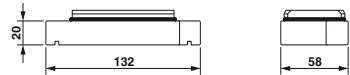
Ordering data

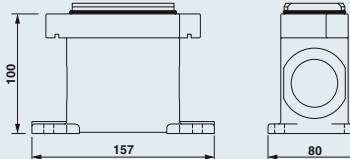
Description	Thread	Type	Order No.	Pcs. / Pkt.	Dimensions
Sleeve housing Height: 100.5 mm 	1x M20 1x M25	Cable outlet: top HC-HPR-B06-HHWH-1TTM20-EM-BK HC-HPR-B06-HHWH-1TTM25-EM-BK	1411879	1	
			1411106	1	
Sleeve housing Height: 100.5 mm 	1x M20 1x M25	Cable outlet: lateral HC-HPR-B06-HHWH-1STM20-EM-BK HC-HPR-B06-HHWH-1STM25-EM-BK	1411878	1	
			1411119	1	
Panel mounting base Height: 20 mm 		Without cover HC-HPR-B06-BFH-EMR-BK	1411122	1	
Box mounting base Height: 100 mm 	2x M20 2x M25	Without cover HC-HPR-B06-SHFH-2SSM20-EMR-BK HC-HPR-B06-SHFH-2SSM25-EMR-BK	1411880	1	
			1411135	1	

Accessories









Cable glands
From page 680

**Size B10, metal,
housing for railway applications,
screw locking**

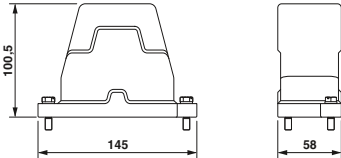

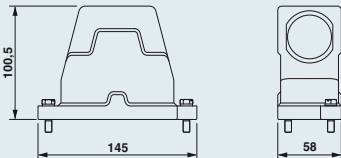
General data	
Housing material	Aluminum die-cast
Surface material	Powder-coated, black
Lock material	Stainless steel
Sealing material	NBR
Ambient temperature (operation)	-40 °C ... 125 °C
IP degree of protection (when plugged in)	IP68 (0.5 bar, 24 h) / IP69K

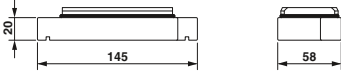
Technical data	
Housing material	Aluminum die-cast
Surface material	Powder-coated, black
Lock material	Stainless steel
Sealing material	NBR
Ambient temperature (operation)	-40 °C ... 125 °C
IP degree of protection (when plugged in)	IP68 (0.5 bar, 24 h) / IP69K

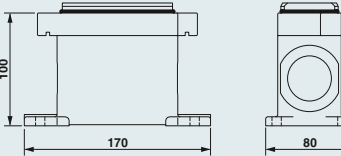
Description		Thread	Type	Order No.	Pcs. / Pkt.	Dimensions
Sleeve housing Height: 100.5 mm 	1x M25 1x M32	Cable outlet: top HC-HPR-B10-HHWH-1TTM25-EM-BK HC-HPR-B10-HHWH-1TTM32-EM-BK	1411882	1		
			1411067	1		
Sleeve housing Height: 100.5 mm 	1x M25 1x M32	Cable outlet: lateral HC-HPR-B10-HHWH-1STM25EM-BK HC-HPR-B10-HHWH-1STM32-EM-BK	1411881	1		
			1411070	1		
Panel mounting base Height: 20 mm 		Without cover HC-HPR-B10-BFH-EMR-BK	1411083	1		
Box mounting base Height: 100 mm 	2x M25 2x M32	Without cover HC-HPR-B10-SHFH-2SSM25-EMR-BK HC-HPR-B10-SHFH-2SSM32-EMR-BK	1411883	1		
			1411096	1		

Accessories



Cable glands
From page 680

Heavy-duty connectors

HEAVYCON B - housing

**Size B16, metal,
housing for railway applications,
screw locking**







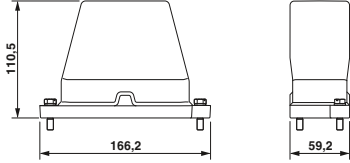

General data

Housing material
Surface material
Lock material
Sealing material
Ambient temperature (operation)
IP degree of protection (when plugged in)

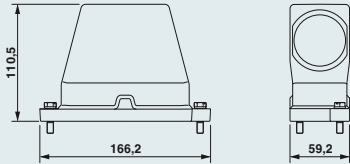
Technical data	
Housing material	Aluminum die-cast
Surface material	Powder-coated, black
Lock material	Stainless steel
Sealing material	NBR
Ambient temperature (operation)	-40 °C ... 125 °C
IP degree of protection (when plugged in)	IP68 (0.5 bar, 24 h) / IP69K

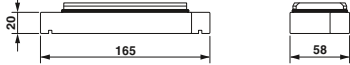
Ordering data

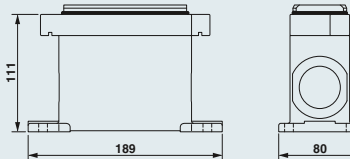
Description	Thread	Type	Order No.	Pcs. / Pkt.	Dimensions
Sleeve housing Height: 110.5 mm 	1x M32 1x M40	Cable outlet: top HC-HPR-B16-HHWH-1TTM32-EM-BK HC-HPR-B16-HHWH-1TTM40-EM-BK	1411059	1	
			1411885	1	
Sleeve housing Height: 110.5 mm 	1x M32 1x M40	Cable outlet: lateral HC-HPR-B16-HHWH-1STM32-EM-BK HC-HPR-B16-HHWH-1STM40-EM-BK	1411058	1	
			1411884	1	
Panel mounting base Height: 20 mm 		Without cover HC-HPR-B16-BFH-EMR-BK	1411060	1	
Box mounting base Height: 111 mm 	2x M32 2x M40	Without cover HC-HPR-B16-SHFH-2SSM32-EMR-BK HC-HPR-B16-SHFH-2SSM40-EMR-BK	1411054 1411886	1 1	

Accessories









Cable glands
From page 680

**Size B24, metal,
housing for railway applications,
screw locking**

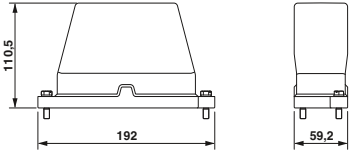

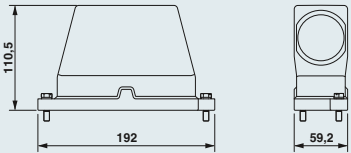
General data	
Housing material	Aluminum die-cast
Surface material	Powder-coated, black
Lock material	Stainless steel
Sealing material	NBR
Ambient temperature (operation)	-40 °C ... 125 °C
IP degree of protection (when plugged in)	IP68 (0.5 bar, 24 h) / IP69K

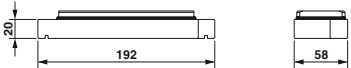
Technical data	
Housing material	Aluminum die-cast
Surface material	Powder-coated, black
Lock material	Stainless steel
Sealing material	NBR
Ambient temperature (operation)	-40 °C ... 125 °C
IP degree of protection (when plugged in)	IP68 (0.5 bar, 24 h) / IP69K

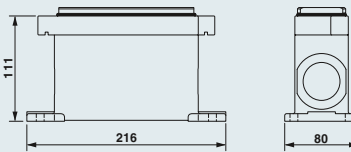
Description		Thread	Type	Order No.	Pcs. / Pkt.	Dimensions
Sleeve housing Height: 110.5 mm 	1x M32 1x M40	Cable outlet: top HC-HPR-B24-HHWH-1TTM32-EM-BK HC-HPR-B24-HHWH-1TTM40-EM-BK	1411888	1		
			1411062	1		
Sleeve housing Height: 110.5 mm 	1x M32 1x M40	Cable outlet: lateral HC-HPR-B24-HHWH-1STM32-EM-BK HC-HPR-B24-HHWH-1STM40-EM-BK	1411887	1		
			1411061	1		
Panel mounting base Height: 20 mm 		Without cover HC-HPR-B24-BFH-EMR-BK	1411055	1		
Box mounting base Height: 111 mm 	2x M32 2x M40	Without cover HC-HPR-B24-SHFH-2SSM32-EMR-BK HC-HPR-B24-SHFH-2SSM40-EMR-BK	1411889	1		
			1411063	1		

Accessories



Cable glands
From page 680

Heavy-duty connectors

HEAVYCON Compact - contact inserts

Compact series

200 - 690 V, 10 - 40 A

Connection technology:

– Crimp connection

To determine the corresponding housing, see cross-reference list on page 482.

Notes:
Order crimp contacts separately
Only operate connectors when there is no load/the power is switched off
For assembly instructions, see phoenixcontact.net/products
For connection technologies, see page 4



Type	Technical data				
	① HC-COM- 8- E...C	② HC-COM- 17- E...C	③ HC-COM- 4/2- E...C		
			Power contacts	Control contacts	
Approvals					
IEC data					
Rated current, contacts (at 40°C)	A	16	10	40	10
Surge voltage category		III	III		III
Pollution degree		3	3		3
Rated voltage (III/3) contacts	V	500	200	400 / 690	250
Rated surge voltage, contacts	kV	6	4	6	4
Connection cross section	mm ²	0.5 ... 4	0.14 ... 2.5	1.5 ... 6	0.14 ... 2.5
UL data					
Rated voltage	V	600	600	600	-
Rated current	A	-	19.5	40	-
Connection cross section	AWG	20-12	22-14	16-10	-
CSA / cUL data					
Rated voltage	V	600	600	600	-
Rated current	A	-	10.5	30	-
Connection cross section	AWG	20-12	22-14	16-10	-
Material data					
Contact carrier material		PC	PC	PC	
Inflammability class in acc. with UL 94		V0	V0	V0	
Contact material		Copper alloy	Copper alloy	Copper alloy	
Contact surface material		Ag (alternatively Au)	Ag (alternatively Au)	Ag	Ag (alternatively Au)
Temperature data					
Ambient temperature range	°C	-40 ... 100	-40 ... 100	-40 ... 100	
General data					
Connection method		Crimp connection	Crimp connection	Crimp connection	Crimp connection
Stripping length	mm	7.5	8	9	8
				9.6	6
No. of pos.		8	17	4	2
Contact numbering		1 - 8	1 - 17	1 - 4	1 - 2
Insertion/withdrawal cycles		≥ 500	≥ 500	≥ 500	

Derating curves

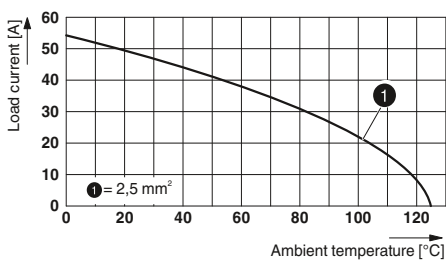



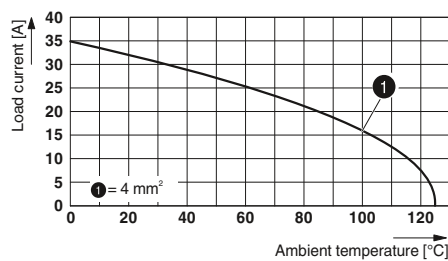

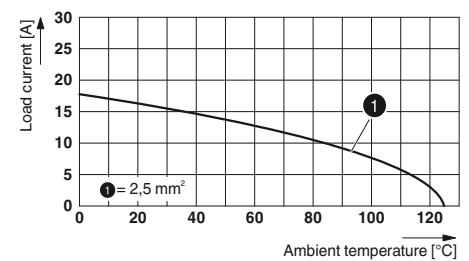

HC-COM- 4/2-E...C

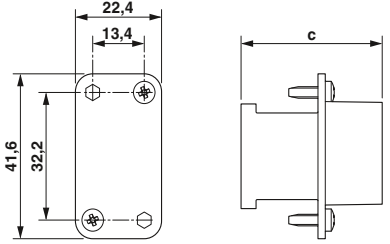
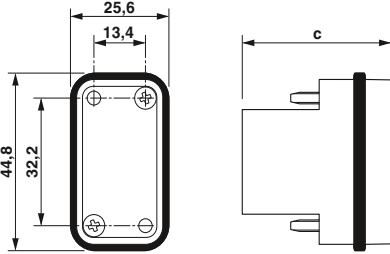

HC-COM- 8-E...C



HC-COM- 17-E...C

Description	Pos.	Number	Size	Ordering data			Pcs. / Pkt.	Dimensions (in mm)																																			
				Type	Socket	Plug																																					
Crimp connection CK 2,5 	8	1 - 8	COM	① HC-COM- 8-E...C	1408494	1408481	2	 <p>Dimensional drawing: socket</p>  <p>Dimensional drawing: plug</p>																																			
Crimp connection CK 1,6 	17	1 - 17	COM	② HC-COM- 17-E...C	1408478	1408465	2																																				
Crimp connection CK 4,0/CK 1,6 	4 / 2	1 - 4	COM	③ HC-COM- 4/2-E...C	1408517	1408504	2																																				
Turned crimp contacts CK 1,6 Silver-plated 			Cross section mm ² / AWG 0.14 - 0.37 / 26 - 22 0.5 / 20 0.75 / 18 0.75 - 1 / 18 1.5 / 16 2.5 / 14	CK1,6-ED-0,37... AG CK1,6-ED-0,50... AG CK1,6-ED-0,75... AG CK1,6-ED-1,00... AG CK1,6-ED-1,50... AG CK1,6-ED-2,50... AG	1663394 1663404 1663417 1663420 1663433 1663446	1663336 1663349 1663352 1663365 1663378 1663381	100 100 100 100 100 100	<table border="1"> <thead> <tr> <th></th> <th>a</th> <th>b</th> <th>c</th> <th>d</th> </tr> </thead> <tbody> <tr> <td>① Socket</td> <td></td> <td></td> <td></td> <td></td> </tr> <tr> <td>① Plug</td> <td></td> <td></td> <td>38.5</td> <td></td> </tr> <tr> <td>② Socket</td> <td></td> <td></td> <td>36.7</td> <td></td> </tr> <tr> <td>② Plug</td> <td></td> <td></td> <td>38.7</td> <td></td> </tr> <tr> <td>③ Socket</td> <td></td> <td></td> <td>48.05</td> <td></td> </tr> <tr> <td>③ Plug</td> <td></td> <td></td> <td></td> <td></td> </tr> </tbody> </table>		a	b	c	d	① Socket					① Plug			38.5		② Socket			36.7		② Plug			38.7		③ Socket			48.05		③ Plug				
	a	b	c	d																																							
① Socket																																											
① Plug			38.5																																								
② Socket			36.7																																								
② Plug			38.7																																								
③ Socket			48.05																																								
③ Plug																																											
Turned crimp contacts CK 2,5 Silver-plated 			Cross section mm ² / AWG 0.5 / 20 0.75 / 18 0.75 - 1 / 18 1.5 / 16 2.5 / 14 4 / 12	CK2,5-ED-0,50... AG CK2,5-ED-0,75... AG CK2,5-ED-1,00... AG CK2,5-ED-1,50... AG CK2,5-ED-2,50... AG CK2,5-ED-4,00... AG	1663640 1663653 1663666 1663679 1663682 1663705	1663572 1663585 1663598 1663608 1663611 1663637	100 100 100 100 100 100																																				
Turned crimp contacts CK 4,0 Silver-plated 			Cross section mm ² / AWG 1.5 / 16 2.5 / 14 4 / 12 6 / 10	CK4,0-ED-1,50... AG CK4,0-ED-2,50... AG CK4,0-ED-4,00... AG CK4,0-ED-6,00... AG	1663271 1663284 1663297 1663307	1663239 1663242 1663255 1663268	25 25 25 25																																				

Accessories



Dummy sockets
From page 639



Crimping tools
From page 636



Crimp contacts, gold-plated
phoenixcontact.net/products

Heavy-duty connectors

HEAVYCON Compact - housing





Compact series, plastic, sleeve housing

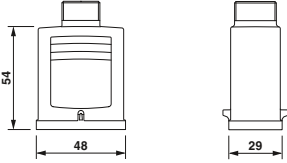

Technical data

General data	
Housing material	Polycarbonate
Lock material	-
Sealing material	-
Ambient temperature (operation)	-40 °C ... 125 °C
IP degree of protection (when plugged in)	IP65 / IP66

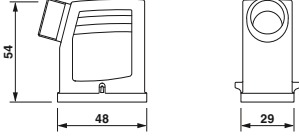







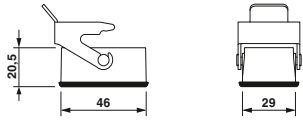

Ordering data

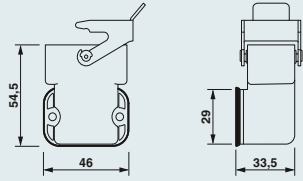
Description	Thread	Type	Order No.	Pcs. / Pkt.	Dimensions
Sleeve housing Height: 54 mm 	1x Pg16	Cable outlet: top HC-COM-K-TFL-O1PG16-G	1408342	2	
Sleeve housing Height: 54 mm 	1x Pg16	Cable outlet: lateral HC-COM-K-TFL-O1PG16-S	1408339	2	
Pg16 cable gland 		VC-K-KV-PG16(9-13) VC-K-KV-PG16(11,5-15,5)	1853764 1854844	5 5	

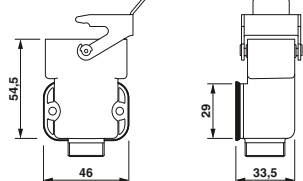
Compact series, plastic, supporting base element

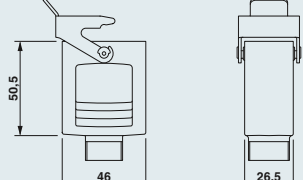
General data		Technical data
Housing material		Polycarbonate
Lock material		Stainless steel
Sealing material		NBR
Ambient temperature (operation)		-40 °C ... 125 °C
IP degree of protection (when plugged in)		IP65 / IP66



Description		Thread	Type	Order No.	Pcs. / Pkt.	Dimensions
Panel mounting base Height: 20.5 mm 			Straight version HC-COM-K-AML-GR	1408355	2	
Panel mounting base Height: 33.5 mm 			Angled version HC-COM-K-AML-GW	1408368	2	
Box mounting base Height: 33.5 mm 		1x Pg16	HC-COM-K-SML-O1PG16	1408371	2	
Coupling housing Height: 50.5 mm 		1x Pg16	HC-COM-K-KML-O1PG16	1408384	2	
Pg16 cable gland 			HC-COM-K-KV-PG16(9-12) SML HC-COM-K-KV-PG16(11,5-15) SML	1409286 1409299	2 2	
Protective cover, plastic 			Socket HC-COM-K-SD-FLU-BU/FS Plug HC-COM-K-SD-FLU-ST/FS	1408397 1408407	2 2	

Notes:
Box mounting base with open bottom

Heavy-duty connectors

HEAVYCON accessories, contact inserts

Type J iron and constantan crimp contacts

In hot runner injection molding machines, temperatures are often measured using iron/constantan thermocouples. Iron/constantan elements are used for temperatures up to around 450°C.

When measuring the temperatures using iron/constantan elements, the control system is connected with iron/constantan conductors. The connection point of the iron or constantan conductor to a brass crimp contact of a connector would result in thermoelectric voltages that can falsify the measuring result. We therefore recommend using iron/constantan crimp contacts.

Iron/constantan crimp contacts can be used in contact inserts of the A / B / BB / HV series and in the HC-M-HV..., HC-M-06..., HC-M-08..., HC-M-20-... modules.

A combination (standard contacts/thermo contacts) of crimp contact inserts is also possible.

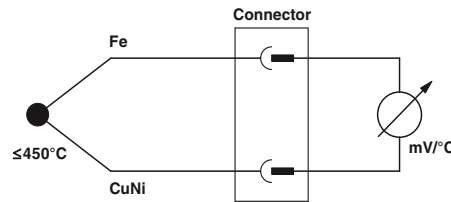

Material data
Contact material
Contact surface material
Stripping length of the individual wire
Insertion/withdrawal cycles
Temperature data
Ambient temperature (operation)

Description
Turned socket contacts, 0.5 mm² iron (Fe), Au surface Constants (CuNi), uncoated
Turned pin contacts, 0.5 mm² iron (Fe), Au surface Constants (CuNi), uncoated



Turned crimp contacts, for contact inserts:
HC-M-06, HC-M-HV, HC-M-08, HC-M-20, HC-B, HC-BB, HC-A, HC-HV

Technical data	
CK2,5-ED...FE	CK2,5-ED...CUNI
Iron	Copper-nickel (constants)
Hard gold-plated	-
7.5 mm (9.5 mm at HC-M-HV...)	7.5 mm (9.5 mm at HC-M-HV...)
≥ 500	≥ 500
-40 °C ... 125 °C	-40 °C ... 125 °C

Ordering data		
Type	Order No.	Pcs. / Pkt.
CK2,5-ED-0,5BU FE	1585773	25
CK2,5-ED-0,5BU CUNI	1585757	25
CK2,5-ED-0,5ST FE	1585760	25
CK2,5-ED-0,5ST CUNI	1585744	25

FO crimp contacts

Fiber optics crimp contacts (980/1000 μm) are suitable for coupling fiber optic cables (polymer fiber optic cable). These can be used in the crimp contact carriers:

- VC-D (for turned contacts)
- HC M 12... / HC-M-17... / HC-M-03/04...
- HC-D... (for turned contacts) and
- HC-DD...

The optic fibers are polished, stripped, and then crimped.

Notes:
For crimping pliers, assembly and removal tools, see 637

Material data
Contact material
Insertion/withdrawal cycles

Description
Fiber optic contact POF, turned, for VC-D contact carriers
Socket
Plug
Polisher, metal, for CK1,6-...POF contacts, POF conductor diameter: 2.2 mm
Stripping tool for FO cables - stripping pliers for individual elements
Polishing foil
Polishing paper



Crimp contacts for fiber optic cables, polymer optic fibers (POF)

Technical data	
Nickel silver	≥ 500

Ordering data		
Type	Order No.	Pcs. / Pkt.
CK1,6-ED-BU-POF	1885004	50
CK1,6-ED-ST-POF	1884995	50
POLISHER-POF	1686122	1
PSM-FO-STRIP	2744199	1
POLFOL 1 MIC-POF	1636800	10
POLPAP 1500-POF	1636813	10

Heavy-duty connectors

HEAVYCON accessories, contact inserts

CRIMPFOX crimping pliers for turned contacts

- The integrated positioning tool ensures that the contacts are perfectly aligned in the die
- Marked die stations for precise processing of the relevant cross sections

Notes:
For replacement dies and retaining springs, go to the product area on the website at phoenixcontact.net/products.



Conductor cross section of 0.5 - 4 mm²

Conductor cross section of 6 - 10 mm²

Application range	
Conductor	mm ² / AWG
Compression	

Description	
<p>Crimping pliers, for turned contacts with a pin diameter of 1.6 / 2.5 / 4.0 mm</p> <ul style="list-style-type: none"> - For CK1,6-ED ... , CK2,5-ED... CK4,0-E D... 0.5-4 mm² turned contacts - For CK4,0-ED...6 - 10 mm² turned contacts 	

<p>Removal tool</p> <ul style="list-style-type: none"> - For CK1,6-ED.../CK1,6-ER.../CK1,6...POF contacts - For CK2,5-ED... contacts - For CK4,0-ED... contacts

Technical data		
0.5 ... 4 / 22 ... 12		
Square crimp		

Ordering data		
Type	Order No.	Pcs. / Pkt.
CRIMPFOX-TC 4	1212113	1

Accessories		
VC-EW 1,6	1884869	1
CK2,5-EWZ	1662722	1
CK4,0-EWZ	1662735	1

Technical data		
6 ... 10 / 10 ... 8		
Square crimp		

Ordering data		
Type	Order No.	Pcs. / Pkt.
CRIMPFOX-TC 10	1212114	1

Accessories		
CK4,0-EWZ	1662735	1

CRIMPFOX universal pliers for accommodating various crimp inserts

- One of the key features of the CRIMPFOX-M crimping pliers is the way the crimp inserts can be quickly replaced without the need for tools

Notes:
For more crimping dies for ferrules, cable lugs, slip-on sleeves, turned contacts, coaxial, RJ45, and RJ11 connectors, visit phoenixcontact.net/products



Basic pliers

Application range	
Compression	

Description	
<p>Basic pliers, for accommodating dies for various contact types, pressure lock can be unlocked, lateral entry</p>	

<p>Die,</p> <p>For turned contacts with pin diameters 2.5 mm and 4.0 mm (CK 2,5...CK 4,0), cross section 0.14 - 4 mm²</p> <p>For turned contacts with pin diameter 4 mm (CK 4,0...), cross section 6 - 10 mm²</p>
--

Technical data		
Universal		

Ordering data		
Type	Order No.	Pcs. / Pkt.
CRIMPFOX-M	1212072	1

Accessories		
CRIMPFOX-M TC 4/DIE	1212075	1
CRIMPFOX-M TC 10/DIE	1212076	1

CRIMPFOX crimping pliers for rolled contacts

- For processing rolled contacts for fiber optics (POF)



Conductor cross section of 0.5 - 1.5 mm²

Technical data	
Application range	mm ² / AWG
Conductor	0.5 ... 1.5 / -
Compression	Universal
Ordering data	
Description	Type
Crimping pliers - For rolled CK1,6-ER... contacts	CRIMPFOX-1,6-ER-1,50-AT
	Order No. 1884843
	Pcs. / Pkt. 1
Accessories	
Assembly tool - For CK1,6-ED.../CK2,5-ED.../CK1,6-ER... contacts	CK1,6/2,5-MWZ
	Order No. 1676734
	Pcs. / Pkt. 1
Removal tool - For CK1,6-ED.../CK1,6-ER.../CK1,6...POF contacts	VC-EW 1,6
	Order No. 1884869
	Pcs. / Pkt. 1

CRIMPFOX crimping pliers for coaxial connectors

- CRIMPFOX-CX... are crimping pliers for processing coaxial connectors
- Unlockable pressure lock
- Lateral conductor entry



For coaxial connectors



Conductor cross section of 0.14 - 2.5 mm²

Notes:
For replacement dies and retaining springs, go to the product area on the website at phoenixcontact.net/products.

Technical data	
Application range	HEX crimp
Compression	HEX crimp
Ordering data	
Description	Type
Crimp pliers, for: - for coaxial connectors, 1.69 mm, 3.25 mm, 4.52 mm, three marked die stations, unlockable pressure lock, lateral entry, hex crimp - For turned VS...CD contacts (D-SUB contacts) ; crimping tool with four mandrels	CRIMPFOX-CX 4,52
	Order No. 1212094
	Pcs. / Pkt. 1
Accessories	
Removal tool - For coax HC-M-04...KOAX... contacts - For D-SUB VS...CD... contacts	HC-M4-KOAX-EWZ
	Order No. 1676747
	Pcs. / Pkt. 1

Technical data	
Application range	Indent crimp
Compression	Indent crimp
Ordering data	
Description	Type
	CRIMPFOX RC 2,5
	Order No. 1205448
	Pcs. / Pkt. 1
Accessories	
	EWR
	Order No. 1665075
	Pcs. / Pkt. 1

Heavy-duty connectors

HEAVYCON accessories, contact inserts

Coding profiles

– Can be coded in seconds, thanks to the coding profiles



HC/HC-S coding profile

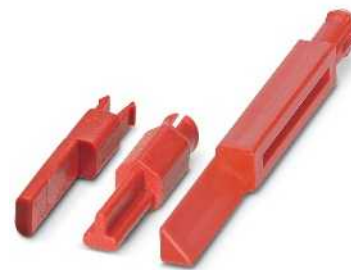

HS2/D7/Q12 coding profile

		Technical data			Technical data		
Material data							
Material		PA			PA		
		Ordering data			Ordering data		
Description		Type	Order No.	Pcs. / Pkt.	Type	Order No.	Pcs. / Pkt.
Coding profiles, for contact inserts in series:							
HC-B... and HC-B...A-UT... terminal adapter		CP-HC	1686478	10			
HC-B...A-DT...							
HC-A10..., HC-BB...		CP-HC-S	1410916	10			
Coding profiles, for contact inserts in series:							
HC-HS2-D7-E...S					HC-HS 2-CP	1586280	50
HC-D 7-EBUC-COD					HC-D 7-CD-BU	1408601	50
HC-D 7-ESTC-COD					HC-D 7-CD-ST	1408591	50
HC-Q12...					HC-Q 12-COD	1409435	10

Coding bolts

– Up to 6 plug-in connections can be protected against mismatching

Notes:
For assembly instructions, see phoenixcontact.net/products



Coded bolts

		Technical data		
Material data				
Material		Steel		
		Ordering data		
Description		Type	Order No.	Pcs. / Pkt.
Coding bolt, for contact inserts in series:				
HC-B...		HC-CB	1772722	10

Coding pins, sockets

- Up to 16 plug-in connections can be protected against mismatching
- Mandatory for HC-D..., HC-DD... as well as HC-M-25-MOD..., HC-M-04MOD..., and HC-M-DSUB09...

Notes:
For assembly instructions, see phoenixcontact.net/products



Coding pin/socket



Coding pin/socket

Material data
Material

Technical data

Steel, galvanized

Ordering data

Type	Order No.	Pcs. / Pkt.
HC-CST	1676857	10
HC-CBU	1676860	10

Technical data

Steel, galvanized

Ordering data

Type	Order No.	Pcs. / Pkt.
HC-CST-MOD	1636127	10
HC-CBU-MOD	1636130	10

Description

Coding sockets and pins, for coding to protect against mismatching and as a guide to prevent accidentally jamming the connector in at an angle, cannot be used with HC-Modular and HC-D7 ...
Coding pin
Coding socket
Coding sockets and pins, for coding to protect against mismatching and as a guide to prevent accidentally jamming the connector in at an angle, for HC-Modular
Coding pin
Coding socket

Dummy sockets

Dummy sockets prevent plugging of a plug-in connection if a pin is mounted at the coding position in the pin insert. Identical connectors can thus be protected against being plugged in incorrectly.

Notes:
For assembly instructions, see phoenixcontact.net/products



Dummy socket



Dummy socket

Material data
Material

Technical data

PA

Ordering data

Type	Order No.	Pcs. / Pkt.
CK2,5-ED-BB	1584693	100

Technical data

Copper alloy

Ordering data

Type	Order No.	Pcs. / Pkt.
CK1,6-ED-BB	1645888	50

Description

Dummy sockets, for contact inserts with turned socket contacts of type:
CK-2,5-ED...
CK-1,6-ED...

Heavy-duty connectors

HEAVYCON accessories, contact inserts

PE screws, PE multiplier

If several PE conductors are led via one contact insert, additional PE connections are required. This is done using additional PE screws or the PE multiplier.



PE screw



PE multiplier

			Technical data			Technical data		
Material data								
Material			Steel, galvanized			Brass, nickel-plated		
Application range								
Connection cross section			mm ²			0,5 ... 2,5		
Connection cross section			AWG			20 ... 14		
			Ordering data			Ordering data		
Description			Type	Order No.	Pcs. / Pkt.	Type	Order No.	Pcs. / Pkt.
PE screw, for contact inserts in series:								
HC-B..., HC-BB..., HC-DD..., HC-D40..., HC-D64...			HC-B-PES	1604997	10			
HC-HS 6...			HC-HS-PES	1586219	100			
PE screw, for contact inserts in series:								
HC-A..., HC-D15..., HC-D25...			HC-A-PES	1584868	10			
PE multiplier, with 3 PE connections, for contact inserts in series:								
HC-B..., HC-BB..., HC-DD..., HC-D40..., HC-D64...						HC-B-3PE	1644326	1

PE terminal block base

If two PE conductors are led via one contact insert, additional PE connections are required. For HC-K6/0... this is done using a PE terminal block base.



PE terminal block base

		Technical data		
Material data				
Material		Brass		
		Ordering data		
Description		Type	Order No.	Pcs. / Pkt.
PE terminal block base, PE extension for HC-K6/0... contact inserts				
Socket		HC-K 6 PE 16 QMM F	1583869	25
Plug		HC-K 6 PE 16 QMM M	1583870	25

Strain relief clamps

Cable trees with crimp contacts must not put a strain on the engaged contacts with their weight.

This is avoided by the use of strain relief clamps.



Lateral cable outlet



Straight cable outlet

Material data
Material
Description
Strain relief clamps , clamping area of 9 - 19 mm, for contact inserts in series: HC-B..., HC-BB..., HC-D40..., HC-D64..., HC-DD..., HC-HV...

Technical data		
Steel, galvanized		
Ordering data		
Type	Order No.	Pcs. / Pkt.
HC-B-ZS	1685330	10

Technical data		
Steel, galvanized		
Ordering data		
Type	Order No.	Pcs. / Pkt.
HC-B-ZG	1685327	10

Docking frame

Docking frames ensure that socket and pin inserts are located in insert systems and contact is made reliably.

Notes:
Due to the floating frame, the mounting panel must be grounded.



Docking frames

Material data	
Material	
Insertion/withdrawal cycles	
Temperature data	
Ambient temperature (operation)	°C
Description	
Docking frame , with 4 flat headed screws with shoulder, for contact inserts in series: B6, DD24, BB10, K, M B10, DD42, BB18, K, M B16, D40, DD72, BB32, K, M B24, D64, DD108, BB46, K, M	

Technical data		
Stainless steel		
≥ 500		
Ordering data		
Type	Order No.	Pcs. / Pkt.
HC-B 6-ANDOCK	1586112	1
HC-B 10-ANDOCK	1586125	1
HC-B 16-ANDOCK	1586138	1
HC-B 24-ANDOCK	1586141	1

Heavy-duty connectors

HEAVYCON accessories - housing

Plastic cable glands for EVO B series housing



Plastic cable gland

General data		Technical data		
Material		PA		
Ambient temperature (operation)	°C	-40 ... 100		
Description		Ordering data		
Description	Thread type	Type	Order No.	Pcs. / Pkt.
Cable gland , for HEAVYCON EVO B series plastic housing, for cable diameter:				
7 mm ... 13 mm	M20	HC-B-G-M20-PLRBK	1407669	1
9 mm ... 17 mm	M25	HC-B-G-M25-PLRBK	1407670	1
11 mm ... 21 mm	M32	HC-B-G-M32-PLRBK	1407671	1
19 mm ... 28 mm	M40	HC-B-G-M40-PLRBK	1407672	1

Metal cable glands for EVO B series housing



Metal cable gland for EMC applications



Metal cable gland for higher strain relief

General data		Technical data			Technical data		
Material		Die-cast aluminum, corrosion-resistant			Die-cast aluminum, corrosion-resistant		
Ambient temperature (operation)	°C	-40 ... 125			-40 ... 125		
Description		Ordering data			Ordering data		
Description	Thread type	Type	Order No.	Pcs. / Pkt.	Type	Order No.	Pcs. / Pkt.
Cable gland , for HEAVYCON EVO B series metal housing, for EMC applications, for cable diameter:							
7 mm ... 13 mm	M20	HC-B-G-M20-EC-AL	1411439	1			
11 mm ... 16 mm	M25	HC-B-G-M25-EC-AL	1411446	1			
14 mm ... 21 mm	M32	HC-B-G-M32-EC-AL	1411440	1			
19 mm ... 27 mm	M40	HC-B-G-M40-EC-AL	1411441	1			
Cable gland , for HEAVYCON EVO metal housing, for higher strain relief, with NBR seal, for cable diameter:							
7 mm ... 13 mm	M20				HC-B-G-M20-ER-AL	1411442	1
11 mm ... 16 mm	M25				HC-B-G-M25-ER-AL	1411443	1
14 mm ... 21 mm	M32				HC-B-G-M32-ER-AL	1411444	1
19 mm ... 27 mm	M40				HC-B-G-M40-ER-AL	1411445	1

Plastic cable glands and thread adapters for EVO D series housing



Plastic cable gland



Plastic thread adapter

		Technical data			Technical data		
General data							
Material		PA			PA		
Ambient temperature (operation) °C		-40 ... 100			-40 ... 125		
		Ordering data			Ordering data		
Description	Thread type	Type	Order No.	Pcs. / Pkt.	Type	Order No.	Pcs. / Pkt.
Cable gland , for HEAVYCON EVO D series plastic housing, for cable diameter:							
7 mm ... 13 mm	M20	HC-D-G-M20-PLRBK	1411350	1			
9 mm ... 17 mm	M25	HC-D-G-M25-PLRBK	1411351	1			
Thread adapter , for HEAVYCON EVO D series plastic housing							
	M25				HC-D-TA-M25-PLRBK	1411352	1
	Pg16				HC-D-TA-PG16-PLR-BK	1411353	1
	3/4 inch NPT				HC-D-TA-NPT-3/4-PLR-BK	1411354	1

Thread adapters for EVO B series housing

new

new



Plastic thread adapter



Metal thread adapter

		Technical data			Technical data		
General data							
Material		Polyamide			Die-cast aluminum, corrosion-resistant		
Ambient temperature (operation) °C		-40 ... 100			-40 ... 125		
		Ordering data			Ordering data		
Description	Thread type	Type	Order No.	Pcs. / Pkt.	Type	Order No.	Pcs. / Pkt.
Thread adapter , for HEAVYCON EVO B series housing							
	M20	HC-B-TA-M20-PLR-BK	1414243	1	HC-B-TA-M20-ER-AL	1414256	1
	M25	HC-B-TA-M25-PLR-BK	1414244	1	HC-B-TA-M25-ER-AL	1414257	1
	M32	HC-B-TA-M32-PLR-BK	1414245	1	HC-B-TA-M32-ER-AL	1414258	1
	M40	HC-B-TA-M40-PLR-BK	1414246	1	HC-B-TA-M40-ER-AL	1414259	1
	Pg13.5	HC-B-TA-PG13-PLR-BK	1414247	1	HC-B-TA-PG13-ER-AL	1414260	1
	Pg16	HC-B-TA-PG16-PLR-BK	1414248	1	HC-B-TA-PG16-ER-AL	1414261	1
	Pg21	HC-B-TA-PG21-PLR-BK	1414249	1	HC-B-TA-PG21-ER-AL	1414262	1
	Pg29	HC-B-TA-PG29-PLR-BK	1414250	1	HC-B-TA-PG29-ER-AL	1414263	1
	1/2-inch NPT	HC-B-TA-NPT-1/2-PLR-BK	1414251	1	HC-B-TA-NPT-1/2-ER-AL	1414264	1
	3/4 inch NPT	HC-B-TA-NPT-3/4-PLR-BK	1414252	1	HC-B-TA-NPT-3/4-ER-AL	1414265	1
	1/1 inch NPT	HC-B-TA-NPT-1/1-PLR-BK	1414253	1	HC-B-TA-NPT-1/1-ER-AL	1414266	1
	1 1/4 in. NPT	HC-B-TA-NPT-1 1/4-PLR-BK	1414254	1	HC-B-TA-NPT-1 1/4-ER-AL	1414267	1

Heavy-duty connectors

HEAVYCON accessories - housing

Corrugated pipe adapter for EVO B series housing

new

Notes:
For protective hoses for corrugated pipe adapters, see Catalog 5



Plastic corrugated pipe adapter

General data		Technical data		
Material		PA		
Ambient temperature (operation)	°C	-40 ... 115		
Description		Ordering data		
	Thread type	Type	Order No.	Pcs. / Pkt.
Corrugated pipe adapter , for HEAVYCON EVO B series plastic housing, for protective hose outside diameter:				
21.2 mm	M20	HC-B-GCA-M20-PLRBK	1412021	1
28.5 mm	M25	HC-B-GCA-M25-PLRBK	1411973	1
34.5 mm	M32	HC-B-GCA-M32-PLRBK	1412022	1
42.5 mm	M40	HC-B-GCA-M40-PLRBK	1412023	1

Screw connection for multiple cables for EVO B series housing

new

new



Plastic cable gland for multiple cables



Metal cable gland for multiple cables

General data		Technical data			Technical data		
Material		PA			Die-cast aluminum, corrosion-resistant		
Ambient temperature (operation)	°C	-30 ... 100			-30 ... 100		
Description		Ordering data			Ordering data		
	Thread type	Type	Order No.	Pcs. / Pkt.	Type	Order No.	Pcs. / Pkt.
Cable gland , for HEAVYCON EVO B series housing, with seal insert for cable diameter:							
Without bore hole	M40	HC-B-GM0-M40-PLTBK	1414643	1	HC-B-GM0-M40-ET-AL	1414647	1
4x 10 mm	M40	HC-B-GM4X10-M40-PLTBK	1414644	1	HC-B-GM4X10-M40-ET-AL	1414648	1
5x 8.5 mm	M40	HC-B-GM5X8,5-M40-PLTBK	1414645	1	HC-B-GM5X8,5-M40-ET-AL	1414649	1
8x 6.5 mm	M40	HC-B-GM8X6,5-M40-PLTBK	1414646	1	HC-B-GM8X6,5-M40-ET-AL	1414650	1

**Screw connection
with bend protection
for EVO B series housing**

new

new



**Plastic cable gland
with bend protection**

**Metal cable gland
with bend protection**

Technical data

Technical data

General data	
Material	Polyamide
Ambient temperature (operation)	°C -40 ... 100

General data	
Material	-
Ambient temperature (operation)	°C -40 ... 100

Ordering data

Ordering data

Description	Thread type
Cable gland , for HEAVYCON EVO B series housing, for cable diameter:	
6 mm ... 13 mm	M20
9 mm ... 17 mm	M25
13 mm ... 21 mm	M32
16 mm ... 28 mm	M40

Type	Order No.	Pcs. / Pkt.
HC-B-GB-M20-PLRBK	1414660	1
HC-B-GB-M25-PLRBK	1414661	1
HC-B-GB-M32-PLRBK	1414662	1

Type	Order No.	Pcs. / Pkt.
HC-B-GB-M20-ER-AL	1414663	1
HC-B-GB-M25-ER-AL	1414664	1
HC-B-GB-M32-ER-AL	1414665	1
HC-B-GB-M40-ER-AL	1414666	1

**Screw connection
with bend protection and strain relief
for EVO B series housing**

new

new



**Plastic cable gland
with strain relief**

**Metal cable gland
with strain relief**

Technical data

Technical data

General data	
Material	Polyamide
Ambient temperature (operation)	°C -40 ... 100

General data	
Material	-
Ambient temperature (operation)	°C -40 ... 100

Ordering data

Ordering data

Description	Thread type
Cable gland , for HEAVYCON EVO B series housing, for cable diameter:	
6 mm ... 13 mm	M20
9 mm ... 17 mm	M25
13 mm ... 21 mm	M32
16 mm ... 28 mm	M40

Type	Order No.	Pcs. / Pkt.
HC-B-GTRS-M20-PLRBK	1414651	1
HC-B-GTRS-M25-PLRBK	1414652	1
HC-B-GTRS-M32-PLRBK	1414654	1

Type	Order No.	Pcs. / Pkt.
HC-B-GTRS-M20-ER-AL	1414656	1
HC-B-GTRS-M25-ER-AL	1414657	1
HC-B-GTRS-M32-ER-AL	1414658	1
HC-B-GTRS-M40-ER-AL	1414659	1

Heavy-duty connectors

HEAVYCON accessories - housing

Protective cover for sleeve housing



Protective cover with single locking latch

Technical data

	Technical data		
	Plastic, gray	Plastic, black	Metal
General data			
Degree of protection	IP54	IP54	IP65
Material	PA	PA	Aluminum, die-cast
Inflammability class according to UL 94	HB	HB	-
Ambient temperature (operation) °C	-20 ... 100	-20 ... 100	-40 ... 125

Ordering data

Description	Ordering data					
	Order No.	Pcs. / Pkt.	Order No.	Pcs. / Pkt.	Order No.	Pcs. / Pkt.
Protective cover, for sleeve housing without locking latch, with retaining cord, with seal, for housing sizes:						
B6	1678282	10	1414634	1	1644546	10
B10	1678295	10	1414635	1	1584512	10
B16	1678318	10	1414636	1	1584525	10
B24	1678334	10	1414637	1	1584538	10



Protective cover with double locking latch

Technical data

	Technical data		
	Plastic, gray	Plastic, black	Metal
General data			
Degree of protection	IP54	IP54	IP65
Material	PA	PA	Aluminum, die-cast
Inflammability class according to UL 94	HB	HB	-
Ambient temperature (operation) °C	-20 ... 100	-20 ... 100	-40 ... 125

Ordering data

Description	Ordering data					
	Order No.	Pcs. / Pkt.	Order No.	Pcs. / Pkt.	Order No.	Pcs. / Pkt.
Protective cover, for sleeve housing without locking latch, with retaining cord, with seal, for housing sizes:						
B6	1678305	10	1414638	1	1584541	10
B10	1678321	10	1414639	1	1584554	10
B16	1678347	10	1414640	1	1584567	10

Protective cover for sleeve housing



Protective cover without double locking latch

Technical data

	Technical data		
	Plastic, gray	Plastic, black	Metal
General data			
Degree of protection	IP54	IP54	IP65
Material	PA	PA	Aluminum, die-cast
Inflammability class according to UL 94	HB	HB	-
Ambient temperature (operation) °C	-20 ... 100	-20 ... 100	-40 ... 125

Ordering data

Description	Ordering data					
	Order No.	Pcs. / Pkt.	Order No.	Pcs. / Pkt.	Order No.	Pcs. / Pkt.
Protective cover, for sleeve housing with double locking latch, with retaining cord, with seal, for housing sizes:						
B10	1687260	10	1414631	10	1647750	10
B16	1687273	10	1414632	10	1647763	10
B24	1687286	10	1414633	10	1647776	10

**Protective cover
for panel mounting base**



**Protective cover
without single locking latch**



**Protective cover
without double locking latch**

General data	
Degree of protection	
Material	
Inflammability class according to UL 94	
Ambient temperature (operation)	°C

Technical data		
Plastic, gray	Plastic, black	Metal
IP54	IP54	IP65
PA	PA	Aluminum, die-cast
HB	HB	-
-20 ... 100	-20 ... 100	-40 ... 125

Technical data		
Plastic, gray	Plastic, black	Metal
IP54	IP54	IP65
PA	PA	Aluminum, die-cast
HB	HB	-
-20 ... 100	-20 ... 100	-40 ... 125

Description	
Protective cover , for panel mounting base, box mounting base, and coupling housing with locking latch , with retaining cord, without seal , for housing sizes:	
B6	
B10	
B16	
B24	
B32	
D15	
D25	

Ordering data					
Order No.	Pcs. / Pkt.	Order No.	Pcs. / Pkt.	Order No.	Pcs. / Pkt.
1660180	10	1414623	10	1644559	10
1660177	10	1414625	10	1644562	10
1660151	10	1414626	10	1644588	10
1660148	10	1414627	10	1644601	10
		1414641	10		
		1414642	10		

Ordering data					
Order No.	Pcs. / Pkt.	Order No.	Pcs. / Pkt.	Order No.	Pcs. / Pkt.
1772586	10	1414628	10	1644575	10
1772599	10	1414629	10	1644591	10
1772609	10	1414630	10	1644614	10
1646120	10				

**Replacement protective cover
for EVO supporting base elements**



Hinged protective cover

General data	
Degree of protection	
Material	
Inflammability class according to UL 94	
Ambient temperature (operation)	°C

Technical data	
IP65 / IP66	
PA	
V0	
-40 ... 100	

Description	
Replacement protective cover , hinged, for HEAVYCON EVO supporting base element, for housing sizes:	
B6	
B10	
B16	
B24	
D15	
D25	

Ordering data		
Type	Order No.	Pcs. / Pkt.
HC-B06-BC-HI-PLBK	1407692	1
HC-B10-BC-HI-PLBK	1407693	1
HC-B16-BC-HI-PLBK	1407694	1
HC-B24-BC-HI-PLBK	1407695	1
HC-D15-BC-HI-PLBK	1414673	1
HC-D25-BC-HI-PLBK	1414674	1

Heavy-duty connectors

HEAVYCON accessories - housing

Cover plates

For sealing unused openings in control cabinet manufacturing.



Cover plate,
height: 3.5 mm



Cover plate,
height: 7 mm

		Technical data			Technical data		
General data							
Material		PA			PA		
Color		Light gray			Gray		
Degree of protection		IP54			IP54		
Inflammability class according to UL 94		HB			HB		
Ambient temperature (operation)	°C	-20 ... 100			-20 ... 100		
		Ordering data			Ordering data		
Description		Type	Order No.	Pcs. / Pkt.	Type	Order No.	Pcs. / Pkt.
Cover plate , for a panel cutout in size:							
B6 (cutout: 35 mm x 52 mm)		HC-B 6-AP-GY	1660368	10			
B10 (cutout: 35 mm x 65 mm)		HC-B 10-AP-GY	1660371	10			
B16 (cutout: 35 mm x 86 mm)		HC-B 16-AP-GY	1660384	10	HC-B 16-APV-GY	1661121	10
B24 (cutout: 35 mm x 113 mm)		HC-B 24-AP-GY	1660397	10	HC-B 24-APV-GY	1661037	10
D15 (cutout: 24 mm x 58 mm)		HC-D 15-AP-GY	1660342	10			
D25 (cutout: 24 mm x 74 mm)		HC-D 25-AP-GY	1660355	10			

Adapter plates

For changing panel cutouts to different size.



Adapter plate



Adapter plate

		Technical data			Technical data		
General data							
Material		PA			PA		
Color		Light gray			Light gray		
Degree of protection		IP54			IP54		
Inflammability class according to UL 94		HB			HB		
Ambient temperature (operation)	°C	-20 ... 100			-20 ... 100		
		Ordering data			Ordering data		
Description		Type	Order No.	Pcs. / Pkt.	Type	Order No.	Pcs. / Pkt.
Adapter plate , for reduction from a B24 panel cutout to:							
B16 (cutout: 35 mm x 86 mm)		HC-B 24-ADP-B 16-GY	1660449	10			
B10 (cutout: 35 mm x 65 mm)		HC-B 24-ADP-B 10-GY	1660436	10			
B6 (cutout: 35 mm x 52 mm)		HC-B 24-ADP-B 6-GY	1660407	10			
Adapter plate , for reduction from a B24 panel cutout to:							
3 x D7 (cutout: 21.5 mm x 21.5 mm)					HC-B 24-ADP-3D 7-GY	1661448	10
3 x circular connector cutouts (Ø 21 mm)					HC-B 24-ADP-3RST-GY	1662175	10

D-SUB adapter plates, B series

For installing D-SUB connectors in HEAVYCON B series housing.
 – IP65 with HEAVYCON standard housing
 – IP66 with HEAVYCON EVO housing
 – IP69K with HEAVYCON ADVANCE EEE housing

Notes:
Order D-SUB connectors separately
D-SUB assembly in the adapter plate: front mounting



Adapter plate for a D-SUB connector



Adapter plate for two D-SUB connectors

General data	
Material	PA
Color	Gray
Inflammability class according to UL 94	HB
Ambient temperature (operation)	°C -20 ... 100

Technical data

Material	PA
Color	Gray
Inflammability class according to UL 94	HB
Ambient temperature (operation)	°C -20 ... 100

Technical data

Material	PA
Color	Gray
Inflammability class according to UL 94	HB
Ambient temperature (operation)	°C -20 ... 100

Description
D-SUB adapter plate , for mounting HEAVYCON housings with D-SUB connector, for housing size / D-SUB type: B6 / D-SUB 09 B6 / D-SUB 15 B10 / D-SUB 25 B16 / D-SUB 37 B16 / D-SUB 50

Ordering data

Type	Order No.	Pcs. / Pkt.
HC-B 6-ADP/1 DSUB 9	1775457	2
HC-B 6-ADP/1 DSUB 15	1775473	2
HC-B 10-ADP/1 DSUB 25	1775499	2
HC-B 16-ADP/1 DSUB 37	1775512	2
HC-B 16-ADP/1 DSUB 50	1775538	2

Ordering data

Type	Order No.	Pcs. / Pkt.
HC-B 6-ADP/2 DSUB 9	1775460	2
HC-B 6-ADP/2 DSUB 15	1775486	2
HC-B 10-ADP/2 DSUB 25	1775509	2
HC-B 16-ADP/2 DSUB 37	1775525	2
HC-B 16-ADP/2 DSUB 50	1775541	2

D-SUB adapter plates, D series

For installing D-SUB connectors in HEAVYCON D series housing.
 – IP65 with HEAVYCON standard housing
 – IP66 with HEAVYCON EVO housing

Notes:
Order D-SUB connectors separately
D-SUB assembly in the adapter plate: front mounting



Adapter plate for a D-SUB connector

General data	
Material	PA
Color	Gray
Ambient temperature (operation)	°C -20 ... 100

Technical data

Material	PA
Color	Gray
Ambient temperature (operation)	°C -20 ... 100

Description
D-SUB adapter plate , for equipping HC-D15... housings with one D-SUB connector, D-SUB type: D-SUB 09 D-SUB 15 D-SUB 25

Ordering data

Type	Order No.	Pcs. / Pkt.
HC-D 15-ADP/1 DSUB 9	1661312	2
HC-D 15-ADP/1 DSUB 15	1775253	2
HC-D 15-ADP/1 DSUB 25	1775266	2

Heavy-duty connectors

HEAVYCON accessories - housing

Replacement seals for EVO housing

Notes:

Bond the replacement profile gaskets to the housing, adhesive: Loctite® 454.



Replacement flat gasket for EVO panel mounting bases



Replacement profile gasket for EVO supporting base elements

General data	
Material	NBR
Ambient temperature (operation)	-40 ... 125 °C

Technical data		
NBR		
-40 ... 125		

Technical data		
NBR		
-40 ... 125		

Description	
Replacement seal, for HEAVYCON EVO plastic housing in size:	
B6	
B10	
B16	
B24	
D15	
D25	

Ordering data		
Type	Order No.	Pcs. / Pkt.
HC-B06-SG-RBK	1407702	10
HC-B10-SG-RBK	1407703	10
HC-B16-SG-RBK	1407704	10
HC-B24-SG-RBK	1407705	10
HC-D15-SG-RBK	1414669	1
HC-D25-SG-RBK	1414670	1

Ordering data		
Type	Order No.	Pcs. / Pkt.
HC-B06-SP-RBK	1407706	10
HC-B10-SP-RBK	1407707	10
HC-B16-SP-RBK	1407708	10
HC-B24-SP-RBK	1407709	10
HC-D15-SP-RBK	1414671	1
HC-D25-SP-RBK	1414672	1

Replacement seals for STANDARD housing



Notes:

Bond the replacement profile gaskets to the housing, adhesive: Loctite® 454.



Replacement flat gasket for STANDARD panel mounting bases



Replacement profile gasket for STANDARD supporting base elements

General data	
Material	NBR, conductive
Ambient temperature (operation)	-40 ... 125 °C

Technical data		
NBR, conductive		
-40 ... 125		

Technical data		
NBR, conductive		
-40 ... 125		

Description	
Replacement seal, for HEAVYCON STANDARD metal housing in size:	
B6	
B10	
B16	
B24	

Ordering data		
Type	Order No.	Pcs. / Pkt.
HC-B06-SG-CBK	1411483	10
HC-B10-SG-CBK	1411484	10
HC-B16-SG-CBK	1411485	10
HC-B24-SG-CBK	1411486	10

Ordering data		
Type	Order No.	Pcs. / Pkt.
HC-B06-SP-CBK	1411477	10
HC-B10-SP-CBK	1411479	10
HC-B16-SP-CBK	1411480	10
HC-B24-SP-CBK	1411482	10

**Replacement seals
for HC-B/D housing**

Notes:

Bond the replacement profile gaskets to the housing, adhesive: Loctite® 454.



**Replacement flat gasket
for HC-B/D panel mounting bases**



**Replacement profile gasket
for HC-D supporting base elements**

Technical data

General data	
Material	CR
Ambient temperature (operation)	°C -40 ... 125

Ordering data

Description	
Replacement seal , for HEAVYCON HC-B/D metal housing in size:	
B32	
B48	
D7	
D15	
D25	

Type	Order No.	Pcs. / Pkt.
HC-B 32-FL-DI	1687778	10
HC-B 48-FL-DI	1774678	10
HC-D 7-FL-DI	1645503	10
HC-D 15-FL-DI	1679582	10
HC-D 25-FL-DI	1679595	10

Technical data

General data	
Material	NBR
Ambient temperature (operation)	°C -40 ... 125

Ordering data

Type	Order No.	Pcs. / Pkt.
HC-D 15-PR-DI	1661189	10
HC-D 25-PR-DI	1408054	10

**Replacement seals
for ADVANCE housing**



Notes:

Bond the replacement profile gaskets to the housing, adhesive: Loctite® 454.



**Replacement profile gasket
for ADVANCE sleeve housing**

Technical data

General data	
Material	NBR, conductive
Ambient temperature (operation)	°C -40 ... 125

Ordering data

Description	
Replacement profile gasket , conductive, for uneven mounting panels, for HEAVYCON ADVANCE sleeve housing in size:	
B6	
B10	
B16	
B24	

Type	Order No.	Pcs. / Pkt.
HC-B 6-TMS-EEE-PR-DI	1409794	10
HC-B 10-TMS-EEE-PR-DI	1409804	10
HC-B 16-TMS-EEE-PR-DI	1409817	10
HC-B 24-TMS-EEE-PR-DI	1409820	10

Heavy-duty connectors

HEAVYCON accessories - housing

Replacement latch for EVO B and D series plastic housing



Replacement latch
for EVO B series housing



Replacement latch
for EVO D series housing

Material data
Material

Technical data		
PA		

Technical data		
PA		

Description

Replacement single locking latch, plastic, for HEAVYCON EVO plastic housing in sizes:

- B6
- B10
- B16
- B24

Replacement double locking latch, plastic, for HEAVYCON EVO plastic housing in sizes:

- B10 ... B24

Replacement single locking latch, plastic, for HEAVYCON EVO plastic housing in sizes:

- D15
- D25

Ordering data		
Type	Order No.	Pcs. / Pkt.
HC-B06-SL-PLBK	1407697	10
HC-B10-SL-PLBK	1407698	10
HC-B16-SL-PLBK	1407700	10
HC-B24-SL-PLBK	1407701	10
HC-B10-24-DL-PLBK	1407696	10

Ordering data		
Type	Order No.	Pcs. / Pkt.
HC-D15-SL-PLBK	1414667	1
HC-D25-SL-PLBK	1414668	1

Replacement latch for STANDARD and EVO B and D7 series metal housing



Replacement latch
for STANDARD and EVO B series metal housing



Replacement latch
for D7 series housing

Material data
Material

Technical data		
PA		

Technical data		
PA		

Description

Replacement single locking latch, plastic, for HEAVYCON STANDARD and EVO metal housing in sizes:

- B6
- B10
- B16
- B24

Replacement double locking latch, plastic, for HEAVYCON STANDARD and EVO metal housing in sizes:

- B6 ... B24

Replacement latch, plastic, for HEAVYCON housing in sizes:

- D7

Ordering data		
Type	Order No.	Pcs. / Pkt.
HC-STA-B06-SL-PLBK	1412591	1
HC-STA-B10-SL-PLBK	1412804	1
HC-STA-B16-SL-PLBK	1412284	1
HC-STA-B24-SL-PLBK	1412885	1
HC-STA-B10-24-DL-PLBK	1412886	1

Ordering data		
Type	Order No.	Pcs. / Pkt.
HC-D 7-LB-KU	1584680	10

Replacement bolt and sealing screw



Replacement bolt



Sealing screw

	Technical data			Technical data		
Material data						
Material	Steel, galvanized			Steel, galvanized		
	Ordering data			Ordering data		
Description	Type	Order No.	Pcs. / Pkt.	Type	Order No.	Pcs. / Pkt.
Replacement bolt , steel, for HEAVYCON HC-B...-TFL... sleeve housing (not EMC housing) in size: B48 M3 sealing screw , IP65, for HEAVYCON standard housing in size: D7	HC-B 48-LB ERSBOLZ	1636114	10	HC-D 7-DS-IP65	1686229	100

EVO unlocking for EVO plastic housing



Water pump pliers

	Technical data		
Material data			
Material	-		
	Ordering data		
Description	Type	Order No.	Pcs. / Pkt.
Water pump pliers , with groove joint, gripping surfaces with dual notching, acc. to VDE ISO 8976, size: 240 mm	UNIFOX-WP	1212365	1

Heavy-duty connectors

DUPLICON stackable power distribution



DUPLICON is a consistent power distributor system for 6 x 4 mm² + PE conductors (25 A/400/690 V), from the busbar to ST-COMBI in the control cabinet right up to the PCB or plug-in connection on the power load. The system has a minimum of components and handling is extremely flexible. The robust metal housings with vibration-resistant locking latches means that DUPLICON is qualified for the harshest operating conditions.

The design meets the requirements for IP67 protection. The contact inserts have a capacitive PE contact and the screw connections can be assembled using standard tools. DUPLICON acts as an interface between the control cabinet and the device or actuators/drives. With additional connection options of 24 V or two-wire bus lines for AS-i or PROFIBUS,

DUPLICON also provides a connection to the signal world, which opens up a broad range of possible applications.

Thanks to the plug-in design, all cables can be conveniently assembled in the workshop and quickly connected together in the system. All connections are touch-proof according to DIN VDE 0105 and meet the requirements of BGV A2 accident prevention regulations.

i Your web code: #0004

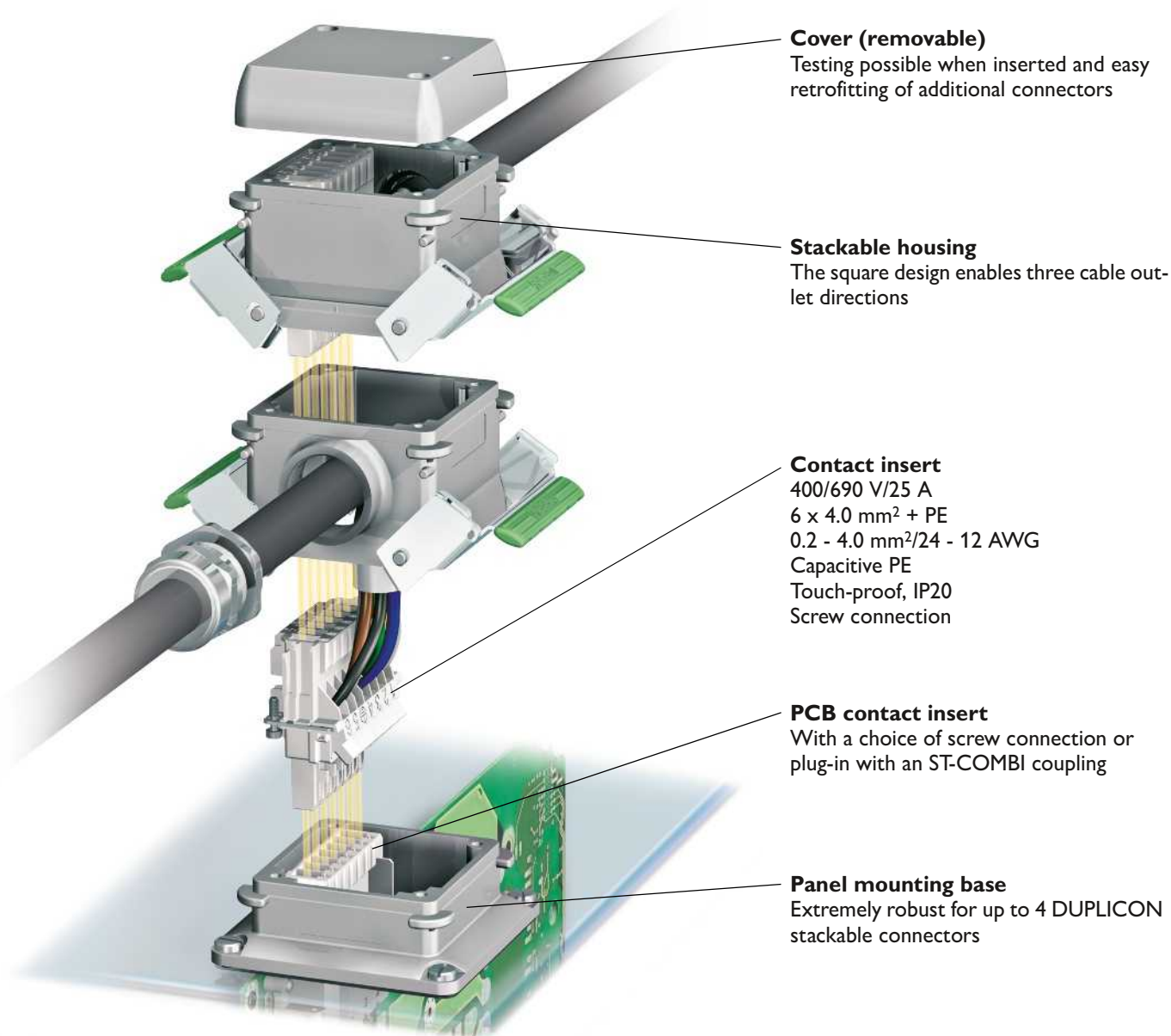

Stationary power distribution

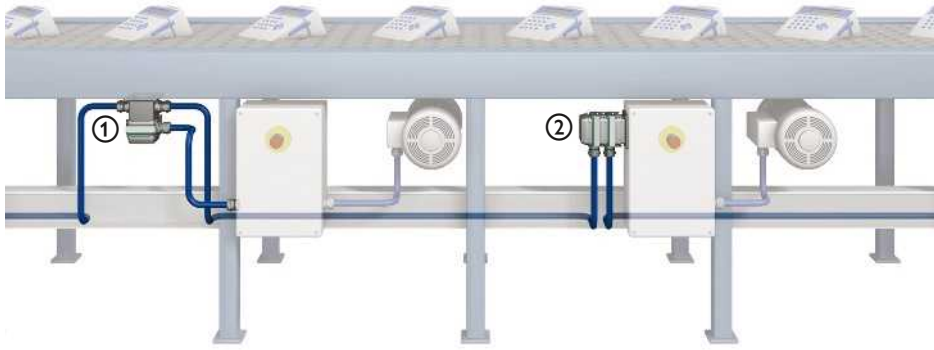

There are essentially two DUPLICON options for stationary power distribution:
 ① Using the T-box, which is installed permanently next to the power load and has a plug-in cable outlet.
 ② Using a stackable device connection. Direct device connection is always the best

option, but this requires design-based integration.

The main advantages are separate plug-in capability of the cables during startup and uninterrupted device replacement during future servicing.

Modular power distribution

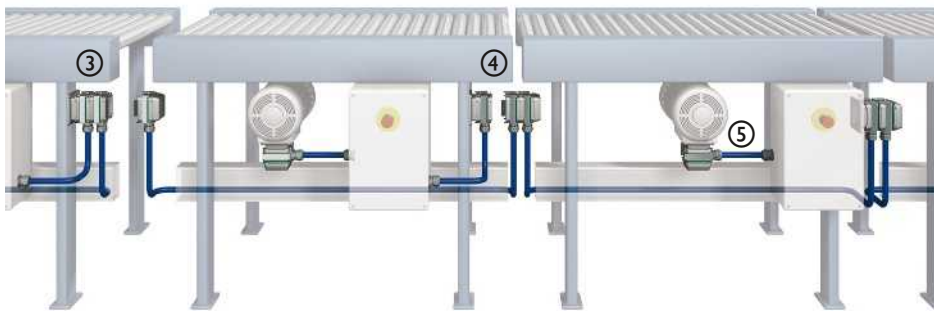

③ Your power distribution can be configured in advance, thanks the stackable design. Plug and Play ensures quick and reliable startup.

④ During servicing, the main power cable is disconnected from the load without causing any interruption and the system continues running.

⑤ DUPLICON is also suitable for use as a motor connector. The square design enables different cable outlet directions and the vibration-resistant locking mechanism can withstand the harshest operating conditions.

The modular contact inserts offer a wide range of possible applications.

Cable routing options



With hybrid cables

In the classic and simplest case, one cable is introduced per stackable housing. With the aid of an M25 adapter screw connection, cables with a diameter of up to 21 mm can be connected.



With separate cables

The cable glands with two holes allow thin power and 24 V cables to be routed separately into stackable housing.



With opposing cables

Housings with two cable entries allow cables with larger diameters or combinations, e.g., with AS-i cables or PROFIBUS, to be routed in.

Heavy-duty connectors

DUPLICON stackable power distribution

Connector sets

Suitable standard and EMC cable glands can be found in the Installation and mounting material section.

Notes:
Cable glands, see starting with page 680
For accessories, refer to page: 664



**Stackable connector set
(stackable housing, contact insert)**



**Panel feed-through set
(panel mounting base, stackable housing,
2 contact inserts, housing cover)**



Technical data

Technical data	
Electrical data in acc. with IEC 61076-2-101	
Rated voltage (III/3)	400 V (L-PE) / 690 V (L-L)
Rated surge voltage	6 kV
Rated current	25 A
Surge voltage category/pollution degree	III / 3
Contact resistance	1.5 mΩ
Material data	
Housing material	Aluminum die-cast
Housing surface material	EMC-conductive
Seal material	NBR
Locking latch material	Stainless steel
Contact material	Cu
Contact surface material	Ag
Contact carrier material	PA
Material grip body interlock	PA
Inflammability class according to UL 94	V0
Mechanical data	
Degree of protection	IP65/IP66/IP67
Insertion/withdrawal cycles	≥ 100
Connection data	
Connection method	Screw connection
Stripping length of the individual wire	10 mm
Conductor cross section	0.2 mm ² ... 4 mm ² (6 mm ² without ferrule)
Connection cross section AWG	24 ... 12 (AWG 10 without ferrule)
Tightening torque	0.5 Nm ... 0.6 Nm
Temperature data	
Ambient temperature (operation)	-40 °C ... 100 °C



Technical data

Technical data	
Electrical data in acc. with IEC 61076-2-101	
Rated voltage (L-PE) / 690 V (L-L)	400 V (L-PE) / 690 V (L-L)
Rated surge voltage	6 kV
Rated current	25 A
Surge voltage category/pollution degree	III / 3
Contact resistance	1.5 mΩ
Material data	
Housing material	Aluminum die-cast
Housing surface material	EMC-conductive
Seal material	NBR
Locking latch material	Stainless steel
Contact material	Cu
Contact surface material	Ag
Contact carrier material	PA
Material grip body interlock	PA
Inflammability class according to UL 94	V0
Mechanical data	
Degree of protection	IP65/IP66/IP67
Insertion/withdrawal cycles	≥ 100
Connection data	
Connection method	Screw connection
Stripping length of the individual wire	10 mm
Conductor cross section	0.2 mm ² ... 4 mm ² (6 mm ² without ferrule)
Connection cross section AWG	24 ... 12 (AWG 10 without ferrule)
Tightening torque	0.5 Nm ... 0.6 Nm
Temperature data	
Ambient temperature (operation)	-40 °C ... 100 °C

Ordering data

Description		
DUPLICON sets, stackable housing without cable screw connection		
With M20 thread		
With M25 thread		

Type	Order No.	Pcs. / Pkt.
DC-B 6-SET-HD-M20-M-7X4-UT	1602216	1
DC-B 6-SET-HD-M25-M-7X4-UT	1602229	1

Ordering data

Type	Order No.	Pcs. / Pkt.
DC-B 6-SET-WF-M20R-M-7X4-UT	1602232	1
DC-B 6-SET-WF-M25R-M-7X4-UT	1602258	1

Accessories

Special cable screw connection M25, brass		
With 10 mm and 11 mm hole		

HC-M-KV-M25(1X10/1X11)	1580228	10
------------------------	---------	----

Accessories

HC-M-KV-M25(1X10/1X11)	1580228	10
------------------------	---------	----

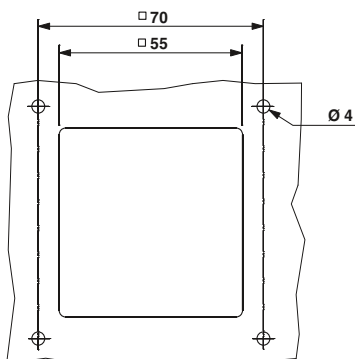

Panel cutout: DC-B 6-SET-WF...

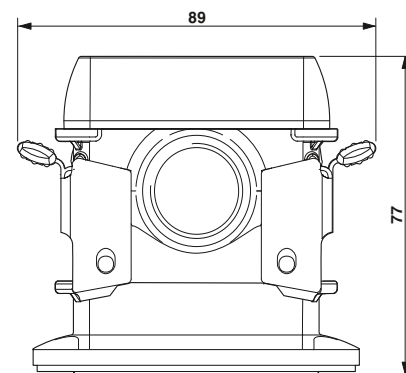
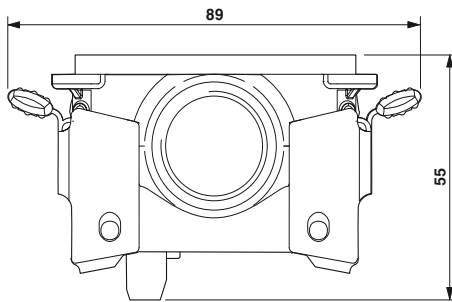



Coupling set
(basic housing, 2 stackable housings,
2 contact inserts, housing cover)



Distributor set
(basic housing, 3 stackable housings,
3 contact inserts, housing cover)

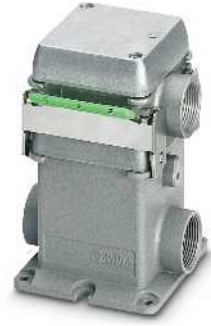

T-box set
(T-box with contact insert, stackable housing
with contact insert, housing cover)



Technical data

400 V (L-PE) / 690 V (L-L)
6 kV
25 A
III / 3
1.5 mΩ
Aluminum die-cast
EMC-conductive
NBR
Stainless steel
Cu
Ag
PA
PA
V0
IP65/IP66/IP67
≥ 100
Screw connection
10 mm
0.2 mm ² ... 4 mm ² (6 mm ² without ferrule)
24 ... 12 (AWG 10 without ferrule)
0.5 Nm ... 0.6 Nm
-40 °C ... 100 °C

Technical data

400 V (L-PE) / 690 V (L-L)
6 kV
25 A
III / 3
1.5 mΩ
Aluminum die-cast
EMC-conductive
NBR
Stainless steel
Cu
Ag
PA
PA
V0
IP65/IP66/IP67
≥ 100
Screw connection
10 mm
0.2 mm ² ... 4 mm ² (6 mm ² without ferrule)
24 ... 12 (AWG 10 without ferrule)
0.5 Nm ... 0.6 Nm
-40 °C ... 100 °C

Technical data

400 V (L-PE) / 690 V (L-L)
6 kV
25 A
- / 3
1.5 mΩ
Aluminum die-cast
EMC-conductive
NBR
Stainless steel
Cu
Ag
PA
PA
V0
IP65/IP66/IP67
≥ 100
Screw connection
10 mm
0.2 mm ² ... 4 mm ² (6 mm ² without ferrule)
24 ... 12
0.5 Nm ... 0.6 Nm
-40 °C ... 100 °C

Ordering data

Type	Order No.	Pcs. / Pkt.
DC-B 6-SET-CO-M20-M-7X4-UT	1602274	1
DC-B 6-SET-CO-M25-M-7X4-UT	1602287	1

Ordering data

Type	Order No.	Pcs. / Pkt.
DC-B 6-SET-3D-M20-M-7X4-UT	1602290	1
DC-B 6-SET-3D-M25-M-7X4-UT	1602300	1

Ordering data

Type	Order No.	Pcs. / Pkt.
DC-B 6-SET-TB-M20-M-7X4-UT	1581023	1
DC-B 6-SET-TB-M25-M-7X4-UT	1581036	1

Accessories

HC-M-KV-M25(1X10/1X11)	1580228	10
------------------------	---------	----

Accessories

HC-M-KV-M25(1X10/1X11)	1580228	10
------------------------	---------	----

Accessories

HC-M-KV-M25(1X10/1X11)	1580228	10
------------------------	---------	----

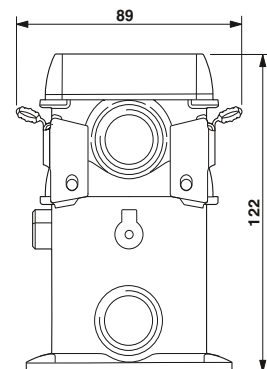
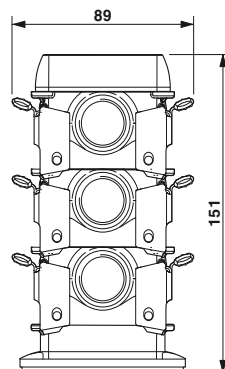
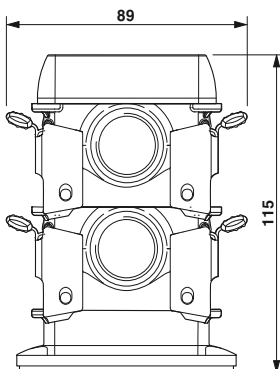

Heavy-duty connectors

DUPLICON stackable power distribution

Contact inserts



With the stackable contact inserts, the power conductors for modular mechanical and plant engineering can be pre-assembled and combined on-site to form power distributors quickly, easily and reliably.

The T-Box contact insert is predestined for stationary installations. With two connections per position, it serves to loop through power conductors on site.

Compared to the DUPLICON 3-way distributor, the T-Box connectors save 20% on height and permit one to dispense with a full set of stackable connectors.

DUPLICON is the first IP67 connector that can be tested from the outside while it is plugged in. All that is necessary is to unscrew both screws in the cover, after which all the contacts will be immediately accessible to conventional testing devices. For safety reasons, all the contacts are IP20 touch proof in acc. with DIN VDE 0105.

Note:

Coding stars with 4 coding branches are available for the purpose of coding several connectors of the same kind against being plugged in incorrectly, Order No. **3040588**.

EB 2-6 dual insertion bridges with a 2 mm pitch (Order No. **0201155**) are available for bridging two adjacent connections.

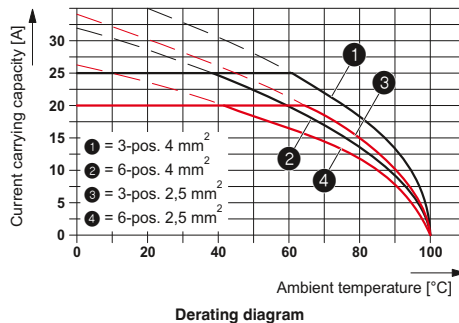

Technical data

Electrical data in acc. with IEC 61076-2-101

Rated voltage (III/3)
 Rated surge voltage
 Rated current
 Surge voltage category/pollution degree
 No. of pos.

Material data

Contact material
 Contact surface material
 Contact carrier material
 Inflammability class according to UL 94

Mechanical data

Degree of protection
 Insertion/withdrawal cycles

Connection data

Connection method
 Stripping length of the individual wire
 Conductor cross section
 Connection cross section AWG
 Tightening torque

Temperature data

Ambient temperature (operation)



Stacked contact insert

Technical data

400 V (L-PE) / 690 V (L-L)
 6 kV
 25 A
 III / 3
 6

Cu
 Ag
 PA
 V0

IP20, touch proof
 ≥ 100

Screw connection
 10 mm
 0.2 mm² ... 4 mm² (6 mm² without ferrule)
 24 ... 12 (AWG 10 without ferrule)
 0.5 Nm ... 0.6 Nm

-40 °C ... 100 °C

Ordering data

Type	Order No.	Pcs. / Pkt.
DC-B 6-ID-7X4-UT	1602203	10

Accessories

PC	3040588	50
EB 2-6	0201155	100

Description

Stacked contact insert, 6 x 4 mm² + PE

Screw connection

T-Box contact insert, 6 x 4 mm² + PE

With two screw connections per position

Panel mounting contact insert, 6 x 4 mm² + PE

180° PCB connection

Panel mounting contact insert, 6 x 4 mm² + PE

90° PCB connection

Coding star, with four coding branches, to code the connector

Insertion bridge, insulated

Replacement screws

M3 screw, V2A, for fixing the contact inserts for PCB connection in the panel mounting base

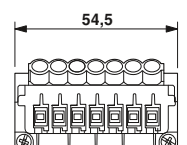
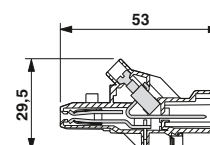

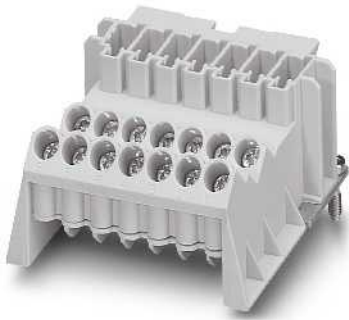

T-Box contact insert



Panel mounting contact insert,
180° PCB connection



Panel mounting contact insert,
90° PCB connection



Technical data

400 V (L-PE) / 690 V (L-L)
6 kV
25 A
III / 3
6

Cu
Ag
PA
V0

IP20, touch proof
≥ 100

Screw connection
10 mm
0.2 mm² ... 4 mm² (6 mm² without ferrule)
24 ... 12 (AWG 10 without ferrule)
0.5 Nm ... 0.6 Nm

-40 °C ... 100 °C

Technical data

400 V (L-PE) / 690 V (L-L)
6 kV
25 A
III / 3
6

Cu
Ag
PA
V0

IP20, touch proof
≥ 100

Solder connection
-
-
-
-

-40 °C ... 100 °C

Technical data

400 V (L-PE) / 690 V (L-L)
6 kV
25 A
III / 3
6

Cu
Ag
PA
V0

IP20, touch proof
≥ 100

Solder connection
-
-
-
-

-40 °C ... 100 °C

Ordering data

Type	Order No.	Pcs. / Pkt.
DC-B 6-IBT-7X4-UT	1581065	10

Ordering data

Type	Order No.	Pcs. / Pkt.
DC-B 6-IB-7X4-PCB-180	1602177	10

Ordering data

Type	Order No.	Pcs. / Pkt.
DC-B 6-IB-7X4-PCB- 90	1602180	10

Accessories

PC	3040588	50
EB 2- 6	0201155	100

Accessories

PC	3040588	50
VC-TR-S	1607826	50
DC-PCB-M3X20	1602407	100

Accessories

PC	3040588	50
VC-TR-S	1607826	50
DC-PCB-M3X20	1602407	100

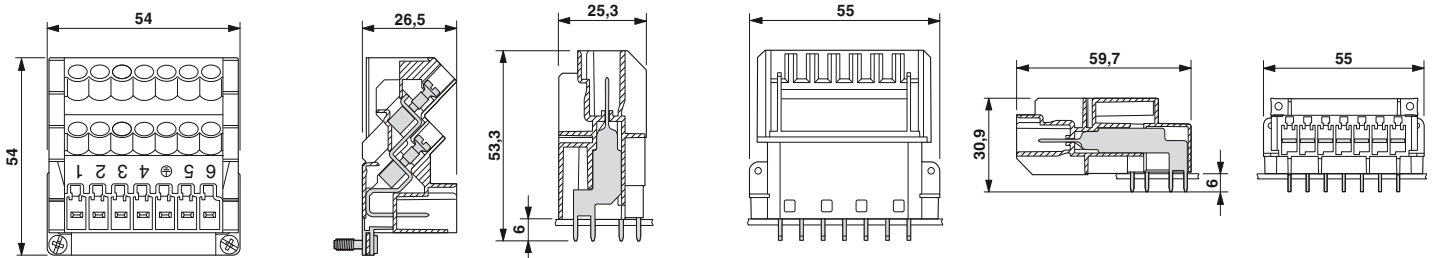

Heavy-duty connectors

DUPLICON stackable power distribution

Housing

Notes:

Cable glands, see from page 680



Housing cover



Panel mounting base with open bottom



Technical data

Technical data
Material data
Housing material
Housing surface material
Seal material
Locking latch material
Material grip body interlock
Mechanical data
Degree of protection
Temperature data
Ambient temperature (operation)

Aluminum die-cast
EMC-conductive
NBR
-
-
IP65/IP66/IP67
-40 °C ... 125 °C



Technical data

Aluminum die-cast
EMC-conductive
NBR
-
-
IP65/IP66/IP67
-40 °C ... 125 °C

Ordering data

Description
Aluminum housing cover
Aluminum panel mounting base, with open base
Aluminum basic housing with enclosed base
Aluminum stackable housing
With 2 x M20 thread
With 2 x M25 thread
With 1 x M20 thread
With 1 x M25 thread
T-Box housing
With 2 x M20 thread
With 2 x M25 thread

Type	Order No.	Pcs. / Pkt.
DC-B 6-CT-M	1602025	10
DC-B 6-HB-M	1602038	10

Ordering data

Type	Order No.	Pcs. / Pkt.
DC-B 6-HB-M	1602038	10

Accessories

Special cable screw connection M25, brass
With 10 mm and 11 mm hole

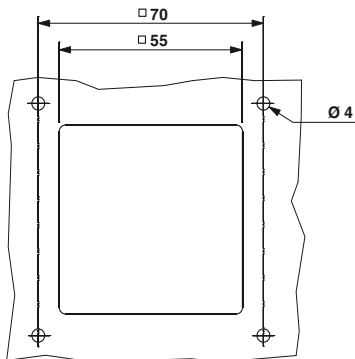

Panel cutout: DC-B 6-HB-M

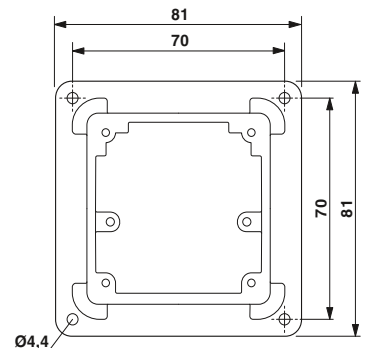
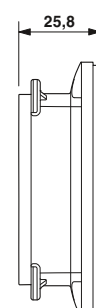
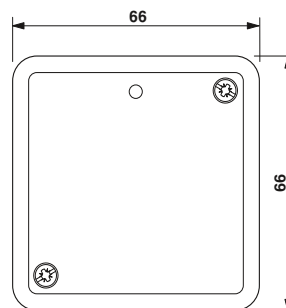



**Base housing
with closed bottom**



**Stackable housing
without cable gland**



T-Box, box mounting base



Technical data

Aluminum die-cast
EMC-conductive
-
-

IP65/IP66/IP67

-40 °C ... 125 °C

Ordering data

Type	Order No.	Pcs. / Pkt.
DC-B 6-HM-M	1602164	10

Accessories

--	--	--

Technical data

Aluminum die-cast
EMC-conductive
NBR
Stainless steel
PA

IP65/IP66/IP67

-40 °C ... 125 °C

Ordering data

Type	Order No.	Pcs. / Pkt.
DC-B 6-HD-M20/M20-M	1602067	10
DC-B 6-HD-M25/M25-M	1602070	10
DC-B 6-HD-M20-M	1602041	10
DC-B 6-HD-M25-M	1602054	10

Accessories

HC-M-KV-M25(1X10/1X11)	1580228	10
------------------------	---------	----

Technical data

Aluminum die-cast
EMC-conductive
-
-

IP65/IP66/IP67

-40 °C ... 125 °C

Ordering data

Type	Order No.	Pcs. / Pkt.
DC-B 6-HTC-M20-M20-M	1581049	10
DC-B 6-HTC-M25-M25-M	1581052	10

Accessories

HC-M-KV-M25(1X10/1X11)	1580228	10
------------------------	---------	----

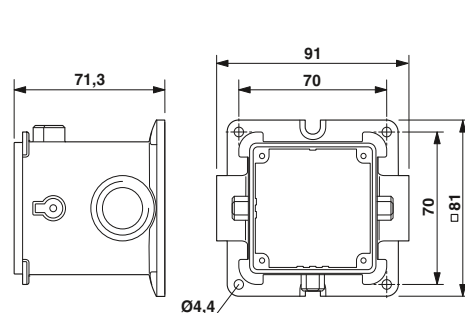
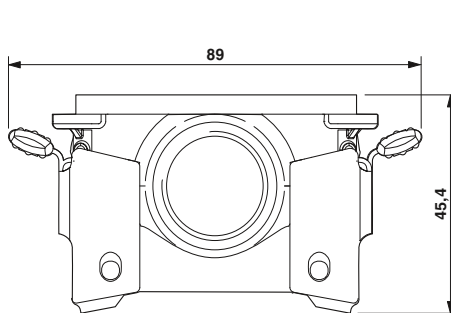
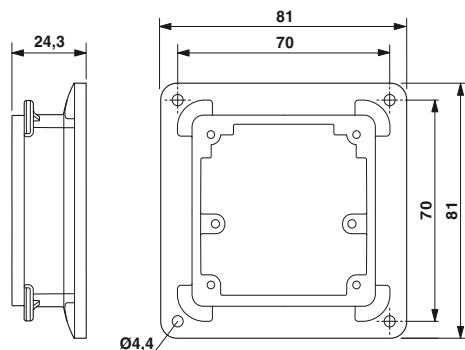

Heavy-duty connectors

DUPLICON stackable power distribution

Motor connector, sleeve housing, EMC-protected

Notes:
Cable glands, see from page 680
For accessories, refer to page: 664



Sleeve housing, one cable entry, without cable gland



Sleeve housing, two cable entries, without cable gland

Technical data
Material data
Housing material
Housing surface material
Seal material
Locking latch material
Material grip body interlock
Mechanical data
Degree of protection
Temperature data
Ambient temperature (operation)

ERC

Technical data	
Housing material	Aluminum die-cast
Housing surface material	EMC-conductive
Seal material	NBR
Locking latch material	Stainless steel
Material grip body interlock	PA
Degree of protection	IP65/IP66/IP67
Ambient temperature (operation)	-40 °C ... 125 °C

ERC

Technical data	
Housing material	Aluminum die-cast
Housing surface material	EMC-conductive
Seal material	NBR
Locking latch material	Stainless steel
Material grip body interlock	PA
Degree of protection	IP65/IP66/IP67
Ambient temperature (operation)	-40 °C ... 125 °C

Description
Sleeve housing, with one cable entry
1 x M20, straight
1 x M20, lateral
1 x M25, straight
1 x M25, lateral
1 x M32, straight
1 x M32, lateral
Sleeve housing, with two cable entries
2 x M20, straight
2 x M20, lateral
2 x M25, straight
2 x M25, lateral

Ordering data		
Type	Order No.	Pcs. / Pkt.
DC-B 6-H-80/O1STM20G-M	1581173	10
DC-B 6-H-80/O1STM20S-M	1581117	10
DC-B 6-H-80/O1STM25G-M	1581194	10
DC-B 6-H-80/O1STM25S-M	1581138	10
DC-B 6-H-80/O1STM32G-M	1581215	10
DC-B 6-H-80/O1STM32S-M	1581159	10

Ordering data		
Type	Order No.	Pcs. / Pkt.
DC-B 6-H-80/O2STM20G-M	1581180	10
DC-B 6-H-80/O2STM20S-M	1581124	10
DC-B 6-H-80/O2STM25G-M	1581201	10
DC-B 6-H-80/O2STM25S-M	1581145	10

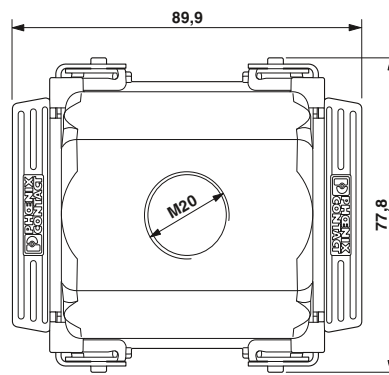

Dimensional drawing with straight cable outlet

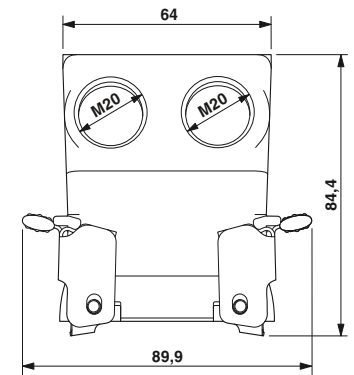

Dimensional drawing with lateral cable outlet

Motor connector, hinged retaining frame



Notes:
For contact insert modules, see from page: 548



Hinged retaining frame

DUPLICON Modular has been designed for use in drives in the power distribution field. The square-shaped housing allows flexible cable outlet directions and the absolutely vibration-free locking latch can withstand the roughest of conditions. The requirements as per railway standard EN 50155 are markedly overshoot.

The modularity of contact inserts from the HEAVYCON field offers numerous applications.

The hinged retaining frames have been designed with leading PE contacts and can accommodate up to 3 contact insert modules.

The housings have one or two conductor entries in different sizes, depending on the type of cable entry.

Material data	
Hinged retaining frame material	Die-cast zinc alloy
Connection data	
Connection cross section	[mm ²] 4 ... 6
Connection cross section	[mm ²] 1 ... 2.5
Connection cross section	AWG 12 ... 10 (for PE conductor – power side)
Connection cross section	AWG 18 ... 14 (for PE conductor – control side)
Temperature data	
Ambient temperature (operation)	-40 °C ... 125 °C

Description	
Hinged retaining frame , for sleeve housing, marking: upper case letters (A, B, C, ...)	
Hinged retaining frame , for panel mounting base, marking: lower case letters (a, b, c, ...)	
Cable lug	
PE extension to 16 mm ²	

Cable lug	
PE extension to 16 mm ²	
Coding elements	
see from page 638	

ERIC

Technical data

Material data	
Die-cast zinc alloy	
Connection data	
Connection cross section	[mm ²] 4 ... 6
Connection cross section	[mm ²] 1 ... 2.5
Connection cross section	AWG 12 ... 10 (for PE conductor – power side)
Connection cross section	AWG 18 ... 14 (for PE conductor – control side)
Temperature data	
-40 °C ... 125 °C	

Ordering data

Type	Order No.	Pcs. / Pkt.
DC-B 6-MHR-T3	1581285	10
DC-B 6-MHR-A3	1581287	10
HC-M-MHR-PE16	1636981	50

Accessories

HC-M-MHR-PE16	1636981	50
see from page 638		

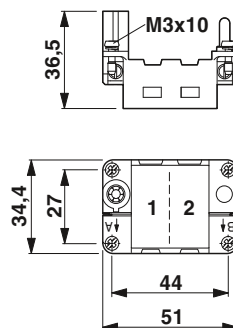

Heavy-duty connectors

DUPLICON stackable power distribution

Accessories

The DUPLICON-M12 adapter can be used to tap 24 V branches for active sensor/actuator boxes on site. The 5-pos. M12 connectors have thus been pre-wired only parallel to the connectors.



M12 adapters



Mounting brackets

Technical data

Material data

Material
Housing material
Housing surface material
Material, protective cover
Seal material
Locking latch material
Material grip body interlock

Mechanical data

Color
Type
Degree of protection
Tightening torque
Temperature data
Ambient temperature (operation)

ERC

Technical data

-
Aluminum die-cast
EMC-conductive
-
NBR
Stainless steel
PA

Pearl gray
DC-B6
IP65/IP66/IP67
-

-40 °C ... 100 °C

ERC

Technical data

Stainless steel V2A
-
-
-
-
-

Gray
DC-B6
-
-

-

Ordering data

Description

M12 adapter for low-voltage distribution, A-coded

Mounting bracket, made of 3 mm stainless steel plate, with predrilled holes, with long and short sides

M4 Torx® screw T20, 12 mm long, self tapping, consisting of high-strength steel, anti-corrosive, for housing assembly

Profile gasket for stackable housing

Flat seal for panel mounting base

Dust protection cover, for snapping on, with retaining cord eyelet, can be painted over

Type

DC-B 6-ADP-4M12-FS-5CON-7X4-UT

Order No.

1581010

Pcs. / Pkt.

1

Type

DC-B 6-A-SA

Order No.

1602313

Pcs. / Pkt.

5

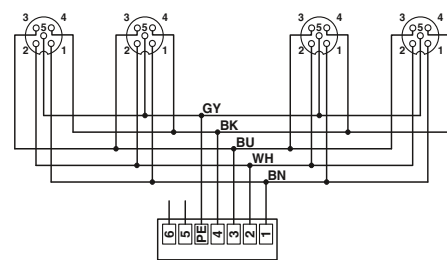

Circuit diagram

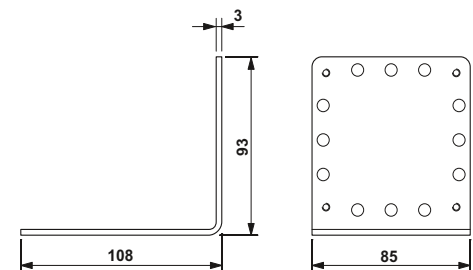
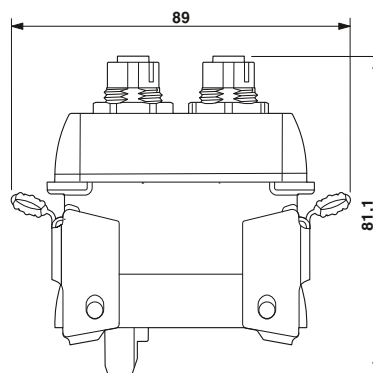



Screw



Replacement seals



Dust protection cover

ERC

ERC

Technical data			Technical data			Technical data		
Steel	-	-	-	-	-	-	-	-
-	-	-	-	-	-	-	-	-
-	-	-	-	-	-	-	-	-
-	-	-	NBR	-	-	Polyamide	-	-
-	-	-	-	-	-	-	-	-
Chromated	-	-	Black	-	-	Black	-	-
-	-	-	DC-B6	-	-	DC-B6	-	-
-	-	-	-	-	-	IP54	-	-
1.5 Nm ... 2 Nm	-	-	-	-	-	-	-	-
-	-	-	-	-	-	-40 °C ... 100 °C	-	-
-	-	-	-	-	-	-	-	-
Ordering data			Ordering data			Ordering data		
Type	Order No.	Pcs. / Pkt.	Type	Order No.	Pcs. / Pkt.	Type	Order No.	Pcs. / Pkt.
T20-M4X12	1602410	100	DC-B 6-A-HD-G	1602326	10			
			DC-B 6-A-HB-G	1602339	10			
						DC-B 6-CT-P	1581078	10

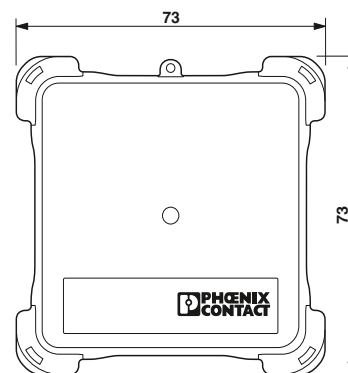



Installation and mounting material

Cable entry systems are in demand as an efficient alternative to heavy-duty connectors and cable glands. They can be used to route assembled cables directly into the control cabinet, to devices, and onto DIN rails without an additional plug-in connection. With the CES cable entry system, Phoenix Contact offers a well-designed system solution from system and field cabling to the DIN rail.

Plug assembly frames from Phoenix Contact can be easily mounted on standard DIN rails and so save entire jumpering levels in the control cabinet. They accommodate pre-assembled contact inserts and can be combined with HEAVYCON STANDARD sleeve housings. Thanks to the robust, conductive die-cast aluminum design, capacitive PE contact is ensured.

Clear and permanent marking of all cables and distributor boxes considerably improves transparency in control cabinets and systems. It makes assembly and maintenance work easier and assists in rectifying faults. Phoenix Contact cable marking systems provide the ideal marking option for any application. Just select an assembly method. The markers can be threaded on, clipped on, adhered in place or secured with cable binders.

 **Your web code: #0005**

CES cable entry system

Sealing frames	668
Rubber cable sleeves	670
Plastic cable sleeves	672
Accessories	674

Cable feed-throughs

CES Multigates cable feed-throughs	676
Floor panels	677
Cable feed-throughs	678

Plug assembly frames

Cable glands

Plastic and brass cable glands	680
Cable glands for Ex protection	697

Service interfaces

Marking systems, tools, and mounting material



Sealing frame with locking latch

- Sealing frame with integrated metal reinforcement to protect against deformation
- Only two locking elements are required (screws or latch)
- Suitable for standard panel cutouts (e.g., Rittal)
- Snap-on frame for simplifying on-site installation
- Sealing frame with convenient locking latch for tool-free actuation
- Marking for cable sleeve location on the underside of the frame

Notes:
 For dimensional drawings, see page 675
 If the panel cutout width is 51 mm, HC industrial connectors and CIF plug assembly frames can also be fed through the panel using the cable entry system (CES).

General data	
Material of frames	Polyamide
Material of cable sleeves	-
Degree of protection	IP54
Torque	-
Inflammability class according to UL 94	V0
Temperature range	-40 ... 120 [°C]



Technical data	
Material of frames	Polyamide
Material of cable sleeves	-
Degree of protection	IP54
Torque	-
Inflammability class according to UL 94	V0
Temperature range	-40 ... 120 [°C]

Description
Sealing frame , including flat gasket, for accommodating cable sleeves, for standard cutout: B10 (cutout: 35 mm x 65 mm), for up to 6 cable sleeves B16 (cutout: 35 mm x 86 mm), for up to 8 cable sleeves B24 (cutout: 35 mm x 113 mm), for up to 10 cable sleeves
Pre-assembled sealing frames with cone-shaped cable sleeves , for cables with a diameter of 2 mm ... 11 mm, for standard cutouts: B16 (cutout: 36 mm x 86 mm) B24 (cutout: 36 mm x 113 mm)
Snap-on frame , including integrated seal for mounting panel, for accommodating sealing frames, for standard cutouts: B10 (cutout: 35 mm x 65 mm) B16 (cutout: 35 mm x 86 mm) B24 (cutout: 35 mm x 113 mm)

Ordering data		
Type	Order No.	Pcs. / Pkt.
CES-B10-HFFS-PLBK	0801663	1
CES-B16-HFFS-PLBK	0801662	1
CES-B24-HFFS-PLBK	0801661	1

Replacement flat gasket , for sealing frame with standard cutout: B10 (cutout: 35 mm x 65 mm) B16 (cutout: 35 mm x 86 mm) B24 (cutout: 35 mm x 113 mm)
Locking plate , metal, locks an unused snap-up frame, transport protection, for standard cutouts: B10 B16 B24
Electrician's scissors , high cutting performance, thanks to micro-serrated cutting area, suitable for copper, aluminum, Kevlar fibers, and plastic, two-component non-slip soft-grip handles, ergonomic design, adjustable screw joint
M4 replacement locking screw , with 3 mm Allen screw head, for sealing frame with screw locking
Bit screwdriver , with 1/4" quick-action chuck, suitable for bits according to DIN 3126-C 6.3 and E 6.3/ISO 1173, magnetic
Screw bit , hexagonal, E6.3-1/4" drive, hardened, suitable for holder according to DIN 3126-F 6.3/ISO 1173, size: hex 3 x 50 mm Size: hex 3 x 50 mm

Accessories		
Type	Order No.	Pcs. / Pkt.
CES-B10-WRG-BK	0801725	10
CES-B16-WRG-BK	0801726	10
CES-B24-WRG-BK	0801727	10



Sealing frame with screw locking



Sealing frames with cone-shaped cable sleeves and screw locking



Snap-up frame



Technical data		
Polyamide		
-		
IP54 / IP65 (when using a CES-SRC../CES-LRC.. cone sleeve and a cable binder)		
2 Nm ... 4 Nm (locking screw)		
V0		
-40 ... 120		

Technical data		
Polyamide		
NBR		
IP54 (DIN IEC 60529)		
2 Nm ... 4 Nm (locking screw)		
-		
-40 ... 120		

Technical data		
Polyamide		
-		
IP54		
-		
V0		
-20 ... 80		

Ordering data		
Type	Order No.	Pcs. / Pkt.
CES-B10-SFFS-PLBK	0801660	1
CES-B16-SFFS-PLBK	0801659	1
CES-B24-SFFS-PLBK	0801658	1

Ordering data		
Type	Order No.	Pcs. / Pkt.
CES-B16-8XSRC-BK	1411073	1
CES-B24-10XSRC-BK	1411074	1

Ordering data		
Type	Order No.	Pcs. / Pkt.
CES-B10-SF-PLBK	0801655	10
CES-B16-SF-PLBK	0801651	10
CES-B24-SF-PLBK	0801647	10

Accessories		
Type	Order No.	Pcs. / Pkt.
CES-B10-WRG-BK	0801725	10
CES-B16-WRG-BK	0801726	10
CES-B24-WRG-BK	0801727	10
CES-SFFS-H	0801728	10
SF-M BH	1212070	1
SF-BIT-HEX 3-50	1212647	5

Accessories		
Type	Order No.	Pcs. / Pkt.
CUTFOX-ES	1212621	1
CES-SFFS-H	0801728	10
SF-M BH	1212070	1
SF-BIT-HEX 3-50	1212647	5

Accessories		
Type	Order No.	Pcs. / Pkt.
CES-B10-SFC-M	0801645	10
CES-B16-SFC-M	0801642	10
CES-B24-SFC-M	0801641	10

Installation and mounting material

CES cable entry system

Cable sleeves, rubber

Advantages:

- Significantly improved long-term performance
- Resistant to oil, fuels, and grease
- Halogen-free

Notes:

The CES cable entry system was developed according to DIN EN 50262 (Cable glands for electrical installations).

The cable sleeves must be mounted in accordance with the mounting instructions provided.



Cable sleeves, small



Cable sleeves, large

General data			Technical data			Technical data		
Material			NBR			NBR		
Degree of protection			IP54			IP54		
Temperature range		[°C]	-40 ... 125			-40 ... 125		
Description			Ordering data			Ordering data		
	Color		Type	Order No.	Pcs. / Pkt.	Type	Order No.	Pcs. / Pkt.
Cone-shaped cable sleeves , IP65 in sealing frames with screw locking and cable binders, IP54 in sealing frames with locking latch. For cables with a diameter of:								
2 mm ... 11 mm	black		CES-SRC-BK	0801718	10	CES-LRC-BK	0801719	10
7 mm ... 24 mm	black							
Cable sleeves, IP65, without bore hole , can be used in sealing frames with locking latch and screw locking								
	black		CES-SRG-BK	0801670	10	CES-LRG-BK	0801671	10
Cable sleeves, small, slotted , can be used in sealing frames with locking latch and screw locking, for cable diameter of:								
1 mm ... 2 mm	black		CES-SRG-BK-2	0801635	10			
2 mm ... 3 mm	black		CES-SRG-BK-3	0801633	10			
3 mm ... 4 mm	black		CES-SRG-BK-4	0801632	10			
4 mm ... 5 mm	black		CES-SRG-BK-5	0801630	10			
5 mm ... 6 mm	black		CES-SRG-BK-6	0801628	10			
6 mm ... 7 mm	black		CES-SRG-BK-7	0801627	10			
7 mm ... 8 mm	black		CES-SRG-BK-8	0801625	10			
8 mm ... 9 mm	black		CES-SRG-BK-9	0801622	10			
9 mm ... 10 mm	black		CES-SRG-BK-10	0801620	10			
10 mm ... 11 mm	black		CES-SRG-BK-11	0801618	10			
11 mm ... 12 mm	black		CES-SRG-BK-12	0801617	10			
12 mm ... 13 mm	black		CES-SRG-BK-13	0801616	10			
13 mm ... 14 mm	black		CES-SRG-BK-14	0801615	10			
14 mm ... 15 mm	black		CES-SRG-BK-15	1410563	10			
15 mm ... 16 mm	black		CES-SRG-BK-16	1410576	10			
16 mm ... 17 mm	black		CES-SRG-BK-17	1410589	10			
Cable sleeves, large, slotted , can be used in sealing frames with locking latch and screw locking, for cable diameter of:								
14 mm ... 15 mm	black					CES-LRG-BK-15	0801619	10
15 mm ... 16 mm	black					CES-LRG-BK-16	0801621	10
16 mm ... 17 mm	black					CES-LRG-BK-17	0801624	10
17 mm ... 18 mm	black					CES-LRG-BK-18	0801626	10
18 mm ... 19 mm	black					CES-LRG-BK-19	0801629	10
19 mm ... 20 mm	black					CES-LRG-BK-20	0801631	10
20 mm ... 21 mm	black					CES-LRG-BK-21	0801634	10
21 mm ... 22 mm	black					CES-LRG-BK-22	0801637	10
22 mm ... 23 mm	black					CES-LRG-BK-23	0801638	10
23 mm ... 24 mm	black					CES-LRG-BK-24	0801639	10
24 mm ... 25 mm	black					CES-LRG-BK-25	0801640	10
25 mm ... 26 mm	black					CES-LRG-BK-26	0801643	10
26 mm ... 27 mm	black					CES-LRG-BK-27	0801644	10
27 mm ... 28 mm	black					CES-LRG-BK-28	0801646	10
28 mm ... 29 mm	black					CES-LRG-BK-29	0801648	10
29 mm ... 30 mm	black					CES-LRG-BK-30	0801650	10
30 mm ... 31 mm	black					CES-LRG-BK-31	0801653	10
31 mm ... 32 mm	black					CES-LRG-BK-32	0801654	10
32 mm ... 33 mm	black					CES-LRG-BK-33	0801656	10

Cable sleeves, rubber, special formats

Advantages:

- Significantly improved long-term performance
- Resistant to oil, fuels, and grease
- Halogen-free

Notes:
The CES cable entry system was developed according to DIN EN 50262 (Cable glands for electrical installations).
The cable sleeves must be mounted in accordance with the mounting instructions provided.



Cable sleeves, small, with several bore holes



Cable sleeves, small, for AS interface cables

General data		Technical data			Technical data		
Material		NBR		NBR			
Degree of protection		IP54		-			
Temperature range	[°C]	-40 ... 125		-40 ... 125			
Description		Ordering data			Ordering data		
Description	Color	Type	Order No.	Pcs. / Pkt.	Type	Order No.	Pcs. / Pkt.
Cable sleeves, with 2 bore holes, small, slotted , can be used in sealing frames with locking latch and screw locking, for cable diameter of:							
2x 2 mm ... 3 mm	black	CES-SRG-BK-2X3	1410398	10			
2x 3 mm ... 4 mm	black	CES-SRG-BK-2X4	1410408	10			
2x 4 mm ... 5 mm	black	CES-SRG-BK-2X5	0801657	10			
2x 5 mm ... 6 mm	black	CES-SRG-BK-2X6	0801664	10			
2x 6 mm ... 7 mm	black	CES-SRG-BK-2X7	1410084	10			
2x 7 mm ... 8 mm	black	CES-SRG-BK-2X8	1410097	10			
2x 8 mm ... 9 mm	black	CES-SRG-BK-2X9	1410411	10			
Cable sleeves, with 4 bore holes, small, slotted , can be used in sealing frames with locking latch and screw locking, for cable diameter of:							
4 x 2 mm ... 3 mm	black	CES-SRG-BK-4X3	0801665	10			
4 x 3 mm ... 4 mm	black	CES-SRG-BK-4X4	0801666	10			
4 x 4 mm ... 5 mm	black	CES-SRG-BK-4X5	1410107	10			
4 x 5 mm ... 6 mm	black	CES-SRG-BK-4X6	1410152	10			
Cable sleeve, IP54, slotted, for one AS-Interface cable, cable arrangement:							
L	black				CES-SRG-BK-1ASI-L	1410042	10
R	black				CES-SRG-BK-1ASI-R	0801667	10
Cable sleeve, IP54, slotted, for two AS-Interface cables, cable arrangement:							
LL	black				CES-SRG-BK-2ASI-LL	1410055	10
RR	black				CES-SRG-BK-2ASI-RR	0801668	10
LR	black				CES-SRG-BK-2ASI-LR	0801669	10

Installation and mounting material

CES cable entry system

Cable sleeves, thermoplastics

Advantages:

- Low flammability according to UL 94 V0 of thermoplastic sleeves
- Good resistance to acids and lyes

Notes:
The CES cable entry system was developed according to DIN EN 50262 (Cable glands for electrical installations).
The cable sleeves must be mounted in accordance with the mounting instructions provided.



Cable sleeves, small



Cable sleeves, large



General data			Technical data			Technical data		
Material			SEBS			SEBS		
Degree of protection			IP44			IP44		
Inflammability class according to UL 94			V0			V0		
Temperature range		[°C]	-40 ... 80			-40 ... 80		
Ordering data			Ordering data			Ordering data		
Description	Color		Type	Order No.	Pcs. / Pkt.	Type	Order No.	Pcs. / Pkt.
Cable sleeves, small, slotted , can be used in sealing frames with locking latch and screw locking, for cable diameter of:								
1 mm ... 2 mm	gray		CES-STPG-GY-2	0801672	10			
2 mm ... 3 mm	gray		CES-STPG-GY-3	0801673	10			
3 mm ... 4 mm	gray		CES-STPG-GY-4	0801674	10			
4 mm ... 5 mm	gray		CES-STPG-GY-5	0801675	10			
5 mm ... 6 mm	gray		CES-STPG-GY-6	0801676	10			
6 mm ... 7 mm	gray		CES-STPG-GY-7	0801677	10			
7 mm ... 8 mm	gray		CES-STPG-GY-8	0801679	10			
8 mm ... 9 mm	gray		CES-STPG-GY-9	0801680	10			
9 mm ... 10 mm	gray		CES-STPG-GY-10	0801682	10			
10 mm ... 11 mm	gray		CES-STPG-GY-11	0801683	10			
11 mm ... 12 mm	gray		CES-STPG-GY-12	0801684	10			
12 mm ... 13 mm	gray		CES-STPG-GY-13	0801685	10			
13 mm ... 14 mm	gray		CES-STPG-GY-14	0801686	10			
14 mm ... 15 mm	gray		CES-STPG-GY-15	1410521	10			
15 mm ... 16 mm	gray		CES-STPG-GY-16	1410534	10			
16 mm ... 17 mm	gray		CES-STPG-GY-17	1410547	10			
Cable sleeves, large, slotted , can be used in sealing frames with locking latch and screw locking, for cable diameter of:								
14 mm ... 15 mm	gray					CES-LTPG-GY-15	0801687	10
15 mm ... 16 mm	gray					CES-LTPG-GY-16	0801688	10
16 mm ... 17 mm	gray					CES-LTPG-GY-17	0801689	10
17 mm ... 18 mm	gray					CES-LTPG-GY-18	0801690	10
18 mm ... 19 mm	gray					CES-LTPG-GY-19	0801691	10
19 mm ... 20 mm	gray					CES-LTPG-GY-20	0801692	10
20 mm ... 21 mm	gray					CES-LTPG-GY-21	0801693	10
21 mm ... 22 mm	gray					CES-LTPG-GY-22	0801695	10
22 mm ... 23 mm	gray					CES-LTPG-GY-23	0801696	10
23 mm ... 24 mm	gray					CES-LTPG-GY-24	0801697	10
24 mm ... 25 mm	gray					CES-LTPG-GY-25	0801698	10
25 mm ... 26 mm	gray					CES-LTPG-GY-26	0801699	10
26 mm ... 27 mm	gray					CES-LTPG-GY-27	0801700	10
27 mm ... 28 mm	gray					CES-LTPG-GY-28	0801701	10
28 mm ... 29 mm	gray					CES-LTPG-GY-29	0801702	10
29 mm ... 30 mm	gray					CES-LTPG-GY-30	0801703	10
30 mm ... 31 mm	gray					CES-LTPG-GY-31	0801705	10
31 mm ... 32 mm	gray					CES-LTPG-GY-32	0801706	10
32 mm ... 33 mm	gray					CES-LTPG-GY-33	0801707	10
Cable sleeves, IP65, without bore hole , can be used in sealing frames with locking latch and screw locking								
	gray		CES-STPG-GY	0801715	10	CES-LTPG-GY	0801716	10

Cable sleeves, thermoplastics, special formats

Advantages:

- Low flammability according to UL 94 V0 of thermoplastic sleeves
- Good resistance to acids and lyes

Notes:
The CES cable entry system was developed according to DIN EN 50262 (Cable glands for electrical installations).
The cable sleeves must be mounted in accordance with the mounting instructions provided.



Cable sleeves, small, with several bore holes



Cable sleeves, small, for AS interface cables



Technical data	
Material	SEBS
Degree of protection	IP44
Inflammability class according to UL 94	V0
Temperature range	-40 ... 80 [°C]

Technical data	
Material	SEBS
Degree of protection	IP54
Inflammability class according to UL 94	V0
Temperature range	-40 ... 80

Ordering data		
Type	Order No.	Pcs. / Pkt.
Cable sleeves, with 2 bore holes, small, slotted, can be used in sealing frames with locking latch and screw locking, for cable diameter of:		
2x 2 mm ... 3 mm	gray	CES-STPG-GY-2X3 1410424 10
2x 3 mm ... 4 mm	gray	CES-STPG-GY-2X4 1410438 10
2x 4 mm ... 5 mm	gray	CES-STPG-GY-2X5 0801708 10
2x 5 mm ... 6 mm	gray	CES-STPG-GY-2X6 0801709 10
2x 6 mm ... 7 mm	gray	CES-STPG-GY-2X7 1410110 10
2x 7 mm ... 8 mm	gray	CES-STPG-GY-2X8 1410123 10
2x 8 mm ... 9 mm	gray	CES-STPG-GY-2X9 1410440 10
Cable sleeves, with 4 bore holes, small, slotted, can be used in sealing frames with locking latch and screw locking, for cable diameter of:		
4 x 2 mm ... 3 mm	gray	CES-STPG-GY-4X3 0801710 10
4 x 3 mm ... 4 mm	gray	CES-STPG-GY-4X4 0801711 10
4 x 4 mm ... 5 mm	gray	CES-STPG-GY-4X5 1410136 10
4 x 5 mm ... 6 mm	gray	CES-STPG-GY-4X6 1410149 10
Cable sleeve, IP54, slotted, for one AS-Interface cable, cable arrangement:		
L	gray	CES-STPG-GY-1ASI-L 1410068 10
R	gray	CES-STPG-GY-1ASI-R 0801712 10
Cable sleeve, IP54, slotted, for two AS-Interface cables, cable arrangement:		
LL	gray	CES-STPG-GY-2ASI-LL 1410071 10
RR	gray	CES-STPG-GY-2ASI-RR 0801713 10
LR	gray	CES-STPG-GY-2ASI-LR 0801714 10

Ordering data		
Type	Order No.	Pcs. / Pkt.
Cable sleeve, IP54, slotted, for one AS-Interface cable, cable arrangement:		
L	gray	CES-STPG-GY-1ASI-L 1410068 10
R	gray	CES-STPG-GY-1ASI-R 0801712 10
Cable sleeve, IP54, slotted, for two AS-Interface cables, cable arrangement:		
LL	gray	CES-STPG-GY-2ASI-LL 1410071 10
RR	gray	CES-STPG-GY-2ASI-RR 0801713 10
LR	gray	CES-STPG-GY-2ASI-LR 0801714 10

Installation and mounting material

CES cable entry system

Accessories, filler plugs, EMC cable catch rails



Filler plugs with a diameter of
2 mm to 17 mm



EMC cable catch rail for mounting on
CES sealing frames

General data		Technical data			Technical data		
Material		PA			Stainless steel		
Degree of protection		IP54			-		
Inflammability class according to UL 94		-			-		
Temperature range	[°C]	-20 ... 80			-		
Description		Ordering data			Ordering data		
	Color	Type	Order No.	Pcs. / Pkt.	Type	Order No.	Pcs. / Pkt.
Filler plugs , for sealing unused cable sleeves with a diameter of:							
2 mm	black	KDT-ST 2	1410220	25			
3 mm	black	KDT-ST 3	3063921	25			
4 mm	black	KDT-ST 4	3063934	25			
5 mm	black	KDT-ST 5	3063947	25			
6 mm	black	KDT-ST 6	3063950	25			
7 mm	black	KDT-ST 7	3063963	25			
8 mm	black	KDT-ST 8	3063976	25			
9 mm	black	KDT-ST 9	3063989	25			
10 mm	black	KDT-ST 10	3063992	25			
11 mm	black	KDT-ST 11	3064001	25			
12 mm	black	KDT-ST 12	3062016	25			
13 mm	black	KDT-ST 13	3062029	25			
14 mm	black	KDT-ST 14	3062032	25			
15 mm	black	KDT-ST 15	3062045	25			
16 mm	black	KDT-ST 16	3062058	25			
17 mm	black	KDT-ST 17	3062061	25			
EMC cable catch rail , for mounting on the longitudinal side of the CES-B16... CES sealing frame					KEL-EMV 16-4	3063507	5
EMC cable catch rail , for mounting on the longitudinal side of the CES-B24... CES sealing frame					KEL-EMV 24-5	3063510	5
EMC cable catch rail , for mounting on the diagonal side of the CES-B16 ... and CES-24 ... CES sealing frames					KEL-EMV-F	3063523	5

**Dimensional drawings
CES... sealing frames**

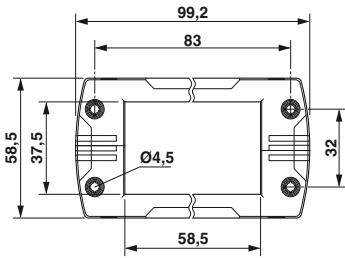

CES-B10-HFFS-PLBK
CES-B10-SFFS-PLBK

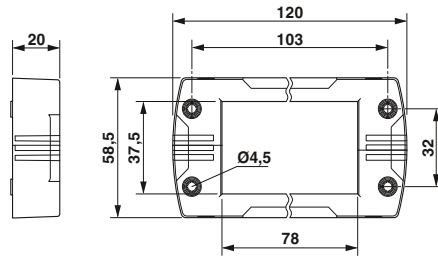

CES-B16-HFFS-PLBK
CES-B16-SFFS-PLBK
CES-B16-8XSRC-BK

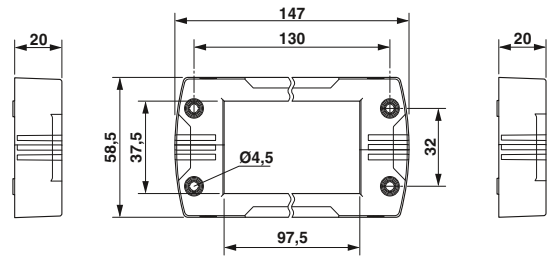

CES-B24-HFFS-PLBK
CES-B24-SFFS-PLBK
CES-B24-10XSRC-BK

**Dimensional drawings
CES... snap-on frames**

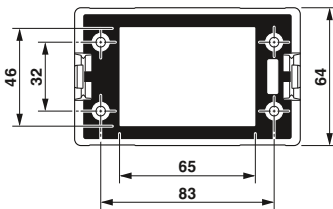
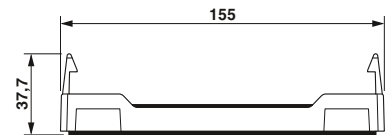
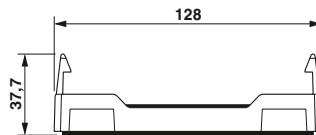

CES-B10-SF-PLBK

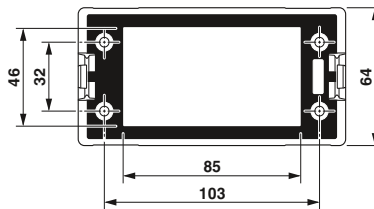

CES-B16-SF-PLBK

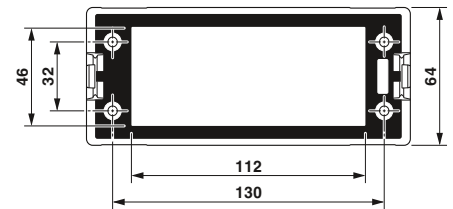

CES-B24-SF-PLBK

Module plates



For accommodating CES B24 sealing frames and CES Multigates cable feed-throughs.

Pre-assembled for time-saving and easy assembly:

- Partition plates
- Control cabinet bottom
- Control cabinet hole matrix
- Rails for the TS system (Rittal)



Module plates

General data

Material	Stainless steel 1.4301/AISI 304
Sealing material	NBR
Degree of protection	IP54
Temperature range	-40 ... 100 [°C]

Technical data

Material	Stainless steel 1.4301/AISI 304
Sealing material	NBR
Degree of protection	IP54
Temperature range	-40 ... 100

Ordering data

Description	Color	Type	Order No.	Pcs. / Pkt.
Module plates, with seal, for CES B24 sealing frames				
3 openings	silver	MD-INB24-3-SZP-S	1415242	1
4 openings	silver	MD-INB24-4-SZP-S	1415243	1
Floor panel, with seal, CES Multigates				
One opening	silver	MD-INC-1-SZP-S	1415245	1
Floor panel, with seal				
No opening	silver	MD-IN-0-SZP-S	1415244	1

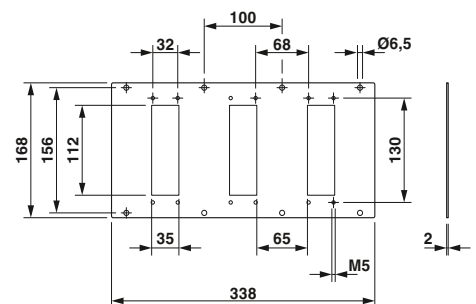

MD-INB24-3-SZP-S

Installation and mounting material

Cable feed-throughs

Cable feed-throughs



The conduits make IP54-rated sealing possible when leading preassembled conductors into the control cabinet.

This is done by pushing the slit sleeves over the conductor, positioning them and placing them in the cable feed-through housing.

Unused feed-through positions are filled with filler plugs.



Conduit/cable feed-through sleeves

ERC

Material data
Material
Inflammability class according to UL 94
Degree of protection
Temperature data
Ambient temperature (operation)

Technical data	
HC-KD/SG-...	HC-KDT... / HC-KDG-B
PC; gray similar to RAL 7044	Thermoplastic rubber
V0	HB
IP54	IP54
-40 °C ... 125 °C	-40 °C ... 125 °C

Description

Conduit, for connector housings:

HC-B16-AMQ (Order No. 1771587)
 HC-B24-AMQ (Order No. 1771927)

Cable feed-through sleeves, for insertion in the conduit, for conductor diameters:

3 mm ... 4 mm
 4 mm ... 5 mm
 5 mm ... 6 mm
 6 mm ... 7 mm
 7 mm ... 8 mm
 8 mm ... 9 mm
 9 mm ... 10 mm

Cable feed-through sleeves, for insertion in the conduit, in addition to the strain relief, a cable binder can be used, for conductor diameters:

10 mm ... 11 mm
 11 mm ... 12 mm
 12 mm ... 13 mm
 13 mm ... 14 mm
 14 mm ... 15 mm
 15 mm ... 16 mm

Filler plug, to close the unused openings of the HC-KD/SG-... conduit

Marker tags, 5-section, unprinted, marking with X-PEN, B-STIFT, plotter or BKMT 20 x 8 label

Lettering field size: 20 x 8 mm

Ordering data

Type	Order No.	Pcs. / Pkt.
HC-KD/SG 16/ 3	1644012	1
HC-KD/SG 24/ 4	1644025	1
HC-KDT 3-4	1644038	10
HC-KDT 4-5	1644041	10
HC-KDT 5-6	1644054	10
HC-KDT 6-7	1644067	10
HC-KDT 7-8	1644070	10
HC-KDT 8-9	1644083	10
HC-KDT 9-10	1644093	10
HC-KDT 10-11	1644106	10
HC-KDT 11-12	1644119	10
HC-KDT 12-13	1644122	10
HC-KDT 13-14	1644135	10
HC-KDT 14-15	1644148	10
HC-KDT 15-16	1644151	10
HC-KDG-B	1644164	10
SS-ZB WH	5031171	50

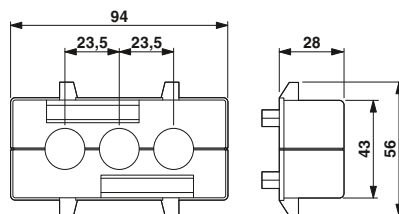

HC-KD/SG 16/ 3

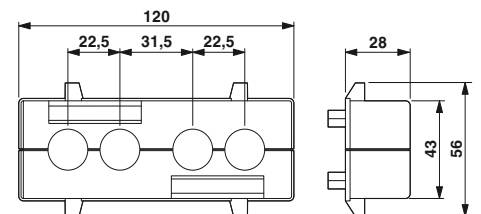

HC-KD/SG 24/ 4

Connector assembly frame



Advantages:

- For standard HEAVYCON contact inserts on NS35/7,5 DIN rail
- Robust cast aluminum housing
- Base frame for pre-assembled contact inserts
- Cable duct function
- Grounding for DIN rail
- Coding function

Notes:
The bridging function of the aluminum design ensures that there is a leading PE.
Stainless steel locking latch, handle: PA-GF
Upon delivery, there is no pre-assembled bracket (HC-CIF..BFWD..). The bracket is assembled after the contact insert.



Base frame/top frame

Material data
Material
Tightening torque
Temperature data
Ambient temperature (operation)

ERIC

Technical data
Cast aluminum, uncoated
2 Nm (locking screw)
-40 °C ... 125 °C

Description	Size
Base frame, with double locking latch	
a = 93.5 mm	For B10
a = 93.5 mm	For B16
a = 120.0 mm	For B24
Base frame, without double locking latch, for screw locking	
a = 120.0 mm	For 2xB6
a = 93.5 mm	For B10
a = 93.5 mm	For B16
a = 120.0 mm	For B24
Top frame, for double locking latch and optionally with locking screws, Allen screw, WAF 3	
a = 150.2 mm	For 2xB6
a = 103.2 mm	For B10
a = 123.7 mm	For B16
a = 150.2 mm	For B24

Ordering data		
Type	Order No.	Pcs. / Pkt.
HC-CIF-B10-BFWD-FH-AL	1404220	1
HC-CIF-B16-BFWD-FH-AL	1404217	1
HC-CIF-B24-BFWD-FH-AL	1404212	1
HC-CIF-2B6-BFFD-FH-AL	1404214	1
HC-CIF-B10-BFFD-FH-AL	1404219	1
HC-CIF-B16-BFFD-FH-AL	1404216	1
HC-CIF-B24-BFFD-FH-AL	1404211	1
HC-CIF-2B6-HFFD-WH-AL	1404215	1
HC-CIF-B10-HFFD-WH-AL	1404221	1
HC-CIF-B16-HFFD-WH-AL	1404218	1
HC-CIF-B24-HFFD-WH-AL	1404213	1

Bit screwdriver, with 1/4" quick-action chuck, suitable for bits according to DIN 3126-C 6.3 and E 6.3/ISO 1173, magnetic
Screw bit, hexagonal, E6.3-1/4" drive, hardened, suitable for holder according to DIN 3126-F 6.3/ISO 1173, size: hex 3 x 50 mm
Size: hex 3 x 50 mm

Accessories		
Type	Order No.	Pcs. / Pkt.
SF-M BH	1212070	1
SF-BIT-HEX 3-50	1212647	5

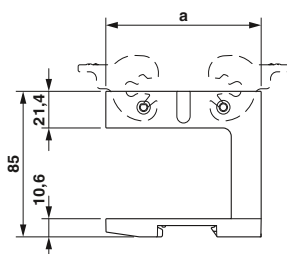

HC-CIF-B24-BFWD-FH-AL

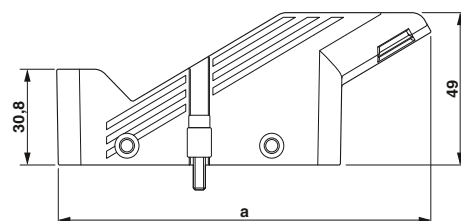
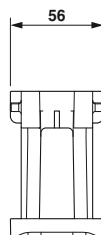

HC-CIF-B24-HFFD-WH-AL

Installation and mounting material

Cable glands

Plastic cable glands, metric, EN 60423

- Material: polyamide 6
- Color: silver gray (RAL 7001)
- Seal: CR
- Ambient temperature: -30°C ... +80°C (+150°C briefly)
- Degree of protection: IP68, 5 bar (30 minutes)
- Strain relief: integrated according to EN 50262

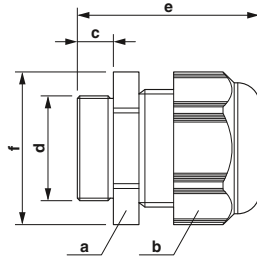

Plastic cable gland



243143 / QCRV2.E320158 / 40024418

Thread type	Color	Clamping area [mm]	Dimensions [mm]						
			a	b	c	d	e	f	g
M12	silver gray	3.00 - 6.50	15.00	15.00	8.00	12.00	32.10	17.10	-
M16	silver gray	5.00 - 10.00	22.00	22.00	10.00	16.00	39.70	25.00	-
M20	silver gray	6.00 - 12.00	24.00	24.00	10.00	20.00	42.30	27.80	-
M25	silver gray	11.00 - 17.00	29.00	29.00	8.00	25.00	42.50	33.50	-
M32	silver gray	15.00 - 21.00	36.00	36.00	10.00	32.00	50.80	40.90	-
M40	silver gray	19.00 - 28.00	46.00	46.00	10.00	40.00	55.10	52.00	-
M50	silver gray	30.00 - 38.00	60.00	60.00	18.00	50.00	71.70	67.70	-
M63	silver gray	34.00 - 44.00	65.00	65.00	18.00	63.00	75.40	72.20	-

Ordering data

Type	Order No.	Pcs. / Pkt.
G-INS-M12-S68N-PNES-GY	1411123	10
G-INS-M16-S68N-PNES-GY	1411124	10
G-INS-M20-S68N-PNES-GY	1411125	5
G-INS-M25-M68N-PNES-GY	1411126	5
G-INS-M32-M68N-PNES-GY	1411127	5
G-INS-M40-M68N-PNES-GY	1411128	5
G-INS-M50-L68L-PNES-GY	1411129	1
G-INS-M63-L68L-PNES-GY	1411130	1

Plastic counter nuts, metric, EN 60423

- Material: polyamide 6
- Color: silver gray (RAL 7001)
- Ambient temperature: -20°C ... +80°C

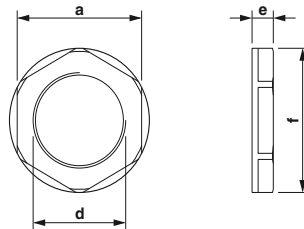

Plastic counter nut

Thread type	Color	Clamping area [mm]	Dimensions [mm]						
			a	b	c	d	e	f	g
M12	silver gray	-	18.00	-	-	12.00	5.00	19.50	-
M16	silver gray	-	22.00	-	-	16.00	5.00	24.20	-
M20	silver gray	-	26.00	-	-	20.00	6.00	28.60	-
M25	silver gray	-	32.00	-	-	25.00	6.00	35.00	-
M32	silver gray	-	41.00	-	-	32.00	7.00	46.10	-
M40	silver gray	-	50.00	-	-	40.00	7.00	55.30	-
M50	silver gray	-	60.00	-	-	50.00	8.00	66.10	-
M63	silver gray	-	75.00	-	-	63.00	8.00	82.50	-

Ordering data

Type	Order No.	Pcs. / Pkt.
A-INL-M12-P-GY	1411205	10
A-INL-M16-P-GY	1411206	10
A-INL-M20-P-GY	1411207	5
A-INL-M25-P-GY	1411208	5
A-INL-M32-P-GY	1411209	5
A-INL-M40-P-GY	1411210	5
A-INL-M50-P-GY	1411211	5
A-INL-M63-P-GY	1411212	5

Plastic cable glands, metric, EN 60423

- Material: polyamide 6
- Color: deep black (RAL 9005)
- Seal: CR
- Ambient temperature: -30°C ... +80°C (+150°C briefly)
- Degree of protection: IP68, 5 bar (30 minutes)
- Strain relief: integrated according to EN 50262

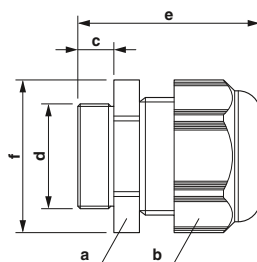

Plastic cable gland



243143 / QCRV.E320158 / 40024418

Ordering data

Thread type	Color	Clamping area [mm]	Dimensions [mm]						
			a	b	c	d	e	f	g
M12	jet black	3.00 - 6.50	15.00	15.00	8.00	12.00	32.10	17.10	-
M16	jet black	5.00 - 10.00	22.00	22.00	10.00	16.00	39.70	25.00	-
M20	jet black	6.00 - 12.00	24.00	24.00	10.00	20.00	42.30	27.80	-
M25	jet black	11.00 - 17.00	29.00	29.00	8.00	25.00	42.50	33.50	-
M32	jet black	15.00 - 21.00	36.00	36.00	10.00	32.00	50.80	40.90	-
M40	jet black	19.00 - 28.00	46.00	46.00	10.00	40.00	55.10	52.00	-
M50	jet black	30.00 - 38.00	60.00	60.00	18.00	50.00	71.70	67.70	-
M63	jet black	34.00 - 44.00	65.00	65.00	18.00	63.00	75.40	72.20	-

Type	Order No.	Pcs. / Pkt.
G-INS-M12-S68N-PNES-BK	1411131	10
G-INS-M16-S68N-PNES-BK	1411132	10
G-INS-M20-S68N-PNES-BK	1411133	5
G-INS-M25-M68N-PNES-BK	1411134	5
G-INS-M32-M68N-PNES-BK	1411136	5
G-INS-M40-M68N-PNES-BK	1411137	5
G-INS-M50-L68L-PNES-BK	1411138	1
G-INS-M63-L68L-PNES-BK	1411139	1

Plastic counter nuts, metric, EN 60423

- Material: polyamide 6
- Color: deep black (RAL 9005)
- Ambient temperature: -20°C ... +80°C

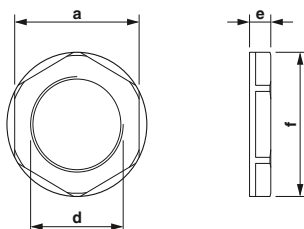

Plastic counter nut

Thread type	Color	Clamping area [mm]	Dimensions [mm]						
			a	b	c	d	e	f	g
M12	jet black	-	18.00	-	-	12.00	5.00	19.50	-
M16	jet black	-	22.00	-	-	16.00	5.00	24.20	-
M20	jet black	-	26.00	-	-	20.00	6.00	28.60	-
M25	jet black	-	32.00	-	-	25.00	6.00	35.00	-
M32	jet black	-	41.00	-	-	32.00	7.00	46.10	-
M40	jet black	-	50.00	-	-	40.00	7.00	55.30	-
M50	jet black	-	60.00	-	-	50.00	8.00	66.10	-
M63	jet black	-	75.00	-	-	63.00	8.00	82.50	-

Ordering data

Type	Order No.	Pcs. / Pkt.
A-INL-M12-P-BK	1411213	10
A-INL-M16-P-BK	1411214	10
A-INL-M20-P-BK	1411215	5
A-INL-M25-P-BK	1411216	5
A-INL-M32-P-BK	1411217	5
A-INL-M40-P-BK	1411218	5
A-INL-M50-P-BK	1411219	5
A-INL-M63-P-BK	1411220	5

Installation and mounting material

Cable glands

Plastic cable glands, Pg, EN 40430

- Material: polyamide 6
- Color: silver gray (RAL 7001)
- Seal: CR
- Ambient temperature:
-30°C ... +80°C (+150°C briefly)
- Degree of protection: IP68, 5 bar
(30 minutes)
- Strain relief: integrated according to
EN 50262

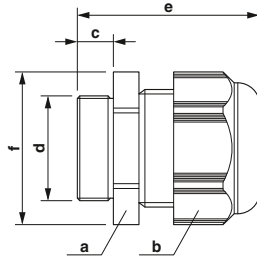

Plastic cable gland

243143 / QCRV2.E320158

Ordering data

Thread type	Color	Clamping area [mm]	Dimensions [mm]							Ordering data		
			a	b	c	d	e	f	g	Type	Order No.	Pcs. / Pkt.
Pg7	silver gray	3.00 - 6.50	15.00	15.00	8.00	12.50	32.70	17.10	-	G-INS-PG7-S68N-PNES-GY	1411140	10
Pg9	silver gray	4.00 - 8.00	19.00	19.00	8.00	15.20	36.20	21.60	-	G-INS-PG9-S68N-PNES-GY	1411141	10
Pg11	silver gray	5.00 - 10.00	22.00	22.00	8.00	18.60	38.10	25.00	-	G-INS-PG11-S68N-PNES-GY	1411142	5
Pg13.5	silver gray	6.00 - 12.00	24.00	24.00	9.00	20.40	40.00	27.80	-	G-INS-PG13,5-S68N-PNES-GY	1411143	5
Pg16	silver gray	10.00 - 14.00	27.00	27.00	10.00	22.50	44.20	30.80	-	G-INS-PG16-S68N-PNES-GY	1411144	5
Pg21	silver gray	13.00 - 18.00	33.00	33.00	11.00	28.30	49.30	37.80	-	G-INS-PG21-M68N-PNES-GY	1411145	5
Pg29	silver gray	18.00 - 25.00	42.00	42.00	11.00	37.00	53.90	48.00	-	G-INS-PG29-M68N-PNES-GY	1411146	5
Pg36	silver gray	22.00 - 32.00	53.00	53.00	13.00	47.00	65.40	60.00	-	G-INS-PG36-L68N-PNES-GY	1411147	5
Pg42	silver gray	30.00 - 38.00	60.00	60.00	13.00	54.00	65.90	67.70	-	G-INS-PG42-L68N-PNES-GY	1411149	1
Pg48	silver gray	34.00 - 44.00	65.00	65.00	14.00	59.30	68.80	72.20	-	G-INS-PG48-L68N-PNES-GY	1411150	1

Plastic counter nuts, Pg, EN 40430

- Material: polyamide 6
- Color: silver gray (RAL 7001)
- Ambient temperature:
-20°C ... +80°C

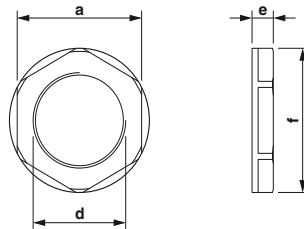

Plastic counter nut

Ordering data

Thread type	Color	Clamping area [mm]	Dimensions [mm]							Ordering data		
			a	b	c	d	e	f	g	Type	Order No.	Pcs. / Pkt.
Pg7	silver gray	-	19.00	-	-	12.50	5.00	21.00	-	A-INL-PG7-P-GY	1411221	10
Pg9	silver gray	-	22.00	-	-	15.20	5.00	24.00	-	A-INL-PG9-P-GY	1411222	10
Pg11	silver gray	-	24.00	-	-	18.60	5.00	26.00	-	A-INL-PG11-P-GY	1411223	5
Pg13.5	silver gray	-	27.00	-	-	20.40	6.00	29.00	-	A-INL-PG13,5-P-GY	1411224	5
Pg16	silver gray	-	30.00	-	-	22.50	6.00	33.00	-	A-INL-PG16-P-GY	1411225	5
Pg21	silver gray	-	36.00	-	-	28.30	7.00	39.00	-	A-INL-PG21-P-GY	1411226	5
Pg29	silver gray	-	46.00	-	-	37.00	7.00	50.00	-	A-INL-PG29-P-GY	1411227	5
Pg36	silver gray	-	60.00	-	-	47.00	8.00	66.00	-	A-INL-PG36-P-GY	1411228	5
Pg42	silver gray	-	65.00	-	-	54.00	8.00	73.00	-	A-INL-PG42-P-GY	1411229	5
Pg48	silver gray	-	70.00	-	-	59.30	8.00	78.00	-	A-INL-PG48-P-GY	1411230	5

**Plastic cable glands,
NPT, ANSI B1.20.1**

- Material: polyamide 6
- Color: silver gray (RAL 7001)
- Seal: CR
- Ambient temperature:
-30°C ... +80°C (+150°C briefly)
- Degree of protection: IP68, 5 bar
(30 minutes)
- Strain relief: integrated according to
EN 50262

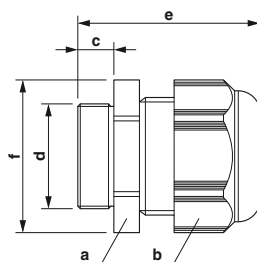

Plastic cable gland



243143 / QCRV.E320158

Ordering data

Thread type	Color	Clamping area [mm]
NPT3/8 inch	silver gray	5.00 - 10.00
1/2 inch NPT	silver gray	10.00 - 14.00
3/4 inch NPT	silver gray	13.00 - 18.00
1 inch NPT	silver gray	18.00 - 25.00

Dimensions [mm]								
a	b	c	d	e	f	g		
22.00	22.00	15.00	16.60	44.50	25.00	-		
27.00	27.00	15.00	20.60	47.10	30.80	-		
33.00	33.00	15.00	25.90	47.50	37.80	-		
42.00	42.00	18.00	32.40	58.50	48.00	-		

Type	Order No.	Pcs. / Pkt.
G-INS-N3/8-S68L-PNES-GY	1411152	10
G-INS-N1/2-S68L-PNES-GY	1411153	10
G-INS-N3/4-M68L-PNES-GY	1411154	5
G-INS-N1-M68L-PNES-GY	1411155	5

**Plastic counter nuts,
NPT, ANSI B1.20.1**

- Material: polyamide 6
- Color: silver gray (RAL 7001)
- Ambient temperature:
-20°C ... +80°C

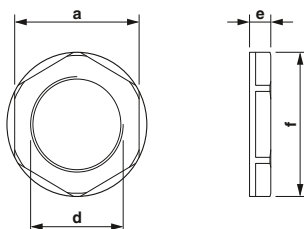

Plastic counter nut

Thread type	Color	Clamping area [mm]
NPT3/8 inch	silver gray	-
1/2 inch NPT	silver gray	-
3/4 inch NPT	silver gray	-
1 inch NPT	silver gray	-

Dimensions [mm]								
a	b	c	d	e	f	g		
22.00	-	-	16.60	5.00	25.00	-		
27.00	-	-	20.60	5.00	30.50	-		
33.00	-	-	25.90	5.00	37.50	-		
47.00	-	-	32.40	6.00	46.50	-		

Ordering data

Type	Order No.	Pcs. / Pkt.
A-INL-NPT3/8-P-GY	1411231	10
A-INL-NPT1/2-P-GY	1411233	10
A-INL-NPT3/4-P-GY	1411234	5
A-INL-NPT1-P-GY	1411235	5

Installation and mounting material

Cable glands

Plastic cable glands, NPT, ANSI B1.20.1

- Material: polyamide 6
- Color: deep black (RAL 9005)
- Seal: CR
- Ambient temperature:
-30°C ... +80°C (+150°C briefly)
- Degree of protection: IP68, 5 bar
(30 minutes)
- Strain relief: integrated according to
EN 50262

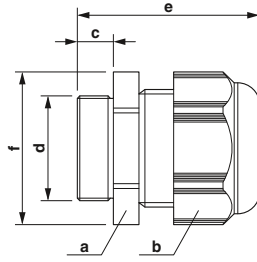

Plastic cable gland



243143 / QCRV.E320158

Thread type	Color	Clamping area [mm]
NPT3/8 inch	jet black	5.00 - 10.00
1/2 inch NPT	jet black	10.00 - 14.00
3/4 inch NPT	jet black	13.00 - 18.00
1 inch NPT	jet black	18.00 - 25.00

Dimensions [mm]								
a	b	c	d	e	f	g	t	
22.00	22.00	15.00	16.60	44.50	-	-		
27.00	27.00	15.00	20.60	47.10	-	-		
33.00	33.00	12.00	25.90	47.50	-	-		
42.00	42.00	18.00	32.40	58.50	-	-		

Ordering data

Type	Order No.	Pcs. / Pkt.
G-INS-N3/8-S68L-PNES-BK	1411156	10
G-INS-N1/2-S68L-PNES-BK	1411157	10
G-INS-N3/4-M68L-PNES-BK	1411158	5
G-INS-N1-M68L-PNES-BK	1411159	5

Plastic counter nuts, NPT, ANSI B1.20.1

- Material: polyamide 6
- Color: deep black (RAL 9005)
- Ambient temperature:
-20°C ... +80°C

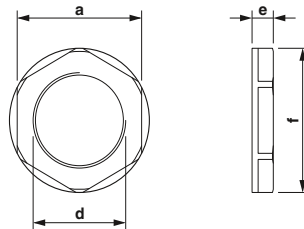

Plastic counter nut

Thread type	Color	Clamping area [mm]
NPT3/8 inch	jet black	-
1/2 inch NPT	jet black	-
3/4 inch NPT	jet black	-
1 inch NPT	jet black	-

Dimensions [mm]								
a	b	c	d	e	f	g	t	
22.00	-	-	16.60	5.00	25.00	-		
27.00	-	-	20.60	5.00	30.50	-		
33.00	-	-	25.90	5.00	37.50	-		
47.00	-	-	32.40	6.00	46.50	-		

Ordering data

Type	Order No.	Pcs. / Pkt.
A-INL-NPT3/8-P-BK	1411236	10
A-INL-NPT1/2-P-BK	1411237	10
A-INL-NPT3/4-P-BK	1411238	5
A-INL-NPT1-P-BK	1411239	5

**Brass cable glands,
metric, EN 60423**

- Material: brass, nickel-plated
- Seal: CR
- Clamping insert: polyamide 6
- O-ring: NBR
- Ambient temperature: -40°C ... +100°C
- Degree of protection: IP68/IP69K
- Strain relief: integrated according to EN 50262

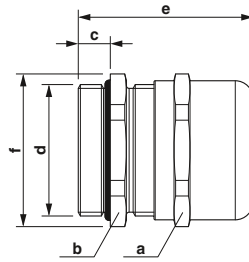

Notes:
For alternative clamping areas, see page 690



Brass cable gland

QCRV.E320158

Thread type	Color	Clamping area [mm]
M12	silver	3.00 - 6.50
M16	silver	5.00 - 10.00
M20	silver	6.00 - 12.00
M25	silver	11.00 - 17.00
M32	silver	15.00 - 21.00
M40	silver	19.00 - 28.00
M50	silver	27.00 - 38.00
M63	silver	34.00 - 44.00

Dimensions [mm]								
a	b	c	d	e	f	g		
14.00	14.00	6.00	12.00	27.80	15.50	-		
20.00	20.00	7.00	16.00	34.50	22.00	-		
22.00	22.00	8.00	20.00	37.50	24.50	-		
27.00	27.00	8.00	25.00	40.00	30.00	-		
34.00	34.00	8.00	32.00	43.00	37.00	-		
43.00	43.00	9.00	40.00	53.70	48.40	-		
58.00	58.00	9.00	50.00	61.00	64.00	-		
64.00	68.00	14.00	63.00	65.20	70.00	-		

Ordering data

Type	Order No.	Pcs. / Pkt.
G-INS-M12-S68N-NNES-S	1411160	10
G-INS-M16-S68N-NNES-S	1411162	10
G-INS-M20-S68N-NNES-S	1411163	5
G-INS-M25-M68N-NNES-S	1411165	5
G-INS-M32-M68N-NNES-S	1411166	5
G-INS-M40-M68N-NNES-S	1411167	5
G-INS-M50-L68N-NNES-S	1411168	1
G-INS-M63-L68N-NNES-S	1411169	1

**Brass counter nuts,
metric, EN 60423**

- Material: brass, nickel-plated
- Ambient temperature: -70°C ... +220°C

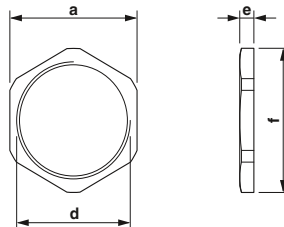

Brass counter nut

Thread type	Color	Clamping area [mm]
M12	silver	-
M16	silver	-
M20	silver	-
M25	silver	-
M32	silver	-
M40	silver	-
M50	silver	-
M63	silver	-

Dimensions [mm]								
a	b	c	d	e	f	g		
15.00	-	-	12.00	2.80	16.50	-		
19.00	-	-	16.00	2.80	21.00	-		
24.00	-	-	20.00	3.00	27.00	-		
30.00	-	-	25.00	3.50	33.50	-		
36.00	-	-	32.00	4.00	40.00	-		
46.00	-	-	40.00	5.00	50.00	-		
57.00	-	-	50.00	5.00	65.00	-		
70.00	-	-	63.00	6.00	75.00	-		

Ordering data

Type	Order No.	Pcs. / Pkt.
A-INL-M12-N-S	1411240	100
A-INL-M16-N-S	1411241	100
A-INL-M20-N-S	1411242	100
A-INL-M25-N-S	1411243	100
A-INL-M32-N-S	1411244	100
A-INL-M40-N-S	1411246	50
A-INL-M50-N-S	1411247	25
A-INL-M63-N-S	1411248	25

Installation and mounting material

Cable glands

Brass cable glands, Pg, EN 40430

- Material: brass, nickel-plated
- Seal: CR
- O-ring: NBR
- Clamping insert: polyamide 6
- Ambient temperature:
-40°C ... +100°C
- Degree of protection: IP68/IP69K
- Strain relief: integrated according to EN 50262

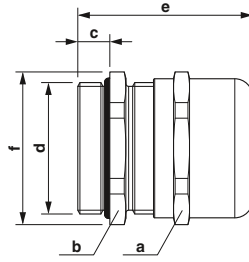

Brass cable gland

QCRV.E320158

Thread type	Color	Clamping area [mm]	Dimensions [mm]						
			a	b	c	d	e	f	g
Pg7	silver	3.00 - 6.50	14.00	14.00	6.00	12.50	27.80	15.50	-
Pg9	silver	4.00 - 8.00	17.00	17.00	6.00	15.20	28.20	18.90	-
Pg11	silver	5.00 - 10.00	20.00	20.00	6.00	18.60	21.00	22.00	-
Pg13.5	silver	6.00 - 12.00	22.00	22.00	6.50	20.40	30.50	24.50	-
Pg16	silver	10.00 - 14.00	24.00	24.00	6.50	22.50	33.90	26.80	-
Pg21	silver	13.00 - 18.00	30.00	30.00	7.20	28.30	38.50	33.00	-
Pg29	silver	18.00 - 25.00	40.00	40.00	8.00	37.00	46.90	44.50	-
Pg36	silver	22.00 - 32.00	50.00	50.00	9.00	47.00	57.20	55.50	-
Pg42	silver	30.00 - 38.00	58.00	58.00	12.00	54.00	60.00	64.00	-
Pg48	silver	34.00 - 44.00	64.00	64.00	14.00	59.30	63.40	70.00	-

Ordering data

Type	Order No.	Pcs. / Pkt.
G-INS-PG7-S68N-NNES-S	1411170	10
G-INS-PG9-S68N-NNES-S	1411171	10
G-INS-PG11-S68N-NNES-S	1411172	5
G-INS-PG13,5-S68N-NNES-S	1411173	5
G-INS-PG16-S68N-NNES-S	1411174	5
G-INS-PG21-M68N-NNES-S	1411175	5
G-INS-PG29-M68N-NNES-S	1411176	5
G-INS-PG36-L68N-NNES-S	1411178	5
G-INS-PG42-L68N-NNES-S	1411179	1
G-INS-PG48-L68N-NNES-S	1411181	1

Brass counter nuts, Pg, EN 40430

- Material: brass, nickel-plated
- Ambient temperature:
-70°C ... +220°C

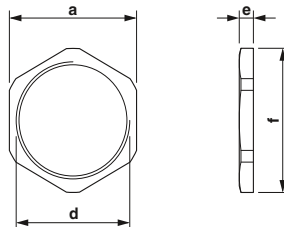

Brass counter nut

Thread type	Color	Clamping area [mm]	Dimensions [mm]						
			a	b	c	d	e	f	g
Pg7	silver	-	15.00	-	-	12.50	2.80	16.50	-
Pg9	silver	-	18.00	-	-	15.20	2.80	20.00	-
Pg11	silver	-	21.00	-	-	18.60	3.00	24.00	-
Pg13.5	silver	-	23.00	-	-	20.40	3.00	26.00	-
Pg16	silver	-	26.00	-	-	22.50	3.00	29.00	-
Pg21	silver	-	32.00	-	-	28.30	3.50	36.00	-
Pg29	silver	-	41.00	-	-	37.00	4.00	45.00	-
Pg36	silver	-	51.00	-	-	47.00	5.00	56.00	-
Pg42	silver	-	60.00	-	-	54.00	5.00	65.00	-
Pg48	silver	-	64.00	-	-	59.30	5.50	69.00	-

Ordering data

Type	Order No.	Pcs. / Pkt.
A-INL-PG7-N-S	1411255	100
A-INL-PG9-N-S	1411256	100
A-INL-PG11-N-S	1411257	100
A-INL-PG13,5-N-S	1411259	100
A-INL-PG16-N-S	1411260	100
A-INL-PG21-N-S	1411262	100
A-INL-PG29-N-S	1411263	50
A-INL-PG36-N-S	1411264	50
A-INL-PG42-N-S	1411265	25
A-INL-PG48-N-S	1411266	25

**Brass cable glands,
NPT, ANSI B1.20.1**

- Material: brass, nickel-plated
- Seal: CR
- O-ring: NBR
- Clamping insert: polyamide 6
- Ambient temperature: -40°C ... +100°C
- Degree of protection: IP68, 5 bar (30 minutes)
- Strain relief: integrated according to EN 50262

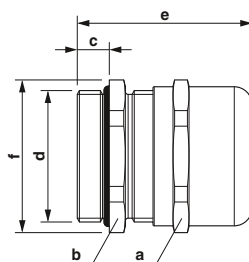

Brass cable gland

UL
QCRV2.E320158

Ordering data

Thread type	Color	Clamping area [mm]	Dimensions [mm]						
			a	b	c	d	e	f	g
NPT3/8 inch	silver	5.00 - 10.00	17.00	19.00	11.50	16.00	34.50	22.00	-
1/2 inch NPT	silver	10.00 - 14.00	22.00	22.00	13.00	21.00	39.00	29.70	-
3/4 inch NPT	silver	13.00 - 18.00	30.00	30.00	13.00	29.00	48.50	33.00	-
1 inch NPT	silver	18.00 - 25.00	40.00	43.00	13.00	32.00	56.00	44.50	-

Type	Order No.	Pcs. / Pkt.
G-INS-NPT3/8-S68L-NNES-S	1411182	10
G-INS-NPT1/2-S68L-NNES-S	1411183	10
G-INS-NPT3/4-M68L-NNES-S	1411184	5
G-INS-NPT1-M68L-NNES-S	1411185	5

**Brass counter nuts
NPT, ANSI B1.20.1**

- Material: brass, nickel-plated
- Ambient temperature: -70°C ... +220°C

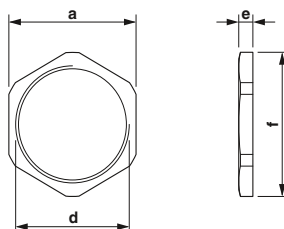

Brass counter nut

Thread type	Color	Clamping area [mm]	Dimensions [mm]						
			a	b	c	d	e	f	g
NPT3/8 inch	silver	-	21.00	-	-	16.60	4.00	24.00	-
1/2 inch NPT	silver	-	26.00	-	-	20.60	5.50	29.00	-
3/4 inch NPT	silver	-	32.00	-	-	25.90	5.50	36.00	-
1 inch NPT	silver	-	41.00	-	-	32.40	7.00	45.00	-

Ordering data

Type	Order No.	Pcs. / Pkt.
A-INL-NPT3/8-N-S	1416009	10
A-INL-NPT1/2-N-S	1416010	10
A-INL-NPT3/4-N-S	1416011	5
A-INL-NPT1-N-S	1416012	5

Installation and mounting material

Cable glands

Brass EMC cable glands, metric, EN 60423

- Material: brass, nickel-plated
- Seal: CR/NBR
- O-ring: NBR
- Clamping insert: polyamide 6
- Contact spring: stainless steel
- Ambient temperature: -20°C ... +100°C
- Degree of protection: IP68, 5 bar (30 minutes)
- Strain relief: integrated according to EN 50262

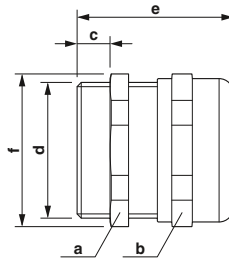

Brass cable gland



QCRV.E140310 / QCRV2.E140310

Thread type	Color	Clamping area [mm]	Dimensions [mm]						
			a	b	c	d	e	f	g
M12	silver	3.00 - 6.50	14.00	14.00	6.00	12.00	28.00	15.50	-
M16	silver	5.00 - 9.00	17.00	17.00	5.00	16.00	30.00	19.00	-
M20	silver	9.00 - 13.00	22.00	22.00	6.00	20.00	33.50	24.00	-
M25	silver	11.00 - 16.00	27.00	27.00	7.00	25.00	36.50	30.00	-
M32	silver	14.00 - 21.00	34.00	34.00	8.00	32.00	38.00	36.00	-
M40	silver	19.00 - 27.00	43.00	43.00	8.00	40.00	41.00	46.00	-
M50	silver	24.00 - 35.00	55.00	55.00	9.00	50.00	49.50	60.00	-
M63	silver	32.00 - 42.00	65.00	65.00	10.00	63.00	52.50	70.00	-

Ordering data

Type	Order No.	Pcs. / Pkt.
G-INSEC-M12-S68N-NCRS-S	1411187	10
G-INSEC-M16-S68N-NCRS-S	1411188	10
G-INSEC-M20-S68N-NCRS-S	1411189	5
G-INSEC-M25-S68N-NCRS-S	1411190	5
G-INSEC-M32-M68N-NCRS-S	1411191	5
G-INSEC-M40-M68N-NCRS-S	1411192	5
G-INSEC-M50-L68N-NCRS-S	1411193	1
G-INSEC-M63-L68N-NCRS-S	1411194	1

Brass counter nuts, metric, EN 60423, ribbed

- Material: brass, nickel-plated
- Ambient temperature: -70°C ... +220°C
- Version: ribbed

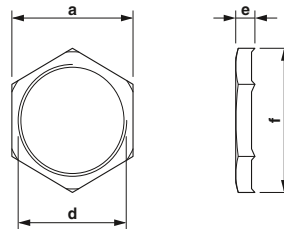

Brass counter nut

Thread type	Color	Clamping area [mm]	Dimensions [mm]						
			a	b	c	d	e	f	g
M12	silver	-	15.00	-	-	12.00	4.70	16.50	-
M16	silver	-	19.00	-	-	16.00	4.70	21.00	-
M20	silver	-	24.00	-	-	20.00	4.70	27.00	-
M25	silver	-	30.00	-	-	25.00	5.20	33.50	-
M32	silver	-	36.00	-	-	32.00	5.70	40.00	-
M40	silver	-	46.00	-	-	40.00	6.50	50.00	-
M50	silver	-	60.00	-	-	50.00	6.50	65.00	-
M63	silver	-	70.00	-	-	63.00	7.00	75.00	-

Ordering data

Type	Order No.	Pcs. / Pkt.
A-INLE-M12-N-S	1411267	100
A-INLE-M16-N-S	1411268	100
A-INLE-M20-N-S	1411269	100
A-INLE-M25-N-S	1411270	50
A-INLE-M32-N-S	1411271	50
A-INLE-M40-N-S	1411272	50
A-INLE-M50-N-S	1411273	10
A-INLE-M63-N-S	1411274	10

**Brass EMC cable glands,
Pg, EN 40430**

- Material: brass, nickel-plated
- Seal: CR
- O-ring: NBR
- Clamping insert: polyamide 6
- Contact spring: copper beryllium
- Ambient temperature:
-40°C ... +100°C
- Degree of protection: IP68, 5 bar
(30 minutes)
- Strain relief: integrated according to
EN 50262

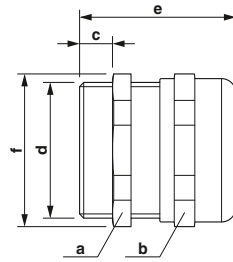

Brass cable gland

UL
QCRV2.E320158

Thread type	Color	Clamping area [mm]	Dimensions [mm]						
			a	b	c	d	e	f	g
Pg7	silver	3.00 - 6.50	14.00	14.00	6.00	12.50	27.00	15.50	-
Pg9	silver	4.00 - 8.00	17.00	17.00	6.00	15.20	29.00	18.90	-
Pg11	silver	5.00 - 10.00	20.00	20.00	6.00	18.60	30.00	22.00	-
Pg13.5	silver	6.00 - 12.00	22.00	22.00	6.50	20.40	30.00	24.50	-
Pg16	silver	10.00 - 14.00	24.00	24.00	6.50	22.50	33.90	26.80	-
Pg21	silver	13.00 - 18.00	30.00	30.00	7.20	28.30	38.50	33.00	-
Pg29	silver	18.00 - 25.00	40.00	40.00	8.00	37.00	47.00	44.50	-
Pg36	silver	22.00 - 32.00	50.00	50.00	9.00	47.00	57.00	55.50	-
Pg42	silver	30.00 - 38.00	58.00	58.00	12.00	54.00	60.00	64.00	-
Pg48	silver	34.00 - 44.00	64.00	64.00	14.00	59.30	65.00	70.00	-

Ordering data		
Type	Order No.	Pcs. / Pkt.
G-INSEC-PG7-S68N-NNES-S	1411195	10
G-INSEC-PG9-S68N-NNES-S	1411196	10
G-INSEC-PG11-S68N-NNES-S	1411197	5
G-INSEC-PG13,5-S68N-NNES-S	1411198	5
G-INSEC-PG16-S68N-NNES-S	1411199	5
G-INSEC-PG21-M68N-NNES-S	1411200	5
G-INSEC-PG29-M68N-NNES-S	1411201	5
G-INSEC-PG36-L68N-NNES-S	1411202	5
G-INSEC-PG42-L68N-NNES-S	1411203	1
G-INSEC-PG48-L68N-NNES-S	1411204	1

**Brass counter nuts,
Pg, EN 40430, ribbed**

- Material: brass, nickel-plated
- Ambient temperature:
-70°C ... +220°C
- Version: ribbed

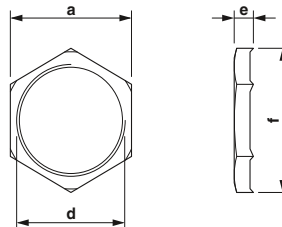

Brass counter nut

Thread type	Color	Clamping area [mm]	Dimensions [mm]						
			a	b	c	d	e	f	g
Pg7	silver	-	15.00	-	-	12.50	4.70	16.50	-
Pg9	silver	-	18.00	-	-	15.20	4.70	20.00	-
Pg11	silver	-	21.00	-	-	18.60	4.70	24.00	-
Pg13.5	silver	-	23.00	-	-	20.40	4.70	26.00	-
Pg16	silver	-	26.00	-	-	22.50	4.70	29.00	-
Pg21	silver	-	32.00	-	-	28.30	5.20	36.00	-
Pg29	silver	-	41.00	-	-	37.00	5.70	45.00	-
Pg36	silver	-	51.00	-	-	47.00	6.50	56.00	-

Ordering data		
Type	Order No.	Pcs. / Pkt.
A-INLE-PG7-N-S	1411275	100
A-INLE-PG9-N-S	1411276	100
A-INLE-PG11-N-S	1411277	100
A-INLE-PG13,5-N-S	1411278	100
A-INLE-PG16-N-S	1411279	100
A-INLE-PG21-N-S	1411280	50
A-INLE-PG29-N-S	1411281	50
A-INLE-PG36-N-S	1411282	50

Installation and mounting material

Cable glands

Brass cable glands, metric, EN 60423

- Material: brass, nickel-plated
- Seal: CR
- O-ring: NBR
- Ambient temperature: -20°C ... +100°C
- Degree of protection: IP68, 5 bar (30 minutes)

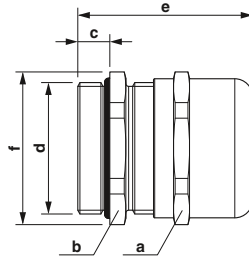

Brass cable gland

Notes:
For counter nuts, see page 685

ERC
7500651.22.01.00246

Thread type	Color	Clamping area [mm]	Dimensions [mm]						
			a	b	c	d	e	f	g
M20	silver	11.00 - 16.00	27.00	27.00	6.00	20.00	26.00	30.00	-
M25	silver	14.00 - 21.00	34.00	34.00	7.50	25.00	31.00	36.00	-
M32	silver	19.00 - 27.00	43.00	43.00	8.00	32.00	32.00	46.00	-
M40	silver	27.00 - 34.00	50.00	50.00	8.00	40.00	35.00	58.00	-

Ordering data

Type	Order No.	Pcs. / Pkt.
HC-M-KV-M20(11-16)	1645998	25
HC-M-KV-M25(14-21)	1646007	25
HC-M-KV-M32(19-27)	1646010	10
HC-M-KV-M40(27-34)	1607729	10

Membrane screw connection

new

- Material: polypropylene
- For panel thickness of 0.8 mm ... 3.5 mm
- UV-resistant
- Ambient temperature: -40°C ... +65°C
- Degree of protection: IP66/IP67

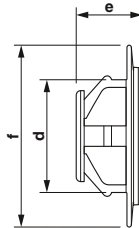

Membrane screw connection

Thread type	Color	Clamping area [mm]	Dimensions [mm]						
			a	b	c	d	e	f	g
M16	light gray	4.00 - 10.00	-	-	8.00	16.00	15.00	32.00	-
M20	light gray	6.00 - 13.00	-	-	8.00	20.00	15.00	34.00	-
M25	light gray	9.00 - 17.00	-	-	8.00	25.00	15.00	40.00	-

Ordering data

Type	Order No.	Pcs. / Pkt.
MG-INC-M16-S67L-PTES-LG	1415186	20
MG-INC-M20-S67L-PTES-LG	1415187	20
MG-INC-M25-M67L-PTES-LG	1415188	20

new

Plastic cable glands with bend protection, metric, EN 60423

- Material: polyamide
- Seal: EPDM
- Glow-wire test: 750°C
- Ambient temperature: -40°C ... +100°C (+120°C briefly)
- Degree of protection: IP68, 5 bar (30 minutes)

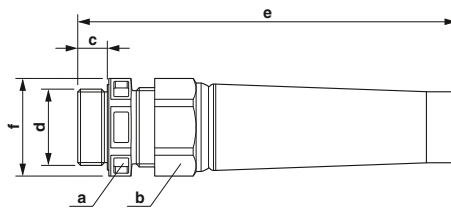

Notes:
For counter nuts, see page 680



Plastic cable gland with bend protection

UL E179850

Ordering data

Thread type	Color	Clamping area [mm]	Dimensions [mm]						
			a	b	c	d	e	f	g
M12	light gray	3.00 - 7.00	16.00	16.00	9.00	12.00	72.00	18.00	-
M16	light gray	4.50 - 10.00	20.00	20.00	9.00	16.00	82.00	22.00	-
M20	light gray	6.00 - 13.00	24.00	24.00	12.00	20.00	103.00	27.00	-
M25	light gray	9.00 - 17.00	29.00	29.00	12.00	25.00	113.00	32.00	-
M32	light gray	13.00 - 21.00	36.00	36.00	12.00	32.00	138.00	40.00	-
M12	black	3.00 - 7.00	16.00	16.00	9.00	12.00	72.00	18.00	-
M16	black	4.50 - 10.00	20.00	20.00	9.00	16.00	82.00	22.00	-
M20	black	6.00 - 13.00	24.00	24.00	12.00	20.00	103.00	27.00	-
M25	black	9.00 - 17.00	29.00	29.00	12.00	25.00	113.00	32.00	-
M32	black	13.00 - 21.00	36.00	36.00	12.00	32.00	138.00	40.00	-

Type	Order No.	Pcs. / Pkt.
G-INB-M12-S68N-PEPDS-LG	1415171	10
G-INB-M16-S68N-PEPDS-LG	1415172	10
G-INB-M20-S68N-PEPDS-LG	1415174	10
G-INB-M25-M68N-PEPDS-LG	1415175	10
G-INB-M32-M68N-PEPDS-LG	1415176	5
G-INB-M12-S68N-PEPDS-BK	1415177	10
G-INB-M16-S68N-PEPDS-BK	1415178	10
G-INB-M20-S68N-PEPDS-BK	1415179	10
G-INB-M25-M68N-PEPDS-BK	1415180	10
G-INB-M32-M68N-PEPDS-BK	1415181	5

Brass cable glands with bend protection, metric, EN 60423

- Material: brass, nickel-plated
- Seal: EPDM
- O-ring: EPDM
- Ambient temperature: -40°C ... +100°C (+120°C briefly)
- Degree of protection: IP68, 5 bar (30 minutes)

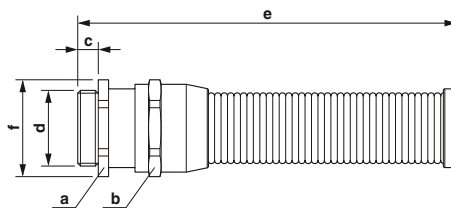

Notes:
For counter nuts, see page 685



Brass cable gland with bend protection

UL E179850

Ordering data

Thread type	Color	Clamping area [mm]	Dimensions [mm]						
			a	b	c	d	e	f	g
M20	silver	6.00 - 13.00	24.00	24.00	6.00	20.00	96.00	27.00	-
M25	silver	9.00 - 17.00	29.00	29.00	7.00	25.00	120.00	32.00	-
M32	silver	13.00 - 21.00	36.00	36.00	8.00	32.00	146.00	40.00	-
M40	silver	16.00 - 28.00	46.00	46.00	8.00	40.00	184.00	51.00	-

Type	Order No.	Pcs. / Pkt.
G-INB-M20-S68N-NEPDS-S	1415182	5
G-INB-M25-M68N-NEPDS-S	1415183	5
G-INB-M32-M68N-NEPDS-S	1415184	1
G-INB-M40-M68N-NEPDS-S	1415185	1

Installation and mounting material

Cable glands

Plastic cable glands with strain relief, metric, EN 60423

- Material: polyamide
- Seal: EPDM
- Glow-wire test: 750°C
- Ambient temperature: -40°C ... +100°C (+120°C briefly)
- Degree of protection: IP68, 5 bar (30 minutes)

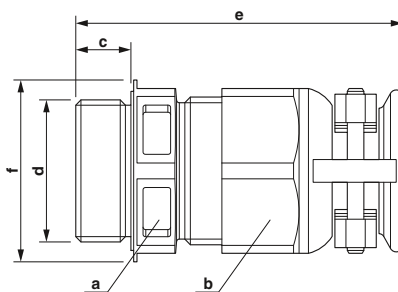

Notes:
For counter nuts, see page 681



new

Plastic cable gland with strain relief

UL E179850

Ordering data

Thread type	Color	Clamping area [mm]
M20	black	6.00 - 13.00
M25	black	9.00 - 17.00
M32	black	13.00 - 21.00

Dimensions [mm]								
a	b	c	d	e	f	g		
24.00	24.00	10.00	20.00	49.00	26.50	-		
29.00	29.00	10.00	25.00	51.00	32.00	-		
36.00	36.00	12.00	32.00	57.00	40.00	-		

Type	Order No.	Pcs. / Pkt.
G-INTRO-M20-S68N-PEPDS-BK	1415189	10
G-INTRO-M25-M68N-PEPDS-BK	1415190	10
G-INTRO-M32-M68N-PEPDS-BK	1415191	5

Brass cable glands with strain relief, metric, EN 60423

- Material: brass, nickel-plated
- Seal: EPDM
- O-ring: EPDM
- Ambient temperature: -40°C ... +100°C (+120°C briefly)
- Degree of protection: IP68, 5 bar (30 minutes)

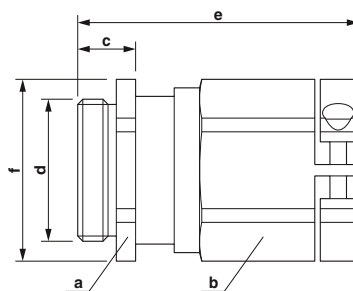

Notes:
For counter nuts, see page 685



new

Brass cable gland with strain relief

UL E179850

Ordering data

Thread type	Color	Clamping area [mm]
M20	silver	6.00 - 13.00
M25	silver	9.00 - 17.00
M32	silver	13.00 - 21.00
M40	silver	16.00 - 28.00

Dimensions [mm]								
a	b	c	d	e	f	g		
24.00	24.00	6.00	20.00	37.00	27.00	-		
29.00	29.00	7.00	25.00	42.00	32.00	-		
36.00	36.00	8.00	32.00	45.00	40.00	-		
46.00	46.00	8.00	40.00	54.00	51.00	-		

Type	Order No.	Pcs. / Pkt.
G-INESR-M20-S68N-NEPDS-S	1415192	5
G-INESR-M25-M68N-NEPDS-S	1415193	5
G-INESR-M32-M68N-NEPDS-S	1415194	1
G-INESR-M40-M68N-NEPDS-S	1415195	1

Brass cable glands with bend protection and strain relief, metric, EN 60423

- Material: brass, nickel-plated
- Seal: NBR
- O-ring: NBR
- Ambient temperature: -30°C ... +80°C
- Degree of protection: IP65

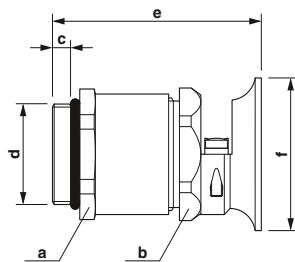

Notes:
For counter nuts, see page 685



Brass cable gland with cable bend protection and strain relief

ERIC
7500651.22.01.00246

Thread type	Color	Clamping area [mm]
M20	silver	7.50 - 15.00
M25	silver	10.00 - 19.00
M32	silver	18.00 - 27.00

Dimensions [mm]							
a	b	c	d	e	f	g	
24.00	24.00	6.00	20.00	40.00	32.00	-	
30.00	30.00	7.00	25.00	44.00	38.00	-	
41.00	40.00	8.00	32.00	51.00	50.00	-	

Ordering data		
Type	Order No.	Pcs. / Pkt.
HC-M-KV-T-M20	1646188	10
HC-M-KV-T-M25	1646191	10
HC-M-KV-T-M32	1646201	10

Brass cable glands with strain relief clamp, metric, EN 60423

- Material: brass, nickel-plated
- Seal: NBR
- O-ring: NBR
- Ambient temperature: -30°C ... +80°C
- Degree of protection: IP65

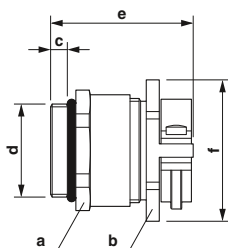

Notes:
For counter nuts, see page 685



Brass cable gland with strain relief clamp

ERIC
7500651.22.01.00246

Thread type	Color	Clamping area [mm]
M20	silver	7.50 - 15.00
M25	silver	10.00 - 19.00
M32	silver	18.00 - 27.00
M40	silver	24.00 - 33.00

Dimensions [mm]							
a	b	c	d	e	f	g	
27.00	24.00	6.00	20.00	35.00	30.00	-	
34.00	30.00	7.00	25.00	39.00	38.00	-	
42.00	40.00	8.00	32.00	43.00	47.00	-	
52.00	50.00	8.00	40.00	49.00	56.00	-	

Ordering data		
Type	Order No.	Pcs. / Pkt.
HC-M-KV-Z-M20	1646146	10
HC-M-KV-Z-M25	1646159	10
HC-M-KV-Z-M32	1646162	10
HC-M-KV-Z-M40	1646175	10

Installation and mounting material

Cable glands

Pressure compensation elements

new

For avoiding condensation

- Material: polyamide, stainless steel
- Membrane: acrylic copolymer
- O-ring: NBR
- Ambient temperature: -40°C ... +105°C
- Degree of protection: IP66/IP67/IP69K

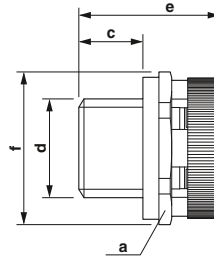

Pressure compensation elements

Thread type	Color	Clamping area [mm]	Dimensions [mm]						
			a	b	c	d	e	f	g
M12	light gray	-	17.00	-	10.00	12.00	17.50	18.50	-
M12	black	-	17.00	-	10.00	12.00	17.50	18.50	-
M12	silver	-	17.00	-	10.00	12.00	21.00	18.50	-

Ordering data		
Type	Order No.	Pcs. / Pkt.
A-INB-M12-69KN-P-LG	1415222	5
A-INB-M12-69KN-P-BK	1415223	5
A-INB-M12-69KN-S-S	1415224	5

Metal NPT adapter, metric external thread, NPT internal thread

- Material: brass, nickel-plated
- O-ring: NBR
- Ambient temperature: -20°C ... +80°C

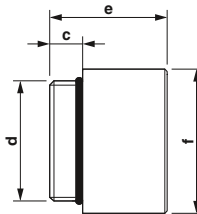

NPT adapter

ERIC
7500651.22.01.00246

Thread type	Color	Clamping area [mm]	Dimensions [mm]						
			a	b	c	d	e	f	g
M20 / 1/2-inch NPT	silver	-	-	-	6.50	20.00	25.00	24.00	-
M25 / 3/4 inch NPT	silver	-	-	-	7.00	25.00	28.00	30.00	-
M32 / 1/1 inch NPT	silver	-	-	-	8.00	32.00	33.00	38.00	-
M40 / 1 1/4 in. NPT	silver	-	-	-	8.00	40.00	26.00	46.00	-

Ordering data		
Type	Order No.	Pcs. / Pkt.
HC-NPT-1/2-M20	1686847	25
HC-NPT-3/4-M25	1686850	25
HC-NPT-1/1-M32	1686863	10
HC-NPT-1 1/4-M40	1687587	10

Plastic screw plugs

- Material: polyamide, fiberglass reinforced
- O-ring: EPDM
- Ambient temperature:
-40°C ... +100°C (+150°C briefly)
- Degree of protection: IP68

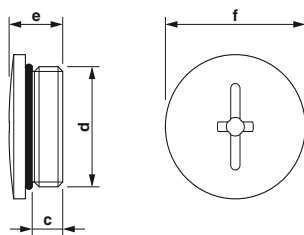

Plastic screw plug

Thread type	Color	Clamping area [mm]	Dimensions [mm]						
			a	b	c	d	e	f	g
M20	black	-	-	-	6.00	20.00	9.50	24.00	-
M25	black	-	-	-	8.00	25.00	11.50	30.00	-
M32	black	-	-	-	8.00	32.00	12.00	37.00	-
M40	black	-	-	-	8.00	40.00	13.00	46.00	-
Pg16	black	-	-	-	6.00	22.50	9.50	27.00	-
Pg21	black	-	-	-	8.00	28.30	11.00	33.00	-
Pg29	black	-	-	-	8.00	37.00	12.00	44.00	-

Ordering data		
Type	Order No.	Pcs. / Pkt.
A-INSP-M20-65N-P-BK	1415206	10
A-INSP-M25-65N-P-BK	1415207	10
A-INSP-M32-65N-P-BK	1415208	10
A-INSP-M40-65N-P-BK	1415210	5
A-INSP-PG16-65N-P-BK	1415213	10
A-INSP-PG21-65N-P-BK	1415214	10
A-INSP-PG29-65N-P-BK	1415215	10

Metal screw plugs

- Material: brass, nickel-plated
- O-ring: NBR
- Ambient temperature:
-20°C ... +80°C
- Degree of protection: IP68

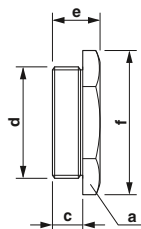

Metal screw plug

ERIC
7500651.22.01.00246

Thread type	Color	Clamping area [mm]	Dimensions [mm]						
			a	b	c	d	e	f	g
M16	silver	-	18.00	-	5.00	16.00	8.00	20.00	-
M20	silver	-	22.00	-	6.00	20.00	9.00	24.00	-
M25	silver	-	28.00	-	6.50	25.00	10.00	31.50	-
M32	silver	-	35.00	-	7.00	32.00	10.50	39.00	-
M40	silver	-	44.00	-	8.00	40.00	12.00	50.00	-
Pg11	silver	-	-	-	6.00	19.00	9.00	20.00	-
Pg13.5	silver	-	-	-	6.50	21.00	9.50	22.00	-
Pg16	silver	-	-	-	6.50	23.00	9.50	24.00	-
Pg21	silver	-	-	-	7.00	29.00	11.00	30.00	-
Pg29	silver	-	-	-	8.00	37.50	12.00	39.00	-
Pg36	silver	-	-	-	9.00	47.50	15.00	50.00	-

Ordering data		
Type	Order No.	Pcs. / Pkt.
HC-M-BS-M16	1646227	10
HC-M-BS-M20	1645846	10
HC-M-BS-M25	1645859	10
HC-M-BS-M32	1645862	10
HC-M-BS-M40	1645875	10
HC-BS-PG11	1674493	10
HC-BS-PG13	1674503	10
HC-BS-PG16	1674516	10
HC-BS-PG21	1674529	10
HC-BS-PG29	1674532	10
HC-BS-PG36	1674545	10

Installation and mounting material

Cable glands

Metal extensions

- Material: brass, nickel-plated
- O-ring: NBR
- Ambient temperature:
-20°C ... +80°C

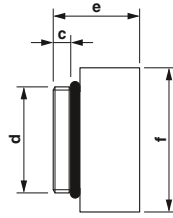

Metal extension adapter

ERC
7500651.22.01.00246

Thread type	Color	Clamping area [mm]	Dimensions [mm]						
			a	b	c	d	e	f	g
M16 / M20	silver	-	-	-	6.00	16.00	17.50	22.00	-
M20 / M25	silver	-	-	-	6.50	20.00	19.00	27.00	-
M25 / M32	silver	-	-	-	6.50	25.00	21.00	34.00	-
M32 / M40	silver	-	-	-	7.00	32.00	23.00	42.00	-
Pg13.5 / Pg16	silver	-	-	-	6.50	21.00	19.00	24.00	-
Pg16 / Pg21	silver	-	-	-	6.50	23.00	21.00	30.00	-
Pg21 / Pg29	silver	-	-	-	7.00	29.00	23.00	39.00	-

Ordering data

Type	Order No.	Pcs. / Pkt.
ENLAR-M-KV-M16/M20	1647653	10
ENLAR-M-KV-M20/M25	1647666	10
ENLAR-M-KV-M25/M32	1647679	10
ENLAR-M-KV-M32/M40	1647682	10
A-INE-PG13/16-N-NS-S	1415219	10
A-INE-PG16/21-N-NS-S	1415220	10
A-INE-PG21/29-N-NS-S	1415221	10

Metal reducing adapter

- Material: brass, nickel-plated
- O-ring: NBR
- Ambient temperature:
-20°C ... +80°C

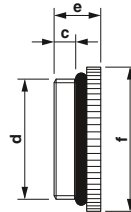

Metal reducing adapter

Thread type	Color	Clamping area [mm]	Dimensions [mm]						
			a	b	c	d	e	f	g
M20 / M16	silver	-	-	-	6.50	20.00	9.00	24.00	-
M25 / M20	silver	-	-	-	7.00	25.00	10.00	30.00	-
M32 / M25	silver	-	-	-	8.00	32.00	11.50	37.00	-
M40 / M32	silver	-	-	-	8.00	40.00	11.50	43.00	-
Pg29 / Pg21	silver	-	-	-	8.00	37.50	11.50	44.00	-
Pg21 / Pg16	silver	-	-	-	7.00	29.00	10.00	33.50	-
Pg16 / Pg13,5	silver	-	-	-	6.50	23.00	9.50	27.00	-

Ordering data

Type	Order No.	Pcs. / Pkt.
REDUC-M-KV-M20/M16	1647611	10
REDUC-M-KV-M25/M20	1647624	10
REDUC-M-KV-M32/M25	1647637	10
REDUC-M-KV-M40/M32	1647640	10
A-INR-PG16/13-N-NS-S	1415216	10
A-INR-PG21/16-N-NS-S	1415217	10
A-INR-PG29/21-N-NS-S	1415218	10

Plastic cable glands, metric, Ex protection

- Halogen-free
- Vibration-proof plastic cable gland with protection against over-tightening of the cap nut
- Glow-wire test: 750°C
- Degree of protection: IP66/IP68, 5 bar (30 minutes)

Marking:

- II 2 G Ex e IIC Gb
- II 2 D Ex IIIC Db IP68

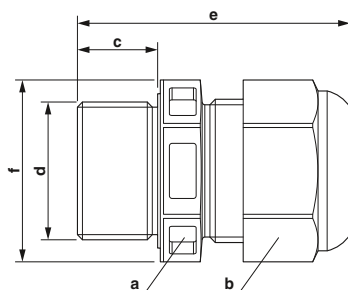

Notes:
For counter nuts, see page 681



new

Plastic cable gland

Ex: PTB 13 ATEX 1015 X / IECEx PTB 13.0034X

General data

Cable gland material
Seal material
O-ring material
Ambient temperature (operation)

Technical data

Polyamide
EPDM
EPDM
-40 °C ... 75 °C

Thread type	Color	Clamping area [mm]	Dimensions [mm]						
			a	b	c	d	e	f	g
M12	black	3.00 - 6.00	16.00	16.00	15.00	12.00	35.00	18.00	-
M16	black	4.50 - 9.00	20.00	20.00	15.00	16.00	37.00	23.00	-
M20	black	7.00 - 13.00	24.00	24.00	15.00	20.00	41.00	28.00	-
M25	black	10.00 - 17.00	29.00	29.00	15.00	25.00	43.00	33.00	-
M32	black	13.00 - 21.00	36.00	36.00	15.00	32.00	45.00	41.00	-
M40	black	17.00 - 28.00	46.00	46.00	18.00	40.00	58.00	51.00	-
M50	black	23.00 - 35.00	55.00	55.00	18.00	50.00	63.00	61.00	-
M63	black	34.00 - 48.00	68.00	68.00	18.00	63.00	67.00	75.00	-

Ordering data

Type	Order No.	Pcs. / Pkt.
G-ESIS-M12-S68L-PEPDS-BK	1415106	10
G-ESIS-M16-S68L-PEPDS-BK	1415107	10
G-ESIS-M20-S68L-PEPDS-BK	1415108	10
G-ESIS-M25-M68L-PEPDS-BK	1415109	10
G-ESIS-M32-M68L-PEPDS-BK	1415110	5
G-ESIS-M40-M68L-PEPDS-BK	1415111	5
G-ESIS-M50-L68L-PEPDS-BK	1415112	1
G-ESIS-M63-L68L-PEPDS-BK	1415113	1

Plastic cable glands, metric, Ex protection

- Halogen-free
- Vibration-proof plastic cable gland with protection against over-tightening of the cap nut
- Glow-wire test: 750°C
- Degree of protection: IP66/IP68, 5 bar (30 minutes)

Marking:

- II 2 G Ex e IIC Gb
- II 2 D Ex IIIC Db IP68

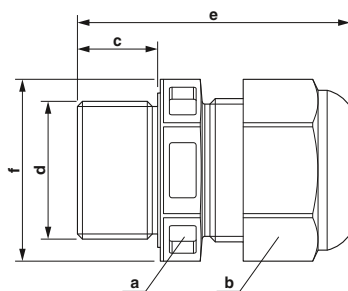

Notes:
For counter nuts, see page 681



new

Plastic cable gland

Ex: PTB 13 ATEX 1015 X / IECEx PTB 13.0034X

General data

Cable gland material
Seal material
O-ring material
Ambient temperature (operation)

Technical data

Polyamide
EPDM
EPDM
-40 °C ... 75 °C

Thread type	Color	Clamping area [mm]	Dimensions [mm]						
			a	b	c	d	e	f	g
M12	black/blue	3.00 - 6.00	16.00	16.00	15.00	12.00	35.00	18.00	-
M16	black/blue	4.50 - 9.00	20.00	20.00	15.00	16.00	37.00	23.00	-
M20	black/blue	7.00 - 13.00	24.00	24.00	15.00	20.00	41.00	28.00	-
M25	black/blue	10.00 - 17.00	29.00	29.00	15.00	25.00	43.00	33.00	-
M32	black/blue	13.00 - 21.00	36.00	36.00	15.00	32.00	45.00	41.00	-
M40	black/blue	17.00 - 28.00	46.00	46.00	18.00	40.00	58.00	51.00	-
M50	black/blue	23.00 - 35.00	55.00	55.00	18.00	50.00	63.00	61.00	-
M63	black/blue	34.00 - 48.00	68.00	68.00	18.00	63.00	67.00	75.00	-

Ordering data

Type	Order No.	Pcs. / Pkt.
G-ESIS-M12-S68L-PEPDS-BL	1415114	10
G-ESIS-M16-S68L-PEPDS-BL	1415116	10
G-ESIS-M20-S68L-PEPDS-BL	1415117	10
G-ESIS-M25-M68L-PEPDS-BL	1415118	10
G-ESIS-M32-M68L-PEPDS-BL	1415119	5
G-ESIS-M40-M68L-PEPDS-BL	1415120	5
G-ESIS-M50-L68L-PEPDS-BL	1415121	1
G-ESIS-M63-L68L-PEPDS-BL	1415122	1

Installation and mounting material

Cable glands

Brass cable glands, metric, Ex protection

- Halogen-free
- Polyamide compression ring
- Degree of protection: IP66/IP68, 5 bar (30 minutes)

Marking:

- II 2 G Ex e IIC Gb
- II 2 D Ex IIIC Db IP68

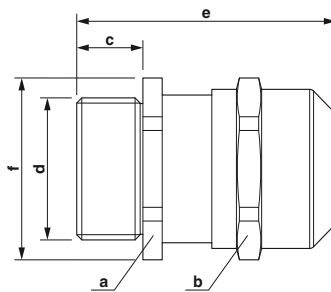

Notes:

For counter nuts, see page 685



new

Brass cable gland



PTB 04 ATEX 1112 X / IECEx PTB 13.0027X

Technical data

Nickel-plated brass
EPDM
EPDM
-40 °C ... 75 °C

General data

Cable gland material
Seal material
O-ring material
Ambient temperature (operation)

Thread type	Color	Clamping area [mm]
M12	silver	4.00 - 7.00
M16	silver	5.00 - 10.00
M20	silver	6.00 - 13.00
M25	silver	10.00 - 17.00
M32	silver	13.00 - 21.00
M40	silver	16.00 - 28.00
M50	silver	21.00 - 35.00
M63	silver	34.00 - 48.00

Dimensions [mm]							
a	b	c	d	e	f	g	
-	16.00	12.00	12.00	30.00	18.00	-	
-	20.00	12.00	16.00	33.00	22.00	-	
-	24.00	12.00	20.00	35.00	27.00	-	
-	29.00	12.00	25.00	38.00	32.00	-	
-	36.00	15.00	32.00	43.00	40.00	-	
-	46.00	15.00	40.00	51.00	51.00	-	
-	55.00	15.00	50.00	57.00	61.00	-	
-	68.00	15.00	63.00	61.00	75.00	-	

Ordering data

Type	Order No.	Pcs. / Pkt.
G-ESIS-M12-S68N-NEPDS-S	1415123	10
G-ESIS-M16-S68N-NEPDS-S	1415124	10
G-ESIS-M20-S68N-NEPDS-S	1415125	10
G-ESIS-M25-M68N-NEPDS-S	1415126	10
G-ESIS-M32-M68L-NEPDS-S	1415127	5
G-ESIS-M40-M68L-NEPDS-S	1415129	5
G-ESIS-M50-L68L-NEPDS-S	1415146	1
G-ESIS-M63-L68L-NEPDS-S	1415147	1

Brass EMC cable glands, metric, Ex protection

- Halogen-free
- Polyamide compression ring
- Permanent braided shield contact by means of grounding cones in the EMC screw connection
- Degree of protection: IP66/IP68, 5 bar (30 minutes)

Marking:

- II 2 G Ex e IIC Gb
- II 2 D Ex IIIC Db IP68

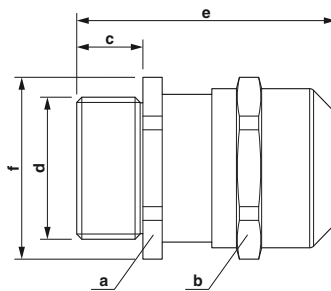

Notes:

For ribbed counter nut, see page 688



new

Brass EMC cable gland



PTB 04 ATEX 1112 X / IECEx PTB 13.0027X

Technical data

Nickel-plated brass
EPDM
EPDM
-40 °C ... 75 °C

General data

Cable gland material
Seal material
O-ring material
Ambient temperature (operation)

Thread type	Color	Clamping area [mm]
M12	silver	4.00 - 7.00
M16	silver	5.00 - 10.00
M20	silver	6.00 - 13.00
M25	silver	10.00 - 17.00
M32	silver	13.00 - 21.00
M40	silver	16.00 - 28.00
M50	silver	21.00 - 35.00
M63	silver	34.00 - 48.00

Dimensions [mm]							
a	b	c	d	e	f	g	
16.00	16.00	12.00	12.00	30.00	18.00	-	
20.00	20.00	12.00	16.00	33.00	22.00	-	
24.00	24.00	12.00	20.00	35.00	27.00	-	
29.00	29.00	12.00	25.00	38.00	32.00	-	
36.00	36.00	15.00	32.00	43.00	40.00	-	
46.00	46.00	15.00	40.00	51.00	51.00	-	
55.00	55.00	15.00	50.00	57.00	61.00	-	
68.00	68.00	15.00	63.00	61.00	75.00	-	

Ordering data

Type	Order No.	Pcs. / Pkt.
G-ESIS-EMC-M12-S68N-NEPDS-S	1415148	10
G-ESIS-EMC-M16-S68N-NEPDS-S	1415149	10
G-ESIS-EMC-M20-S68N-NEPDS-S	1415163	10
G-ESIS-EMC-M25-M68N-NEPDS-S	1415165	10
G-ESIS-EMC-M32-M68L-NEPDS-S	1415166	5
G-ESIS-EMC-M40-M68L-NEPDS-S	1415168	5
G-ESIS-EMC-M50-L68L-NEPDS-S	1415169	1
G-ESIS-EMC-M63-L68L-NEPDS-S	1415170	1

Brass cable glands, metric, Ex protection

The cable glands for unarmored and braided cables provide flameproof (type “d”), increased safety (type “e”), and restricted breathing (type “nR”) protection.

– Degree of protection: IP66/IP67/IP68

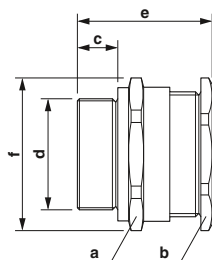

Brass cable gland

Notes:
For counter nuts, see page 685

Ex: CIDET EAC Ex NEPSI
SIRA13ATEX1068X / IECEx SIR13.0023X

General data

Cable gland material
Seal material
O-ring material
Ambient temperature (operation)

Technical data

Nickel-plated brass
Thermoplastic elastomers
Viton
-60 °C ... 130 °C

Thread type	Color	Clamping area [mm]	Dimensions [mm]						
			a	b	c	d	e	f	g
M20	silver	6.50 - 14.00	27.00	27.00	15.00	20.00	39.00	29.70	-
M25	silver	11.10 - 20.00	36.00	36.00	15.00	25.00	41.00	39.60	-
M32	silver	17.00 - 26.30	41.00	41.00	15.00	32.00	42.00	45.10	-
M40	silver	23.50 - 32.20	50.00	50.00	15.00	40.00	43.00	55.00	-
M50	silver	35.60 - 44.10	60.00	60.00	15.00	50.00	45.00	66.00	-
M63	silver	47.20 - 56.00	75.00	75.00	15.00	63.00	45.00	82.50	-

Dimensions [mm]							f	g
a	b	c	d	e	f	g		
27.00	27.00	15.00	20.00	39.00	29.70	-	-	
36.00	36.00	15.00	25.00	41.00	39.60	-	-	
41.00	41.00	15.00	32.00	42.00	45.10	-	-	
50.00	50.00	15.00	40.00	43.00	55.00	-	-	
60.00	60.00	15.00	50.00	45.00	66.00	-	-	
75.00	75.00	15.00	63.00	45.00	82.50	-	-	

Ordering data

Type	Order No.	Pcs. / Pkt.
G-ESS-M20-S66L-NTES-S	1411075	20
G-ESS-M25-M66L-NTES-S	1411077	20
G-ESS-M32-M66L-NTES-S	1411079	10
G-ESS-M40-L66L-NTES-S	1411081	2
G-ESS-M50-L66L-NTES-S	1411084	2
G-ESS-M63-L66L-NTES-S	1411086	2

Stainless steel cable glands, metric, Ex protection

The cable glands for unarmored and braided cables provide flameproof (type “d”), increased safety (type “e”), and restricted breathing (type “nR”) protection.

– Degree of protection: IP66/IP67/IP68

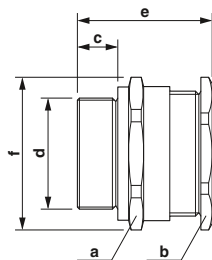

Stainless steel cable gland

Notes:
For counter nuts, see page 703

Ex: CIDET EAC Ex NEPSI
SIRA13ATEX1068X / IECEx SIR13.0023X

General data

Cable gland material
Seal material
O-ring material
Ambient temperature (operation)

Technical data

Stainless steel 1.4404
Thermoplastic elastomers
Viton
-60 °C ... 130 °C

Thread type	Color	Clamping area [mm]	Dimensions [mm]						
			a	b	c	d	e	f	g
M20	silver	6.50 - 14.00	27.00	27.00	15.00	20.00	39.00	29.70	-
M25	silver	11.10 - 20.00	36.00	36.00	15.00	25.00	41.00	39.60	-
M32	silver	17.00 - 26.30	41.00	41.00	15.00	32.00	42.00	45.10	-
M40	silver	23.50 - 32.20	50.00	50.00	15.00	40.00	43.00	55.00	-
M50	silver	35.60 - 44.10	60.00	60.00	15.00	50.00	45.00	66.00	-
M63	silver	47.20 - 56.00	75.00	75.00	15.00	63.00	45.00	82.50	-

Dimensions [mm]							f	g
a	b	c	d	e	f	g		
27.00	27.00	15.00	20.00	39.00	29.70	-	-	
36.00	36.00	15.00	25.00	41.00	39.60	-	-	
41.00	41.00	15.00	32.00	42.00	45.10	-	-	
50.00	50.00	15.00	40.00	43.00	55.00	-	-	
60.00	60.00	15.00	50.00	45.00	66.00	-	-	
75.00	75.00	15.00	63.00	45.00	82.50	-	-	

Ordering data

Type	Order No.	Pcs. / Pkt.
G-ESS-M20-S66L-STES-S	1411076	20
G-ESS-M25-M66L-STES-S	1411078	20
G-ESS-M32-M66L-STES-S	1411080	10
G-ESS-M40-L66L-STES-S	1411082	2
G-ESS-M50-L66L-STES-S	1411085	2
G-ESS-M63-L66L-STES-S	1411087	2

Installation and mounting material

Cable glands

Brass cable glands, metric, Ex protection

The cable glands for armored cables provide increased safety (type "e") protection.

– Degree of protection: IP66/IP67/IP68

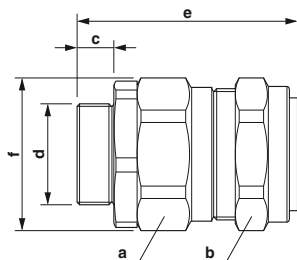

Brass cable gland

Notes:

For counter nuts, see page 685

Ex: CIDET EAC Ex NEPSI
SIRA13ATEX1070X / IECEx SIR13.0025X

Technical data

Nickel-plated brass
Thermoplastic elastomers
Viton
-60 °C ... 130 °C

General data

Cable gland material
Seal material
O-ring material
Ambient temperature (operation)

Ordering data

Thread type	Color	Clamping area [mm]
M20	silver	9.50 - 15.90
M20	silver	12.50 - 20.90
M25	silver	18.20 - 26.20
M32	silver	23.70 - 33.90
M40	silver	27.90 - 40.40
M50	silver	40.40 - 53.10
M63	silver	54.60 - 65.90

Dimensions [mm]							
a	b	c	d	e	f	g	
24.00	24.00	15.00	20.00	62.00	26.40	-	
30.50	30.50	15.00	20.00	65.00	33.60	-	
37.50	37.50	15.00	25.00	70.00	41.30	-	
46.00	46.00	15.00	32.00	73.00	50.60	-	
55.00	55.00	15.00	40.00	73.00	60.50	-	
70.00	70.00	15.00	50.00	75.00	77.00	-	
80.00	80.00	15.00	63.00	78.00	88.00	-	

Type	Order No.	Pcs. / Pkt.
G-ESSWU-M20S-S66L-NTES-S	1411088	10
G-ESSWU-M20-M66L-NTES-S	1411090	10
G-ESSWU-M25-M66L-NTES-S	1411092	10
G-ESSWU-M32-L66L-NTES-S	1411094	5
G-ESSWU-M40-L66L-NTES-S	1411097	1
G-ESSWU-M50-L66L-NTES-S	1411100	1
G-ESSWU-M63-L66L-NTES-S	1411102	1

Stainless steel cable glands, metric, Ex protection

The cable glands for armored cables provide flameproof (type "d"), increased safety (type "e"), and restricted breathing (type "nR") protection.

– Degree of protection: IP66/IP67/IP68

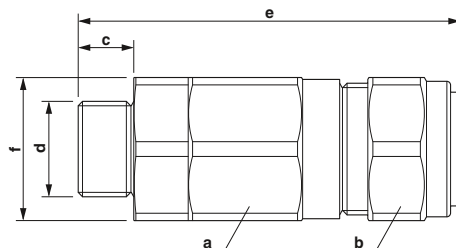

Stainless steel cable gland

Notes:

For counter nuts, see page 703

Ex: CIDET EAC Ex NEPSI
SIRA13ATEX1073X / IECEx SIR13.0028X

Technical data

Stainless steel 1.4404
Thermoplastic elastomers
Viton
-60 °C ... 130 °C

General data

Cable gland material
Seal material
O-ring material
Ambient temperature (operation)

Ordering data

Thread type	Color	Clamping area [mm]
M20	silver	9.50 - 15.90
M20	silver	12.50 - 20.90
M25	silver	18.20 - 26.20
M32	silver	23.70 - 33.90
M40	silver	27.90 - 40.40
M50	silver	40.40 - 53.10
M63	silver	54.60 - 65.90

Dimensions [mm]							
a	b	c	d	e	f	g	
24.00	24.00	15.00	20.00	85.00	26.40	-	
30.50	30.50	15.00	20.00	87.00	33.60	-	
37.50	37.50	15.00	25.00	97.00	41.30	-	
46.00	46.00	15.00	32.00	100.00	50.60	-	
55.00	55.00	15.00	40.00	101.00	60.50	-	
70.00	70.00	15.00	50.00	115.00	77.00	-	
80.00	80.00	15.00	63.00	118.00	88.00	-	

Type	Order No.	Pcs. / Pkt.
G-EDSWU-M20S-S66L-STES-S	1411089	10
G-EDSWU-M20-M66L-STES-S	1411091	10
G-EDSWU-M25-M66L-STES-S	1411093	10
G-EDSWU-M32-L66L-STES-S	1411095	5
G-EDSWU-M40-L66L-STES-S	1411099	1
G-EDSWU-M50-L66L-STES-S	1411101	1
G-EDSWU-M63-L66L-STES-S	1411103	1

Brass screw plugs, metric, Ex protection

Screw plugs provide IP66 and IP68 protection when installed with an entry thread ring, sealing unused cable entries in flameproof (type "d") and increased safety (type "e") installations.

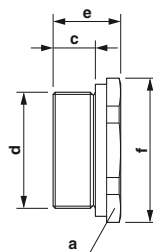

Brass screw plug

Notes:
For counter nuts, see page 685

Ex: SIRAO1ATEX1284U / IECEx SIR07.0083X

General data	
Material	
Ambient temperature (operation)	

Technical data

Nickel-plated brass
-60 °C ... 200 °C

Thread type	Color	Clamping area [mm]	Dimensions [mm]						
			a	b	c	d	e	f	g
M20	silver	-	24.00	-	15.00	20.00	24.00	26.40	-
M25	silver	-	30.00	-	15.00	25.00	24.00	33.00	-
M32	silver	-	36.00	-	15.00	32.00	24.00	39.60	-
M40	silver	-	46.00	-	15.00	40.00	24.00	50.60	-
M50	silver	-	55.00	-	15.00	50.00	24.00	60.50	-
M63	silver	-	65.00	-	15.00	63.00	24.00	77.00	-

Ordering data

Type	Order No.	Pcs. / Pkt.
A-EXSH-M20-68L-N-S	1411104	20
A-EXSH-M25-68L-N-S	1411107	20
A-EXSH-M32-68L-N-S	1411109	10
A-EXSH-M40-68L-N-S	1411111	5
A-EXSH-M50-68L-N-S	1411113	2
A-EXSH-M63-68L-N-S	1411115	1

Stainless steel screw plugs, metric, Ex protection

Screw plugs provide IP66 and IP68 protection when installed with an entry thread ring, sealing unused cable entries in flameproof (type "d") and increased safety (type "e") installations.

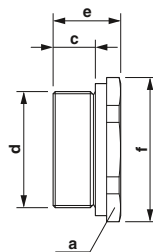

Stainless steel screw plug

Notes:
For counter nuts, see page 703

Ex: SIRAO1ATEX1284U / IECEx SIR07.0083X

General data	
Material	
Ambient temperature (operation)	

Technical data

Stainless steel 1.4404
-60 °C ... 200 °C

Thread type	Color	Clamping area [mm]	Dimensions [mm]						
			a	b	c	d	e	f	g
M20	silver	-	24.00	-	15.00	20.00	24.00	26.40	-
M25	silver	-	30.00	-	15.00	25.00	24.00	33.00	-
M32	silver	-	36.00	-	15.00	32.00	24.00	39.60	-
M40	silver	-	46.00	-	15.00	40.00	24.00	50.60	-
M50	silver	-	55.00	-	15.00	50.00	24.00	60.50	-
M63	silver	-	65.00	-	15.00	63.00	24.00	77.00	-

Ordering data

Type	Order No.	Pcs. / Pkt.
A-EXSH-M20-68L-S-S	1411105	20
A-EXSH-M25-68L-S-S	1411108	20
A-EXSH-M32-68L-S-S	1411110	10
A-EXSH-M40-68L-S-S	1411112	5
A-EXSH-M50-68L-S-S	1411114	2
A-EXSH-M63-68L-S-S	1411116	1

Installation and mounting material

Cable glands

Brass pressure compensation, metric, Ex protection

Breather/drain plugs for increased safety (type "e") provide superior ventilation for devices. They are designed to act as a pressure compensation element preventing moisture build-up to IP66.

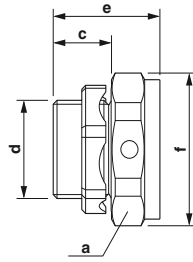

Brass pressure compensation

Notes:
For counter nuts, see page 685

Ex: EAC Ex NEPSI
SIRA10ATEX1307U / IECEx SIR10.0149U

General data		
Material		
Ambient temperature (operation)		

Technical data

Nickel-plated brass
-60 °C ... 130 °C

Thread type	Color	Clamping area [mm]
M20	silver	-
M25	silver	-

Dimensions [mm]						
a	b	c	d	e	f	g
30.00	-	15.00	20.00	32.00	33.00	-
31.50	-	15.00	25.00	32.00	39.60	-

Ordering data

Type	Order No.	Pcs. / Pkt.
A-EXB-20-66L-N-S	1411117	5
A-EXB-25-66L-N-S	1411120	5

Stainless steel pressure compensation, metric, Ex protection

Breather/drain plugs for increased safety (type "e") provide superior ventilation for devices. They are designed to act as a pressure compensation element preventing moisture build-up to IP66.

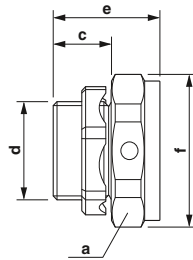

Stainless steel pressure compensation

Notes:
For counter nuts, see page 703

Ex: EAC Ex NEPSI
SIRA10ATEX1307U / IECEx SIR10.0149U

General data		
Material		
Ambient temperature (operation)		

Technical data

Stainless steel 1.4404
-60 °C ... 130 °C

Thread type	Color	Clamping area [mm]
M20	silver	-
M25	silver	-

Dimensions [mm]						
a	b	c	d	e	f	g
30.00	-	15.00	20.00	32.00	26.40	-
31.50	-	15.00	25.00	32.00	33.00	-

Ordering data

Type	Order No.	Pcs. / Pkt.
A-EXB-20-66L-S-S	1411118	5
A-EXB-25-66L-S-S	1411121	5

Stainless steel counter nuts, metric

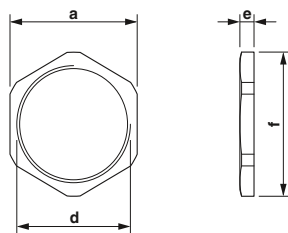

Stainless steel counter nut

General data

Material
Ambient temperature (operation)

Technical data

Stainless steel 1.4305
-70 °C ... 220 °C

Ordering data

Thread type	Color	Clamping area [mm]	Dimensions [mm]						
			a	b	c	d	e	f	g
M20	silver	-	24.00	-	-	20.00	3.00	27.00	-
M25	silver	-	30.00	-	-	25.00	3.50	33.50	-
M32	silver	-	36.00	-	-	32.00	4.00	40.00	-
M40	silver	-	46.00	-	-	40.00	5.00	50.00	-
M50	silver	-	55.00	-	-	50.00	5.00	65.00	-
M63	silver	-	70.00	-	-	63.00	6.00	75.00	-

Type	Order No.	Pcs. / Pkt.
A-INL-M20-S-S	1411249	10
A-INL-M25-S-S	1411250	10
A-INL-M32-S-S	1411251	5
A-INL-M40-S-S	1411252	5
A-INL-M50-S-S	1411253	2
A-INL-M63-S-S	1411254	1

Sealing washers, metric

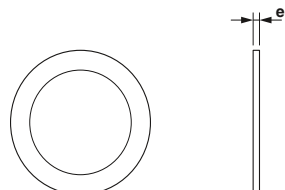

Sealing washer

General data

Material
Ambient temperature (operation)

Technical data

Nylon
-70 °C ... 100 °C

Ordering data

Thread type	Color	Clamping area [mm]	Dimensions [mm]						
			a	b	c	d	e	f	g
M20	white	-	-	-	-	-	2.00	-	-
M25	white	-	-	-	-	-	2.00	-	-
M32	white	-	-	-	-	-	2.00	-	-
M40	white	-	-	-	-	-	2.00	-	-
M50	white	-	-	-	-	-	2.00	-	-
M63	white	-	-	-	-	-	2.00	-	-

Type	Order No.	Pcs. / Pkt.
A-SEW-20-P-W	1411283	20
A-SEW-25-P-W	1411284	20
A-SEW-32-P-W	1411285	20
A-SEW-40-P-W	1411286	20
A-SEW-50-P-W	1411287	10
A-SEW-63-P-W	1411288	10

Installation and mounting material

Service interfaces

Mounting frame, front plates and socket inserts

Notes:
For RJ45 socket inserts, see page 708



EMC mounting frame for front plates



Mounting frame for front plates

	Technical data			Technical data		
Electrical data	VS-SI-EB-EMV-...			SI-M...		
Rated voltage	-			-		
Rated current	-			-		
Housing material	Zinc alloy			PBT		
Inflammability class according to UL 94	V0			V0		
Degree of protection	IP65			IP65		
Connection method	-			-		
Conductor cross section	-			-		
Connection cross section AWG	-			-		
Ambient temperature (operation)	-10 °C ... 60 °C			-30 °C ... 70 °C		
	Ordering data			Ordering data		
Description	Type	Order No.	Pcs. / Pkt.	Type	Order No.	Pcs. / Pkt.
Mounting frame , metal frame, matt nickel-plated, electrically conductive, transparent cover						
Single	VS-SI-EB-EMV-1	1656482	1	SI-M1A	1404493	1
Double	VS-SI-EB-EMV-2	1656495	1	SI-M1B	1404494	1
Mounting frame , black, transparent PC plastic cover, closed with 3 mm two-way key bit						
Single				SI-M1A-T	1407586	1
Double				SI-M1B-T	1407587	1
Mounting frame , black, transparent PC plastic cover, closed with turn knob						
Single				SI-M1A-ML	1407588	1
Double				SI-M1B-ML	1407589	1
Mounting frame , black, metallic ABS plastic cover, closed with 3 mm two-way key bit						
Single				SI-M1A-MT	1407590	1
Double				SI-M1B-MT	1407591	1
Mounting frame , black, metallic ABS plastic cover, closed with turn knob						
Single				SI-M1A-GL	1407592	1
Double				SI-M1B-GL	1407593	1
Mounting frame , black, gray PBT plastic cover, closed with 3 mm two-way key bit						
Single				SI-M1A-GT	1407594	1
Double				SI-M1B-GT	1407595	1
Front plate						
2 x RJ (with shroud)						
2 x D-SUB 09						
1 x D-SUB 09, 1 x D-SUB 15						
1 x D-SUB 09, 1 x D-SUB 25						
2 x D-SUB 15						
1 x D-SUB 15, 1 x D-SUB 25						
2 x D-SUB 25						
Socket inserts						
Germany						
Germany, yellow						
USA						
France						
Great Britain						
Italy						
	Accessories			Accessories		
Marker labels , for identifying mounting frames and front plates, one sheet has 20 labels	VS-SI-BZ	1656660	1	VS-SI-BZ	1656660	1
Dummy plate , plastic				VS-SI-FP-BP	1656657	1

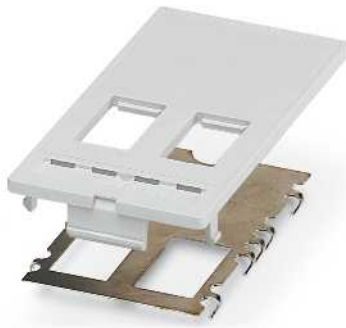

Front plate,
without contact inserts



Data front plate
with contact inserts RJ45 (socket to socket),
D-SUB (socket to pin)



Socket inserts

ERC

Technical data	
VS-SI-FP-2RJ-MOD	
-	
-	
PBT	
V0	
-	
-	
-	
-10 °C ... 60 °C	

Technical data	
VS-SI-FP...RJ45...	VS-SI-FP...DSUB...
50 V	125 V
1 A	3 A
PBT	PBT
V0	V0
IP20	IP20
-	-
-	-
-	-
-10 °C ... 60 °C	-10 °C ... 60 °C

ERC

Technical data	
VS-SI-SD-DE	VS-SI-SD-USA
250 V	125 V
16 A	15 A
PA	PA
V0	V0
IP20	IP20
Screw connection	Slip-on connection
2.5 mm ²	2.5 mm ²
14	14
-10 °C ... 60 °C	-10 °C ... 60 °C

Ordering data

Type	Order No.	Pcs. / Pkt.
VS-SI-FP-2RJ-MOD	1656631	1
VS-SI-FP-2DSUB9	1656563	1
VS-SI-FP-DSUB9-DSUB15	1656576	1
VS-SI-FP-DSUB9-DSUB25	1656589	1
VS-SI-FP-2DSUB15	1656592	1
VS-SI-FP-DSUB15-DSUB25	1656602	1
VS-SI-FP-2DSUB25	1656615	1

Ordering data

Type	Order No.	Pcs. / Pkt.
VS-SI-FP-2RJ45-5-MOD-BU/BU	1657766	1
VS-SI-FP-2DSUB9-GC-BU/ST	1657708	1
VS-SI-FP-DSUB9-DSUB15-GC-BU/ST	1657711	1
VS-SI-FP-DSUB9-DSUB25-GC-BU/ST	1657724	1
VS-SI-FP-2DSUB15-GC-BU/ST	1657737	1
VS-SI-FP-DSUB15DSUB25-GC-BU/ST	1657740	1
VS-SI-FP-2DSUB25-GC-BU/ST	1657753	1

Ordering data

Type	Order No.	Pcs. / Pkt.
VS-SI-SD-DE	1656505	1
VS-SI-SD-DE-G	1656518	1
VS-SI-SD-USA	1656521	1
VS-SI-SD-FR	1656534	1
VS-SI-SD-GB	1656547	1
VS-SI-SD-IT	1656550	1

Accessories

--	--	--

Accessories

--	--	--

Accessories

--	--	--

Installation and mounting material

Service interfaces

Data front plates, service sockets, and programming interfaces



Front plates



Service sockets

	Technical data			Technical data		
Material data						
Housing material	PBT			PA		
Mechanical data						
Degree of protection	IP20			IP65		
Temperature data						
Ambient temperature (operation)	-10 °C ... 60 °C			-25 °C ... 70 °C		
	Ordering data			Ordering data		
Description	Type	Order No.	Pcs. / Pkt.	Type	Order No.	Pcs. / Pkt.
Front plate , with the following contact inserts:						
D-SUB9	SI-FP-D1A	1404501	1			
D-SUB9, D-SUB9-BP	SI-FP-D1D-D1E	1404509	1			
2x D-SUB 9	SI-FP-2D1D	1404510	1			
D-SUB9, D-SUB9, RJ45	SI-FP-R1A-D1A-D1C	1404507	1			
D-SUB9, RJ45	SI-FP-R1A-D1A	1404496	1			
D-SUB9, D-SUB25, RJ45	SI-FP-R1A-D1B-D3B	1404502	1			
D-SUB9, RJ45, USB with 0.7 m cable	SI-FP-R1A-D1B-U1A/0,7	1404504	1			
D-SUB9 BP, RJ45	SI-FP-R1A-D1E	1404500	1			
RJ45, RJ12, 2 x USB	SI-FP-R1A-R2A-2U1A	1404503	1			
RJ45, USB	SI-FP-R1A-U1A	1404499	1			
RJ45, USB with 0.7 m cable	SI-FP-R1A-U1A/0,7	1404512	1			
D-SUB9, RJ45, USB	SI-FP-R1A-U1A-D1A	1404497	1			
D-SUB9, RJ45, USB	SI-FP-R1A-U1A-D1B	1404495	1			
2x RJ45, USB	SI-FP-2R1A-U1A	1404506	1			
USB	SI-FP-U1A	1404505	1			
Service sockets						
RJ45				SI-SES-R1A	1404513	1
USB with 0.6 m cable				SI-SES-U1A/0,6	1404514	1
USB with 1.0 m cable				SI-SES-U1A/1	1404515	1
Programming interface for HEAVYCON panel mounting base, with:						
2x RJ45 gender changers						
2x USB (A), D-SUB15						
RJ45						
RJ45, RJ11						
RJ45, socket insert USA						
RJ45, socket insert USA 3A						
USB (A)						



Programming interfaces

ERC

Technical data
Aluminum die-cast
IP54
-35 °C ... 65 °C

Ordering data		
Type	Order No.	Pcs. / Pkt.
SI-PP-2R1A	1404520	1
SI-PP-2U1A-D2A	1404519	1
SI-PP-R1A	1404517	1
SI-PP-R1A-R3A	1404521	1
SI-PP-R1A-S0A	1404516	1
SI-PP-R1A-S0B	1404518	1
SI-PP-U1A	1404522	1

Service interfaces

Front plate and socket inserts (Freenet system)



Front plate
with two Freenet slots

Ethernet



RJ45 socket inserts,
Freenet system

ERC

	Technical data			Technical data		
	VS-SI-FP-2F	VS-08-BU/BU-RJ45-F	VS-08-BU-RJ45-6-F/PK			
Electrical data						
Rated voltage	-	50 V	50 V			
Rated current	-	1 A	1 A			
Transmission speed	-	-	-			
Transmission characteristics (category)	-	-	-			
Material data						
Housing material	PBT	Copper alloy	-			
Contact material	-	Copper alloy	Copper alloy			
Contact surface material	-	Gold over nickel	Gold over nickel			
Contact carrier material	-	PC	PC			
Ferrule material	-	-	-			
Inflammability class according to UL 94	V0	V0	V0			
Mechanical data						
No. of pos.	-	8	8			
Pollution degree	-	1	1			
Degree of protection	IP20	IP20	IP20			
Connection method	-	IDC	IDC			
Conductor cross section	-	0.2 mm ² ... 0.32 mm ² (solid)	0.14 mm ² ... 0.35 mm ²			
Connection cross section AWG	-	24 ... 22 (solid)	26 ... 22 (7-wire)			
Fiber type	-	-	-			
Insertion/withdrawal cycles	-	≥ 750	≥ 750			
Temperature data						
Ambient temperature (operation)	-10 °C ... 60 °C	-20 °C ... 70 °C	-20 °C ... 70 °C			
	Ordering data			Ordering data		
Description	Type	Order No.	Pcs. / Pkt.	Type	Order No.	Pcs. / Pkt.
Front plate	VS-SI-FP-2F	1658532	1			
RJ45 Freenet socket insert , 8-pos., shielded, socket to socket 1 Gbps, CAT5				VS-08-BU/BU-RJ45-F	1405617	1
RJ45 Freenet socket insert , 8-pos., shielded, with cable connection 1 Gbps, CAT5				VS-08-BU-RJ45-5-F/PK	1652936	1
SC-RJ coupling , for VS-TO-... terminal outlets and 19" VS-PP-19-1HE-16-F patch panels and VS-SI-FP-2F front plate						
USB socket insert , 4-pos., version 6, panel mounting frame with USB coupling: Slot V6 with USB-A Slot V6 with USB-B						
USB socket insert , 4-pos., socket on flat-ribbon cable terminal strip, pitch 2.54 Socket, type A Socket, type B						
	Accessories			Accessories		
Marker labels , for identifying mounting frames and front plates, one sheet has 20 labels	VS-SI-BZ	1656660	1			

Ethernet



SC-RJ coupling



Panel mounting frame,
USB socket insert

Technical data	
VS-SCRJ-GOF-KU	
-	-
-	-
-	-
PBT	-
-	-
-	-
Zirconia ceramics	-
V0	-
2	-
-	-
IP20	-
Coupling	-
-	-
-	-
GOF, PCF, POF	-
≥ 500	-
-25 °C ... 70 °C	

Technical data	
CUC-V06-F1PGY-UBA/UB...	VS-04-BUA-FK-F/IP67
30 V	30 V
1 A	1 A
-	-
-	-
PC	PC
Copper alloy	Copper alloy
Gold over nickel	Gold over nickel
Thermoplastic	PET
-	-
V0	V0
4	4
-	-
IP67	IP20
USB type A, socket	Flat-ribbon cable connection, pitch 2.54 mm
-	-
-	-
-	-
-	≥ 1000
-15 °C ... 65 °C	

Ordering data		
Type	Order No.	Pcs. / Pkt.
VS-SCRJ-GOF-KU	1654358	1

Ordering data		
Type	Order No.	Pcs. / Pkt.
CUC-V06-F1PGY-UBA/UBBB	1411904	1
CUC-V06-F1PGY-UBB/UBAB	1411905	1
VS-04-BUA-FK-F/IP67	1653854	1
VS-04-BUB-FK-F/IP67	1653867	1

Accessories		

Accessories		



Cable marking

The cables are supplied with marked marking collars. Suitable marking materials are available for each marking system.



Distributor box marking

High-quality marking materials for individual marking of distributor boxes are available for each marking system.



Connector marking

Marking materials ranging from adhesive labels to high-quality engraved labels are available for marking heavy-duty connectors.



Cable markers

Markers can be fitted using cable binders almost regardless of cable diameter. The large marking area provides enough space for comprehensive marking.



Cable marker labels

Cable marker labels consist of a marking field and a transparent film that protects the marking against abrasion and dirt.



Plastic cable markers

Plastic cable markers are suitable for bundling and marking cables. The marking is protected against dirt and can be replaced.



Cable protection

The comprehensive range of plastic and metal protective hoses offers the right solution for every application. Protective hose screw connections with tool-free quick mounting function and various IP protection classes round off the range of products.

Find out more with the web code

Detailed information on these products can be found on our website. Simply enter # and numbers in the search field.

#0006

Search





Plug-in charging systems for E-Mobility

Phoenix Contact E-Mobility offers a product and technology portfolio that enables the flexible, modular, and efficient implementation of various concepts for the charging infrastructure for different business models. Whether charging on an AC power grid or rapid DC charging – the AC and DC charging systems from Phoenix Contact are safe, reliable, and user-friendly.

Product range overview	714
DC charging cables	716
AC charging cables	718
Mobile AC charging cables	722
Infrastructure Socket Outlets	726



The development of a widespread charging infrastructure in conjunction with renewable energy is an important step toward a mobile future. Internationally standardized charging systems are used to establish an electrical connection between the electric vehicle and the infrastructure (e.g., a charging station). In terms of the charging interfaces required, a distinction is made between:

- Vehicle inlets
- Infrastructure Socket Outlets
- Charging cables with Vehicle Connectors, Infrastructure Plugs, and integrated IC-CPD control units

International standards ensure uniform connection for charging stations and vehicles:

- Type 1 according to SAE J1772 and IEC 62196 (USA, Japan)
- Type 2 according to IEC 62196 (Europe)
- GB/T 20234 standard (China)

The charging systems from Phoenix Contact offer reliable, standard-compliant solutions for a consistent charging interface for all applications.

This is implemented, for example, with the Combined Charging System (CCS), which was developed by major German automobile manufacturers in cooperation with Phoenix Contact. The electric vehicle can be charged conventionally with AC at home, for example. In addition, the vehicle-side inlet is also designed for rapid DC charging. Only short stops are required for the charging process - e.g., at rest stops when on the road.



AC type 1

AC charging system Type 1 is based on the SAE J1772 and IEC 62196 standard. It is primarily used in the USA and Japan. The lock is implemented using a lever system.



AC type 2

The type 2 AC charging system, developed for Europe, is designed according to the IEC 62196-2 standard. It supports single- and three-phase charging. An electromechanical actuator lock safeguards the charging process.



AC GB/T

The AC charging system standardized according to the Chinese GB/T standard supports both single and three-phase charging. Charging takes place securely thanks to a special lever system.



DC CCS type 1

In the USA, the type 1 DC CCS charging system is used for fast DC charging, according to SAE J1772 and IEC 62196-3. The lever locking mechanism is also supported by an additional actuator lock.



DC CCS type 2

In Europe, the type 2 DC CCS charging system is the vanguard for rapid DC charging according to IEC 62196-3. The electromechanical actuator lock prevents premature removal during the charging process.



DC GB/T

The DC charging system for China is based on the GB/T standard. It offers rapid DC charging for Chinese charging stations. The locking mechanism is integrated in the Vehicle Connector.

Plug-in charging systems for E-Mobility

DC charging cables

Combined charging system (CCS) DC charging cables type 1 and type 2

The CCS DC charging cables with open cable end are connected directly to a DC charging station. They are suitable for fast DC charging of electric vehicles.

The CCS Vehicle Connector is compatible with the CCS Vehicle Inlet, which also accommodates an AC Vehicle Connector.



CCS Type 1 Vehicle Connector,
with AWG cable



CCS Type 2 Vehicle Connector,
with metric cable

Notes:
Further cable types and lengths are available on request.
Color variants for housing and cables are available on request.

	Technical data		Technical data							
	60 A	125 A	60 A	125 A	200 A					
Rated current	60 A	125 A	60 A	125 A	200 A					
Rated voltage	600 V DC	600 V DC	850 V DC	850 V DC	850 V DC					
Approvals	-	-	-		-					
Standards	SAE J1772	SAE J1772	IEC 62196-3	IEC 62196-3	IEC 62196-3					
Charging mode	DC level 2	DC level 2	Mode 4	Mode 4	Mode 4					
Resistor coding	480 Ω (Lever actuated) 150 Ω (Lever not actuated)	480 Ω (Lever actuated) 150 Ω (Lever not actuated)	1500 Ω (between PE and PP)	1500 Ω (between PE and PP)	1500 Ω (between PE and PP)					
Ambient temperature (operation)	-30 °C ... 50 °C	-30 °C ... 50 °C	-30 °C ... 50 °C	-30 °C ... 50 °C	-30 °C ... 50 °C					
Number of power contacts	3 (PE, DC+, DC-)	3 (PE, DC+, DC-)	3 (PE, DC+, DC-)	3 (PE, DC+, DC-)	3 (PE, DC+, DC-)					
Insertion/withdrawal cycles	> 10000	> 10000	> 10000	> 10000	> 10000					
Insertion/withdrawal force	< 100 N	< 100 N	< 100 N	< 100 N	< 100 N					
Temperature sensor	Pt 1000	Pt 1000	Pt 1000	Pt 1000	Pt 1000					
Type of protection (when plugged in)	IP44	IP44	IP44	IP44	IP44					
Degree of protection (when not plugged in)	IP20	IP20	IP20	IP20	IP20					
Cable data										
Cable type	Straight	Straight	Straight	Straight	Straight					
Cable length	5 m	5 m	4,5 m	5 m	5 m					
Cable diameter	20.6 mm ±0.2 mm	32.2 mm ±0.2 mm	18.5 mm ±0.2 mm	28.2 mm ±0.2 mm	32 mm ±0.2 mm					
Cable structure	3 x 6 AWG + 3 x 2 x 18 AWG	2 x 1 AWG + 1 x 3 AWG + 3 x 2 x 18 AWG	3 x 16 mm ² + 3 x 2 x 0.75 mm ²	2 x 50 mm ² + 1 x 25 mm ² + 3 x 2 x 0.75 mm ²	2 x 70 mm ² + 1 x 35 mm ² + 3 x 2 x 0.75 mm ²					
Sheath color	Black	Black	Black	Black	Black					
Ordering data										
Description	Order No.	Pcs. / Pkt.	Order No.	Pcs. / Pkt.	Order No.	Pcs. / Pkt.				
	60 A		125 A		60 A	125 A	200 A			
DC charging cable with Vehicle Connector and open cable end, Combined Charging System (CCS)	1621488	1	1409950	1	1618306	1	1409060	1	1621653	1

DC charging cables GB/T (China)

DC GB charging cables with open cable end are installed in Chinese charging stations with a stationary AC/DC converter. They are suitable for fast DC charging of electric vehicles.

An innovative locking mechanism is integrated in the Vehicle Connector for secure locking during the charging process.



GB/T DC Vehicle Connector, with metric cable

Notes:
Further cable types and lengths are available on request.
Color variants for housing and cables are available on request.
All Vehicle Connectors are supplied with a protective cap.

	Technical data		
	60 A	125 A	250 A
Rated current	60 A	125 A	250 A
Rated voltage	750 V DC	750 V DC	750 V DC
Standards	GB/T 20234.3	GB/T 20234.3	GB/T 20234.3
Charging mode	Mode 4	Mode 4	Mode 4
Resistor coding	1000 Ω	1000 Ω	1000 Ω
Ambient temperature (operation)	-30 °C ... 50 °C	-30 °C ... 50 °C	-30 °C ... 50 °C
Number of power contacts	3 (PE, DC+, DC-)	3 (PE, DC+, DC-)	3 (PE, DC+, DC-)
Insertion/withdrawal cycles	> 10000	> 10000	> 10000
Insertion/withdrawal force	< 100 N	< 100 N	< 100 N
Temperature sensor	Pt 1000	Pt 1000	Pt 1000
Type of protection (when plugged in)	IP55	IP55	IP55
Degree of protection (with protective cap)	IP54	IP54	IP54
Cable data			
Cable type	Straight	Straight	Straight
Cable length	5 m	5 m	5 m
Cable diameter	20.2 mm ±0.2 mm	28 mm ±0.2 mm	32.4 mm ±0.2 mm
Cable structure	3 x 16 mm ² + 2 x 2.5 mm ² + 9 x 0.5 mm ²	2 x 50 mm ² + 1 x 16 mm ² + 2 x 2.5 mm ² + 9 x 0.5 mm ²	2 x 70 mm ² + 1 x 25 mm ² + 2 x 2.5 mm ² + 9 x 0.5 mm ²
Sheath color	Black	Black	Black

Description	Ordering data					
	Order No.	Pcs. / Pkt.	Order No.	Pcs. / Pkt.	Order No.	Pcs. / Pkt.
DC charging cable with Vehicle Connector and open cable end, GB/T	60 A		125 A		250 A	
	1621468	1	1622119	1	1622120	1

Plug-in charging systems for E-Mobility

AC charging cables

AC charging cables type 1 with open cable end

Type 1 AC charging cables with open cable end are primarily installed in charging stations and wall boxes in the USA and Japan. They are used to charge electric vehicles with alternating current.

Notes:
Further cable types and lengths are available on request.
Color variants for housing, cables, and customer-specific labels available on request.
All Vehicle Connectors are supplied with a protective cap.



AC Type 1 Vehicle Connector, with metric cable



AC Type 1 Vehicle Connector, with AWG cable

	Technical data		Technical data					
	20 A, 1-phase	32 A, 1-phase	16 A, 1-phase	30 A, 1-phase				
Rated current	20 A	32 A	16 A	30 A				
Number of phases	1	1	1	1				
Rated voltage	250 V AC	250 V AC	240 V AC	240 V AC				
Standards	IEC 62196-2	IEC 62196-2	SAE J1772	SAE J1772				
Charging mode	Mode 3	Mode 3	AC level 2	AC level 2				
Resistor coding	480 Ω (Lever actuated) 150 Ω (Lever not actuated)	480 Ω (Lever actuated) 150 Ω (Lever not actuated)	480 Ω (Lever actuated) 150 Ω (Lever not actuated)	480 Ω (Lever actuated) 150 Ω (Lever not actuated)				
Ambient temperature (operation)	-30 °C ... 50 °C	-30 °C ... 50 °C	-30 °C ... 50 °C	-30 °C ... 50 °C				
Number of power contacts	3 (L1, N, PE)	3 (L1, N, PE)	3 (L1, N, PE)	3 (L1, N, PE)				
Insertion/withdrawal cycles	> 10000	> 10000	> 10000	> 10000				
Insertion/withdrawal force	< 100 N	< 100 N	< 100 N	< 100 N				
Type of protection (when plugged in)	IP44	IP44	IP44	IP44				
Degree of protection (with protective cap)	IP44	IP44	IP44	IP44				
Cable data								
Cable length	4 m	4 m	4 m	4 m				
Cable diameter	10.5 mm ±0.5 mm	13.9 mm ±0.5 mm	9.4 mm ±0.2 mm	16.4 mm ±0.2 mm				
Cable structure	3 x 2.5 mm ² + 1 x 0.5 mm ²	3 x 6 mm ² + 1 x 0.5 mm ²	3 x 14 AWG + 1 x 18 AWG	3 x 10 AWG + 1 x 18 AWG				
Sheath color	Black	Black	Black	Black				
	Ordering data		Ordering data					
Description	Order No.	Pcs. / Pkt.	Order No.	Pcs. / Pkt.	Order No.	Pcs. / Pkt.	Order No.	Pcs. / Pkt.
	20 A, 1-phase		32 A, 1-phase		16 A, 1-phase		30 A, 1-phase	
AC charging cable with Type 1 Vehicle Connector and straight cable with open cable end	1621482	1	1409952	1	1621484	1	1409949	1
AC charging cable with Type 1 Vehicle Connector and spiraled cable with open cable end	1621670	1	1621794	1				

AC charging cables GB/T with open cable end

The AC charging cables with open cable end according to the GB/T standard are specially designed for the Chinese charging infrastructure. They are used to charge electric vehicles in China with alternating current at GB/T charging stations and wall boxes.



AC GB/T Vehicle Connector, with metric cable



AC GB/T Vehicle Connector, with metric cable

Notes:
Further cable types and lengths are available on request.
Color variants for housing, cables, and customer-specific labels available on request.
All Vehicle Connectors are supplied with a protective cap.

	Technical data		Technical data	
	16 A, 1-phase		32 A, 1-phase	32 A, 3-phase
Rated current	16 A	32 A	32 A	
Number of phases	1	1	3	
Rated voltage	250 V	250 V	440 V	
Standards	GB/T 20234.2	GB/T 20234.2	GB/T 20234.2	
Charging mode	Mode 3	Mode 3	Mode 3	
Resistor coding	680 Ω (between PE and CC)	220 Ω (between PE and CC)	220 Ω (between PE and CC)	
Ambient temperature (operation)	-30 °C ... 50 °C	-30 °C ... 50 °C	-30 °C ... 50 °C	
Number of power contacts	3 (L1, N, PE)	3 (L1, N, PE)	5 (L, NC1, NC2, N, PE)	
Insertion/withdrawal cycles	> 10000	> 10000	> 10000	
Insertion/withdrawal force	< 100 N	< 100 N	< 100 N	
Type of protection (when plugged in)	IP55	IP55	IP55	
Degree of protection (with protective cap)	IP54	IP54	IP54	
Cable data				
Cable type	Straight	Straight	Straight	
Cable length	5 m	5 m	5 m	
Cable diameter	10,5 mm	13,9 mm	17,1 mm	
Cable structure	3 x 2,5 mm ² + 1 x 0,5 mm ²	3 x 6,0 mm ² + 1 x 0,5 mm ²	5 x 6,0 mm ² + 1 x 0,5 mm ²	
Sheath color	Orange	Orange	Orange	
Ordering data				
Description	Order No.	Pcs. / Pkt.	Order No.	Pcs. / Pkt.
	16 A, 1-phase		32 A, 1-phase	
AC charging cable with GB/T Vehicle Connector and open cable end	1408166	1	1408167	1
			1408168	1

Plug-in charging systems for E-Mobility

AC charging cables

AC charging cables type 2 with open cable end

AC charging cables Type 2 with open cable end are installed in charging stations and wall boxes in European infrastructure. They are used to charge electric vehicles with single or three-phase alternating current.

Notes:
Further cable types and lengths are available on request.
Color variants for housing, cables, and customer-specific labels available on request.
All Vehicle Connectors are supplied with a protective cap.



AC Type 2 Vehicle Connector, with metric cable



AC Type 2 Vehicle Connector, with metric cable



	Technical data		Technical data	
	20 A, 1-phase	20 A, 3-phase	32 A, 1-phase	32 A, 3-phase
Rated current	20 A	20 A	32 A	32 A
Number of phases	1	3	1	3
Rated voltage	250 V AC	480 V AC	250 V AC	480 V AC
Standards	IEC 62196-2	IEC 62196-2	IEC 62196-2	IEC 62196-2
Charging mode	Mode 3	Mode 3	Mode 3	Mode 3
Resistor coding	680 Ω (between PE and PP)	680 Ω (between PE and PP)	220 Ω (between PE and PP)	220 Ω (between PE and PP)
Ambient temperature (operation)	-30 °C ... 50 °C	-30 °C ... 50 °C	-30 °C ... 50 °C	-30 °C ... 50 °C
Number of power contacts	3 (L1, N, PE)	5 (L1, L2, L3, N, PE)	3 (L1, N, PE)	5 (L1, L2, L3, N, PE)
Insertion/withdrawal cycles	> 10000	> 10000	> 10000	> 10000
Insertion/withdrawal force	< 100 N	< 100 N	< 100 N	< 100 N
Type of protection (when plugged in)	IP44	IP44	IP44	IP44
Degree of protection (with protective cap)	IP44	IP44	IP44	IP44
Cable data				
Cable length	4 m	4 m	4 m	4 m
Cable diameter	10,5 mm ±0,5 mm	13 mm ±0,5 mm	13,9 mm ±0,5 mm	17 mm ±0,5 mm
Cable structure	3 x 2,5 mm ² + 1 x 0,5 mm ²	5 x 2,5 mm ² + 1 x 0,5 mm ²	3 x 6 mm ² + 1 x 0,5 mm ²	5 x 6 mm ² + 1 x 0,5 mm ²
Sheath color	Black	Black	Black	Black
	Ordering data		Ordering data	
Description	Order No.	Pcs. / Pkt.	Order No.	Pcs. / Pkt.
	20 A, 1-phase		20 A, 3-phase	
AC charging cable with Type 2 Vehicle Connector and straight cable with open cable end	1409319	1	1409320	1
AC charging cable with Type 2 Vehicle Connector and spiraled cable with open cable end	1405195	1	1405197	1
	Ordering data		Ordering data	
Description	Order No.	Pcs. / Pkt.	Order No.	Pcs. / Pkt.
	32 A, 1-phase		32 A, 3-phase	
	1405198	1	1405199	1
	1622042	1	1410088	1

AC charging cables type 2 with open cable end

AC charging cables Type 2 with open cable end are installed in charging stations and wall boxes in European infrastructure. They are used to charge electric vehicles with single or three-phase alternating current.

Notes:
Further cable types and lengths are available on request.
Color variants for housing, cables, and customer-specific labels available on request.
All Vehicle Connectors are supplied with a protective cap.



AC Type 2 Vehicle Connector, with metric, red cable



AC Type 2 Vehicle Connector, with metric, red cable



Technical data	
20 A, 1-phase	
Rated current	20 A
Number of phases	1
Rated voltage	250 V AC
Standards	IEC 62196-2
Charging mode	Mode 3
Resistor coding	680 Ω (between PE and PP)
Ambient temperature (operation)	-30 °C ... 50 °C
Number of power contacts	3 (L1, N, PE)
Insertion/withdrawal cycles	> 10000
Insertion/withdrawal force	< 100 N
Type of protection (when plugged in)	IP44
Degree of protection (with protective cap)	IP44
Cable data	
Cable type	Straight
Cable length	4 m
Cable diameter	10.5 mm ±0.5 mm
Cable structure	3 x 2.5 mm ² + 1 x 0.5 mm ²
Sheath color	Red

Rated current	20 A
Number of phases	1
Rated voltage	250 V AC
Standards	IEC 62196-2
Charging mode	Mode 3
Resistor coding	680 Ω (between PE and PP)
Ambient temperature (operation)	-30 °C ... 50 °C
Number of power contacts	3 (L1, N, PE)
Insertion/withdrawal cycles	> 10000
Insertion/withdrawal force	< 100 N
Type of protection (when plugged in)	IP44
Degree of protection (with protective cap)	IP44
Cable data	
Cable type	Straight
Cable length	4 m
Cable diameter	10.5 mm ±0.5 mm
Cable structure	3 x 2.5 mm ² + 1 x 0.5 mm ²
Sheath color	Red



Technical data	
20 A, 1-phase	
Rated current	20 A
Number of phases	1
Rated voltage	250 V AC
Standards	IEC 62196-2
Charging mode	Mode 3
Resistor coding	680 Ω (between PE and PP)
Ambient temperature (operation)	-30 °C ... 50 °C
Number of power contacts	3 (L1, N, PE)
Insertion/withdrawal cycles	> 10000
Insertion/withdrawal force	< 100 N
Type of protection (when plugged in)	IP44
Degree of protection (with protective cap)	IP44
Cable data	
Cable type	Spiraled
Cable length	4 m
Cable diameter	10.5 mm ±0.5 mm
Cable structure	3 x 2.5 mm ² + 1 x 0.5 mm ²
Sheath color	Red

Rated current	20 A
Number of phases	1
Rated voltage	250 V AC
Standards	IEC 62196-2
Charging mode	Mode 3
Resistor coding	680 Ω (between PE and PP)
Ambient temperature (operation)	-30 °C ... 50 °C
Number of power contacts	3 (L1, N, PE)
Insertion/withdrawal cycles	> 10000
Insertion/withdrawal force	< 100 N
Type of protection (when plugged in)	IP44
Degree of protection (with protective cap)	IP44
Cable data	
Cable type	Spiraled
Cable length	4 m
Cable diameter	10.5 mm ±0.5 mm
Cable structure	3 x 2.5 mm ² + 1 x 0.5 mm ²
Sheath color	Red

Ordering data		
Type	Order No.	Pcs. / Pkt.
EV-T2M3C-1AC20A-4,0M2,5ESRD00	1408274	1

Description	AC charging cable with Type 2 Vehicle Connector and straight cable with open cable end
Description	AC charging cable with Type 2 Vehicle Connector and spiraled cable with open cable end

Ordering data		
Type	Order No.	Pcs. / Pkt.
EV-T2M3C-1AC20A-4,0M2,5EHRD00	1405194	1

Plug-in charging systems for E-Mobility

Mobile AC charging cables

Mobile AC charging cables

Type 1 to Type 2 (mode 3)

The mobile AC charging cables enable electric vehicles to be charged with alternating current at European charging stations or wall boxes at home and while on the move. They can easily be stored inside the vehicle.

Notes:
Further cable types and lengths are available on request.
Color variants for housing, cables, and customer-specific labels available on request.
All Vehicle Connectors and Infrastructure Plugs are supplied with a protective cap.



Type 1 Vehicle Connector with Type 2 Infrastructure Plug



Type 1 Vehicle Connector with Type 2 Infrastructure Plug

	Technical data		Technical data	
	20 A, 1-phase	32 A, 1-phase	20 A, 1-phase	
Rated current	20 A	32 A	20 A	
Number of phases	1	1	1	
Rated voltage	250 V AC	250 V AC	250 V AC	
Standards	IEC 62196-2	IEC 62196-2	IEC 62196-2	
Charging mode	Mode 3	Mode 3	Mode 3	
Ambient temperature (operation)	-30 °C ... 50 °C	-30 °C ... 50 °C	-30 °C ... 50 °C	
Number of power contacts	3 (L1, N, PE)	3 (L1, N, PE)	3 (L1, N, PE)	
Insertion/withdrawal cycles	> 10000	> 10000	> 10000	
Insertion/withdrawal force	< 100 N	< 100 N	< 100 N	
Type of protection (when plugged in)	IP44	IP44	IP44	
Degree of protection (with protective cap)	IP44	IP44	IP44	
Cable data				
Cable type	Straight	Straight	Spiraled	
Cable length	4 m	4 m	4 m	
Cable diameter	10.5 mm ±0.5 mm	13.9 mm ±0.5 mm	10.5 mm ±0.5 mm	
Cable structure	3 x 2.5 mm ² + 1 x 0.5 mm ²	3 x 6 mm ² + 1 x 0.5 mm ²	3 x 2.5 mm ² + 1 x 0.5 mm ²	
Sheath color	Black	Black	Black	
	Ordering data		Ordering data	
Description	Order No.	Pcs. / Pkt.	Order No.	Pcs. / Pkt.
	20 A, 1-phase		32 A, 1-phase	
AC charging cable with Type 1 Vehicle Connector, straight cable, and Type 2 Infrastructure Plug	1621481	1	1410090	1
AC charging cable with Type 1 Vehicle Connector, spiraled cable, and Type 2 Infrastructure Plug			1621669	1

**Mobile AC charging cables
Type 2 (mode 3)**

The mobile AC charging cables enable electric vehicles to be charged with alternating current at European charging stations or wall boxes at home and while on the move. They can easily be stored inside the vehicle.



**Type 2 Vehicle Connector
with Type 2 Infrastructure Plug**



**Type 2 Vehicle Connector
with Type 2 Infrastructure Plug**

Notes:
Further cable types and lengths are available on request.
Color variants for housing, cables, and customer-specific labels available on request.
All Vehicle Connectors and Infrastructure Plugs are supplied with a protective cap.



Rated current	20 A
Number of phases	1
Rated voltage	250 V AC
Standards	IEC 62196-2
Charging mode	Mode 3
Ambient temperature (operation)	-30 °C ... 50 °C
Number of power contacts	3 (L1, N, PE)
Insertion/withdrawal cycles	> 10000
Insertion/withdrawal force	< 100 N
Type of protection (when plugged in)	IP44
Degree of protection (with protective cap)	IP44
Cable data	
Cable length	4 m
Cable diameter	10.5 mm ±0.5 mm
Cable structure	3 x 2.5 mm ² + 1 x 0.5 mm ²

Technical data	
20 A, 1-phase	20 A, 3-phase
Rated current	20 A
Number of phases	3
Rated voltage	480 V AC
Standards	IEC 62196-2
Charging mode	Mode 3
Ambient temperature (operation)	-30 °C ... 50 °C
Number of power contacts	5 (L1, L2, L3, N, PE)
Insertion/withdrawal cycles	> 10000
Insertion/withdrawal force	< 100 N
Type of protection (when plugged in)	IP44
Degree of protection (with protective cap)	IP44
Cable data	
Cable length	4 m
Cable diameter	13 mm ±0.5 mm
Cable structure	5 x 2.5 mm ² + 1 x 0.5 mm ²

Technical data	
32 A, 1-phase	32 A, 3-phase
Rated current	32 A
Number of phases	3
Rated voltage	480 V AC
Standards	IEC 62196-2
Charging mode	Mode 3
Ambient temperature (operation)	-30 °C ... 50 °C
Number of power contacts	5 (L1, L2, L3, N, PE)
Insertion/withdrawal cycles	> 10000
Insertion/withdrawal force	< 100 N
Type of protection (when plugged in)	IP44
Degree of protection (with protective cap)	IP44
Cable data	
Cable length	4 m
Cable diameter	17 mm ±0.5 mm
Cable structure	5 x 6 mm ² + 1 x 0.5 mm ²

Description
AC charging cable with Type 2 Vehicle Connector, black , straight cable, and Type 2 Infrastructure Plug
AC charging cable with Type 2 Vehicle Connector, red , straight cable, and Type 2 Infrastructure Plug
AC charging cable with Type 2 Vehicle Connector, black , spiraled cable, and Type 2 Infrastructure Plug
Outer sheath color: black AC charging cable with Type 2 Vehicle Connector, red , spiraled cable, and Type 2 Infrastructure Plug

Ordering data			
Order No.	Pcs. / Pkt.	Order No.	Pcs. / Pkt.
20 A, 1-phase		20 A, 3-phase	
1405193	1	1404877	1
1404876	1		
1405192	1	1404567	1
1404563	1		

Ordering data			
Order No.	Pcs. / Pkt.	Order No.	Pcs. / Pkt.
32 A, 1-phase		32 A, 3-phase	
1404568	1	1404569	1
		1622495	1

Plug-in charging systems for E-Mobility

Mobile AC charging cables

Mobile AC charging cables GB/T (mode 3)

The mobile GB/T charging cables enable electric vehicles to be charged with alternating current at Chinese charging stations or wall boxes at home and while on the move.

They can easily be stored inside the vehicle.



**GB/T Vehicle Connector
with GB/T Infrastructure Plug**



**GB/T Vehicle Connector
with GB/T Infrastructure Plug**

Notes:
Further cable types and lengths are available on request.
Color variants for housing, cables, and customer-specific labels available on request.
All Vehicle Connectors and Infrastructure Plugs are supplied with a protective cap.

	Technical data		Technical data	
	16 A, 1-phase		32 A, 1-phase	32 A, 3-phase
Rated current	16 A		32 A	32 A
Number of phases	1		1	3
Rated voltage	250 V		250 V	440 V
Standards	GB/T 20234.2		GB/T 20234.2	GB/T 20234.2
Charging mode	Mode 3		Mode 3	Mode 3
Resistor coding	680 Ω (between PE and CC)		220 Ω (between PE and CC)	220 Ω (between PE and CC)
Ambient temperature (operation)	-30 °C ... 50 °C		-30 °C ... 50 °C	-30 °C ... 50 °C
Number of power contacts	3 (L1, N, PE)		3 (L1, N, PE)	5 (L, NC1, NC2, N, PE)
Insertion/withdrawal cycles	> 10000		> 10000	> 10000
Insertion/withdrawal force	< 100 N		< 100 N	< 100 N
Type of protection (when plugged in)	IP55		IP55	IP55
Degree of protection (with protective cap)	IP54		IP54	IP54
Cable data				
Cable type	Straight		Straight	Straight
Cable length	5 m		5 m	5 m
Cable diameter	10.5 mm		13.9 mm	17.1 mm
Cable structure	3 x 2.5 mm ² + 1 x 0.5 mm ²		3 x 6.0 mm ² + 1 x 0.5 mm ²	5 x 6.0 mm ² + 1 x 0.5 mm ²
Sheath color	Orange		Orange	Orange
Ordering data				
Description	Order No.	Pcs. / Pkt.	Order No.	Pcs. / Pkt.
	16 A, 1-phase		32 A, 1-phase	32 A, 3-phase
AC charging cable with GB/T Vehicle Connector and GB/T Infrastructure Plug	1408161	1	1408163	1
			1408165	1

Mobile AC charging cables type 1 and type 2 (mode 2)

The mobile AC charging cables with In-Cable Control and Protection Device (IC-CPD) enable electric vehicles to be charged with alternating current at a normal, European socket at home and while on the move. The components for standardized communication with the vehicle as well as the safety equipment are integrated in the IC-CPD.



**Type 1 Vehicle Connector
with IC-CPD and SCHUKO connector**



**Type 2 Vehicle Connector
with IC-CPD and SCHUKO connector**

Notes:
Color variants for housing, cables, and customer-specific labels available on request.
All Vehicle Connectors are supplied with a protective cap.

Rated current	6 A ... 13 A
Number of phases	1
Rated voltage	200 V AC ... 250 V AC
Frequency	50 Hz
Charging power	1.4 kW ... 3 kW
Standards	IEC 61851-1
Charging mode	Mode 2
Ambient temperature (operation)	-30 °C ... 50 °C
Tripping characteristics / residual current	Type A/30 mA
Infrastructure plug	SCHUKO (CEE 7/7, type AF)
Temperature sensor (infrastructure plug)	Available
Degree of protection (IC-CPD)	IP67
Type of protection (when plugged in)	IP44
Degree of protection (with protective cap)	IP44
Cable data	
Cable type	Straight
Cable length	4 m
Cable diameter	10.5 mm ±0.5 mm
Cable structure	3 x 2.5 mm ² + 2 x 0.5 mm ²
Sheath color	Red

Technical data

13 A, 1-phase	
Rated current	6 A ... 13 A
Number of phases	1
Rated voltage	200 V AC ... 250 V AC
Frequency	50 Hz
Charging power	1.4 kW ... 3 kW
Standards	IEC 61851-1
Charging mode	Mode 2
Ambient temperature (operation)	-30 °C ... 50 °C
Tripping characteristics / residual current	Type A/30 mA
Infrastructure plug	SCHUKO (CEE 7/7, type AF)
Temperature sensor (infrastructure plug)	Available
Degree of protection (IC-CPD)	IP67
Type of protection (when plugged in)	IP44
Degree of protection (with protective cap)	IP44
Cable data	
Cable type	Straight
Cable length	4 m
Cable diameter	10.5 mm ±0.5 mm
Cable structure	3 x 2.5 mm ² + 2 x 0.5 mm ²
Sheath color	Red

Technical data

13 A, 1-phase	
Rated current	6 A ... 13 A
Number of phases	1
Rated voltage	200 V AC ... 250 V AC
Frequency	50 Hz
Charging power	1.4 kW ... 3 kW
Standards	IEC 61851-1
Charging mode	Mode 2
Ambient temperature (operation)	-30 °C ... 50 °C
Tripping characteristics / residual current	Type A/30 mA
Infrastructure plug	SCHUKO (CEE 7/7, type AF)
Temperature sensor (infrastructure plug)	Available
Degree of protection (IC-CPD)	IP67
Type of protection (when plugged in)	IP44
Degree of protection (with protective cap)	IP44
Cable data	
Cable type	Straight
Cable length	4 m
Cable diameter	10.5 mm ±0.5 mm
Cable structure	3 x 2.5 mm ² + 2 x 0.5 mm ²
Sheath color	Red

Description
AC charging cable with Vehicle Connector and IC-CPD control unit

Ordering data

Type	Order No.	Pcs. / Pkt.
EV-ICCPD-T1C-EU-S-13A1-A-GEN2	1621797	1

Ordering data

Type	Order No.	Pcs. / Pkt.
EV-ICCPD-T2C-EU-S-13A1-A	1621516	1

Wall bracket, for mobile AC charging cables with Vehicle Connector and IC-CPD
--

Accessories

EV-ICCPD-WB	1622474	1
-------------	---------	---

Accessories

EV-ICCPD-WB	1622474	1
-------------	---------	---



Wall bracket

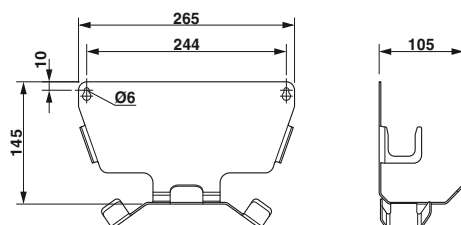

Infrastructure Socket Outlets

AC Infrastructure Socket Outlets GB/T and Type 2

Single or three-phase charging is possible with the standardized Infrastructure Socket Outlets for charging stations or wall charging stations. Up to 22 kW of power can be transmitted when a mobile AC charging cable is connected.

Notes:
 All Infrastructure Socket Outlets can be mounted on the housing panel from both the front and the rear (see below).
 As an option, the AC Infrastructure Socket Outlet Type 2 can be secured with a hinged cover or a panel mounting frame for both front and rear panel mounting.



Infrastructure Socket Outlet GB/T with actuator



Infrastructure Socket Outlet GB/T without actuator

	Technical data		Technical data	
	32 A, 1-phase	32 A, 3-phase	32 A, 1-phase	32 A, 3-phase
Rated current	32 A	32 A	32 A	32 A
Number of phases	1	3	-	3
Rated voltage	250 V AC	440 V AC	250 V AC	440 V AC
Standards	GB/T 20234.2	GB/T 20234.2	GB/T 20234.2	GB/T 20234.2
Charging mode	Mode 3	Mode 3	Mode 3	Mode 3
Ambient temperature (operation)	-30 °C ... 50 °C	-30 °C ... 50 °C	-30 °C ... 50 °C	-30 °C ... 50 °C
Number of power contacts	3 (L1, N, PE)	5 (L1, L2, L3, N, PE)	3 (L1, N, PE)	5 (L1, L2, L3, N, PE)
Insertion/withdrawal cycles	> 10000	> 10000	> 10000	> 10000
Type of protection (when plugged in)	IP55	IP55	IP55	IP55
Degree of protection (with hinged cover)	-	-	-	-
Cable data				
Cable type	Single wires	Single wires	Single wires	Single wires
Cable length	0.70 m	0.70 m	0.70 m	0.70 m
Cable structure	3 x 6.0 mm ² + 2 x 0.5 mm ²	5 x 6.0 mm ² + 2 x 0.5 mm ²	3 x 6.0 mm ² + 2 x 0.5 mm ²	5 x 6.0 mm ² + 2 x 0.5 mm ²
Actuator data				
Mechanical emergency release	Available	Available	Available	Available
Lock recognition	Available	Available	Available	Available
Ordering data				
Description	Order No.	Pcs. / Pkt.	Order No.	Pcs. / Pkt.
	32 A, 1-phase		32 A, 3-phase	
AC socket outlet				
With actuator (12 V operating voltage)	1408171	1	1408172	1
With actuator (24 V operating voltage)				
Without actuator				
AC socket outlet accessories				
			1408169	1
				1408170



Infrastructure Socket Outlet Type 2 with actuator



Hinged cover for Infrastructure Socket Outlet Type 2



Panel mounting frame for Infrastructure Socket Outlet Type 2



Technical data		Technical data		Technical data	
20 A, 3-phase		32 A, 3-phase			
20 A	32 A	-		-	
3	3	-		-	
480 V AC	480 V AC	-		-	
IEC 62196-2	IEC 62196-2	IEC 62196-2		IEC 62196-2	
Mode 3	Mode 3	Mode 3		Mode 3	
-30 °C ... 50 °C	-30 °C ... 50 °C	-30 °C ... 50 °C		-30 °C ... 50 °C	
5 (L1, L2, L3, N, PE)	5 (L1, L2, L3, N, PE)	-		-	
> 10000	> 10000	-		-	
IP44	IP44	-		-	
IP54	IP54	IP54		-	
Single wires	Single wires	-		-	
0.70 m	0.70 m	-		-	
5 x 2.5 mm ² + 2 x 0.5 mm ²	5 x 6.0 mm ² + 2 x 0.5 mm ²	-		-	
Available	Available	-		-	
Available	Available	-		-	
Ordering data		Ordering data		Ordering data	
Order No.	Pcs. / Pkt.	Order No.	Pcs. / Pkt.	Order No.	Pcs. / Pkt.
20 A, 3-phase		32 A, 3-phase			
1405213	1	1405214	1		
1405215	1	1405216	1		
		1405217	1	1405218	1

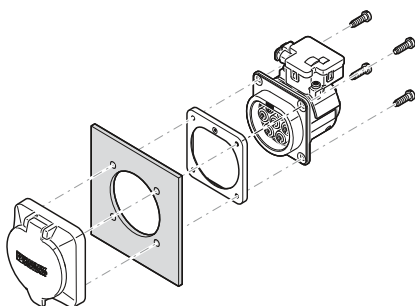

Rear panel mounting

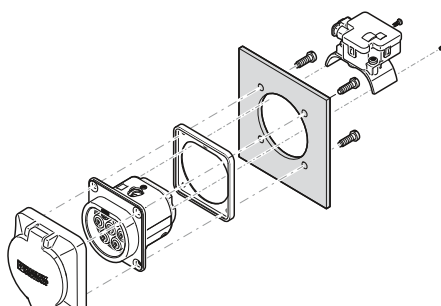

Front mounting

Quality in quantity

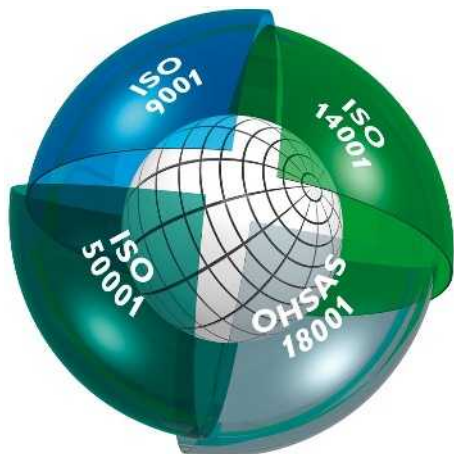

Integrated management system

The aim of the Phoenix Contact integrated management system is to coordinate all the requirements regarding products, processes, and organization.

Statutory and regulatory requirements, as well as those of international standards and our customers, are met and, in some cases, even exceeded in all phases of the product lifecycle.

The Phoenix Contact management system is monitored by internationally recognized independent bodies each year to ensure that quality, environmental protection, energy efficiency, and occupational safety have been integrated in conformance with the relevant requirements. Certification in accordance with international standards ISO 9001, ISO 14001, ISO 50001, and BS OHSAS 18001 is the result of our corporate philosophy of meeting the needs of our customers, staff, and environment as best as possible. They serve as the basis for innovative products with the familiar high Phoenix quality standard, actively practiced environmental protection through efficient production and products that conserve resources, and responsibility in the field of occupational health and safety. It goes without saying that we integrate all further requirements of standards, international approvals or special customer requirements into our company processes.

This system provides a building block for the success of the Phoenix Contact Group and its products and services.

CE marking

CE marking was introduced as an important instrument for the free movement of goods and services within the single European market. By attaching the mark to a product, the manufacturer confirms that it complies with all applicable European Union (EU) directives. EC directives describe the product properties with regard to device safety and avoiding danger. These are legally binding regulations of the European Union (EU). In other words, compliance with the requirements is a **statutory condition for marketing the product within the EU.**

Where applicable, the products that our company currently manufactures fall within the scope of the following directives:

- 2006/95/EC and 2014/35/EU
Electrical equipment designed for use with certain voltage limits (Low-Voltage Directive)
- 2004/108/EC and 2014/30/EU
Electromagnetic compatibility (EMC Directive)
- 2004/22/EC and 2014/32/EU
Measuring instruments
- 2006/42/EC
Safety of machinery (Machinery Directive)
- 94/9/EC and 2014/34/EU
Equipment and protective systems intended for use in potentially explosive areas (ATEX Directive)
- 1999/5/EC
R&TTE Directive and 2014/53/EU
Radio Equipment Directive

The standards upon which the specified directives are based have been part of our standard of development for a long time. This guarantees conformance with European directives. The numbers of the directives indicate their version at the time of publication.

In the event of changes to directives and/or standards, our products will undergo conformity assessment again in good time and a new declaration of conformity will be issued promptly. The current declarations for each product can also be found in our download area.

The EMC Directive occupies a special place among the European directives listed. It defines electromagnetic compatibility as a fundamental property of devices based on mandatory guidelines. European Law therefore acknowledges the electromagnetic compatibility of devices and systems as an important condition for error-free operation of machinery and systems. Phoenix Contact is one of the leading international companies in surge protection, and therefore possesses broad expertise in EMC. This expertise and the experience gained over years of developing and applying industrial interface and communication technology have resulted in our products having an extremely high standard of quality with regard to electromagnetic compatibility. It was with a view to providing other companies with this expertise that our associate company, Phoenix Testlab, was founded. Phoenix Testlab GmbH is an independent, accredited service provider offering EMC testing that conforms to European standards. At Phoenix Testlab, devices are also tested with regard to their electrical safety, mechanical influences, and their behavior in relation to environmental influences. Furthermore, Phoenix Testlab is a “Notified Body” in accordance with EMC Directive 2004/108/EC and according to R&TTE Directive 1999/5/EC for

radio and telecommunications terminal equipment. As a “Telecom Certification Body” (TCB), Phoenix Testlab may also approve these products for markets in the USA, Canada, and Japan.

Standards and regulations

All relevant standards and regulations are used as the basis for the development and maintenance of our products.

International standards are subject to continuous changes as a result of harmonization and new developments. In line with this process, the current version of all standards that are relevant to our products is documented in the product area on our website at www.phoenixcontact.net/products.

Online product information service on the web

Phoenix Contact's product range is growing constantly.

Due to our commitment to product monitoring, all products are subject to improvement.

The Internet is an ideal platform to quickly communicate new product developments and improvements to the market.

You can quickly access the relevant Phoenix Contact website for your region via www.phoenixcontact.com. Here, you will always find the latest overview of products, solutions, and services from Phoenix Contact. This includes technical documents, such as data sheets and user manuals, the latest driver and demo software, plus a means of contacting the appropriate contact person directly.

Connection cross section

IEC 60947-7-1/-2

The connection capacity for connectors and PCB terminal blocks is documented in the technical data. The connection capacity defines the conductor cross section which can be connected for conductors in solid (single and multi-strand) or stranded (fine-strand) versions. Cross section ranges are also specified for the use of ferrules. In addition, ranges where two conductors in solid and stranded versions are to be simultaneously connected are also mentioned.

Phoenix Contact PCB terminal blocks and PCB connectors are designed to allow copper conductors to be connected to them untreated. "Special treatment" or the use of ferrules is not required. "Special

treatment" includes tin-plating the litz wires of a conductor, using cable lugs, bending the eyes, etc. However, it does not include straightening the conductor before inserting it into the terminal block or twisting a stranded conductor in order to consolidate its ends.

If ferrules are nevertheless used to protect stranded conductors against splicing, the connection capacity of the stranded conductor is generally reduced by one level. Conductors must not be soldered ("soldering all litz wires of a conductor together").

It is always recommended that you use Phoenix Contact CRIMPFOX crimping tools to crimp ferrules.

Structure and dimensions of connecting cables

Cross section [mm ²]	Single-strand		Multi-strand		Fine-strand		American Wire Gauge [AWG]						
	Diameter max. dimension	Number of wires	Diameter max. dimension	Number of wires (minimum number)	Diameter max. dimension	Number of wires (guide value)	Gauge No.	Solid wires*			Stranded wires*		
								AWG	[Ø mm]	[circ. mils]	[mm ²]	[Ø mm]	[circ. mils]
0.2	0.5	1	-	-	-	-	24	0.51	404	0.21	-	-	-
0.5	0.9	1	1.1	7	1.1	16	20	0.81	1022	0.52	0.97	1111	0.56
0.75	1.0	1	1.2	7	1.3	24	18	1.02	1620	0.82	1.16	1600	0.82
1	1.2	1	1.4	7	1.5	32	(17)	1.15	2050	1.04	-	-	-
-	-	-	-	-	-	-	16	1.29	2580	1.31	1.50	2580	1.32
1.5	1.5	1	1.7	7	1.8	30	(15)	1.45	3260	1.65	-	-	-
-	-	-	-	-	-	-	14	1.63	4110	2.08	1.85	4100	2.09
2.5	1.9	1	2.2	7	2.3	50	(13)	1.83	5180	2.63	-	-	-
-	-	-	-	-	-	-	12	2.05	6530	3.31	2.41	6500	3.32
4	2.4	1	2.7	7	2.9	56	(11)	2.30	8230	4.17	-	-	-
-	-	-	-	-	-	-	10	2.59	10380	5.26	2.95	10530	5.37
6	2.9	1	3.3	7	3.9	84	(9)	2.91	13100	6.63	-	-	-
-	-	-	-	-	-	-	8	3.26	16510	8.37	3.73	16625	8.48
10	3.7	1	4.2	7	5.1	80	(7)	3.67	20800	10.56	4.15	20820	10.55
-	-	-	-	-	-	-	6	4.12	26240	13.30	4.67	26250	13.39
16	4.6	1	5.3	7	6.3	126	(5)	4.62	33100	16.77	5.24	33100	16.77
-	-	-	-	-	-	-	4	5.19	41740	21.15	5.90	41650	21.24
25	-	-	6.6	7	7.8	196	3	5.83	52600	26.67	6.61	52630	26.67
35	-	-	7.9	7	9.2	276	2	6.54	66360	33.62	7.42	66150	33.74
-	-	-	-	-	-	-	1	7.35	83690	42.41	8.33	83706	42.69
50	-	-	9.1	19	11	396	1/0	8.25	105600	53.51	9.35	104640	53.36
70	-	-	11	19	13.1	360	2/0	9.27	133100	67.44	10.52	132300	67.47

Tightening torque of terminal block screws

DIN EN 60947-1

Table 4 of the standard specifies the tightening torque to demonstrate the mechanical strength of screw connections/screw terminal blocks.

These torques are sufficient for connecting conductors with Phoenix Contact terminal blocks.

The table opposite lists recommended tightening torques which differ from those in this standard and which will ensure gas-tight connections with long-term stability.

Phoenix Contact torque screwdrivers can be set to the corresponding torques.

Extract from DIN EN 60947-1/EN 60947-1, Table 4

The torque according to IEC/EN and the recommended tightening torque for Phoenix Contact terminal blocks are specified.

Head screw with slot	
Thread	Torque
	[Nm]
M1.6	0.1*
M2.0	0.2*
M2.5 (M2.6)	0.4*
M3	0.5*
M4	1.2*
M4.5	1.8*
M5	2.0*
M6	2.5*
M8	3.5*
M10	4.0* / 10**
M12	14**
M14	19**
M16	25**
M20	36**
M24	50**

* Valid for nuts and screws tightened with screwdrivers.

**Valid for nuts and screws that can be tightened with tools other than screwdrivers.

Note:

Subject to changes that serve the purpose of technical progress.

Current carrying capacity

Standard IEC 60947-7-1/EN 60947-7-1/DIN VDE 0611-1 specifies the test currents for the individual conductor cross sections listed in the adjacent table. The corresponding currents are listed with the connection data for the individual terminal blocks. The type tests of terminal blocks are based on this data.

Test currents according to IEC 60947-7-1/EN 60947-7-1, Table 5

Rated cross section	[mm ²]	0.2	0.5	0.75	1.0	1.5	2.5	4	6	10	16
Test current	[A]	4	6	9	13.5	17.5	24	32	41	57	76

Rated cross section	[mm ²]	25	35	50	70	95	120	150	185	240	300
Test current	[A]	101	125	150	192	232	269	309	353	415	520

Color designations

Color	Code
White	WH
Red	RD
Blue	BU
Green	GN
Yellow	YE
Gray	GY
Brown	BN
Orange	OG
Black	BK
Turquoise	TQ
Ivory	IV
Beige	BE
Olive	OL

EMC: Class A product:

In accordance with statutory regulations, our products are indicated with this footnote if they are intended for use in industrial environments. This means that the permitted limit values for residential applications may be exceeded in the event of conducted and emitted disturbance variables. In such cases, the operator may have to take additional safety measures in order to ensure electromagnetic compatibility in residential applications.

Shock protection

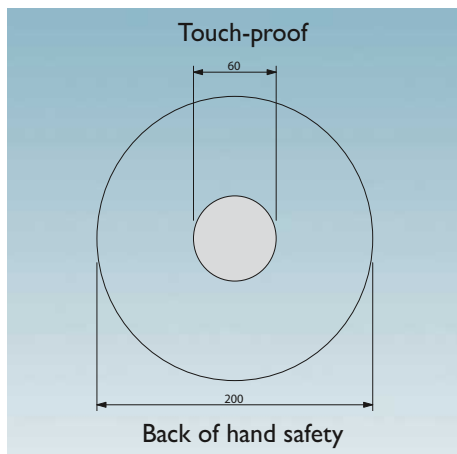

Example: pressure actuation



Finger safety

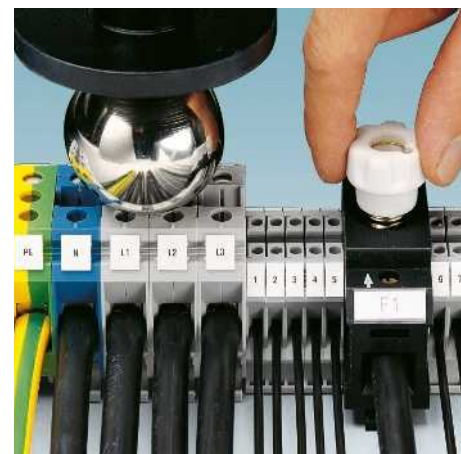

Back of hand safety

The accident prevention regulations BGV A 2 issued by the German employer's liability insurance association for precision mechanics and electrical engineering apply to the operators of electrical systems and are aimed at the prevention of electrical accidents by means of special safety requirements.

These regulations contain specifications regarding the safety distances for work, operation, and occasional handling in the proximity of "live parts" in low-voltage systems up to 1000 V ~ or 1500 V –.

- Work with live parts is only permitted once they have been de-energized.

Operational activities are only permitted in the vicinity of live parts if these parts are de-energized or are protected against direct contact (§ 6). The following safety measures apply when working in the vicinity of live parts:

- Provision of the de-energized state for the duration of the work

- Ensure shock protection is in place in the form of covers or barriers during the work

- Assurance that proximity limits will not be violated (§ 7)

The term "occasional handling" has been introduced for the operation of elements such as pushbuttons, rocker arms or rotary buttons in the proximity of live parts.

According to VDE 0105-1, this is covered by "operation with partial protection against direct contact".

Detailed specifications for "occasional handling" can be found in DIN VDE 0106-100. This specifies to what degree live parts in the proximity of operating elements are to be protected against contact. The basis for this is the definition of a "protection area for occasional handling"; this is the area into which the user must reach in order to handle the machine.

The most important thing is that an area formed by an even envelope curve 30 mm in radius must surround the live parts. This area must be **touch-proof**, i.e., the live parts of the electrical device must not be within reach of the VDE test finger according to IEC 60529/DIN VDE 0470-1 (test finger).

Back of hand safety is specified for the "rest of the area" up to 100 mm around the operating element. **Back of hand safety** means that when a force of 50 N is applied to a ball with a diameter of 50 mm, this does not come into contact with the live parts of the equipment. No special measures for ensuring contact safety are stipulated outside this area.

Note: systems and equipment that are operated with SELV up to 25 V ~ or 60 V – are considered to be protected against "direct contact".

According to § 5, Subsection 4 of the BGV A 2 regulations, there is no need to test the condition of the system prior to initial start-up if the company has confirmation from the manufacturer or installer that the electrical systems and equipment conform to BGV A 2. The confirmation required relates to systems and equipment that have been installed and are ready for operation and can only be issued by the installer or installation company. The manufacturer of the electrical equipment can only issue a confirmation that products have been produced in accordance with the relevant electro-technical DIN VDE regulations stipulated in BGV A 2. The installer must bear this in mind when selecting the equipment to be used.

In the field of connection technology, Phoenix Contact offers a wide range of products which are touch-proof or can be protected against contact by means of covers. Depending on the conditions, all of this



must be taken into account when selecting the individual types of terminal blocks and accessories.

Degrees of protection according to DIN EN 60529





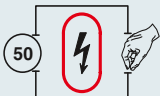

Definition:

IP (Ingress Protection) protection according to DIN EN 60529 is defined by two digits (e.g., IP54), the meaning of which is explained in the following tables.

Degree of protection against access to dangerous parts and against solid foreign objects

First digit	Short description	Example	Definition
0	Not protected		
1	Protected against solid foreign objects		Protected against touching dangerous parts with the back of the hand. Protection against ingress of solid foreign objects with $\varnothing > 50$ mm.
2	Protected against solid foreign objects with $\varnothing 12.5$ mm or more		Protected against touching dangerous parts with a finger. Protection against ingress of solid foreign objects with $\varnothing > 12.5$ mm.
3	Protected against solid foreign objects with $\varnothing 2.5$ mm or more		Protected against touching dangerous parts with a tool. Protection against ingress of solid foreign objects with $\varnothing > 2.5$ mm.
4	Protected against solid foreign objects with $\varnothing 1$ mm or more		Protected against touching dangerous parts with a wire. Protection against ingress of solid foreign objects with $\varnothing > 1$ mm.
5	Protected against dust		Protected against touching dangerous parts with a wire. The ingress of dust is not completely prevented, but dust may not enter in such an amount that the satisfactory operation of the device or its safety is impaired.
6	Dust-proof		Protected against touching dangerous parts with a wire. No ingress of dust.

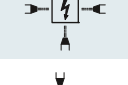
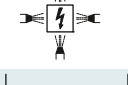
Degree of protection against water

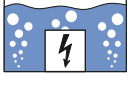
Second digit	Short description	Example	Definition
0	Not protected		
1	Protected against dripping water		Vertically falling drops shall have no effect.
2	Protected against dripping water if the housing is inclined at an angle of up to 15°		Vertically falling drops shall have no effect if the housing is inclined at an angle of up to 15° either side of the perpendicular.
3	Protected against spray water		Water that is sprayed at an angle of up to 60° either side of the perpendicular shall have no harmful effect.
4	Protected against splash water		Water that splashes against the housing from any direction shall have no harmful effect.
5	Protected against jet water		Water that is directed as a jet against the housing from every direction shall have no harmful effect.
6	Protected against powerful jet water		Water that is directed as a strong jet against the housing from every direction shall have no harmful effect.
7	Protected against the effect of temporary submersion in water		Water may not penetrate in a harmful quantity when the housing is temporarily submerged in water under standard pressure and time conditions.
8	Protected against the effect of continuous submersion in water		Water may not penetrate in a harmful quantity when the housing is submerged in water continuously under conditions to be agreed between the manufacturer and user.
9K	Protected against water during high-pressure and jet-stream cleaning		Water that is directed against the housing under extremely high pressure from every direction shall have no harmful effect. (Example: IP69K according to DIN 40050 Part 9)

For safety reasons, electrical equipment must be protected against external influences. This is the job of the housing, which protects electrical equipment against contact, ingress of solid objects, dust, and moisture.

The following table contains possible combinations of degrees of protection according to DIN EN 60529 which can be practically applied to housing.

		Protection against water										
		No protection	Protection against vertically falling dripping water	Protection against dripping water if the housing is inclined at an angle of up to 15°	Protection against spray water from all directions, even when inclined at an angle of up to 60°	Protection against splash water from all directions	Protection against jet water from all directions	Protection against powerful jet water from all directions	Protection against temporary submersion	Protection against the effects of continuous submersion in water	Protected against water during high-pressure and jet-stream cleaning (DIN 40050-9)	
Shock protection	Foreign object protection	IP0x	IPx0	IPx1	IPx2	IPx3	IPx4	IPx5	IPx6	IPx7	IPx8	IPx9K
No shock protection	No protection against solid foreign objects	IP0x	IP00									
Back of hand safety	Protection against solid foreign objects > 50 mm Ø	IP1x	IP10	IP11	IP12							
Touch-proof	Protection against solid foreign objects > 12.5 mm Ø	IP2x	IP20	IP21	IP22	IP23						
Protection against touching with tools, wires, etc. > 2.5 mm Ø	Protection against solid foreign objects > 2.5 mm Ø	IP3x	IP30	IP31	IP32	IP33						
Protection against touching with tools, wires, etc. > 1 mm Ø	Protection against solid foreign objects > 1.5 mm Ø	IP4x	IP40	IP41	IP42	IP43	IP44					
Protection against touching with tools, wires, etc. > 1 mm Ø	Protection against harmful dust accumulations inside the device	IP5x	IP50				IP54	IP55				
Protection against touching with tools, wires, etc. > 1 mm Ø	No ingress of dust	IP6x	IP60					IP65	IP66	IP67	IP68	IP69K

Example: DUPLICON power distribution with IP67 protection according to DIN EN 60529

Dust-proof (IP6x)

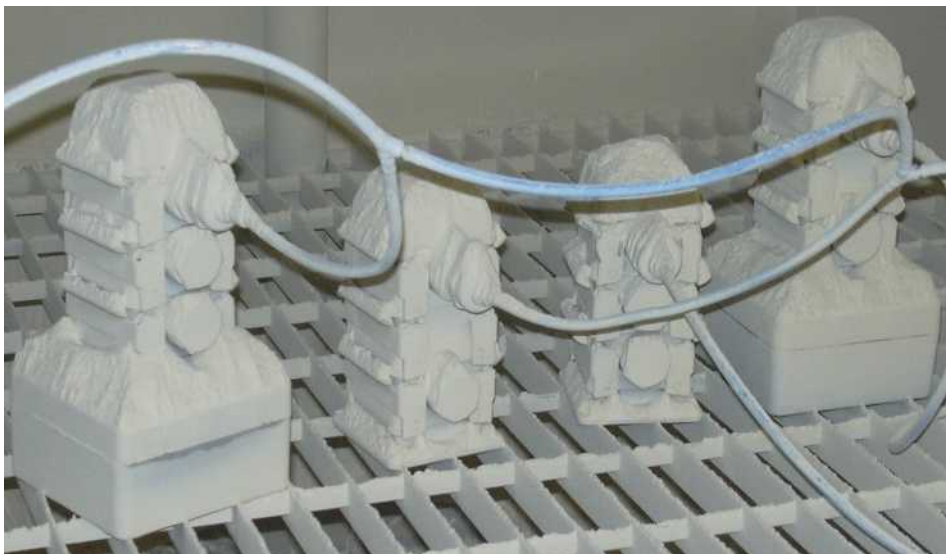

Photo shows DUPLICON test sample during the IP6x dust test

Protected against temporary submersion (IPx7)



Quality features of insulation material

Our insulating housings are made from various thermoplastic materials. Depending on the application, the best-suited material is selected based on its electrical and mechanical properties.

All plastics used by Phoenix Contact are RoHS-compliant.

All plastics used at Phoenix Contact have been listed with UL (Underwriters Laboratories Inc.) in the USA.

Behavior of plastics under the influence of temperature (operating temperatures)

All plastics undergo thermal aging when they are subjected to heat over long periods. This process causes changes in the mechanical and electrical properties of the material. External influences, e.g., radiation, additional mechanical, chemical or electrical stresses, amplify this effect. All characteristics included in the table have been determined based on samples which provides a good means of drawing comparisons between different materials. However, applying these characteristics to an evaluation of molded plastic parts is only possible to a limited extent, and can only give the designer a rough guide when it comes to selecting a plastic material. This catalog uses RTI Elec. according to UL 746B as an assessment criterion for temperature resistance.

Insulation materials

Polyamide: PA and PA-GF

Polyamide has excellent electrical, mechanical, and chemical properties even at high operating temperatures. Brief peak temperatures of up to approximately 200°C are permitted as a result of heat aging stabilization. The absorption of water makes the plastic flexible and resistant to breakage, even at low temperatures.

Fiber-reinforced polyamides feature greater rigidity and hardness as well as operating temperatures higher than those of non-reinforced materials.

Polyamide for high-temperature applications: PA HT and PA-GF HT

Special high-temperature-resistant types of polyamide are used in non-reinforced or fiberglass-reinforced versions for reflow applications. These high-temperature polyamides combine the excellent electrical properties of polyamide and the

requirements of the reflow soldering process for temperature resistance.

Liquid crystal polymers: LCP GF

LCP combines high temperature stability with excellent dimensional stability and creepage resistance for products used in reflow processes. LCP has exceptional mechanical properties across a wide temperature range and a very low thermal expansion.

Polyester: PBT and PBT-GF

We use thermoplastic polyester in non-reinforced and fiberglass-reinforced versions for special applications which require increased dimensional and form stability.

In addition to the high operating temperature, the material is characterized by excellent mechanical stability, hardness, and excellent notched impact strength. PBT does not absorb moisture from its surroundings. PBT is therefore particularly suitable for strips, for example, which are soldered onto PCBs.

Polycarbonate: PC

Polycarbonate combines many advantages such as rigidity, impact strength, transparency, dimensional stability, good insulation properties, and resistance to heat.

The amorphous material only absorbs moisture to a very limited degree, and is used for items such as large, rigid electronic component housing.

In its transparent form, polycarbonate is particularly suitable for use as a material for cover profiles or marking materials.

Acrylonitrile butadiene styrene: ABS

We use ABS for products which must have good impact and notched impact properties in addition to high mechanical stability and rigidity. The products are also characterized by their special surface quality and hardness.

ABS is suitable for coating metal surfaces, e.g., nickel.

Polyvinyl chloride: PVC

While most thermoplastic materials are processed with injection molding using ready-to-use molding and extrusion material, PVC is processed as a powder in the extruder. This is why it is used in our profile products. PVC is also self-extinguishing without flame protection and

has high mechanical strength but is notch-sensitive.

Polyoxymethylene: POM

Polyoxymethylene is a technical material that combines high rigidity with mechanical stability, excellent elastic properties, high tenacity, dimensional accuracy, and exceptional sliding friction behavior.

Polyethylene: PE

Polyethylene is characterized by excellent chemical resistance and electrical insulation properties. PE is thermoplastic and can therefore be processed using almost all procedures. Furthermore, PE has excellent tenacity even at low temperatures and a good elongation at break.

Polypropylene: PP

PP has higher rigidity, hardness, and stability and is more heat-resistant than PE. PP is not as tough at low temperatures, however.

Thermoplastic polyurethane: TPU and TPU-GF

TPU is characterized by excellent electrical properties, a good surface feel, a high degree of flexibility over a wide temperature range, and high resistance to wear. Thermoplastic polyurethanes are also elastic and low-temperature impact resistant.

In contrast to non-reinforced materials, fiberglass-reinforced TPU is characterized by high rigidity and hardness.

Cross-linked ethylene-propylene-diene polymer/polypropylene: EPDM-PP

EPDM-PP is a polymer blend of PP and cross-linked EPDM. EPDM-PP is a rubber-like material which can be processed using thermoplastic procedures. EPDM-PP combines high temperature resistance, a low compression set, and excellent resistance to abrasion and chemicals.

Acrylonitrile butadiene styrene rubber: NBR

NBR is a rubber with excellent resistance to aging. It also features excellent resistance to abrasion and low plastic flow. Its elasticity is lower than other rubbers.

Fluorinated rubber: FPM

FPM rubbers are characterized by very high temperature resistance, but behave less favorably at low temperatures than other rubbers.

Chlorine-butadiene rubber: CR

CR rubber stands out against other rubbers with its excellent resistance to weather and ozone.

Properties	Standard	Unit	PA	PA GF	PA HT	PA GF HT	PBT	PBT GF	LCP GF	PC	ABS	PVC	POM	PP	PE
RTI Elec ¹⁾	UL 746B	°C	≥ 105	≥ 105	≥ 105	≥ 105	≥ 105	≥ 105	≥ 130	≥ 105	≥ 80	≥ 50	≥ 105	65	50
Minimum temperature for use (without mechanical load)		°C	-40	-40	-40	-40	-40	-40	-40	-40	-40	-15	-40	-40	-40
Dielectric strength	IEC 60243-1/ DIN VDE 0303-21	kV/cm	600	400		> 200	400	400		> 300	850		850		
Resistance to creepage CTI...	IEC 60112/ DIN VDE 0303-1		600	400	≥ 250	225	600	225	175	175	600	600	600		
Resistance to creepage CTI...M	IEC 60112/ DIN VDE 0303-1		550	250			600	225		175	600	600	600		
Inflammability class	UL 94	HB – V0	V2, V0	HB, V0	V0	V0	V0	V0	V0	V2, V0		V0	HB	HB	HB
Tropical and termite resistance			Good	Good			Good			Good					

¹⁾ Possible at "≥" higher temperatures, but not recommended due to increased aging of plastics and insufficient current carrying capacity.

Properties	Standard	Unit	TPU	TPU GF	EPDM/PP	Properties	Standard	Unit	NBR	FPM	CR
RTI Elec.	UL 746B	°C	50	50	100	Operating temperature		°C	≤ 100	≤ 200	≤ 100
Minimum temperature for use (without mechanical load)		°C	-40	-40	-40	Minimum temperature for use (without mechanical load)		°C	-40	-25	-40
Dielectric strength	IEC 60243-1/ DIN VDE 0303-21	kV/cm	35	35		Dielectric strength	IEC 60243-1/ DIN VDE 0303-21	kV/cm	Not relevant as these are sealing materials		
Resistance to creepage CTI...	IEC 60112/ DIN VDE 0303-1		600	600	600	Resistance to creepage CTI...	IEC 60112/ DIN VDE 0303-1				
Resistance to creepage CTI...M	IEC 60112/ DIN VDE 0303-1		600			Resistance to creepage CTI...M	IEC 60112/ DIN VDE 0303-1				
Inflammability class	UL 94	HB – V0	V2	HB	HB	Inflammability class	UL 94	HB – V0			
Chemical resistance	See table for resistance to chemicals										

Resistance to chemicals

- Not resistant
- 0 Moderately resistant
- + Good resistance

Chemicals	Plastics																	
	Concentration in %	Temperature in °C	PA 66/PA 6	PA 66 GF	PA 46 GF	PC GF	POM	NBR	PP	EPDM	PBT	PUR	PUR irradiated*	PVC-P (soft)	PE-LD	TPU	FPM (Viton)	CR (neoprene)
Acetaldehyde			0	0	0	-	0	-	+	0	0	+	+	+	0	0	-	0
Acetone		20	+	+	+	0	+	-	+	+	0	0	0	-	+	-	-	0
Acetate			+	+	+	0	0	-	+	0	0	+	+	-	-	-	-	-
Acetophenone			+	+	+	0	0	-	+	0	0	+	+	-	-	-	-	-
Aldehyde			0	0	0	-	0	-	-	0	+	+	+	0	-	-	0	0
Formic acid			-	-	0	0	+	-	+	+	0	0	0	-	+	0	0	+
Amines			+	+	+	-	0	-	+	0	+	+	+	+	0	-	-	-
Alcohols			0	0	0	0	+	0	+	+	+	+	+	-	+	+	0	+
Ammonia	10	20	+				+	0	+	+	+	+	+	0	+	0	-	+
Benzaldehyde			0	0	0	-	0	-	-	0		+	+	+	0	0	-	0
Gasoline		20	+	+	+	0	+	0	0	-	+	+	+	-	-	-	+	-
Benzol		50	+	+	+	+	0	-	0	-	0	0	0	-	0	-	0	-
Benzophenone		20	+	+	+	0	0	-	+	0	0	+	+	-	-	-	+	-
Boric acid	100	20	0				0	+		+	+	0	0	0	+	+	+	+
Brake fluid		100	+				+	-		+	+	-	-	0	+	-	-	-
Butyric acid			-	-	0	0	+	0	+	+	+	0	0	+	+	-	0	0
Cyclohexanone			+	+	+	0	0	-	+	0	0	+	+	-	-	-	-	-
Diesel oil			+				+	+	-	+	+	+	+	-	+	-	+	-
Diethylamine			+	+	+	-	0	-	-	0	+	+	+	+	-	-	-	-
Dimethylamine			+	+	+	-	0	-	-	0	+	+	+	+	0		-	-
Glacial acetic acid		50	-	-	-	-	-	-	0	+	-	-	-	-	+	-	-	-
Acetic acid	20		-	-	0	0	+	-	+	+	0	0	0	0	+	-	-	0
Ester			+	+	+	0	-	-	-	0	+			-	+	-	-	-
Ethanol			0	0	0	0	+	0	+	+	+	+	+	-	+	+	+	+
Ether			+	+	+	-	0	-	0	0	+	+	+	0	+	-	+	-
Greases			+	+	+	+	+	+	0	0				0	+	-	+	0
Formaldehyde			0	0	0	-	0	-	-	0		+	+	+	0	0	+	0
Gear oil		100	+				+	+		-	+	+	+	+	-	-	+	-
Halogens (fluorine, chlorine, bromine, iodine)			-	-	-	+	-	-	-	-	-	-	-	-	-	-	+	-
Hydraulic oil		20	+				0	+		-	+	+	+	-	+	-	+	-
Potassium hydroxide solution			+	+	+	-	+	0	+		-	+	+	+	+	0	+	-
Kerosene		20	+				+				+	+	+	-	0	-	+	-
Ketones			+	+	+	0	0	-	+	0	0	+	+	-	-	-	-	-
Hydrocarbons, aliphatic			+	+	+	+	+	+	0	0	+	+	+	-	+	+	+	-
Hydrocarbons, aromatic			+	+	+	-	0	-	0	0	+	+	+	-	-	-	+	-
Hydrocarbons, chlorinated			0	0	0	-	+	-	-	-	0	-	-	-	-	-	+	-
Hydrocarbons, unsaturated chlorinated			0	0	0	-	+	-	-	-	0	0	0	-	-	-	+	-
Fuels			+	+	+	0	+	0	0	-	+	+	+	-	-	-	+	-
Alkalis, weak			+	+	+	-	+	0	+	+	+	+	+	+	+	0	+	0
Alkalis, strong			0	-	-	-	+	-	+		+	-	-	+	0	0	-	-
Inorganic salt solutions			+	+	+	-	+	+	+	+	+	+	+	+	+	+	+	+
Machine oil			+				+				+	+	+	0	+	-	+	-
Metal chloride			+	+	+	-	+	+	+	+	+	+	+	+	+	+	+	+
Metal sulfate			+	+	+	-	+	+	+	+	+	+	+	+	+	+	+	+
Metal nitrate			+	+	+	-	+	+	+	+	+	+	+	+	+	+	+	+
Methanol			0	0	0	0	+	0	+	+	+	+	+	-	+	+	-	+
Methylamine			+	+	+	-	0	-	-	0	+	+	+	+	+	0	0	-
Lactic acid	10	20	+				+	+	+	+	+	+	+	-	+	+	+	+
Mineral oil			+	+	+		+	+	+	-	+	+	+	-	+	-	+	-
Motor oil		120	+	+	+	0	+	+	+	-	+	+	+	-	+	-	+	-
Sodium hydroxide solution	50	50	0	0	+	-	+	+	+	+	-	+	+	+	+	0	0	0
Nitrobenzene			0				0	-		0	+	-	-	-	0	+	0	-
Ozone			0	0	0	-	0	-	+	+	0	0	+	+	+	0	+	-
Propyl alcohol			0	0	0	0	+	0	+	+	+	+	+	-	+	+	+	+
Nitric acid	30	20	-	0	-	0	-	-	+	0	0	0	0	-	+	-	+	-
Hydrochloric acid		20	-				-	0	+	0	0	-	-	-	+	0	+	0
Sulfuric acid	50	50	-	0	-	0	-	-	+	+	-	0	0	+	+	0	+	-
Salt water		20	+	+	+	+	+	+	+	+	+	+	+	+	+	+	+	+
Turpentine			0	0	0	+	-	+	-	-	+	0	0	-	-	-	+	-
UV resistance			+	+	+	0	0	-	-	-	+	+	+	0	0	+	+	+
Detergent alkalis	2	100	0				+	+		+	+	+	+	-	+	+	+	0
Water (dist.)		20												+				
Water, cold			+	+	+	+	+	+	+	+	+	+	+	+	+	+	+	+
Water, hot			-	-	-	-	+	+	+	+	-	+	+	+	+	0	+	0
Citric acid	10		+				+	+	+	+	+			+	+	+	+	+

* The irradiated PUR version is generally more resistant than the non-irradiated version. This cannot be quantified and must be checked in individual cases.

The information in the table has been gathered from the recommendations of our plastic suppliers.

Since individual operating conditions can also affect the usability of each product, this information should be used as a guide only.

For applications where no prior experience exists, we recommend that the user carries out preliminary tests.

Insulation coordination for electrical equipment within low-voltage systems

Dimensioning of clearances and creepage distances according to DIN EN 60664-1/VDE 0110-1.

This part of the standard, based on IEC 60664, contains specifications for the insulation coordination of equipment in low-voltage systems. This part is applicable for equipment to be used at an altitude of up to 2000 m above sea level. This basic safety standard is primarily aimed at technical committees, and if suitable product directives are not available for equipment, it can be applied at the user's own responsibility. International and European product standards cited in this catalog contain specifications for insulation coordination according to DIN EN 60664/VDE 0110-1.

Insulation coordination

Insulation coordination includes the selection of electrical insulation properties for equipment as regards intended applications and ambient conditions. Separate requirements must be applied for clearances and creepage distances and for rigid insulation. The surge voltages to be expected, characteristics of surge protective devices, and pollution at the intended site must be considered when dimensioning clearances. Clearances are then dimensioned according to the external or internal surge voltages to be expected. Different surge voltages, grouped into categories, i.e., a value that specifies a rated impulse voltage, determine the required clearance directly. These surge voltage categories (I to IV) are mainly based on a statistical study, and are used for equipment that is directly supplied by low-voltage networks. Definitions of the individual categories are provided below as an extract of DIN EN 60664/VDE 0110-1.

The clearances can be calculated according to Table 2 (minimum clearances) depending on the homogeneity level of the field between the electrodes (case A – non-homogeneous field, case B – homogeneous field).

Clearances according to case A are capable of withstanding the assigned impulse voltages under all conditions. Equipment that is dimensioned according to case A can therefore be used without any further testing. Clearance values according to case B are based on ideal conditions. Clearance values which fall between case A and case B must be proven by means of an impulse voltage test.

The voltages present, the properties of insulation materials, the pollution to be

expected, and safety measures against pollution are considered when dimensioning creepage distances.

The effect of pollution is considered when determining the clearances and creepage distances according to three intensity levels (pollution degree 1 to 3).

The creepage distance is based on the rated voltage that is derived from the working voltage or nominal mains voltage. The minimum creepage distances are assigned to the rated voltages according to the pollution degree in Table 4.

If the respective product descriptions do not contain any additional specifications, the products presented in this catalog are dimensioned for surge voltage category III and pollution degree 3 according to this regulation (DIN EN 60664-1/VDE 0110-1).

Surge voltage categories I to IV

– Equipment in **surge voltage category IV** can be used at the terminal point of the installation.

Note: examples of such equipment include electricity meters and primary devices for overcurrent protection.

– Equipment in **surge voltage category III** can be used in fixed installations and is intended for such cases where there are special requirements for the reliability and availability of the equipment.

Note: examples of such equipment include switches in fixed installations and equipment for industrial use with permanent connection to the fixed installation.

– Equipment in **surge voltage category II** is power-consuming equipment that is supplied by the fixed installation.

Note: examples of such equipment include household appliances, portable tools, other domestic appliances, and similar devices.

– Equipment in **surge voltage category I** can be connected to circuits where measures have been taken to limit the surge voltages to a suitable lower value.

Pollution degrees 1 to 4

The following four pollution degrees have been defined for the micro-environment in order to determine clearances and creepage distances:

– Pollution degree 1

No pollution or only dry, non-conductive pollution occurs. The pollution has no effect.

– Pollution degree 2

Only non-conductive pollution occurs. However, temporary conductivity due to condensation must occasionally be taken into consideration.

– Pollution degree 3

Conductive pollution occurs or dry, non-conductive pollution which becomes conductive, since condensation is to be expected.

– Pollution degree 4

Permanent conductivity occurs, caused by conductive dust, rain or moisture.

Insulation material

DIN EN 60664/VDE 0110-1 classifies insulation materials into four groups depending on their CTI values that were obtained using solution A as per IEC 60112.

These are:

Insulation material group I: $600 \leq CTI$

Insulation material group II: $400 \leq CTI \leq 600$

Insulation material group IIIa: $175 \leq CTI < 400$

Insulation material group IIIb: $100 \leq CTI < 175$

The comparative tracking index of the creepage distance formation must have been determined based on suitable samples using test solution A as specified in DIN IEC 60112.

The proof tracking index of the creepage distance formation (PTI) is used as proof of the creepage current properties of insulation materials.

Dimensioning of clearances

Schematic for determining clearances

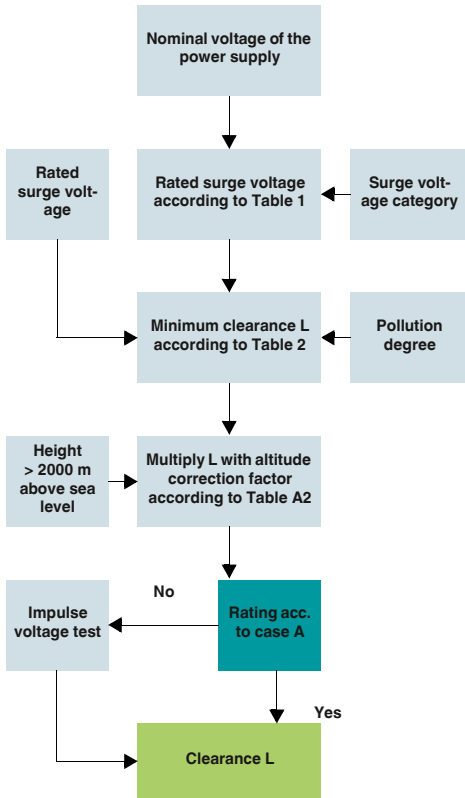

Rated surge voltages for equipment that is directly supplied by the low-voltage network (extract from Table 1)

Nominal voltage of the power supply system 1) (mains acc. to IEC 60038 3)		Conductor-neutral conductor voltage derived from the total nominal AC voltage or nominal DC voltage [V]	Rated surge voltage 2) [V]			
Three-phase [V]	Single-phase [V]		Surge voltage category 4)			
			I	II	III	IV
		50	330	500	800	1500
		100	500	800	1500	2500
		150	800	1500	2500	4000
230/400	277/480	300	1500	2500	4000	6000
		400/690	2500	4000	6000	8000
		1000	4000	6000	8000	12000

1) Refer to Appendix B for application in existing deviating low-voltage networks and their nominal voltages.

2) Equipment with this rated surge voltage may be used in systems according to IEC 60364-4-443.

3) The slash, i.e., /, indicates a three-phase four-conductor system. The lower value is the conductor-to-neutral conductor voltage, whereas the higher value is the conductor-to-conductor voltage. When only one value is specified, it refers to a three-phase three-conductor system, and indicates the conductor-to-conductor voltage.

4) Refer to 2.2.2.1.1 for an explanation of surge voltage categories.

Minimum clearances for surge voltages (extract from Table 2)

Required rated impulse voltage 1) 5) [kV]	Condition A Non-homogeneous field (refer to 3.15)			Condition B Homogeneous field (refer to 3.14)		
	Pollution degree 6)					
	1 [mm]	2 [mm]	3 [mm]	1 [mm]	2 [mm]	3 [mm]
0.33 2)	0.01	0.2 3) 4)	0.8 4)	0.01	0.2 3) 4)	0.8 4)
0.40	0.02			0.02		
0.5 2)	0.04			0.04		
0.60	0.06			0.06		
0.80 2)	0.10			0.10		
1.0	0.15			0.15		
1.2	0.25	0.25		0.2		
1.5 2)	0.5	0.5		0.3	0.3	
2.0	1.0	1.0	1.0	0.45	0.45	
2.5 2)	1.5	1.5	1.5	0.6	0.6	
3.0	2.0	2.0	2.0	0.8	0.8	
4.0 2)	3	3	3	1.2	1.2	1.2
5.0	4	4	4	1.5	1.5	1.5
6.0 2)	5.5	5.5	5.5	2	2	2
8.0 2)	8	8	8	3	3	3
10	11	11	11	3.5	3.5	3.5
12 2)	14	14	14	4.5	4.5	4.5
15	18	18	18	5.5	5.5	5.5
20	25	25	25	8	8	8
25	33	33	33	10	10	10
30	40	40	40	12.5	12.5	12.5
40	60	60	60	17	17	17
50	75	75	75	22	22	22
60	90	90	90	27	27	27
80	130	130	130	35	35	35
100	170	170	170	45	45	45

1) This voltage is:

- For function insulation: the highest surge voltage expected for the clearance
- For basic insulation, if influenced directly or considerably by surge voltages from the low-voltage network: the rated surge voltage of the equipment
- For a different basic insulation: the highest impulse voltage possible in the circuit

2) Preferred values

3) For PCBs, the values of pollution degree 1 are applicable, except that no deviation below the value of 0.04 mm is permitted, as specified in Table 4.

4) Minimum clearances for pollution degrees 2 and 3 are based on the corresponding creepage distances. This resistance is reduced due to the effects of humidity.

5) Values can be interpolated for parts or circuits within equipment that are subjected to impulse voltages.

6) The distances for pollution degree 4 are equal to those for pollution degree 3, except that the minimum clearance is 1.6 mm.

Altitude correction factors (extract from Table A.2)

Height in m	Normal air pressure in kPa	Multiplication factor for gaps
2000	80.0	1.00
3000	70.0	1.14
4000	62.0	1.29
5000	54.0	1.48
6000	47.0	1.70
7000	41.0	1.95
8000	35.5	2.25
9000	30.5	2.62
10000	26.5	3.02
15000	12.0	6.67
20000	5.5	14.50

Dimensioning of creepage distances

Schematic for determining creepage distances

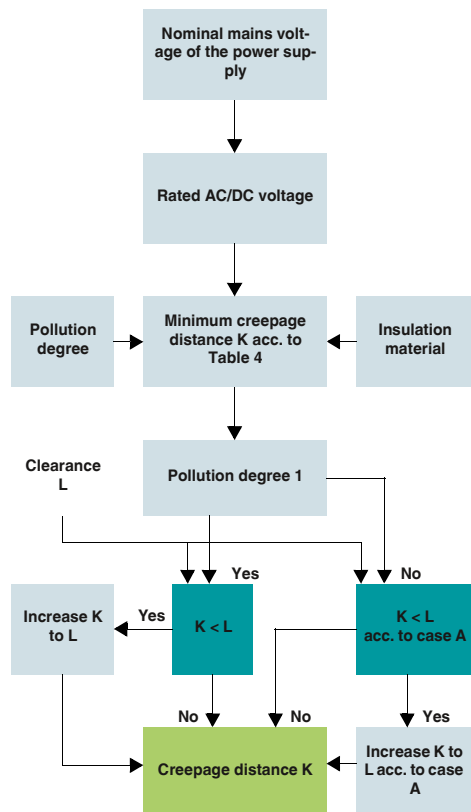

Single-phase three or two-conductor AC or DC voltage systems (extract from Table 3a)

Nominal voltage of the power supply system (mains *)	Voltages for Table 4	
	For conductor-conductor insulation 1)	For conductor-ground insulation 1)
	All systems	Three-conductor systems center point grounded
[V]	[V]	[V]
12.5	12.5	-
24	25	-
30	32	-
42		
48	50	-
50 **)		
60	63	-
30-60	63	32
100 **)	100	-
110		
120	125	-
150 **)	160	-
220	250	-
110-220		125
220-240	250	
300 **)	320	-
220-440	500	250
600 **)	630	-
480-960	1000	500
1000 **)	1000	-

1) Conductor-ground insulation levels for non-grounded systems or those grounded through impedance correspond to conductor-conductor insulation levels as the operating voltage of every conductor to ground can, in practice, reach the conductor-conductor voltage. This is due to the fact that the actual voltage to ground is determined by the insulation resistance and the capacitive reactance of each conductor to ground. A low (but permissible) insulation resistance of one conductor can thereby practically ground it and increase the other two to conductor-conductor voltage to ground.

*) Refer to 2.2.1 for correlation with the rated voltage.

**) These values correspond to the values in Table 1.

Three-phase four or three-conductor AC voltage systems (extract from Table 3b)

Nominal voltage of the power supply system (mains *)	Voltages for Table 4		
	For conductor-conductor insulation	Insulation for conductor-ground	
		All systems	Three-phase four-conductor systems with grounded neutral conductor 2)
[V]	[V]	[V]	[V]
60	63	32	63
110/120/127	125	80	125
150 **)	160	-	160
208	200	125	200
220/230/240	250	160	250
300 **)	320	-	320
380/400/415	400	250	400
440	500	250	400
480/500	500	320	500
575	630	400	630
600 **)	630	-	630
660/690	630	400	630
720/830	800	500	800
960	1000	630	1000
1000 **)	1000	-	1000

1) Conductor-ground insulation levels for non-grounded systems or those grounded through impedance correspond to conductor-conductor insulation levels as the operating voltage of every conductor to ground can, in practice, reach the conductor-conductor voltage. This is due to the fact that the actual voltage to ground is determined by the insulation resistance and the capacitive reactance of each conductor to ground. A low (but permissible) insulation resistance of one conductor can thereby practically ground it and increase the other two to conductor-conductor voltage to ground.

2) For equipment designed for use in three-phase four-conductor and three-phase three-conductor systems, grounded as well as non-grounded, only the values for three-conductor systems may be used.

*) Refer to 2.2.1 for correlation with the rated voltage.

**) These values correspond to the values in Table 1.

















































Creepage distances to prevent failures occurring due to creepage (extract from Table 4)

Voltage 1) r.m.s. value	Minimum creepage distances											
	Printed circuits			Pollution degree								
	Pollution degree			1			2			3		
	All insulation material groups	All insulation material groups except IIb	All insulation material groups	Insulation material group			Insulation material group					
[V]	[mm]	[mm]	[mm]	I	II	III	I	II	III 2)			
10	0.025	0.04	0.08	0.40	0.40	0.40	1.00	1.00	1.00			
12.5	0.025	0.04	0.09	0.42	0.42	0.42	1.05	1.05	1.05			
16	0.025	0.04	0.10	0.45	0.45	0.45	1.10	1.10	1.10			
20	0.025	0.04	0.11	0.48	0.48	0.48	1.20	1.20	1.20			
25	0.025	0.04	0.125	0.50	0.50	0.50	1.25	1.25	1.25			
32	0.025	0.04	0.14	0.53	0.53	0.53	1.30	1.30	1.30			
40	0.025	0.04	0.16	0.56	0.80	1.10	1.4	1.6	1.8			
50	0.025	0.04	0.18	0.60	0.85	1.20	1.5	1.7	1.9			
63	0.040	0.63	0.20	0.63	0.90	1.25	1.6	1.8	2.0			
80	0.063	0.10	0.22	0.67	0.95	1.3	1.7	1.9	2.1			
100	0.10	0.16	0.25	0.71	1.00	1.4	1.8	2.0	2.2			
125	0.16	0.25	0.28	0.75	1.05	1.5	1.9	2.1	2.4			
160	0.25	0.40	0.32	0.80	1.1	1.6	2.0	2.2	2.5			
200	0.40	0.63	0.42	1.00	1.4	2.0	2.5	2.8	3.2			
250	0.56	1.00	0.56	1.25	1.8	2.5	3.2	3.6	4.0			
320	0.75	1.60	0.75	1.60	2.2	3.2	4.0	4.5	5.0			
400	1.00	2.00	1.00	2.00	2.8	4.0	5.0	5.6	6.3			
500	1.30	2.50	1.30	2.50	3.6	5.0	6.3	7.1	8.0			
630	1.80	3.20	1.8	3.2	4.5	6.3	8.0	9	10.0			
800	2.40	4.00	2.4	4.0	5.6	8.0	10.0	11	12.5			
1000	3.20	5.00	3.2	5.0	7.1	10	12.5	14	16.0			
1250			4.2	6.3	9	12.5	16	18	20			
1600			5.6	8	11	16	20	22	25			
2000			7.5	10	14	20	25	28	32			
2500			10	12.5	18	25	32	36	40			
3200			12.5	16	22	32	40	45	50			
4000			16	20	28	40	50	56	63			
5000			20	25	36	50	63	71	80			
6300			25	32	45	63	80	90	100			
8000			32	40	56	80	100	110	125			
10000			40	50	71	100	125	140	160			

1) This voltage is:
a) For function insulation: the working voltage
b) For basic and additional insulation of a circuit supplied directly by the low-voltage network: either the voltage selected from Table 3a or 3b on the basis of the rated voltage of the equipment or the rated insulation voltage;
c) For basic and additional insulation of systems, equipment, and internal circuits which are not supplied directly from the mains: the highest r.m.s. value of the voltage that, within the bounds of the rated data, can occur in the system, the equipment or the internal circuit, when supplied with rated voltage and in the case of the most unfavorable combination of operating conditions.

2) With pollution degree 3, insulation material group IIIb is not recommended for use if voltages are greater than 630 V.

Certification bodies and safety marks

Certification bodies and approvals	Country code	 Explosion protection	Country code	Ship classification societies	Country code
 IECEE CB Scheme (in combination with certifying body)	International	 International Electrotechnical Commission	International	 Bureau Veritas	FR
 CENELEC Certification Agreement (CCA inspection report) (in combination with certifying body)	EU	 DEKRA Certification B.V.	NL	 Germanischer Lloyd AG	DE
 Canadian Standards Association (CSA)	CA	 Physikalisch-Technische Bundesanstalt	DE	 Lloyd's Register of Shipping	GB
 Canadian Standards Association (CSA) - CSA approval for the USA -	US	 KIWA Nederland B.V.	NL	 Nippon Kaiji Kyokai	JP
 Canadian Standards Association. (CSA) Combined logo - CSA approval for Canada and the USA -	CA US	 QS Schaffhausen AG	CH	 Det Norske Veritas	NO
 Underwriters Laboratories Inc. (UL)	US	 VTT Expert Services Oy	FI	 Polski Rejestr Statków	PL
 Underwriters Laboratories Inc. (UL) - UL approval for Canada -	CA	 IBEXU Institut für Sicherheitstechnik GmbH	DE	 Russian Maritime Register of Shipping	RU
 Underwriters Laboratories Inc. (UL) Combined logo - UL approval for the USA and Canada -	US CA	 TÜV Rheinland do Brasil	BR	 Korean Register of Shipping	KR
 INSIEME PER LA QUALITA'E LA SICUREZZA	IT	 Technischer Überwachungsverein Nord	DE	 American Bureau of Shipping	US
 Eurasian Conformity	BY KZ RU	 DEKRA EXAM GmbH	DE		
 DEKRA Certification B.V.	NL	 Canadian Standards Association (CSA)	CA		
 Österreichischer Verband für Elektrotechnik	AT	 Canadian Standards Association (CSA) - CSA approval for the USA -	US		
 electrosuisse SEV Verband für Elektro-, Energie- und Informationstechnik	CH	 Canadian Standards Association. (CSA) Combined logo - CSA approval for Canada and the USA -	CA US		
 Verband Deutscher Elektrotechniker e.V. (VDE) - Approval of drawings - Reports with production monitoring	DE	 Underwriters Laboratories Inc. (UL)	US		
 Berufsgenossenschaft (BG) GS - Geprüfte Sicherheit	DE	 Underwriters Laboratories Inc. (UL) - UL approval for Canada -	CA		
 Intertek ETL Listed - Approval for the USA -	US	 Underwriters Laboratories Inc. (UL) Combined logo - UL approval for the USA and Canada -	US CA		
 Intertek ETL Listed - Approval for Canada -	CA	 FM Approvals	US		
 Intertek ETL Listed - Approval for the USA and Canada -	US CA	 Eurasian Conformity for Ex-products	BY KZ RU		
 TÜV Rheinland Industrie Service GmbH	DE				
 China Compulsory Certificate	CN				

Index

Alphabetical

Type	Order No.	Page	Type	Order No.	Page	Type	Order No.	Page	Type	Order No.	Page
A											
A 0,5 - 6	3200218	294	A-INL-PG29-N-S	1411263	686	CA-06P1N8A8006S	1619576	78	CA-07S1N128006S	1619575	78
A 0,75-10	3200234	294	A-INL-PG29-P-GY	1411227	682	CA-06P1N8A8007	1619721	79	CA-07S1N128007	1619720	79
A 1 -10	3200250	294	A-INL-PG36-N-S	1411264	686	CA-06P1N8A8007S	1619531	78	CA-07S1N128007S	1619530	78
A 1,5 -10	3200276	294	A-INL-PG36-P-GY	1411228	682	CA-06P1N8A8008	1619656	79	CA-07S1N128008	1619655	79
A-EXB-20-66L-N-S	1411117	702	A-INL-PG42-N-S	1411265	686	CA-06P1N8A8008S	1619505	78	CA-07S1N128008S	1619504	78
A-EXB-20-66L-S-S	1411118	702	A-INL-PG42-P-GY	1411229	682	CA-06P1N8A800DN	1619773	79	CA-07S1N12800DN	1619772	79
A-EXB-25-66L-N-S	1411120	702	A-INL-PG48-N-S	1411266	686	CA-06P1N8A800DNS	1619602	78	CA-07S1N12800DNS	1619601	78
A-EXB-25-66L-S-S	1411121	702	A-INL-PG48-P-GY	1411230	682	CA-06P1N8A9006	1620142	80	CA-07S1N129006	1620141	80
A-EXSH-M20-68L-N-S	1411104	701	A-INL-PG7-N-S	1411255	686	CA-06P1N8A9007	1620116	80	CA-07S1N129007	1620115	80
A-EXSH-M20-68L-S-S	1411110	702	A-INL-PG7-P-GY	1411221	682	CA-06P1N8A9008	1620043	80	CA-07S1N129008	1620042	80
A-EXSH-M25-68L-N-S	1411107	701	A-INL-PG9-N-S	1411256	686	CA-06P1N8A900DN	1620169	80	CA-07S1N12900DN	1620168	80
A-EXSH-M25-68L-S-S	1411108	701	A-INL-PG9-P-GY	1411222	682	CA-06P1N8AHZ00	1619848	85	CA-07S1N12H200	1619847	85
A-EXSH-M32-68L-N-S	1411109	701	A-INLE-M12-N-S	1411267	688	CA-06S1N122S00	1619993	83	CA-07S1N8A2S00	1619987	83
A-EXSH-M32-68L-S-S	1411110	701	A-INLE-M16-N-S	1411268	688	CA-06S1N126Y00	1619877	82	CA-07S1N8A6Y00	1619871	82
A-EXSH-M40-68L-N-S	1411111	701	A-INLE-M20-N-S	1411269	688	CA-06S1N126Z00	1619903	81	CA-07S1N8A6Z00	1619897	81
A-EXSH-M40-68L-S-S	1411112	701	A-INLE-M25-N-S	1411270	688	CA-06S1N128006	1619750	79	CA-07S1N8A8006	1619744	79
A-EXSH-M32-68L-N-S	1411109	701	A-INLE-M32-N-S	1411271	688	CA-06S1N128006S	1619579	78	CA-07S1N8A8006S	1619573	78
A-EXSH-M32-68L-S-S	1411110	701	A-INLE-M40-N-S	1411272	688	CA-06S1N128007	1619724	79	CA-07S1N8A8007	1619718	79
A-EXSH-M40-68L-N-S	1411111	701	A-INLE-M50-N-S	1411273	688	CA-06S1N128007S	1619534	78	CA-07S1N8A8007S	1619528	78
A-EXSH-M40-68L-S-S	1411112	701	A-INLE-M63-N-S	1411274	688	CA-06S1N128008	1619659	79	CA-07S1N8A8008	1619653	79
A-EXSH-M50-68L-N-S	1411113	701	A-INLE-PG11-N-S	1411277	689	CA-06S1N128008S	1619508	78	CA-07S1N8A8008S	1619502	78
A-EXSH-M50-68L-S-S	1411114	701	A-INLE-PG13,5-N-S	1411278	689	CA-06S1N12800DN	1619776	79	CA-07S1N8A800DN	1619770	79
A-EXSH-M63-68L-N-S	1411115	701	A-INLE-PG16-N-S	1411279	689	CA-06S1N12800DNS	1619605	78	CA-07S1N8A800DNS	1619599	78
A-EXSH-M63-68L-S-S	1411116	701	A-INLE-PG21-N-S	1411280	689	CA-06S1N129006	1620145	80	CA-07S1N8A9006	1620139	80
A-INB-M12-69KN-P-BK	1415223	694	A-INLE-PG29-N-S	1411281	689	CA-06S1N129007	1620119	80	CA-07S1N8A9007	1620081	80
A-INB-M12-69KN-P-LG	1415222	694	A-INLE-PG36-N-S	1411282	689	CA-06S1N129008	1620046	80	CA-07S1N8A9008	1620038	80
A-INB-M12-69KN-S-S	1415224	694	A-INLE-PG7-N-S	1411275	689	CA-06S1N12900DN	1620172	80	CA-07S1N8A900DN	1620166	80
A-INE-PG13/16-N-NS-S	1415219	686	A-INLE-PG9-N-S	1411276	689	CA-06S1N12HZ00	1619851	85	CA-07S1N8AHZ00	1619845	85
A-INE-PG16/21-N-NS-S	1415220	696	A-INR-PG16/13-N-NS-S	1415216	696	CA-06S1N8A2S00	1619991	83	CA-09P1N122S00	1619972	83
A-INE-PG21/29-N-NS-S	1415221	696	A-INR-PG21/16-N-NS-S	1415217	696	CA-06S1N8A6Y00	1619875	82	CA-09P1N126Y00	1619868	82
A-INL-M12-N-S	1411240	685	A-INR-PG29/21-N-NS-S	1415218	696	CA-06S1N8A6Z00	1619901	81	CA-09P1N126Z00	1619894	81
A-INL-M12-P-BK	1411213	681	A-INSP-M20-65N-P-BK	1415206	695	CA-06S1N8A8006	1619748	79	CA-09P1N128006	1619741	79
A-INL-M12-P-GY	1411205	680	A-INSP-M25-65N-P-BK	1415207	695	CA-06S1N8A8006S	1619577	78	CA-09P1N128006S	1619570	78
A-INL-M16-N-S	1411241	685	A-INSP-M32-65N-P-BK	1415208	695	CA-06S1N8A8007	1619722	79	CA-09P1N128007	1619715	79
A-INL-M16-P-BK	1411214	681	A-INSP-M40-65N-P-BK	1415210	695	CA-06S1N8A8007S	1619532	78	CA-09P1N128007S	1619525	78
A-INL-M16-P-GY	1411206	680	A-INSP-PG16-65N-P-BK	1415213	695	CA-06S1N8A8008	1619657	79	CA-09P1N128008	1619650	79
A-INL-M20-N-S	1411242	685	A-INSP-PG21-65N-P-BK	1415214	695	CA-06S1N8A8008S	1619506	78	CA-09P1N128008S	1619499	78
A-INL-M20-P-BK	1411215	681	A-INSP-PG29-65N-P-BK	1415215	695	CA-06S1N8A800DN	1619774	79	CA-09P1N12800DN	1619767	79
A-INL-M20-P-GY	1411207	680	A-SEW-20-P-W	1411283	703	CA-06S1N8A800DNS	1619603	78	CA-09P1N12800DNS	1619596	78
A-INL-M20-S-S	1411249	703	A-SEW-25-P-W	1411284	703	CA-06S1N8A9006	1620143	80	CA-09P1N129006	1620136	80
A-INL-M25-N-S	1411243	685	A-SEW-32-P-W	1411285	703	CA-06S1N8A9007	1620117	80	CA-09P1N129007	1620078	80
A-INL-M25-P-BK	1411216	681	A-SEW-40-P-W	1411286	703	CA-06S1N8A9008	1620044	80	CA-09P1N129008	1620035	80
A-INL-M25-P-GY	1411208	680	A-SEW-50-P-W	1411287	703	CA-06S1N8A900DN	1620170	80	CA-09P1N12900DN	1620163	80
A-INL-M25-S-S	1411250	703	A-SEW-63-P-W	1411288	703	CA-06S1N8AHZ00	1619849	85	CA-09P1N12AD00	1621746	84
A-INL-M32-N-S	1411244	685	ALU-SB	1404531	460	CA-07P1N122S00	1619988	83	CA-09P1N12HZ00	1619842	85
A-INL-M32-P-BK	1411217	681	ASI CC ADR	2741338	429	CA-07P1N126Y00	1619872	82	CA-09P1N8A2S00	1619970	83
A-INL-M32-P-GY	1411209	680	ASI CC ADR CAB CINCH	2741341	430	CA-07P1N126Z00	1619898	81	CA-09P1N8A6Y00	1619866	82
A-INL-M32-S-S	1411251	703				CA-07P1N128006	1619745	79	CA-09P1N8A6Z00	1619892	81
A-INL-M40-N-S	1411246	685				CA-07P1N128006S	1619574	78	CA-09P1N8A8006	1619739	79
A-INL-M40-P-BK	1411218	681				CA-07P1N128007	1619719	79	CA-09P1N8A8006S	1619568	78
A-INL-M40-P-GY	1411210	680				CA-07P1N128007S	1619529	78	CA-09P1N8A8007	1619711	79
A-INL-M40-S-S	1411252	703				CA-07P1N128008	1619654	79	CA-09P1N8A8007S	1619523	78
A-INL-M50-N-S	1411247	685				CA-07P1N128008S	1619503	78	CA-09P1N8A8008	1619648	79
A-INL-M50-P-BK	1411219	681	BMKL 11,5 (108X16) WH	0821797	431	CA-07P1N12800DN	1619771	79	CA-09P1N8A8008S	1619497	78
A-INL-M50-P-GY	1411211	680	BMKL 64X16 WH	0821807	430	CA-07P1N12800DNS	1619600	78	CA-09P1N8A800DN	1619765	79
A-INL-M50-S-S	1411253	703				CA-07P1N129006	1620140	80	CA-09P1N8A800DNS	1619594	78
A-INL-M63-N-S	1411248	685				CA-07P1N129007	1620114	80	CA-09P1N8A9006	1620134	80
A-INL-M63-P-BK	1411220	681				CA-07P1N129008	1620041	80	CA-09P1N8A9007	1620076	80
A-INL-M63-P-GY	1411212	680				CA-07P1N12900DN	1620167	80	CA-09P1N8A9008	1620033	80
A-INL-M63-S-S	1411254	703				CA-07P1N12HZ00	1619846	85	CA-09P1N8A900DN	1620161	80
A-INL-NPT1-N-S	1416012	687				CA-07P1N129007	1620114	80	CA-09P1N8A9006	1620134	80
A-INL-NPT1-P-BK	1411239	684	CA-06P1N122S00	1619992	83	CA-07P1N8A2S00	1619986	83	CA-09P1N8AAD00	1621735	84
A-INL-NPT1-P-GY	1411235	683	CA-06P1N126Y00	1619876	82	CA-07P1N8A6Y00	1619870	82	CA-09P1N8AHZ00	1619791	85
A-INL-NPT1-P-S	1411235	683	CA-06P1N126Z00	1619902	81	CA-07P1N8A6Z00	1619896	81	CA-09S1N122S00	1619973	83
A-INL-NPT1/2-N-S	1416010	687	CA-06P1N128006	1619749	79	CA-07P1N8A8006	1619743	79	CA-09S1N126Y00	1619869	81
A-INL-NPT1/2-P-BK	1411237	684	CA-06P1N128006S	1619578	78	CA-07P1N8A8006S	1619572	78	CA-09S1N126Z00	1619895	81
A-INL-NPT1/2-P-GY	1411233	683	CA-06P1N128007	1619723	79	CA-07P1N8A8007	1619717	79	CA-09S1N128006	1619742	79
A-INL-NPT3/4-N-S	1416011	687	CA-06P1N128007S	1619533	78	CA-07P1N8A8007S	1619527	78	CA-09S1N128006S	1619571	78
A-INL-NPT3/4-P-BK	1411238	684	CA-06P1N128008	1619658	79	CA-07P1N8A8008	1619652	79	CA-09S1N128007	1619716	79
A-INL-NPT3/4-P-GY	1411234	683	CA-06P1N128008S	1619507	78	CA-07P1N8A8008S	1619501	78	CA-09S1N128007S	1619526	78
A-INL-NPT3/8-N-S	1416009	687	CA-06P1N12800DN	1619775	79	CA-07P1N8A800DN	1619769	79	CA-09S1N128008	1619651	79
A-INL-NPT3/8-P-BK	1411236	684	CA-06P1N12800DNS	1619604	78	CA-07P1N8A800DNS	1619598	78	CA-09S1N128008S	1619500	78
A-INL-NPT3/8-P-GY	1411231	683	CA-06P1N129006	1620144	80	CA-07P1N8A9006	1620138	80	CA-09S1N12800DN	1619768	79
A-INL-PG11-N-S	1411257	686	CA-06P1N129007	1620018	80	CA-07P1N8A9007	1620080	80	CA-09S1N12800DNS	1619597	78
A-INL-PG11-P-GY	1411223	682	CA-06P1N129008	1620045	80	CA-07P1N8A9008	1620037	80	CA-09S1N129006	1620137	80
A-INL-PG13,5-N-S	1411259	686	CA-06P1N12900DN	1620171	80	CA-07P1N8A900DN	1620165	80	CA-09S1N129007	1620079	80
A-INL-PG13,5-P-GY	1411224	682	CA-06P1N12HZ00	1619850	85	CA-07P1					

Type	Order No.	Page	Type	Order No.	Page	Type	Order No.	Page	Type	Order No.	Page
CA-09S1N8A6Z00	1619893	81	CA-12P1N8A6Y00	1619862	82	CA-17P1N128008S	1619482	78	CA-19S1N128007S	1619510	78
CA-09S1N8A8006	1619740	79	CA-12P1N8A6Z00	1619888	81	CA-17P1N12800DN	1619755	79	CA-19S1N128008	1619635	79
CA-09S1N8A8006S	1619569	78	CA-12P1N8A8006	1619735	79	CA-17P1N12800DNS	1619584	78	CA-19S1N128008S	1619479	78
CA-09S1N8A8007	1619714	79	CA-12P1N8A8006S	1619546	78	CA-17P1N129006	1620124	80	CA-19S1N12800DN	1619752	79
CA-09S1N8A8007S	1619524	78	CA-12P1N8A8007	1619707	79	CA-17P1N129007	1620051	80	CA-19S1N12800DNS	1619581	78
CA-09S1N8A8008	1619649	79	CA-12P1N8A8007S	1619519	78	CA-17P1N129008	1620023	80	CA-19S1N129006	1620121	80
CA-09S1N8A8008S	1619498	78	CA-12P1N8A8008	1619644	79	CA-17P1N12900DN	1620150	80	CA-19S1N129007	1620048	80
CA-09S1N8A800DN	1619766	79	CA-12P1N8A8008S	1619488	78	CA-17P1N12A000	1621745	84	CA-19S1N129008	1620020	80
CA-09S1N8A800DNS	1619595	78	CA-12P1N8A800DN	1619761	79	CA-17P1N12H200	1619781	85	CA-19S1N12900DN	1620147	80
CA-09S1N8A9006	1620135	80	CA-12P1N8A800DNS	1619590	78	CA-17P1N8A2S00	1619958	83	CA-19S1N12HZ00	1619778	85
CA-09S1N8A9007	1620077	80	CA-12P1N8A9006	1620130	80	CA-17P1N8A6Y00	1619854	82	CA-Z0001	1620699	162
CA-09S1N8A9008	1620034	80	CA-12P1N8A9007	1620072	80	CA-17P1N8A6Z00	1619880	81	CA-Z0110	1620700	164
CA-09S1N8A900DN	1620162	80	CA-12P1N8A9008	1620029	80	CA-17P1N8A8006	1619727	78	CA-Z0111	1620701	164
CA-09S1N8A900S	1619841	85	CA-12P1N8A900DN	1620157	80	CA-17P1N8A8006S	1619538	79	CA-Z0112	1620702	164
CA-12F1N8A8502	1619625	93	CA-12P1N8A900DN	1621738	84	CA-17P1N8A8007	1619699	79	CA-Z0120	1620704	164
CA-12F1N8A8502S	1619466	92	CA-12P1N8AA000	1619787	85	CA-17P1N8A8007S	1619511	78	CA-Z0121	1620705	164
CA-12F1N8A8503	1619616	93	CA-12P1N8AHZ00	1619969	83	CA-17P1N8A8008	1619636	79	CA-Z0122	1620706	164
CA-12F1N8A8503S	1619460	92	CA-12S1N122S00	1619969	83	CA-17P1N8A8008S	1619480	78	CASE HC EVO OVERVIEW	5053053	669
CA-12F1N8A8504	1619610	93	CA-12S1N126Y00	1619891	81	CA-17P1N8A8008S	1619753	79	CC-0.8-ST-0.34-MS AU	1452372	41
CA-12F1N8A8504S	1619454	92	CA-12S1N126Z00	1619738	79	CA-17P1N8A800DN	1619582	78	CC-1.0-ST-0.34-MS AU	1452356	41
CA-12F1N8A8504S	1619454	92	CA-12S1N128006	1619738	79	CA-17P1N8A800DNS	1619582	78			
CA-12F1N8A85DU	1619631	93	CA-12S1N128006S	1619567	78	CA-17P1N8A9006	1620122	80	CES-B10-HFFS-PLBK	0801663	668
CA-12F1N8A85DUS	1619472	92	CA-12S1N128007	1619710	79	CA-17P1N8A9006S	1620049	80	CES-B10-SF-PLBK	0801655	669
CA-12F1N8A9502	1620009	94	CA-12S1N128007S	1619522	78	CA-17P1N8A9008	1620021	80	CES-B10-SFC-M	0801645	669
CA-12F1N8A9503	1620003	94	CA-12S1N128008	1619647	79	CA-17P1N8A9008S	1620148	80	CES-B10-SFFS-PLBK	0801660	669
CA-12F1N8A9504	1619997	94	CA-12S1N128008S	1619496	78	CA-17P1N8A900DN	1621744	84	CES-B10-WRG-BK	0801725	668
CA-12F1N8A9504S	1620016	94	CA-12S1N12800DN	1619764	79	CA-17S1N122S00	1619779	85	CES-B10-WRG-BK	1411073	669
CA-12F2N8A8502	1619627	93	CA-12S1N12800DNS	1619593	78	CA-17S1N126Y00	1619961	83	CES-B16-8XSRC-BK	0801662	668
CA-12F2N8A8502S	1619468	92	CA-12S1N129006	1620133	80	CA-17S1N126Y00	1619857	82	CES-B16-SF-PLBK	0801651	669
CA-12F2N8A8503	1619618	93	CA-12S1N129007	1620075	80	CA-17S1N126Z00	1619883	81	CES-B16-SFC-M	0801642	669
CA-12F2N8A8503S	1619462	92	CA-12S1N129008	1620032	80	CA-17S1N128006	1619730	79	CES-B16-SFFS-PLBK	0801659	669
CA-12F2N8A8504	1619612	93	CA-12S1N12900DN	1620160	80	CA-17S1N128006S	1619541	78	CES-B16-WRG-BK	0801726	668
CA-12F2N8A8504S	1619456	92	CA-12S1N12HZ00	1619790	85	CA-17S1N128007	1619702	79	CES-B24-10XSRC-BK	1411074	669
CA-12F2N8A85DU	1619633	93	CA-12S1N12HZ00	1619633	93	CA-17S1N128007S	1619514	78	CES-B24-HFFS-PLBK	0801661	668
CA-12F2N8A85DUS	1619474	92	CA-12S1N8A2S00	1619967	83	CA-17S1N128008	1619639	79	CES-B24-SF-PLBK	0801647	669
CA-12F2N8A9502	1620011	94	CA-12S1N8A6Y00	1619863	82	CA-17S1N128008S	1619483	78	CES-B24-SFC-M	0801641	669
CA-12F2N8A9503	1620005	94	CA-12S1N8A6Z00	1619889	81	CA-17S1N128008S	1619756	79	CES-B24-SFFS-PLBK	0801658	669
CA-12F2N8A9504	1619999	94	CA-12S1N8A8006	1619736	79	CA-17S1N12800DN	1619585	78	CES-B24-WRG-BK	0801727	668
CA-12F2N8A9504S	1620018	94	CA-12S1N8A8006S	1619547	78	CA-17S1N12800DNS	1619585	78	CES-LRC-BK	0801719	670
CA-12M1N8A8502	1619624	93	CA-12S1N8A8007	1619708	79	CA-17S1N129006	1620125	80	CES-LRG-BK	0801671	670
CA-12M1N8A8502S	1619465	92	CA-12S1N8A8007S	1619708	79	CA-17S1N129007	1620052	80	CES-LRG-BK-15	0801671	670
CA-12M1N8A8503	1619615	93	CA-12S1N8A8008	1619645	79	CA-17S1N129008	1620024	80	CES-LRG-BK-16	0801621	670
CA-12M1N8A8503S	1619459	92	CA-12S1N8A8008S	1619489	78	CA-17S1N12900DN	1620151	80	CES-LRG-BK-17	0801624	670
CA-12M1N8A8504	1619609	93	CA-12S1N8A800DN	1619762	79	CA-17S1N12HZ00	1619782	85	CES-LRG-BK-18	0801626	670
CA-12M1N8A8504S	1619453	92	CA-12S1N8A800DNS	1619591	78	CA-17S1N8A2S00	1619959	83	CES-LRG-BK-19	0801629	670
CA-12M1N8A85DU	1619630	93	CA-12S1N8A9006	1620131	80	CA-17S1N8A6Y00	1619855	82	CES-LRG-BK-20	0801631	670
CA-12M1N8A85DUS	1619471	92	CA-12S1N8A9007	1620073	80	CA-17S1N8A6Z00	1619881	81	CES-LRG-BK-21	0801634	670
CA-12M1N8A9502	1620008	94	CA-12S1N8A9008	1620030	80	CA-17S1N8A8006	1619728	78	CES-LRG-BK-22	0801637	670
CA-12M1N8A9503	1620002	94	CA-12S1N8A900DN	1620158	80	CA-17S1N8A8006S	1619539	79	CES-LRG-BK-23	0801638	670
CA-12M1N8A9504	1619996	94	CA-12S1N8AHZ00	1619788	85	CA-17S1N8A8007	1619700	79	CES-LRG-BK-24	0801639	670
CA-12M1N8A9504S	1619623	93	CA-17F1N8A8502	1619623	93	CA-17S1N8A8007S	1619512	78	CES-LRG-BK-25	0801640	670
CA-12M2N8A8502	1620015	94	CA-17F1N8A8502S	1619464	92	CA-17S1N8A8008	1619637	79	CES-LRG-BK-26	0801643	670
CA-12M2N8A8502S	1619467	92	CA-17F1N8A8503	1619614	93	CA-17S1N8A8008S	1619481	78	CES-LRG-BK-27	0801644	670
CA-12M2N8A8503	1619617	93	CA-17F1N8A8503S	1619458	92	CA-17S1N8A800DN	1619754	79	CES-LRG-BK-28	0801646	670
CA-12M2N8A8503S	1619461	92	CA-17F1N8A8504	1619608	93	CA-17S1N8A800DNS	1619583	78	CES-LRG-BK-29	0801648	670
CA-12M2N8A8504	1619611	93	CA-17F1N8A8504S	1619452	92	CA-17S1N8A9006	1620123	80	CES-LRG-BK-30	0801650	670
CA-12M2N8A8504S	1619455	92	CA-17F1N8A85DU	1619629	93	CA-17S1N8A9006S	1620050	80	CES-LRG-BK-31	0801653	670
CA-12M2N8A85DU	1619632	93	CA-17F1N8A85DUS	1619470	92	CA-17S1N8A9008	1620022	80	CES-LRG-BK-32	0801654	670
CA-12M2N8A85DUS	1619473	92	CA-17F1N8A9502	1620007	94	CA-17S1N8A900DN	1620149	80	CES-LRG-BK-33	0801656	670
CA-12M2N8A9502	1620010	94	CA-17F1N8A9503	1620001	94	CA-17S1N8AHZ00	1619780	85	CES-LTPG-GY	0801716	672
CA-12M2N8A9503	1620004	94	CA-17F1N8A9504	1619995	94	CA-19P1N122S00	1619956	83	CES-LTPG-GY-15	0801687	672
CA-12M2N8A9504	1619998	94	CA-17F1N8A95DU	1620014	94	CA-19P1N126Y00	1619852	82	CES-LTPG-GY-16	0801688	672
CA-12M2N8A9504S	1620017	94	CA-17M1N8A8502	1619619	93	CA-19P1N126Z00	1619878	81	CES-LTPG-GY-17	0801689	672
CA-12P1N122S00	1619968	83	CA-17M1N8A8502S	1619463	92	CA-19P1N128006	1619725	79	CES-LTPG-GY-18	0801690	672
CA-12P1N126Y00	1619864	82	CA-17M1N8A8503	1619613	93	CA-19P1N128006S	1619536	78	CES-LTPG-GY-19	0801691	672
CA-12P1N126Z00	1619890	81	CA-17M1N8A8503S	1619457	92	CA-19P1N128007	1619660	79	CES-LTPG-GY-20	0801692	672
CA-12P1N128006	1619737	79	CA-17M1N8A8504	1619607	93	CA-19P1N128007S	1619509	78	CES-LTPG-GY-21	0801693	672
CA-12P1N128006S	1619548	78	CA-17M1N8A8504S	1619451	92	CA-19P1N128008	1619634	79	CES-LTPG-GY-22	0801695	672
CA-12P1N128007	1619709	79	CA-17M1N8A85DU	1619628	93	CA-19P1N128008S	1619478	78	CES-LTPG-GY-23	0801696	672
CA-12P1N128007S	1619890	81	CA-17M1N8A85DUS	1619469	92	CA-19P1N12800DN	1619751	79	CES-LTPG-GY-24	0801697	672
CA-12P1N128008	1619646	79	CA-17M1N8A8504S	1619607	93	CA-19P1N12800DNS	1619580	78	CES-LTPG-GY-25	0801698	672
CA-12P1N128008S	1619495	78	CA-17M1N8A8504S	1619451	92	CA-19P1N129006	1620120	80	CES-LTPG-GY-26	0801699	672
CA-12P1N12800DN	1619763	79	CA-17M1N8A85DU	1619994	94	CA-19P1N129007	1620047	80	CES-LTPG-GY-27	0801700	672
CA-12P1N12800DNS	1619592	78	CA-17M1N8A95DU	1620013	94	CA-19P1N129008	1620019	80	CES-LTPG-GY-28	0801701	672
CA-12P1N129006	1620132										

Index

Alphabetical

Type	Order No.	Page	Type	Order No.	Page	Type	Order No.	Page	Type	Order No.	Page
CES-SRG-BK	0801670	670	CK1,6-ED-1,00ST AU	1674888	487	CUC-IND-C1ZNI-S/R4QP8:30	1406352	361	DC-PCB-M3X20	1602407	659
CES-SRG-BK-10	0801620	670	CK1,6-ED-1,50BU AG	1663433	487	CUC-IND-C1ZNI-T/R4QE8	1406339	361			
CES-SRG-BK-11	0801618	670	CK1,6-ED-1,50BU AU	1674930	487	CUC-IND-C1ZNI-T/R4QE8:30	1406357	361			
CES-SRG-BK-12	0801617	670	CK1,6-ED-1,50ST AG	1663378	487	CUC-IND-C1ZNI-T/R4QP8	1406340	361			
CES-SRG-BK-13	0801616	670	CK1,6-ED-1,50ST AU	1674875	487	CUC-IND-C1ZNI-T/R4QP8:30	1406358	361			
CES-SRG-BK-14	0801615	670	CK1,6-ED-2,50BU AG	1663446	487	CUC-PP-FRAME-19	1407986	378			
CES-SRG-BK-15	1410563	670	CK1,6-ED-2,50BU AU	1674985	559	CUC-PP-FRAME-19 BK	1409140	378			
CES-SRG-BK-16	1410576	670	CK1,6-ED-2,50ST AG	1663381	487	CUC-PP-FRAME-SCREWSSET	1407989	378			
CES-SRG-BK-17	1410589	670	CK1,6-ED-2,50ST AU	1674927	559	CUC-PP-MODUL-CABLEFIXSET	1407991	378	E	0201155	658
CES-SRG-BK-1ASH-L	1410042	671	CK1,6-ED-BB	1645888	639	CUC-PP-MODUL-COVER	1407988	378	EMPL (13X9)R	0819453	460
CES-SRG-BK-1ASH-R	0801667	671	CK1,6-ED-BU-POF	1885004	634	CUC-PP-MODUL-RJ45:6-RJ45:6/...	1407995	378	ENLAR-M-KV-M16/M20	1647653	696
CES-SRG-BK-2	0801635	670	CK1,6-ED-ST-POF	1884995	634	CUC-PP-PATCHBAY	1407994	378	ENLAR-M-KV-M20/M25	1647666	696
CES-SRG-BK-2ASH-LL	1410055	671	CK1,6/2,5-MWZ	1676734	635	CUC-V04-BU-180	1407409	334	ENLAR-M-KV-M25/M32	1647679	696
CES-SRG-BK-2ASH-LR	0801669	671	CK2,5-ED-0,50BU AG	1663640	489	CUC-V04-BU-90	1407408	334	ENLAR-M-KV-M32/M40	1647682	696
CES-SRG-BK-2ASH-RR	0801668	671	CK2,5-ED-0,50BU AU	1674859	495	CUC-V04-F-BU/RJ45	1407412	334	EV-GBM3C-1AC16A-5,0M2,5ESOG00	1408166	719
CES-SRG-BK-2X3	1410396	671	CK2,5-ED-0,50ST AG	1663572	489	CUC-V04-F-POBK-180	1407410	334	EV-GBM3C-1AC32A-5,0M6,0ESOG00	1408167	719
CES-SRG-BK-2X4	1410408	671	CK2,5-ED-0,50ST AU	1674804	495	CUC-V04-F-POBK-90	1407411	334	EV-GBM3C-3AC32A-5,0M6,0ESOG00	1408168	719
CES-SRG-BK-2X5	0801657	671	CK2,5-ED-0,5BU CUNI	1585757	634	CUC-V04-RJ45-POBK-8	1407413	334	EV-GBM4C-DC250A-5,0M7,0ESOG00	1408170	724
CES-SRG-BK-2X6	0801664	671	CK2,5-ED-0,5BU FE	1585773	634	CUC-V06-F1PGY-UBA/UBBB	1411904	439	EV-GBM3PC-1AC32A-5,0M6,0ESOG00	1408163	724
CES-SRG-BK-2X7	1410084	671	CK2,5-ED-0,5ST CUNI	1585744	634	CUC-V06-F1PGY-UBB/UBAB	1411905	439	EV-GBM3PC-3AC32A-5,0M6,0ESOG00	1408165	724
CES-SRG-BK-2X8	1410097	671	CK2,5-ED-0,5ST FE	1585760	634	CUC-V14-C1ZNI-B/R4IE8	1408011	345	EV-GBM3S-1AC32A-0,7M6,0E00	1408169	726
CES-SRG-BK-2X9	0801641	671	CK2,5-ED-0,75BU AG	1663653	489	CUC-V14-C1ZNI-B/R4IE8:10	1467804	345	EV-GBM3PC-3AC32A-0,7M6,0E00	1408170	726
CES-SRG-BK-3	0801633	670	CK2,5-ED-0,75ST AG	1663585	489	CUC-V14-C1ZNI-B/R4IP8	1407895	345	EV-GBM3SE12-1AC32A-0,7M6,0E10	1408171	726
CES-SRG-BK-4	0801632	670	CK2,5-ED-1,00BU AG	1663666	489	CUC-V14-C1ZNI-B/R4IP8:10	1408046	345	EV-GBM3SE12-3AC32A-0,7M6,0E10	1408172	726
CES-SRG-BK-4X3	0801665	671	CK2,5-ED-1,00BU AU	1674833	495	CUC-V14-C1ZNI-S/R4IE8	1407890	344	EV-GBM4C-DC125A-5,0M5,0ESBK00	1622119	717
CES-SRG-BK-4X4	0801666	671	CK2,5-ED-1,00ST AG	1663598	489	CUC-V14-C1ZNI-S/R4IE8:10	1467901	344	EV-GBM3C-3AC32A-0,7M6,0E00	1408170	726
CES-SRG-BK-4X5	1410107	671	CK2,5-ED-1,00ST AU	1674781	495	CUC-V14-C1ZNI-S/R4IP8	1407889	344	EV-GBM4C-DC60A-5,0M16ESBK00	1621468	717
CES-SRG-BK-4X6	1410152	671	CK2,5-ED-1,00ST-S AG	1663857	537	CUC-V14-C1ZNI-S/R4IP8:10	1408039	344	EV-ICCPD-T1C-EU-S-13A1-A-GEN2	1621797	725
CES-SRG-BK-5	0801630	670	CK2,5-ED-1,50BU AG	1663679	489	CUC-V14-C1ZNI-T/R4IE8	1468007	344	EV-ICCPD-T2C-EU-S-13A1-A	1621516	725
CES-SRG-BK-6	0801628	670	CK2,5-ED-1,50BU AU	1674820	495	CUC-V14-C1ZNI-T/R4IE8:10	1467807	344	EV-ICCPD-WB	1622474	725
CES-SRG-BK-7	0801627	670	CK2,5-ED-1,50ST AG	1663608	489	CUC-V14-C1ZNI-T/R4IP8	1408027	344	EV-T1L2C-1AC16A-4,0M14ASBK00	1621484	718
CES-SRG-BK-8	0801625	670	CK2,5-ED-1,50ST AU	1674778	495	CUC-V14-C1ZNI-T/R4IP8:10	1408092	344	EV-T1L2C-1AC30A-4,0M10ASBK00	1409949	718
CES-SRG-BK-9	0801622	670	CK2,5-ED-1,50ST-S AG	1663860	537	CUTFOX-ES	1212621	371	EV-T1L2CC-DC125A-5,0M1ASBK00	1409950	716
CES-STPG-GY	0801715	672	CK2,5-ED-2,50BU AG	1663682	489	CUTFOX-SCRJ-POF	1405247	372	EV-T1L2CC-DC60A-5,0M6ASBK00	1621488	716
CES-STPG-GY-10	0801682	672	CK2,5-ED-2,50BU AU	1674862	495				EV-T1M3C-1AC20A-4,0M2,5EHBK00	1621670	718
CES-STPG-GY-11	0801683	672	CK2,5-ED-2,50ST AG	1663611	489				EV-T1M3C-1AC20A-4,0M2,5ESBK00	1621482	718
CES-STPG-GY-12	0801684	672	CK2,5-ED-2,50ST AU	1674817	495				EV-T1M3C-1AC32A-4,0M6,0EHBK00	1621794	718
CES-STPG-GY-13	0801685	672	CK2,5-ED-2,50ST-S AG	1663873	537				EV-T1M3C-1AC32A-4,0M6,0ESBK00	1409952	718
CES-STPG-GY-14	0801686	672	CK2,5-ED-4,00BU AG	1663705	489				EV-T2M3C-1AC20A-4,0M2,5EHBK00	1405195	720
CES-STPG-GY-15	1410521	672	CK2,5-ED-4,00BU AU	1674846	495				EV-T2M3C-1AC20A-4,0M2,5ESBK00	1405194	721
CES-STPG-GY-16	1410534	672	CK2,5-ED-4,00ST AG	1663637	489	DC-B 6-MHR-A3	1581287	663	EV-T2M3C-1AC20A-4,0M2,5ESBK00	1409319	720
CES-STPG-GY-17	1410547	672	CK2,5-ED-4,00ST AU	1674794	495	DC-B 6-MHR-T3	1581285	663	EV-T2M3C-1AC20A-4,0M2,5ESRD00	1408274	721
CES-STPG-GY-1ASH-L	1410068	673	CK2,5-ED-BB	1584693	639	DC-B 6-A-HB-G	1602339	665	EV-T2M3C-1AC32A-4,0M6,0EHBK00	1622042	720
CES-STPG-GY-1ASH-R	0801712	673	CK2,5-EWZ	1662722	636	DC-B 6-A-HD-G	1602326	665	EV-T2M3C-1AC32A-4,0M6,0ESBK00	1405198	720
CES-STPG-GY-2	0801672	672	CK4,0-ED-1,50BU AG	1663271	547	DC-B 6-A-SA	1602313	664	EV-T2M3C-3AC20A-4,0M2,5EHBK00	1405197	720
CES-STPG-GY-2ASH-LL	1410071	673	CK4,0-ED-1,50ST AG	1663239	547	DC-B 6-ADP-4M12-FS-5CON-7X4-UT	1581010	664	EV-T2M3C-3AC20A-4,0M2,5ESBK00	1409320	720
CES-STPG-GY-2ASH-LR	0801714	673	CK4,0-ED-10,00BU AG	1586183	547	DC-B 6-CT-M	1602025	660	EV-T2M3C-3AC32A-4,0M6,0EHBK00	1410088	720
CES-STPG-GY-2ASH-RR	0801713	673	CK4,0-ED-10,00ST AG	1586198	547	DC-B 6-CT-P	1581078	665	EV-T2M3C-3AC32A-4,0M6,0ESBK00	1405199	720
CES-STPG-GY-2X3	1410424	673	CK4,0-ED-2,50BU AG	1663284	547	DC-B 6-H-80/O1STM20G-M	1581173	662	EV-T2M3PC-1AC20A-4,0M2,5EHBK00	1405192	723
CES-STPG-GY-2X4	1410438	673	CK4,0-ED-2,50ST AG	1663242	547	DC-B 6-H-80/O1STM20S-M	1581117	662	EV-T2M3PC-1AC20A-4,0M2,5EHRD00	1404563	723
CES-STPG-GY-2X5	0801708	673	CK4,0-ED-4,00BU AG	1663297	547	DC-B 6-H-80/O1STM25G-M	1581194	662	EV-T2M3PC-1AC20A-4,0M2,5ESBK00	1405193	723
CES-STPG-GY-2X6	0801709	673	CK4,0-ED-4,00ST AG	1663255	547	DC-B 6-H-80/O1STM25S-M	1581138	662	EV-T2M3PC-1AC20A-4,0M2,5ESRD00	1404876	723
CES-STPG-GY-2X7	1410110	673	CK4,0-ED-6,00BU AG	1663307	547	DC-B 6-H-80/O1STM32G-M	1581215	662	EV-T2M3PC-1AC32A-4,0M6,0ESBK00	1404568	723
CES-STPG-GY-2X8	1410123	673	CK4,0-ED-6,00ST AG	1663268	547	DC-B 6-H-80/O1STM32S-M	1581159	662	EV-T2M3PC-3AC20A-4,0M2,5EHBK00	1404567	723
CES-STPG-GY-2X9	1410440	673	CK4,0-EWZ	1662735	636	DC-B 6-H-80/O2STM20G-M	1581180	662	EV-T2M3PC-3AC20A-4,0M2,5ESBK00	1404877	723
CES-STPG-GY-3	0801673	672	CP-HC	1686478	638	DC-B 6-H-80/O2STM20S-M	1581124	662	EV-T2M3PC-3AC32A-4,0M6,0EHBK00	1622495	723
CES-STPG-GY-4	0801674	672	CP-HC-S	1410916	638	DC-B 6-H-80/O2STM25G-M	1581201	662	EV-T2M3PC-3AC32A-4,0M6,0ESBK00	1404569	723
CES-STPG-GY-4X3	0801710	673	CP-QPD	1582459	468	DC-B 6-H-80/O2STM25S-M	1581145	662	EV-T2M3SE12-3AC20A-0,7M2,5E10	1405213	727
CES-STPG-GY-4X4	0801711	673	CP-QPD 3/4X1,5	1414729	460	DC-B 6-HB-M	1602038	660	EV-T2M3SE12-3AC32A-0,7M6,0E10	1405214	727
CES-STPG-GY-4X5	1410136	673	CP-QPD 5X1,5	1414760	460	DC-B 6-HD-M20-M	1602041	661	EV-T2M3SE24-3AC20A-0,7M2,5E10	1405215	727
CES-STPG-GY-4X6	1410149	673	CP-QPD 5X2,5	1404530	468	DC-B 6-HD-M20/M20-M	1602067	661	EV-T2M3SE24-3AC32A-0,7M6,0E10	1405216	727
CES-STPG-GY-5	0801675	672	CP-QPD 5X6,0	1411402	474	DC-B 6-HD-M25-M	1602054	661	EV-T2M4CC-DC125A-5,0M5,0ESBK00	1409060	716
CES-STPG-GY-6	0801676	672	CRIMPFOX RC 2,5	1205448	637	DC-B 6-HD-M25/M25-M	1602070	661	EV-T2M4CC-DC200A-5,0M7,0ESBK00	1621653	716
CES-STPG-GY-7	0801677	672	CRIMPFOX-1,6-ER-1,50-AT	1884843	637	DC-B 6-HM-M	1602164	661	EV-T2M4CC-DC60A-4,5M16ESBK00	1618306	716
CES-STPG-GY-8	0801679	672	CRIMPFOX-1,6/2,5-ED-4,0	1687419	635	DC-B 6-HTC-M20-M20-M	1581049	661	EV-T2SFC	1405217	727
CES-STPG-GY-9	0801680	672	CRIMPFOX-CX 4,5/2	1212094	637	DC-B 6-HTC-M25-M25-M	1581052	661	EV-T2SF	1405218	727
CK1,6-ED-0,37BU AG	1663394	487	CRIMPFOX-M	1212072	636	DC-B 6-IB-7X4-PCB-90	1602180	659	EV-TAM3PC-1AC20A-4,0M2,5EHBK00	1621669	722
CK1,6-ED-0,37BU AU	1674969	487	CRIMPFOX-M TC 10/DIE	1212076	636	DC-B 6-IB-7X4-PCB-180	1602177	659	EV-TAM3PC-1AC20A-4,0M2,5ESBK00	1621481	722
CK1,6-ED-0,37ST AG	1663336	487	CRIMPFOX-M TC 4/DIE	1212075	636	DC-B 6-IBT-7X4-UT	1581065	659	EV-TAM3PC-1AC32A-4,0M6,0ESBK00	1410090	722
CK1,6-ED-0,37ST AU	1674901	487	CRIMPFOX-TC 10	1212114	636	DC-B 6-ID-7X4-UT	1602203	658	EWR	1665075	637
CK1,6-ED-0,50BU AG	1663404	487	CRIMPFOX-TC 4	1212113	636	DC-B 6-SET-3D-M20-M-7X4-UT	1602290	657			
CK1,6-ED-0,50ST AG	1663349	487	CRIMPFOX-TC MP	1212510	41	DC-B 6-SET-3D-M25-M-7X4-UT	1602300	657			
CK1,6-ED-0,50ST AU	1672453	487	CT-WZ/A	2765505	362	DC-B 6-SET-CO-M20-M-7X4-UT	1602274	657			
CK1,6-ED-0,75BU AG	1663417	487	CUC-IND-C1Z								

Type	Order No.	Page	Type	Order No.	Page	Type	Order No.	Page	Type	Order No.	Page
FL CAT5 PATCH 10,0	2832629	375	FOC-C-LCDU-GOF-MM/10	1411298	366	FOC-PP-SB-ST:6	1411903	369	FOC-V14-C1ZNI-S/SJFH:10	1408048	354
FL CAT5 PATCH 2,0	2832289	375	FOC-C-LCDU-GOF-SM-APC	1412472	366	FOC-SC-A-LC-A-GZ01/...	1405691	400	FOC-V14-C1ZNI-S/SJFP	1407896	354
FL CAT5 PATCH 3,0	2832292	375	FOC-C-LCDU-GOF-SM-APC/10	1412479	366	FOC-SC-A-LC-A-GZ01/1	1409790	400	FOC-V14-C1ZNI-T/SJFH:10	1408047	354
FL CAT5 PATCH 5,0	2832580	375	FOC-C-LCDU-GOF-SM-PC	1411053	366	FOC-SC-A-LC-A-GZ01/2	1400639	400	FOC-V14-C1ZNI-T/SJFG	1408030	354
FL CAT5 PATCH 7,5	2832616	375	FOC-C-LCDU-GOF-SM-PC/10	1411299	366	FOC-SC-A-LC-A-GZ02/...	1405692	402	FOC-V14-C1ZNI-T/SJFG:10	1408095	354
FL CAT6 PATCH 0,3	2891181	375	FOC-C-SC-P-GOF-MM	1411296	367	FOC-SC-A-LC-A-GZ02/1	1409791	402	FOC-V14-C1ZNI-T/SJFH	1408029	354
FL CAT6 PATCH 0,5	2891288	375	FOC-C-SC-P-GOF-SM-APC	1412478	367	FOC-SC-A-LC-A-GZ02/2	1400673	402	FOC-V14-C1ZNI-T/SJFH:10	1408094	354
FL CAT6 PATCH 1,0	2891385	375	FOC-C-SC-P-GOF-SM-PC	1411297	367	FOC-SC-A-LC-A-GZ03/...	1405693	404	FOC-V14-C1ZNI-T/SJFP	1408028	354
FL CAT6 PATCH 1,5	2891482	375	FOC-C-SCDU-GOF-MM	1411292	367	FOC-SC-A-LC-A-GZ03/1	1409792	404	FOC-V14-C1ZNI-T/SJFP:10	1408093	354
FL CAT6 PATCH 10	2891877	375	FOC-C-SCDU-GOF-MM/10	1411302	367	FOC-SC-A-LC-A-GZ03/2	1400681	404			
FL CAT6 PATCH 12,5	2891369	375	FOC-C-SCDU-GOF-SM-APC	1412474	367	FOC-SC-A-SC-A-GZ01/...	1405697	400			
FL CAT6 PATCH 15,0	2891372	375	FOC-C-SCDU-GOF-SM-APC/10	1412481	367	FOC-SC-A-SC-A-GZ01/1	1409798	400			
FL CAT6 PATCH 2,0	2891589	375	FOC-C-SCDU-GOF-SM-PC	1411293	367	FOC-SC-A-SC-A-GZ02/1	1400685	400			
FL CAT6 PATCH 20,0	2891576	375	FOC-C-SCDU-GOF-SM-PC/10	1411303	367	FOC-SC-A-SC-A-GZ02/...	1405698	402			
FL CAT6 PATCH 3,0	2891686	375	FOC-C-SCDU-PCF	1411305	365	FOC-SC-A-SC-A-GZ02/1	1409799	402			
FL CAT6 PATCH 5,0	2891783	375	FOC-C-SCRJ-GOF-MM	1411290	367	FOC-SC-A-SC-A-GZ02/2	1400688	402			
FL CAT6 PATCH 7,5	2891880	375	FOC-C-SCRJ-GOF-MM/10	1411300	367	FOC-SC-A-SC-A-GZ03/...	1405699	404	G-EDSWU-M20-M66L-STES-S	1411091	700
FL COUPLER SC-DUPLEX	2901788	368	FOC-C-SCRJ-GOF-SM-APC	1412473	367	FOC-SC-A-SC-A-GZ03/1	1409801	404	G-EDSWU-M20S-S66L-STES-S	1411089	700
FL CRIMPTOOL	2744869	334	FOC-C-SCRJ-GOF-SM-APC/10	1412480	367	FOC-SC-A-SC-A-GZ03/2	1400689	404	G-EDSWU-M25-M66L-STES-S	1411093	700
FL DUST CVR BK	2891107	376	FOC-C-SCRJ-GOF-SM-PC	1411291	367	FOC-SC-A-SJ-A-GZ01/...	1405700	400	G-EDSWU-M32-L66L-STES-S	1411095	700
FL DUST CVR BN	2891301	376	FOC-C-SCRJ-GOF-SM-PC/10	1411301	367	FOC-SC-A-SJ-A-GZ01/1	1409810	400	G-EDSWU-M40-L66L-STES-S	1411099	700
FL DUST CVR BU	2891204	376	FOC-C-SCRJ-PCF	1411304	365	FOC-SC-A-SJ-A-GZ01/2	1400690	400	G-EDSWU-M50-L66L-STES-S	1411101	700
FL DUST CVR GN	2891602	376	FOC-HCS-GI-1005/M12-C/M12-C/1	1408873	329	FOC-SC-A-SJ-A-GZ02/...	1405701	402	G-EDSWU-M63-L66L-STES-S	1411103	700
FL DUST CVR GY	2891505	376	FOC-HCS-GI-1005/M12-C/M12-C/2	1408872	329	FOC-SC-A-SJ-A-GZ02/1	1409811	402	G-ESIS-M12-S68L-PEPDS-BK	1415106	697
FL DUST CVR RD	2891709	376	FOC-HCS-GI-1005/M12-C/M12-C/5	1416693	329	FOC-SC-A-SJ-A-GZ02/2	1400691	402	G-ESIS-M12-S68L-PEPDS-BL	1415114	697
FL DUST CVR VT	2891806	376	FOC-HCS-GI-1005/M12-C/SCRJ/1	1408867	329	FOC-SC-A-SJ-A-GZ03/...	1405702	404	G-ESIS-M12-S68N-NEPDS-S	1415123	698
FL DUST CVR WH	2891903	376	FOC-HCS-GI-1005/M12-C/SCRJ/2	1408866	329	FOC-SC-A-SJ-A-GZ03/1	1409812	404	G-ESIS-M16-S68L-PEPDS-BK	1415107	697
FL DUST CVR YE	2891408	376	FOC-HCS-GI-1005/M12-C/SCRJ/5	1416651	329	FOC-SC-A-SJ-A-GZ03/2	1400695	404	G-ESIS-M16-S68L-PEPDS-BL	1415116	697
FL MM PATCH COUPLER LC-LC	2700312	368	FOC-LC-A-LC-A-GZ01/...	1405688	401	FOC-SJ-A-SJ-A-GZ01/...	1405703	400	G-ESIS-M16-S68N-NEPDS-S	1415124	698
FL PATCH CCODE BK	2891194	377	FOC-LC-A-LC-A-GZ01/1	1409787	401	FOC-SJ-A-SJ-A-GZ01/1	1409813	400	G-ESIS-M20-S68L-PEPDS-BK	1415108	697
FL PATCH CCODE BN	2891495	377	FOC-LC-A-LC-A-GZ01/2	1400604	401	FOC-SJ-A-SJ-A-GZ01/2	1400697	400	G-ESIS-M20-S68L-PEPDS-BL	1415117	697
FL PATCH CCODE BU	2891291	377	FOC-LC-A-LC-A-GZ02/1	1409788	403	FOC-SJ-A-SJ-A-GZ02/...	1405704	402	G-ESIS-M20-S68N-NEPDS-S	1415125	698
FL PATCH CCODE GN	2891796	377	FOC-LC-A-LC-A-GZ02/2	1400621	403	FOC-SJ-A-SJ-A-GZ02/1	1409814	402	G-ESIS-M25-M68L-PEPDS-BK	1415109	697
FL PATCH CCODE GY	2891699	377	FOC-LC-A-LC-A-GZ03/...	1405690	405	FOC-SJ-A-SJ-A-GZ02/2	1400699	402	G-ESIS-M25-M68L-PEPDS-BL	1415118	697
FL PATCH CCODE RD	2891893	377	FOC-LC-A-LC-A-GZ03/1	1409789	405	FOC-SJ-A-SJ-A-GZ03/...	1405705	404	G-ESIS-M25-M68N-NEPDS-S	1415126	698
FL PATCH CCODE VT	2891900	377	FOC-LC-A-LC-A-GZ03/2	1400622	405	FOC-SJ-A-SJ-A-GZ03/1	1409815	404	G-ESIS-M32-M68L-NEPDS-S	1415127	698
FL PATCH CCODE YE	2891592	377	FOC-LC-A-SJ-A-GZ01/...	1405694	401	FOC-SJ-A-SJ-A-GZ03/2	1400700	404	G-ESIS-M32-M68L-PEPDS-BK	1415110	697
FL PATCH GUARD	2891424	377	FOC-LC-A-SJ-A-GZ01/1	1409793	401	FOC-ST-A-LC-A-GZ01/...	1405706	401	G-ESIS-M32-M68L-PEPDS-BL	1415119	697
FL PATCH GUARD KEY	2891521	377	FOC-LC-A-SJ-A-GZ01/2	1400682	401	FOC-ST-A-LC-A-GZ01/1	1409816	401	G-ESIS-M40-M68L-NEPDS-S	1415129	698
FL PATCH SAFE CLIP	2891246	377	FOC-LC-A-SJ-A-GZ02/...	1405695	403	FOC-ST-A-LC-A-GZ01/2	1400701	401	G-ESIS-M40-M68L-PEPDS-BK	1415111	697
FL PLUG GUARD GN	2891615	376	FOC-LC-A-SJ-A-GZ02/1	1409796	403	FOC-ST-A-LC-A-GZ02/...	1405707	403	G-ESIS-M40-M68L-PEPDS-BL	1415120	697
FL PLUG GUARD KEY	2891327	376	FOC-LC-A-SJ-A-GZ02/2	1400683	403	FOC-ST-A-LC-A-GZ02/1	1409818	403	G-ESIS-M50-L68L-NEPDS-S	1415146	698
FL PLUG GUARD RD	2891712	376	FOC-LC-A-SJ-A-GZ03/...	1405696	405	FOC-ST-A-LC-A-GZ02/2	1400702	403	G-ESIS-M50-L68L-PEPDS-BK	1415112	697
FL PLUG GUARD WH	2891819	376	FOC-LC-A-SJ-A-GZ03/1	1409797	405	FOC-ST-A-SC-A-GZ01/...	1405708	401	G-ESIS-M50-L68L-PEPDS-BL	1415121	697
FL PORT GUARD	2891220	376	FOC-LC-A-SJ-A-GZ03/2	1400684	405	FOC-ST-A-SC-A-GZ01/1	1409819	401	G-ESIS-M63-L68L-NEPDS-S	1415147	698
FL RJ45 PROTECT CAP	2832991	377	FOC-M12-BU/BU	1416677	329	FOC-ST-A-SC-A-GZ01/2	1400703	401	G-ESIS-M63-L68L-PEPDS-BK	1415113	697
FL SM PATCH 1,0 LC-LC	2989187	396	FOC-M12-LC-A-GB02/1	1408869	329	FOC-ST-A-SC-A-GZ02/...	1405709	403	G-ESIS-M63-L68L-PEPDS-BL	1415122	697
FL SM PATCH 1,0 LC-SC	2989190	397	FOC-M12-LC-A-GB02/2	1408868	329	FOC-ST-A-SC-A-GZ02/1	1409821	403	G-ESIS-M63-L68L-PEPDS-S	1415148	698
FL SM PATCH 1,0 LC-ST	2989242	397	FOC-M12-LC-A-GB02/5	1416664	329	FOC-ST-A-SC-A-GZ02/2	1400705	403	G-ESIS-M63-L68L-PEPDS-S	1415149	698
FL SM PATCH 1,0 SC-SC	2901829	397	FOC-M12-M12-GB02/1	1408875	329	FOC-ST-A-SJ-A-GZ01/...	1405710	401	G-ESIS-M63-L68L-PEPDS-S	1415163	698
FL SM PATCH 1,0 SC-ST	2901832	397	FOC-M12-M12-GB02/2	1408874	329	FOC-ST-A-SJ-A-GZ01/1	1409822	401	G-ESIS-M63-L68L-PEPDS-S	1415165	698
FL SM PATCH 1,0 ST-ST	2901836	397	FOC-M12-M12-GB02/5	1416703	329	FOC-ST-A-SJ-A-GZ01/2	1400706	401	G-ESIS-M63-L68L-PEPDS-S	1415166	698
FL SM PATCH 2,0 LC-LC	2989284	396	FOC-M12-MNNA-TC-1300	1416729	329	FOC-ST-A-SJ-A-GZ02/...	1405711	403	G-ESIS-M63-L68L-PEPDS-S	1415168	698
FL SM PATCH 2,0 LC-SC	2989297	397	FOC-M12-MNNA-TC-650	1416716	329	FOC-ST-A-SJ-A-GZ02/1	1409823	403	G-ESIS-M63-L68L-PEPDS-S	1415169	698
FL SM PATCH 2,0 LC-ST	2989349	397	FOC-M12-RS-GOF	1406423	329	FOC-ST-A-SJ-A-GZ02/2	1400711	403	G-ESIS-M63-L68L-NEPDS-S	1415170	698
FL SM PATCH 2,0 SC-SC	2901830	397	FOC-M12-RS-HCS	1406422	329	FOC-ST-A-ST-A-GZ01/...	1405712	401	G-ESS-M20-S66L-NTES-S	1411075	699
FL SM PATCH 2,0 SC-ST	2901833	397	FOC-M12-RS-POF	1406421	329	FOC-ST-A-ST-A-GZ01/1	1409824	401	G-ESS-M20-S66L-STES-S	1411076	699
FL SM PATCH 2,0 ST-ST	2901837	397	FOC-OE-OE-GB01/...	1406429	398	FOC-ST-A-ST-A-GZ01/2	1404768	401	G-ESS-M25-M66L-NTES-S	1411077	699
FL SM PATCH 5,0 LC-LC	2901826	396	FOC-OE-OE-GB02/...	1406430	398	FOC-TOOL-CERAMIC-BLADE	1407019	370	G-ESS-M25-M66L-STES-S	1411078	699
FL SM PATCH 5,0 LC-SC	2901827	397	FOC-OE-OE-GB03/...	1406431	398	FOC-TOOL-DISPENSER	1406995	370	G-ESS-M32-M66L-NTES-S	1411079	699
FL SM PATCH 5,0 LC-ST	2901828	397	FOC-OE-OE-GZ01/...	1411561	400	FOC-TOOL-FERRULECLEANER-1.25	1407032	371	G-ESS-M32-M66L-STES-S	1411080	699
FL SM PATCH 5,0 SC-SC	2901831	397	FOC-OE-OE-GZ02/...	1411563	402	FOC-TOOL-FERRULECLEANER-2.50	1407029	371	G-ESS-M40-L66L-NTES-S	1411081	699
FL SM PATCH 5,0 SC-ST	2901834	397	FOC-OE-OE-GZ03/...	1411564	404	FOC-TOOL-GOF KONF SET	1411049	373	G-ESS-M40-L66L-STES-S	1411082	699
FL SM PATCH 5,0 ST-ST	2901838	397	FOC-OE-OE-HB01/...	1406432	398	FOC-TOOL-PCF KONF SET	1411051	373	G-ESS-M50-L66L-NTES-S	1411084	699
FL SM PATCH COUPLER LC-LC	2700313	368	FOC-PN-B-1000/M12-C/M12-C/1	1408871	329	FOC-TOOL-STICKCLEANER-1.25	1407000	371	G-ESS-M50-L66L-STES-S	1411085	699
FL-PP-RJ45-LSA	2901645	363	FOC-PN-B-1000/M12-C/M12-C/2	1408870	329	FOC-TOOL-STICKCLEANER-2.50	1407002	371	G-ESS-M63-L66L-NTES-S	1411086	699
FL-PP-RJ45-SC	2901643	363	FOC-PN-B-1000/M12-C/M12-C/5	1416680	329	FOC-TOOL-STRIPPING-1HOLE-250	1407004	371	G-ESS-M63-L66L-STES-S	1411087	699
FL-PP-RJ45-SCC	2901642	363	FOC-PN-B-1000/M12-C/SCRJ/1	1408865	329	FOC-TOOL-STRIPPING-2HOLE-250	1407008	371	G-ESSWU-M20-M66L-NTES-S	1411090	700
FL-PP-RJ45/RJ45	2901646	363	FOC-PN-B-1000/M12-C/SCRJ/2	1408864	329	FOC-TOOL-STRIPPING-T-1	1407016	371	G-ESSWU-M20S-S66L-NTES-S	1411088	700
FLX ASI 3.0 DIO 4/4 M12-2A	2773474	431	FOC-PN-B-1000/M12-C/SCRJ/5	1416648	329	FOC-TOOL-STRIPPING-T-2	1407014	371	G-ESSWU-M25-M66L-NTES-S	1411092	700
FLX ASI DI 4 M12	2773429	430	FOC-POLISHINGDISC-1.25	1407024	370	FOC-V06-D1PGY-S/SJBE4	1410050	343	G-ESSWU-M32-L66L-NTES-S	1411094	700
FLX ASI DI 4 M8	2773403	429	FOC-POLISHINGDISC-2.50	1407021	370	FOC-V14-C1ZNI-B/SJFG	1407905	355	G-ESSWU-M40-L66L-NTES-S	1411097	700
FLX ASI DIO 2/2 M12-2A	2773432	431	FOC-POLISHINGFILM-AO-01.0	1407037	370	FOC-V14-C1ZNI-B/SJFH	1408056	355	G-ESSWU-M50-L66L-NTES-S	1411100	700
FLX ASI DIO 4/3 M12-2A	2773445	431	FOC-POLISHINGFILM-AO-03.0	1407039							

Index

Alphabetical

Type	Order No.	Page	Type	Order No.	Page	Type	Order No.	Page	Type	Order No.	Page
G-INB-M20-S68N-PEPDS-LG	1415174	691	G-INSEC-PG29-M68N-NNES-S	1411201	689	HC-ADV-B24-HHWH-1TTM25-EMC-AL	1414980	605	HC-B 16-ANDOCK-MOD-T	1587454	567
G-INB-M25-M68N-NEPDS-S	1415183	691	G-INSEC-PG36-L68N-NNES-S	1411202	689	HC-ADV-B24-HHWH-1TTM32-EMC-AL	1413430	605	HC-B 16-AP-GY	1660384	648
G-INB-M25-M68N-PEPDS-BK	1415180	691	G-INSEC-PG42-L68N-NNES-S	1411203	689	HC-ADV-B24-HHWH-1TTM40-EMC-AL	1413432	605	HC-B 16-APV-GY	1661121	648
G-INB-M25-M68N-PEPDS-LG	1415175	691	G-INSEC-PG48-L68N-NNES-S	1411204	689	HC-ADV-B24-HLWH-1STM25-EMC-AL	1414983	605	HC-B 16-EBUQ-2,5	1605572	525
G-INB-M32-M68N-NEPDS-S	1415184	691	G-INSEC-PG7-S68N-NNES-S	1411195	689	HC-ADV-B24-HLWH-1TTM25-EMC-AL	1414982	605	HC-B 16-EBUQ-2,5-32	1605598	525
G-INB-M32-M68N-PEPDS-BK	1415181	691	G-INSEC-PG9-S68N-NNES-S	1411196	689	HC-B 6-A-DT-PEL-F	1648351	531	HC-B 16-ESTQ-2,5	1605637	525
G-INB-M32-M68N-PEPDS-LG	1415176	691	G-INSEC-PG42-L68N-NNES-S	1415189	692	HC-B 6-A-DT-PEL-M	1648364	531	HC-B 16-ESTQ-2,5-32	1605653	525
G-INB-M40-M68N-NEPDS-S	1415185	691	G-INSEC-PG48-L68N-NNES-S	1415190	692	HC-B 6-A-DT-PER-F	1648377	531	HC-B 16-I-CT-F	1648283	525
G-INESR-M20-S68N-NEPDS-S	1415192	692	G-INSEC-PG7-S68N-NNES-S	1411195	689	HC-ADV-B24-HLWH-1TTM25-EMC-AL	1414982	605	HC-B 16-I-CT-F-32	1584923	525
G-INESR-M25-M68N-NEPDS-S	1415193	692	G-INSEC-PG9-S68N-NNES-S	1411196	689	HC-B 6-A-UT-PEL-F	1648018	529	HC-B 16-I-CT-M	1605637	525
G-INESR-M32-M68N-NEPDS-S	1415194	692	G-INSEC-PG42-L68N-NNES-S	1415189	692	HC-B 6-A-UT-PEL-M	1648024	529	HC-B 16-I-CT-M-32	1584910	525
G-INESR-M40-M68N-NEPDS-S	1415195	692	G-INSEC-PG48-L68N-NNES-S	1415190	692	HC-B 6-A-UT-PER-F	1648066	529	HC-B 16-I-PT-F	1407731	525
G-INSEC-PG13,5-S68N-NNES-S	1411187	688	G-INSEC-PG7-S68N-NNES-S	1411195	689	HC-B 6-A-UT-PER-M	1648072	529	HC-B 16-I-PT-F-32	1407733	525
G-INSEC-PG16-S68N-NNES-S	1411188	688	G-INSEC-PG9-S68N-NNES-S	1411196	689	HC-B 6-ADP/1 DSUB 9	1775457	649	HC-B 16-I-PT-M	1407732	525
G-INSEC-PG19-S68N-NNES-S	1411189	688	G-INSEC-PG42-L68N-NNES-S	1415189	692	HC-B 6-ADP/1 DSUB 15	1775473	649	HC-B 16-I-PT-M-32	1407734	525
G-INSEC-PG21-S68N-NNES-S	1411190	688	G-INSEC-PG48-L68N-NNES-S	1415190	692	HC-B 6-ADP/2 DSUB 9	1775460	649	HC-B 16-I-UT-F	1648241	525
G-INSEC-PG29-S68N-NNES-S	1411191	688	G-INSEC-PG7-S68N-NNES-S	1411195	689	HC-B 6-ADP/2 DSUB 15	1775486	649	HC-B 16-I-UT-F-32	1584884	525
G-INSEC-PG36-S68N-NNES-S	1411192	688	G-INSEC-PG9-S68N-NNES-S	1411196	689	HC-B 6-ANDOCK	1586112	641	HC-B 16-I-UT-M	1648238	525
G-INSEC-PG42-S68N-NNES-S	1411193	688	G-INSEC-PG42-L68N-NNES-S	1415189	692	HC-B 6-AP-GY	1660368	648	HC-B 16-I-UT-M-32	1584871	525
G-INSEC-PG48-S68N-NNES-S	1411194	688	G-INSEC-PG48-L68N-NNES-S	1415190	692	HC-B 6-EBUQ-2,5	1605556	521	HC-B 16-SD-FL/FS	1660151	647
G-INSEC-PG56-S68N-NNES-S	1411195	688	G-INSEC-PG7-S68N-NNES-S	1411195	689	HC-B 6-ESTQ-2,5	1605611	521	HC-B 16-SD-FLU/FS-AL	1644588	647
G-INSEC-PG63-S68N-NNES-S	1411196	688	G-INSEC-PG9-S68N-NNES-S	1411196	689	HC-B 6-I-CT-F	1648160	521	HC-B 16-SD-FQ/FS	1772599	647
G-INSEC-PG7-S68N-NNES-S	1411197	688	G-INSEC-PG42-L68N-NNES-S	1415189	692	HC-B 6-I-CT-M	1648157	521	HC-B 16-SD-FQT/FS	1687273	646
G-INSEC-PG9-S68N-NNES-S	1411198	688	G-INSEC-PG48-L68N-NNES-S	1415190	692	HC-B 6-I-UT-F	1648128	521	HC-B 16-SD-FQT/FS-AL	1647763	646
G-INSEC-M12-S68N-NNES-S	1411160	685	G-INSEC-PG7-S68N-NNES-S	1411195	689	HC-B 6-I-UT-M	1648115	521	HC-B 16-SD-FQU/FS-AL	1644591	647
G-INSEC-M12-S68N-PNES-BK	1411131	681	G-INSEC-PG9-S68N-NNES-S	1411196	689	HC-B 6-SD-FL/FS	1660180	647	HC-B 16-SD-ML/FS	1687318	646
G-INSEC-M12-S68N-PNES-GY	1411123	680	G-INSEC-PG42-L68N-NNES-S	1415189	692	HC-B 6-SD-FLU/FS-AL	1644559	647	HC-B 16-SD-MLT/FS-AL	1584525	646
G-INSEC-M16-S68N-NNES-S	1411162	685	G-INSEC-PG48-L68N-NNES-S	1415190	692	HC-B 6-SD-ML/FS	1678282	646	HC-B 16-SD-MQ/FS	1678321	646
G-INSEC-M16-S68N-PNES-BK	1411132	681	G-INSEC-PG7-S68N-NNES-S	1411195	689	HC-B 6-SD-MLT/FS-AL	1644546	646	HC-B 16-SD-MQT/FS-AL	1584554	646
G-INSEC-M16-S68N-PNES-GY	1411124	680	G-INSEC-PG9-S68N-NNES-S	1411196	689	HC-B 6-TMS-SD-IP50	1690736	570	HC-B 16-TMS-EEE-PR-DI	1409817	653
G-INSEC-M20-S68N-NNES-S	1411163	685	G-INSEC-PG42-L68N-NNES-S	1415189	692	HC-B 6-TMS-SD-IP66	1411494	570	HC-B 16-TMS-SD-IP50	1690752	590
G-INSEC-M20-S68N-PNES-BK	1411133	681	G-INSEC-PG48-L68N-NNES-S	1415190	692	HC-B 06-I-PT-F	1407728	521	HC-B 16-TMS-SD-IP66	1411517	590
G-INSEC-M20-S68N-PNES-GY	1411125	680	G-INSEC-PG7-S68N-NNES-S	1411195	689	HC-B 06-I-PT-M	1407728	521	HC-B 24-A-DT-PEL-F	1648474	531
G-INSEC-M25-M68N-NNES-S	1411165	685	G-INSEC-PG9-S68N-NNES-S	1411196	689	HC-B 10-A-DT-PEL-F	1648393	531	HC-B 24-A-DT-PEL-M	1648487	531
G-INSEC-M25-M68N-PNES-BK	1411134	681	G-INSEC-PG42-L68N-NNES-S	1415189	692	HC-B 10-A-DT-PEL-M	1648403	531	HC-B 24-A-DT-PER-F	1648490	531
G-INSEC-M25-M68N-PNES-GY	1411126	680	G-INSEC-PG48-L68N-NNES-S	1415190	692	HC-B 10-A-DT-PER-F	1648416	531	HC-B 24-A-DT-PER-M	1648500	531
G-INSEC-M32-M68N-NNES-S	1411166	685	G-INSEC-PG7-S68N-NNES-S	1411195	689	HC-B 10-A-DT-PER-M	1648429	531	HC-B 24-A-UT-PEL-F	1648054	529
G-INSEC-M32-M68N-PNES-BK	1411136	681	G-INSEC-PG9-S68N-NNES-S	1411196	689	HC-B 10-A-UT-PEL-F	1648030	529	HC-B 24-A-UT-PEL-M	1648060	529
G-INSEC-M32-M68N-PNES-GY	1411127	680	G-INSEC-PG42-L68N-NNES-S	1415189	692	HC-B 10-A-UT-PEL-M	1648036	529	HC-B 24-A-UT-PER-F	1648102	529
G-INSEC-M40-M68N-NNES-S	1411167	685	G-INSEC-PG48-L68N-NNES-S	1415190	692	HC-B 10-A-UT-PER-F	1648078	529	HC-B 24-A-UT-PER-M	1648108	529
G-INSEC-M40-M68N-PNES-BK	1411137	681	G-INSEC-PG7-S68N-NNES-S	1411195	689	HC-B 10-A-UT-PER-M	1648084	529	HC-B 24-ADP-3D 7-GY	1661448	648
G-INSEC-M40-M68N-PNES-GY	1411128	680	G-INSEC-PG9-S68N-NNES-S	1411196	689	HC-B 10-ADP/1 DSUB 25	1775499	649	HC-B 24-ADP-3RST-GY	1662175	648
G-INSEC-M50-L68L-PNES-BK	1411138	681	G-INSEC-PG42-L68N-NNES-S	1415189	692	HC-B 10-ADP/2 DSUB 25	1775509	649	HC-B 24-ADP-B 6-GY	1660407	648
G-INSEC-M50-L68L-PNES-GY	1411129	680	G-INSEC-PG48-L68N-NNES-S	1415190	692	HC-B 10-ANDOCK	1586125	641	HC-B 24-ADP-B 10-GY	1660436	648
G-INSEC-M50-L68N-NNES-S	1411168	685	G-INSEC-PG7-S68N-NNES-S	1411195	689	HC-B 10-AP-GY	1660371	648	HC-B 24-ADP-B 16-GY	1660449	648
G-INSEC-M63-L68L-PNES-BK	1411139	681	G-INSEC-PG9-S68N-NNES-S	1411196	689	HC-B 10-EBUQ-2,5	1605569	523	HC-B 24-ANDOCK	1586141	641
G-INSEC-M63-L68L-PNES-GY	1411130	680	G-INSEC-PG42-L68N-NNES-S	1415189	692	HC-B 10-ESTQ-2,5	1605624	523	HC-B 24-ANDOCK-MOD-A	1587483	567
G-INSEC-M63-L68N-NNES-S	1411169	685	G-INSEC-PG48-L68N-NNES-S	1415190	692	HC-B 10-I-CT-F	1648225	523	HC-B 24-ANDOCK-MOD-T	1587470	567
G-INSEC-N1-M68L-PNES-BK	1411159	684	G-INSEC-PG7-S68N-NNES-S	1411195	689	HC-B 10-I-CT-M	1648212	523	HC-B 24-AP-GY	1660397	648
G-INSEC-N1-M68L-PNES-GY	1411155	683	G-INSEC-PG9-S68N-NNES-S	1411196	689	HC-B 10-I-PT-F	1407729	523	HC-B 24-APV-GY	1661037	648
G-INSEC-N1/2-S68L-PNES-BK	1411157	684	G-INSEC-PG42-L68N-NNES-S	1415189	692	HC-B 10-I-PT-M	1407730	523	HC-B 24-EBUQ-2,5	1605585	527
G-INSEC-N1/2-S68L-PNES-GY	1411153	683	G-INSEC-PG48-L68N-NNES-S	1415190	692	HC-B 10-I-UT-F	1648186	523	HC-B 24-EBUQ-2,5-48	1605608	527
G-INSEC-N3/4-M68L-PNES-BK	1411158	684	G-INSEC-PG7-S68N-NNES-S	1411195	689	HC-B 10-I-UT-M	1648173	523	HC-B 24-ESTQ-2,5	1605640	527
G-INSEC-N3/4-M68L-PNES-GY	1411154	683	G-INSEC-PG9-S68N-NNES-S	1411196	689	HC-B 10-SD-FL/FS	1660177	647	HC-B 24-ESTQ-2,5-48	1605666	527
G-INSEC-N3/8-S68L-PNES-BK	1411156	684	G-INSEC-PG42-L68N-NNES-S	1415189	692	HC-B 10-SD-FLU/FS-AL	1644562	647	HC-B 24-I-CT-F	1648348	527
G-INSEC-N3/8-S68L-PNES-GY	1411152	683	G-INSEC-PG48-L68N-NNES-S	1415190	692	HC-B 10-SD-FQ/FS	1772586	647	HC-B 24-I-CT-F-48	1584981	527
G-INSEC-NPT1-M68L-NNES-S	1411185	687	G-INSEC-PG7-S68N-NNES-S	1411195	689	HC-B 10-SD-FQT/FS	1687260	646	HC-B 24-I-CT-M	1648335	527
G-INSEC-NPT1/2-S68L-NNES-S	1411183	687	G-INSEC-PG9-S68N-NNES-S	1411196	689	HC-B 10-SD-FQT/FS-AL	1647750	646	HC-B 24-I-CT-M-48	1584978	527
G-INSEC-NPT3/4-M68L-NNES-S	1411184	687	G-INSEC-PG42-L68N-NNES-S	1415189	692	HC-B 10-SD-FQU/FS-AL	1644575	647	HC-B 24-I-PT-F	1407735	527
G-INSEC-NPT3/8-S68L-NNES-S	1411182	687	G-INSEC-PG48-L68N-NNES-S	1415190	692	HC-B 10-SD-ML/FS	1678295	646	HC-B 24-I-PT-F-48	1407737	527
G-INSEC-PG11-S68N-NNES-S	1411172	686	G-INSEC-PG7-S68N-NNES-S	1411195	689	HC-B 10-SD-MLT/FS-AL	1584512	646	HC-B 24-I-PT-M	1407736	527
G-INSEC-PG11-S68N-PNES-GY	1411142	682	G-INSEC-PG9-S68N-NNES-S	1411196	689	HC-B 10-SD-MQ/FS	1678305	646	HC-B 24-I-PT-M-48	1407738	527
G-INSEC-PG13,5-S68N-NNES-S	1411173	686	G-INSEC-PG42-L68N-NNES-S	1415189	692	HC-B 10-SD-MQT/FS-AL	1584541	646	HC-B 24-I-UT-F	1648306	527
G-INSEC-PG13,5-S68N-PNES-GY	1411143	682	G-INSEC-PG48-L68N-NNES-S	1415190	692	HC-B 10-TMS-EEE-PR-DI	1409804	653	HC-B 24-I-UT-F-48	1584949	527
G-INSEC-PG16-S68N-NNES-S	1411174	686	G-INSEC-PG7-S68N-NNES-S	1411195	689	HC-B 10-TMS-SD-IP50	1690749	576	HC-B 24-I-UT-M	1648296	527
G-INSEC-PG16-S68N-PNES-GY	1411144	682	G-INSEC-PG9-S68N-NNES-S	1411196	689	HC-B 10-TMS-SD-IP66	1411504	576	HC-B 24-UT-M-48	1584936	527
G-INSEC-PG21-M68N-NNES-S	1411175	686	G-INSEC-PG42-L68N-NNES-S	1415189	692	HC-B 16-A-DT-PEL-F	1648432	531	HC-B 24-SD-FL/FS	1660148	647
G-INSEC-PG21-M68N-PNES-GY	1411145	682	G-INSEC-PG48-L68N-NNES-S	1415190	692	HC-B 16-A-DT-PEL-M	1648445	531	HC-B 24-SD-FLU/FS-AL	1644601	647
G-INSEC-PG29-M68N-NNES-S	1411176	686	G-INSEC-PG7-S68N-NNES-S	1411195	689	HC-B 16-A-DT-PER-F	1648458	531	HC-B 24-SD-FQ/FS	1772609	647
G-INSEC-PG29-M68N-PNES-GY	1411146	682	G-INSEC-PG9-S68N-NNES-S	1411196	689	HC-B 16-A-DT-PER-M	1648461	531	HC-B 24-SD-FQT/FS	1687286	646
G-INSEC-PG36-L68N-NNES-S	1411178	686	G-INSEC-PG42-L68N-NNES-S	1415189	692	HC-B 16-A-UT-PEL-F	1648042	529	HC-B 24-SD-FQT/FS-AL	1647776	646
G-INSEC-PG36-L68N-PNES-GY	1411147	682	G-INSEC-PG48-L68N-NNES-S	1415190	692	HC-B 16-A-UT-PEL-M	1648048	529	HC-B 24-SD-FQU/FS-AL	1644614	647
G-INSEC-PG42-L68N-NNES-S	1411179	686	G-INSEC-PG7-S68N-N								

Index

Alphabetical

Type	Order No.	Page	Type	Order No.	Page	Type	Order No.	Page	Type	Order No.	Page
HC-D 50-SD-FQ/FS	1660193	511	HC-EVO-B06-HLFS-EL-AL	1411448	573	HC-EVO-D15-BWS-PLR-BK	1411336	504	HC-KDT 3-4	1644038	678
HC-D 50-SMQ-81/O1M25	1604908	511	HC-EVO-B06-HLFS-PLBK	1407619	572	HC-EVO-D15-BWSC-PLR-BK	1411337	504	HC-KDT 4-5	1644041	678
HC-D 50-SMQ-76/O1M32	1604909	511	HC-EVO-B06-SHWS-2SSM32-PLR-BK	1407623	572	HC-EVO-D15-CHWS-PLR-BK	1411338	504	HC-KDT 5-6	1644054	678
HC-D 50-SMQ-81/O2M25	1416383	511	HC-EVO-B06-SHWS-2SSM32-PLR-BK	1407624	572	HC-EVO-D15-HHFS-PLR-BK	1411340	502	HC-KDT 6-7	1644067	678
HC-D 50-SMQ-81/O2M32	1604910	511	HC-EVO-B06PT-BWSC-HL-M20-PLR-BK	1407710	622	HC-EVO-D15-SLWS-2SSM25-PLR-BK	1411341	504	HC-KDT 7-8	1644070	678
HC-D 50-TFQ-76/O1STM25G	1645192	510	HC-EVO-B06PT-BWSC-HL-M20ELC-AL	1411487	623	HC-EVO-D15-SLWS-2SSM25-PLR-BK	1411343	504	HC-KDT 8-9	1644083	678
HC-D 50-TFQ-76/O1STM25S	1645202	510	HC-EVO-B10-BFDC-PLR-BK	1407635	586	HC-EVO-D25-BWS-PLR-BK	1411344	508	HC-KDT 9-10	1644093	678
HC-D 50-TFQ-76/O1STM32G	1645215	510	HC-EVO-B10-BWD-PLR-BK	1407634	582	HC-EVO-D25-BWSC-PLR-BK	1411345	508	HC-KDT 10-11	1644106	678
HC-D 50-TFQ-76/O1STM32S	1645286	510	HC-EVO-B10-BWS-PLR-BK	1407632	578	HC-EVO-D25-CHWS-PLR-BK	1411346	508	HC-KDT 11-12	1644119	678
HC-D 64-A-TWIN-PEL-F	1580189	517	HC-EVO-B10-BWSC-PLR-BK	1407633	578	HC-EVO-D25-HHFS-PLR-BK	1411347	506	HC-KDT 12-13	1644122	678
HC-D 64-A-TWIN-PEL-M	1580192	517	HC-EVO-B10-CHWD-ELC-AL	1411458	583	HC-EVO-D25-SLWS-2SSM25-PLR-BK	1411348	508	HC-KDT 13-14	1644135	678
HC-D 64-A-TWIN-PER-F	1580202	517	HC-EVO-B10-CHWS-ELC-AL	1411459	579	HC-EVO-D25-SLWS-2SSM25-PLR-BK	1411349	508	HC-KDT 14-15	1644148	678
HC-D 64-A-TWIN-PER-M	1580215	517	HC-EVO-B10-CHWS-PLR-BK	1407640	578	HC-HPR-B06-BFH-EMR-BK	1411122	626	HC-KDT 15-16	1644151	678
HC-D 64-A-UT-PEL-F	1584295	515	HC-EVO-B10-HHFD-2B-PL-BK	1411495	582	HC-HPR-B06-HHWH-1STM20-EM-BK	1411878	626	HC-M-02-HS-70/16-MOD-BU	1585715	553
HC-D 64-A-UT-PEL-M	1584282	515	HC-EVO-B10-HHFD-EL-AL	1411451	583	HC-HPR-B06-HHWH-1STM25-EM-BK	1411119	626	HC-M-02-HS-70/16-MOD-ST	1585702	553
HC-D 64-A-UT-PER-F	1584321	515	HC-EVO-B10-HHFD-PLBK	1407629	582	HC-HPR-B06-HHWH-1TTM20-EM-BK	1411879	626	HC-M-02-HS-70/22-MOD-BU	1585731	553
HC-D 64-A-UT-PER-M	1584318	515	HC-EVO-B10-HHFS-EL-AL	1411453	579	HC-HPR-B06-HHWH-1TTM25-EM-BK	1411106	626	HC-M-02-HS-70/22-MOD-ST	1585728	553
HC-D 64-I-CT-F	1584444	513	HC-EVO-B10-HHFS-PLBK	1407630	578	HC-HPR-B06-SHFH-2SSM32-EMR-BK	1411880	626	HC-M-03-MOD-BUC	1679359	553
HC-D 64-I-CT-M	1584431	513	HC-EVO-B10-HHWD-EL-AL	1411454	587	HC-HPR-B06-SHFH-2SSM25-EMR-BK	1411135	626	HC-M-02-MOD-BUC	1587519	555
HC-D 7-AML-24/GR/PA BK	1413112	492	HC-EVO-B10-HHWD-PLBK	1407631	586	HC-HPR-B10-BFH-EMR-BK	1411083	627	HC-M-02-MOD-ST	1679346	553
HC-D 7-TFL-48/O1M20S/PA BK	1413510	490	HC-EVO-B10-HLFD-EL-AL	1411455	583	HC-HPR-B10-HHWH-1STM25EM-BK	1411881	627	HC-M-02-MOD-STC	1587506	555
HC-D BUC 1,5	1772544	487	HC-EVO-B10-HLFD-PLBK	1407628	582	HC-HPR-B10-HHWH-1TTM32-EM-BK	1411070	627	HC-M-03-MOD-BUC	1645972	555
HC-D STC 1,5	1772560	487	HC-EVO-B10-HLFS-EL-AL	1411456	579	HC-HPR-B10-HHWH-1TTM25-EM-BK	1411882	627	HC-M-03-MOD-STC	1645969	555
HC-D-G-M20-PLR-BK	1411350	502	HC-EVO-B10-HLFS-PLBK	1407626	578	HC-HPR-B10-HHWH-1TTM32-EM-BK	1411067	627	HC-M-03/04-MOD-BUC	1585786	555
HC-D-G-M25-PLR-BK	1411351	502	HC-EVO-B10-HLWD-EL-AL	1411457	587	HC-HPR-B10-SHFH-2SSM25-EMR-BK	1411883	627	HC-M-03/04-MOD-STC	1585799	555
HC-D-TA-M25-PLR-BK	1411352	643	HC-EVO-B10-HLWD-PLBK	1407630	586	HC-HPR-B10-SHFH-2SSM32-EMR-BK	1411096	627	HC-M-04-BU-KOAX-50	1676802	563
HC-D-TA-NPT-3/4-PLR-BK	1411354	643	HC-EVO-B10-SHFDC-2SSM32-PLR-BK	1407639	586	HC-HPR-B16-BFH-EMR-BK	1411060	628	HC-M-04-BU-KOAX-75	1686258	563
HC-D-TA-PG16-PLR-BK	1411353	643	HC-EVO-B10-SHWD-2SSM32-PLR-BK	1407638	582	HC-HPR-B16-HHWH-1STM32-EM-BK	1411058	628	HC-M-04-MOD-BU	1676789	563
HC-D15-BC-HI-PLBK	1414673	647	HC-EVO-B10-SHWS-2SSM32-PLR-BK	1407636	578	HC-HPR-B16-HHWH-1STM40-EM-BK	1411884	628	HC-M-04-MOD-BUC	1585605	555
HC-D15-BCSFS-PRBK	1414641	647	HC-EVO-B10-SHWS-2SSM32-PLR-BK	1407637	578	HC-HPR-B16-HHWH-1TTM32-EM-BK	1411059	628	HC-M-04-MOD-ST	1676792	563
HC-D15-SG-RBK	1414669	652	HC-EVO-B10PT-BWD-HL-M25-PLR-BK	1407711	622	HC-HPR-B16-HHWH-1TTM40-EM-BK	1411885	628	HC-M-04-MOD-STC	1585618	555
HC-D15-SL-PLBK	1414667	650	HC-EVO-B10PT-BWD-HL-M25ELC-AL	1411488	623	HC-HPR-B16-SHFH-2SSM32-EMR-BK	1411054	628	HC-M-04-ST-KOAX-75	1686245	563
HC-D15-SP-RBK	1414671	652	HC-EVO-B10PT-BWSC-HL-M25-PLR-BK	1408791	622	HC-HPR-B24-BFH-EMR-BK	1411886	628	HC-M-05-MOD-BUJ	1647721	563
HC-D15-TFL-66/O1PG16G	1416384	503	HC-EVO-B10PT-BWSC-HL-M25ELC-AL	1411491	623	HC-HPR-B24-HHWH-1STM32-EM-BK	1411887	629	HC-M-05-MOD-STZ	1647718	563
HC-D15-TFL-66/O1PG21G	1416385	503	HC-EVO-B16-BFDC-PLR-BK	1407649	600	HC-HPR-B24-HHWH-1TTM32-EM-BK	1411887	629	HC-M-06-MOD-STZ	1647716	563
HC-D15-TFL-66/O1PG21S	1416386	503	HC-EVO-B16-BWD-PLR-BK	1407648	596	HC-HPR-B24-HHWH-1TTM40-EM-BK	1411061	629	HC-M-06-MOD-BU	1663459	557
HC-D25-BC-HI-PLBK	1414674	647	HC-EVO-B16-BWS-PLR-BK	1407646	592	HC-HPR-B24-HHWH-1TTM32-EM-BK	1411888	629	HC-M-06P-MOD-BU	1636460	557
HC-D25-BCSFS-PRBK	1414642	647	HC-EVO-B16-BWSC-PLR-BK	1407647	592	HC-HPR-B24-HHWH-1TTM40-EM-BK	1411062	629	HC-M-06P-MOD-ST	1636457	557
HC-D25-KML-53/O1PG16	1416393	509	HC-EVO-B16-CHWD-ELC-AL	1411463	597	HC-HPR-B24-SHFH-2SSM32-EMR-BK	1411889	629	HC-M-06P-MOD-BUC	1587726	561
HC-D25-SG-RBK	1414670	652	HC-EVO-B16-CHWD-PLR-BK	1407655	596	HC-HS 2-CP	1586280	638	HC-M-08-GBIT-MOD-BU	1587700	561
HC-D25-SL-PLBK	1414668	650	HC-EVO-B16-CHWS-ELC-AL	1411464	593	HC-HS 2-D7-EBUS	1586264	489	HC-M-08-GBIT-MOD-ST	1587690	561
HC-D25-SML-57/O1PG16	1416388	509	HC-EVO-B16-CHWS-PLR-BK	1407654	592	HC-HS 2-D7-ESTS	1586277	489	HC-M-08-GBIT-STC	1587713	561
HC-D25-SML-57/O1PG21	1416390	509	HC-EVO-B16-HHFD-2B-PL-BK	1411496	596	HC-HS-PES	1586219	640	HC-M-08-MOD-BU	1605003	557
HC-D25-SMLD-57/O2PG16	1416391	509	HC-EVO-B16-HHFD-EL-AL	1411460	597	HC-HS06-I-UT-F	1406530	543	HC-M-08-MOD-ST	1605002	557
HC-D25-SP-RBK	1414672	652	HC-EVO-B16-HHFD-PLBK	1407643	596	HC-HS06-I-UT-F 7-12	1406533	543	HC-M-12-MOD-BU	1663323	559
HC-D25-TFL-72/O1PG21G	1416387	507	HC-EVO-B16-HHFS-EL-AL	1411461	593	HC-HS06-I-UT-M	1406531	543	HC-M-12-MOD-ST	1663310	559
HC-D50-KMQ-76/O1PG29G	1416403	511	HC-EVO-B16-HHFS-PLBK	1407642	592	HC-HS06-I-UT-M 7-12	1406534	543	HC-M-17-MOD-BU	1636486	559
HC-D50-KMQ-76/O1PG29	1416404	511	HC-EVO-B16-HHWD-EL-AL	1411462	601	HC-HV03-I-CT-F	1405261	537	HC-M-17-MOD-ST	1636473	559
HC-D50-SMQ-81/O1PG21	1416398	511	HC-EVO-B16-HHWD-PLBK	1407644	600	HC-HV03-I-CT-M	1405260	537	HC-M-20-MOD-BU	1636936	557
HC-D50-SMQ-81/O1PG29	1416399	511	HC-EVO-B16-SHFDC-2SSM40-PLR-BK	1407653	600	HC-HV03-I-PT-F	1407743	537	HC-M-20-MOD-ST	1636923	557
HC-D50-SMQ-81/O2PG21	1416400	511	HC-EVO-B16-SHWD-2SSM40-PLR-BK	1407652	596	HC-HV03-I-PT-M	1407739	537	HC-M-25-MOD-BU	1605005	561
HC-D50-SMQ-81/O2PG29	1416401	511	HC-EVO-B16-SHWS-2SSM40-PLR-BK	1407650	592	HC-HV06-I-CT-F	1405263	539	HC-M-25-MOD-ST	1605004	561
HC-D50-TFQ-76/O1PG21G	1416394	510	HC-EVO-B16-SHWS-2SSM40-PLR-BK	1407651	592	HC-HV06-I-CT-M	1405262	539	HC-M-BM	1676828	695
HC-D50-TFQ-76/O1PG21S	1416396	510	HC-EVO-B16PT-BWD-HH-M25-PLR-BK	1407712	622	HC-HV06-I-PT-F	1407744	539	HC-M-BS-M16	1646227	695
HC-D50-TFQ-76/O1PG29G	1416395	510	HC-EVO-B16PT-BWD-HH-M25ELC-AL	1411489	623	HC-HV06-I-PT-M	1407740	539	HC-M-BS-M20	1645846	695
HC-D50-TFQ-76/O1PG29S	1416397	510	HC-EVO-B16PT-BWSC-HH-M25-PLR-BK	1408793	622	HC-HV10-I-CT-F	1405265	541	HC-M-BS-M25	1645859	695
HC-D7-SML-26/O1STPG11	1416406	493	HC-EVO-B16PT-BWSC-HH-M25ELC-AL	1411492	623	HC-HV10-I-CT-M	1405264	541	HC-M-BS-M32	1645862	695
HC-D7-SML-57/O1STPG11/PA	1416405	492	HC-EVO-B24-BFDC-PLR-BK	1407662	614	HC-HV10-I-PT-F	1407745	541	HC-M-BS-M40	1645875	695
HC-DD108-I-CT-F	1584130	519	HC-EVO-B24-BWD-PLR-BK	1407661	610	HC-HV10-I-PT-M	1407741	541	HC-M-DSUB 09-MOD-BU	1647543	561
HC-DD108-I-CT-F-216	1584143	519	HC-EVO-B24-BWS-PLR-BK	1407659	606	HC-K 4/0-EBUS	1679427	545	HC-M-DSUB 09-MOD-ST	1647530	561
HC-DD108-I-CT-M	1584114	519	HC-EVO-B24-CHWD-ELC-AL	1407660	606	HC-K 4/0-ESTS	1679414	545	HC-M-DSUB 09/O2T-MOD-BU	1636444	561
HC-DD108-I-CT-M-216	1584127	519	HC-EVO-B24-CHWD-PLR-BK	1407668	610	HC-K 4/8-EBUS	1679320	545	HC-M-EMV-BU-3-9.5	1636091	559
HC-DD24-I-CT-F	1584046	519	HC-EVO-B24-CHWD-PLR-BK	1407668	610	HC-K 4/8-ESTS	1679333	545	HC-M-EMV-BU-3-9.5	1636091	559
HC-DD24-I-CT-M	1584033	519	HC-EVO-B24-CHWS-ELC-AL	1411476	607	HC-K 6 PE 16 QMM F	1583869	640	HC-M-EMV-MOD-ST	1678567	559
HC-DD42-I-CT-F	1584062	519	HC-EVO-B24-CHWS-PLR-BK	1407667	606	HC-K 6 PE 16 QMM M	1583870	640	HC-M-EMV-ST/3-9.5	1636088	559
HC-DD42-I-CT-M	1584059	519	HC-EVO-B24-HHFD-2B-PL-BK	1411497	610	HC-K 6/0-EBUS	1580537	543	HC-M-HS 200/40-MOD-BU	1637171	551
HC-DD72-I-CT-F	1584091	519	HC-EVO-B24-HHFD-EL-AL	1411472	611	HC-K 6/0-ESTS	1580538	543	HC-M-HS 200/40-MOD-BU-PE	1637197	551
HC-DD72-I-CT-F-144	1584101	519	HC-EVO-B24-HHFD-PLBK	1407657	610	HC-K 6/12-EBUS	1636363	545	HC-M-HS 200/40-MOD-ST	1637168	551
HC-DD72-I-CT-M	1584075	519	HC-EVO-B24-HHFS-EL-AL	1411473	607	HC-K 6/12-ESTS	1636350	545	HC-M-HS 200/40-MOD-ST-PE	1637184	551
HC-DD72-I-CT-M-144	1584088	519	HC-EVO-B24-HHFS-PLBK	1407656	606	HC-K 6/36-EBUC	1636389	547	HC-M-HS 200/70-MOD-BU	1636897	551
HC-EVO-A10UT-BWS-HH-M20-PLR-BK	1411356	502	HC-EVO-B24-HHWD-EL-AL	1411474	615	HC-K 6/36-ESTC	1636376	547	HC-M-HS 200/70-MOD-BU-PE	1636910	551
HC-EVO-A10UT-BWSC-HH-M20-PLR-BK	1411357	502	HC-EVO-B24-HHWD-PLBK	1407658							

Type	Order No.	Page	Type	Order No.	Page	Type	Order No.	Page
HC-M-KV-M25(14-21)	1646007	690	HC-STA-B06-SLWS-2SSM25-ELC-AL	1412822	573	HC-STA-B16-SLWSC-2SSM25-ELC-AL	1412865	593
HC-M-KV-M25(1AS1)	1584020	426	HC-STA-B06-SLWS-2SSP16-ELC-AL	1412823	573	HC-STA-B16-SLWSC-2SSM32-ELC-AL	1412866	593
HC-M-KV-M25(1X10/1X11)	1580228	656	HC-STA-B06-SLWSC-2SSM20-ELC-AL	1412825	573	HC-STA-B16-SLWSC-2SSP21-ELC-AL	1412867	593
HC-M-KV-M32(19-27)	1646010	690	HC-STA-B06-SLWSC-2SSM25-ELC-AL	1412826	573	HC-STA-B16PT-BWD-LS-M25-ELCAL	1416357	625
HC-M-KV-M40(27-34)	1607729	690	HC-STA-B06-SLWSC-2SSP16-ELC-AL	1412827	573	HC-STA-B16PT-BWD-LT-M25-ELCAL	1416349	624
HC-M-KV-T-M20	1646188	693	HC-STA-B06PT-BWSC-LS-M20-ELCAL	1416353	625	HC-STA-B16PT-BWSC-LS-M25-ELCAL	1416356	625
HC-M-KV-T-M25	1646191	693	HC-STA-B06PT-BWSC-LT-M20-ELCAL	1416344	624	HC-STA-B16PT-BWSC-LT-M25-ELCAL	1416348	624
HC-M-KV-T-M32	1646201	693	HC-STA-B10-24-DL-PLBK	1412886	650	HC-STA-B24-BFDC-ELC-AL	1411332	615
HC-M-KV-Z-M20	1646146	693	HC-STA-B10-BFDC-ELC-AL	1411323	587	HC-STA-B24-BWD-ELC-AL	1411331	611
HC-M-KV-Z-M25	1646159	693	HC-STA-B10-BWD-ELC-AL	1411322	583	HC-STA-B24-BWS-ELC-AL	1411339	607
HC-M-KV-Z-M32	1646162	693	HC-STA-B10-BWS-ELC-AL	1411320	579	HC-STA-B24-BWSC-ELC-AL	1411330	607
HC-M-KV-Z-M40	1646175	693	HC-STA-B10-BWSC-ELC-AL	1411321	579	HC-STA-B24-CHWD-1TTM32-ELC-AL	1412742	613
HC-M-MHMZ	1676831	569	HC-STA-B10-CHWD-1TTM20-ELC-AL	1412578	585	HC-STA-B24-CHWD-1TTM40-ELC-AL	1412743	613
HC-M-MHOZ	1676844	569	HC-STA-B10-CHWD-1TTM25-ELC-AL	1412579	585	HC-STA-B24-CHWD-1TTP21-ELC-AL	1412744	613
HC-M-MHR-A2-N	1679281	566	HC-STA-B10-CHWD-1TTM32-ELC-AL	1412580	585	HC-STA-B24-CHWD-1TTP29-ELC-AL	1412745	613
HC-M-MHR-A3-N	1679294	566	HC-STA-B10-CHWD-1TTP16-ELC-AL	1412581	585	HC-STA-B24-CHWS-1TTM32-ELC-AL	1412746	609
HC-M-MHR-A4-N	1679304	566	HC-STA-B10-CHWD-1TTP21-ELC-AL	1412582	585	HC-STA-B24-CHWS-1TTM40-ELC-AL	1412747	609
HC-M-MHR-A6-N	1679317	566	HC-STA-B10-CHWS-1TTM25-ELC-AL	1412583	585	HC-STA-B24-CHWS-1TTP21-ELC-AL	1412752	612
HC-M-MHR-FIX	1585155	566	HC-STA-B10-CHWS-1TTM20-ELC-AL	1412584	581	HC-STA-B24-CHWS-1TTP29-ELC-AL	1412749	609
HC-M-MHR-PE16	1636981	566	HC-STA-B10-CHWS-1TTM25-ELC-AL	1412585	581	HC-STA-B24-CHWS-1TTM32-ELC-AL	1412746	609
HC-M-MHR-T2-N	1679249	566	HC-STA-B10-CHWS-1TTM32-ELC-AL	1412586	581	HC-STA-B24-HHFD-1STM40-EL-AL	1412751	612
HC-M-MHR-T3-N	1679252	566	HC-STA-B10-CHWS-1TTP21-ELC-AL	1412587	581	HC-STA-B24-HHFD-1STP21-EL-AL	1412752	612
HC-M-MHR-T4-N	1679265	566	HC-STA-B10-CHWS-1TTP21-ELC-AL	1412588	581	HC-STA-B24-HHFD-1STP29-EL-AL	1412753	612
HC-M-MHR-T6-N	1679278	566	HC-STA-B10-CHWS-1TTP29-ELC-AL	1412589	581	HC-STA-B24-HHFD-1TTM32-EL-AL	1412754	612
HC-M-PN2-6.00-BU	1676763	565	HC-STA-B10-HHFD-1STM25-EL-AL	1412592	584	HC-STA-B24-HHFD-1TTM40-EL-AL	1412099	612
HC-M-PN2-6.00-BU-V	1676776	565	HC-STA-B10-HHFD-1STM32-EL-AL	1412593	584	HC-STA-B24-HHFD-1TTP21-EL-AL	1412755	612
HC-M-PN2-6.00-ST	1676750	565	HC-STA-B10-HHFD-1STP21-EL-AL	1412594	584	HC-STA-B24-HHFD-1TTP29-EL-AL	1412756	612
HC-M-PN2-MOD-ST-BU	1674998	565	HC-STA-B10-HHFD-1STP29-EL-AL	1412595	584	HC-STA-B24-HHFS-1STM32-EL-AL	1412757	608
HC-M-PN3-1.60-BU	1663514	565	HC-STA-B10-HHFD-1STM25-EL-AL	1412596	584	HC-STA-B24-HHFS-1STM40-EL-AL	1412758	608
HC-M-PN3-1.60-BU-V	1663543	565	HC-STA-B10-HHFD-1TTM32-EL-AL	1412597	584	HC-STA-B24-HHFS-1STP21-EL-AL	1412759	608
HC-M-PN3-1.60-ST	1663488	565	HC-STA-B10-HHFD-1TTP21-EL-AL	1412598	584	HC-STA-B24-HHFS-1STP29-EL-AL	1412760	608
HC-M-PN3-3.00-BU	1663527	565	HC-STA-B10-HHFD-1TTP29-EL-AL	1412599	584	HC-STA-B24-HHFS-1TTM32-EL-AL	1412761	616
HC-M-PN3-3.00-BU-V	1663556	565	HC-STA-B10-HHFS-1STM25-EL-AL	1412600	580	HC-STA-B24-HHFS-1TTM40-EL-AL	1412098	608
HC-M-PN3-3.00-ST	1663491	565	HC-STA-B10-HHFS-1STM32-EL-AL	1412601	580	HC-STA-B24-HHFS-1TTP21-EL-AL	1412762	608
HC-M-PN3-4.00-BU	1663530	565	HC-STA-B10-HHFS-1STP21-EL-AL	1412602	580	HC-STA-B24-HHFS-1TTP29-EL-AL	1412763	608
HC-M-PN3-4.00-BU-V	1663569	565	HC-STA-B10-HHFS-1STP29-EL-AL	1412603	580	HC-STA-B24-HHWD-1STM32-EL-AL	1412764	616
HC-M-PN3-4.00-ST	1663501	565	HC-STA-B10-HHFS-1TTM25-EL-AL	1412604	580	HC-STA-B24-HHWD-1STM40-EL-AL	1412766	616
HC-M-PN3-MOD-ST-BU	1663475	565	HC-STA-B10-HHFS-1TTM32-EL-AL	1412605	580	HC-STA-B24-HHWD-1STP21-EL-AL	1412767	616
HC-M4-KOAX-EWZ	1676747	435	HC-STA-B10-HHFS-1TTP21-EL-AL	1412606	580	HC-STA-B24-HHWD-1STP29-EL-AL	1412768	616
HC-MOD-ANDOCK-USCH	1587496	567	HC-STA-B10-HHFS-1TTP29-EL-AL	1412607	580	HC-STA-B24-HHWD-1TTP32-EL-AL	1412769	616
HC-MOD-K-AFS-OPE	1408559	568	HC-STA-B10-HHWD-1STM25-EL-AL	1412608	588	HC-STA-B24-HHWD-1TTM40-EL-AL	1412770	616
HC-MOD-K-AFS-PE	1408533	568	HC-STA-B10-HHWD-1STM32-EL-AL	1412609	588	HC-STA-B24-HHWD-1TTP21-EL-AL	1412771	616
HC-MOD-K-CP	1408562	568	HC-STA-B10-HHWD-1STP21-EL-AL	1412610	588	HC-STA-B24-HHWD-1TTP29-EL-AL	1412772	616
HC-MOD-K-TMS-M1M20-G-OPE	1408546	568	HC-STA-B10-HHWD-1STP29-EL-AL	1412611	588	HC-STA-B24-HLFD-1STM25-EL-AL	1412773	612
HC-MOD-K-TMS-M1M20-G-PE	1408520	568	HC-STA-B10-HHWD-1TTM25-EL-AL	1412612	588	HC-STA-B24-HLFD-1STM32-EL-AL	1412774	612
HC-NPT-1/1-M4/M40	1687587	694	HC-STA-B10-HHWD-1TTM32-EL-AL	1412613	588	HC-STA-B24-HLFD-1STP16-EL-AL	1412775	612
HC-NPT-1/1-M32	1686863	694	HC-STA-B10-HHWD-1TTP21-EL-AL	1412614	588	HC-STA-B24-HLFD-1STP21-EL-AL	1412776	612
HC-NPT-1/2-M20	1686847	694	HC-STA-B10-HHWD-1TTP29-EL-AL	1412615	588	HC-STA-B24-HLFD-1TTM25-EL-AL	1412778	612
HC-NPT-3/4-M25	1686850	694	HC-STA-B10-HLFD-1STM20-EL-AL	1412616	584	HC-STA-B24-HLFD-1TTM32-EL-AL	1412779	612
HC-Q 12-COD	1409435	638	HC-STA-B10-HLFD-1STM25-EL-AL	1412617	584	HC-STA-B24-HLFD-1TTP16-EL-AL	1412780	612
HC-Q 12-C1-CT-F	1409419	489	HC-STA-B10-HLFD-1STP16-EL-AL	1412618	584	HC-STA-B24-HLFD-1TTP21-EL-AL	1412781	612
HC-Q 12-C1-CT-M	1409422	489	HC-STA-B10-HLFD-1STP21-EL-AL	1412619	584	HC-STA-B24-HLFD-1TTP29-EL-AL	1412782	612
HC-Q05-I-CT-F	1406537	489	HC-STA-B10-HLFD-1TTM20-EL-AL	1412620	584	HC-STA-B24-HLFS-1STM25-EL-AL	1412783	608
HC-Q05-I-CT-M	1406538	489	HC-STA-B10-HLFD-1TTM25-EL-AL	1412621	584	HC-STA-B24-HLFS-1STM32-EL-AL	1412784	608
HC-STA-B06-BWS-ELC-AL	1411318	573	HC-STA-B10-HLFD-1TTP16-EL-AL	1412622	584	HC-STA-B24-HLFS-1STP16-EL-AL	1412785	608
HC-STA-B06-BWSC-ELC-AL	1411319	573	HC-STA-B10-HLFD-1TTP21-EL-AL	1412623	584	HC-STA-B24-HLFS-1STP21-EL-AL	1412786	608
HC-STA-B06-CHWS-1TTM20-ELC-AL	1412555	575	HC-STA-B10-HLFS-1STM20-EL-AL	1412624	580	HC-STA-B24-HLFS-1TTM25-EL-AL	1412788	608
HC-STA-B06-CHWS-1TTM25-ELC-AL	1412556	575	HC-STA-B10-HLFS-1STM25-EL-AL	1412625	580	HC-STA-B24-HLFS-1TTM32-EL-AL	1412789	608
HC-STA-B06-CHWS-1TTM32-ELC-AL	1412557	575	HC-STA-B10-HLFS-1STP16-EL-AL	1412627	580	HC-STA-B24-HLFS-1TTP16-EL-AL	1412790	608
HC-STA-B06-CHWS-1TTP13-ELC-AL	1412558	575	HC-STA-B10-HLFS-1STP21-EL-AL	1412628	580	HC-STA-B24-HLFS-1TTP21-EL-AL	1412791	608
HC-STA-B06-CHWS-1TTP21-ELC-AL	1412559	575	HC-STA-B10-HLFS-1TTM20-EL-AL	1412629	580	HC-STA-B24-HLFS-1TTP29-EL-AL	1412792	608
HC-STA-B06-CHWS-1TTP29-ELC-AL	1412560	575	HC-STA-B10-HLFS-1TTM25-EL-AL	1412630	580	HC-STA-B24-HLWD-1STM25-EL-AL	1412793	616
HC-STA-B06-HHFS-1STM25-EL-AL	1412562	574	HC-STA-B10-HLFS-1TTP16-EL-AL	1412631	580	HC-STA-B24-HLWD-1STM32-EL-AL	1412795	616
HC-STA-B06-HHFS-1STM32-EL-AL	1412563	574	HC-STA-B10-HLFS-1TTP21-EL-AL	1412632	580	HC-STA-B24-HLWD-1STP16-EL-AL	1412796	616
HC-STA-B06-HHFS-1STP21-EL-AL	1412564	574	HC-STA-B10-HLWD-1STM20-EL-AL	1412633	588	HC-STA-B24-HLWD-1STP21-EL-AL	1412797	616
HC-STA-B06-HHFS-1STP29-EL-AL	1412565	574	HC-STA-B10-HLWD-1STM25-EL-AL	1412634	588	HC-STA-B24-HLWD-1TTM25-EL-AL	1412799	616
HC-STA-B06-HHFS-1TTM25-EL-AL	1412566	574	HC-STA-B10-HLWD-1STP16-EL-AL	1412635	588	HC-STA-B24-HLWD-1TTM32-EL-AL	1412800	616
HC-STA-B06-HHFS-1TTM32-EL-AL	1412567	574	HC-STA-B10-HLWD-1STP21-EL-AL	1412636	588	HC-STA-B24-HLWD-1TTP16-EL-AL	1412801	616
HC-STA-B06-HHFS-1TTP21-EL-AL	1412568	574	HC-STA-B10-HLWD-1TTM20-EL-AL	1412637	588	HC-STA-B24-HLWD-1TTP21-EL-AL	1412802	616
HC-STA-B06-HHFS-1TTP29-EL-AL	1412569	574	HC-STA-B10-HLWD-1TTM25-EL-AL	1412638	588	HC-STA-B24-HLWD-1TTP29-EL-AL	1412803	616
HC-STA-B06-HLFS-1STM20-EL-AL	1412570	574	HC-STA-B10-HLWD-1TTP16-EL-AL	1412639	588	HC-STA-B24-SL-PLBK	1412885	650
HC-STA-B06-HLFS-1STM25-EL-AL	1412571	574	HC-STA-B10-HLWD-1TTP21-EL-AL	1412640	588	HC-STA-B24-SLFD-2SSM25-ELC-AL	1412869	615
HC-STA-B06-HLFS-1STP13-EL-AL	1412572	574	HC-STA-B10-SL-PLBK	1412804	650	HC-STA-B24-SLFD-2SSM32-ELC-AL	1412870	615
HC-STA-B06-HLFS-1STP16-EL-AL	1412573	574	HC-STA-B10-SLFD-2SSM20-ELC-AL	1412830	587	HC-STA-B24-SLFD-2SSP21-ELC-AL	1412871	615
HC-STA-B06-HLFS-1TTM20-EL-AL	1412574	574	HC-STA-B10-SLFD-2SSM25-ELC-AL	1412831	587	HC-STA-B24-SLWD-2SSM25-ELC-AL	1412873	611
HC-STA-B06-HLFS-1TTM25-EL-AL	1412575	574	HC-STA-B10-SLFD-2SSP16-ELC-AL	1412832	587	HC-STA-B24-SLWD-2SSM32-ELC-AL	1412874	611
HC-STA-B06-HLFS-1TTP13-EL-AL	1412576	574	HC-STA-B10-SLWD-2SSM20-ELC-AL	1412835	583	HC-STA-B24-SLWD-2SSP21-ELC-AL	1412875	611
HC-STA-B06-HLFS-1TTP16-EL-AL	1412577	574	HC-STA-B10-SLWD-2SSM25-ELC-AL	1412836	583	HC-STA-B24-SLWD-2SSM25-ELC-AL	1412877	607
HC-STA-B06-SL-PLBK	1412591	650	HC-STA-B10-SLWD-2SSP16-ELC-AL	1412837	583	HC-STA-B24-SLWS-2SSM32-ELC-AL	1412878	607
HC-STA-B06-SLWS-2SSM20-ELC-AL	1412821	573	HC-STA-B10-SLWS-2SSM20-ELC-AL	1412839	579	HC-STA-B24-SLWS-2SSP21-ELC-AL	1412879	607
HC-STA-B10-SLWS-2SSM25-ELC-AL	1412840	579	HC-STA-B10-SLWS-2SSP16-ELC-AL	1412842	579	HC-STA-B24-SLWSC-2SSM25-ELC-AL	1412845	579
HC-STA-B10-SLWS-2SSP16-ELC-AL	1412842	579	HC-STA-B10-SLWSC-2SSP16-ELC-AL	1412846	579	HC-STA-B10PT-BWD-LS-M25-ELCAL	1416355	625
HC-STA-B10-SLWSC-2SSM20-ELC-AL	1412844	579	HC-STA-B10PT-BWD-LT-M25-ELCAL	1416346	624	HC-STA-B10PT-BWSC-LS-M25-ELCAL	1416354	625
HC-STA-B10-SLWSC-2SSM25-ELC-AL	1412845	579	HC-STA-B10PT-BWSC-LT-M25-ELCAL	1416345	624	HC-STA-B16-BFDC-ELC-AL	1411328	601
HC-STA-B10-SLWSC-2SSP16-ELC-AL	1412846	579	HC-STA-B16-BFDC-ELC-AL	1411327	597	HC-STA-B16-BWD-ELC-AL	1411327	597
HC-STA-B10-SLWSC-2SSP21-ELC-AL	1412847	579	HC-STA-B16-BWS-ELC-AL	1411324	593	HC-STA-B16-CHWD-1TTM25-ELC-AL	1411325	593
HC-STA-B10-SLWSC-2SSM25-ELC-AL	1412848	579	HC-STA-B16-CHWS-1TT					

Index

Alphabetical

Type	Order No.	Page	Type	Order No.	Page	Type	Order No.	Page	Type	Order No.	Page
HC-STA-B24-SLWSC-2SSM25-ELC-AL	1412881	607	K-5E - OE/010-C02/M23 FK	1620417	207	K-7E - OE/5,0-D06/M40 F8	1620343	211	MD-INB24-4-SZP-S	1415243	677
HC-STA-B24-SLWSC-2SSM32-ELC-AL	1412882	607	K-5E - OE/010-C03/M23 F8	1620398	207	K-7E-M17 M9/010-D00/M17 F8	1624789	205	MD-INC-1-SZP-S	1415245	677
HC-STA-B24-SLWSC-2SSP21-ELC-AL	1412883	607	K-5E - OE/010-C03/M23 FK	1620420	207	K-7E-M17 M9/010-D01/M17 F8	1619325	205	MG-INC-M16-S67L-PTES-LG	1415186	690
HC-STA-B24PT-BWD-LS-M32-ELCAL	1416359	625	K-5E - OE/010-C03/M40 F8	1620310	210	K-7E-M17 M9/2,0-D00/M17 F8	1624787	205	MG-INC-M20-S67L-PTES-LG	1415187	690
HC-STA-B24PT-BWD-LT-M32-ELCAL	1416352	624	K-5E - OE/010-C04/M40 F8	1620314	210	K-7E-M17 M9/2,0-D01/M17 F8	1619323	205	MG-INC-M25-M67L-PTES-LG	1415188	690
HC-STA-B24PT-BWSC-LS-M32-ELCAL	1416358	625	K-5E - OE/010-C05/M40 F8	1620318	210	K-7E-M17 M9/5,0-D00/M17 F8	1624788	205	MICROFOX-SP-1	1212487	334
HC-STA-B24PT-BWSC-LT-M32-ELCAL	1416351	624	K-5E - OE/010-C06/M40 F8	1620321	211	K-7E-M17 M9/5,0-D01/M17 F8	1619324	205	MSK 1	1665897	294
HC-VSH	1660083	515	K-5E - OE/2,0-C00/M17 F8	1619307	204	K-7E-M23 M9/010-D02/M23 F8	1620411	208	MSK 2	1665907	294
			K-5E - OE/2,0-C01/M17 F8	1619310	205	K-7E-M23 M9/010-D03/M23 F8	1620414	208			
			K-5E - OE/2,0-C02/M23 F8	1618957	206	K-7E-M23 M9/2,0-D02/M23 F8	1620409	208			
			K-5E - OE/2,0-C02/M23 FK	1620415	207	K-7E-M23 M9/2,0-D03/M23 F8	1620412	208			
			K-5E - OE/2,0-C03/M23 F8	1620396	207	K-7E-M23 M9/5,0-D02/M23 F8	1620410	208			
			K-5E - OE/2,0-C03/M23 FK	1620418	207	K-7E-M23 M9/5,0-D03/M23 F8	1620413	208			
			K-5E - OE/2,0-C03/M40 F8	1619329	210	K-7E-M40 M9/010-D03/M40 F8	1620384	211	NBC- 1,0-93B/FSD SCO	1407528	383
			K-5E - OE/2,0-C04/M40 F8	1620311	210	K-7E-M40 M9/010-D03/M40 F8	1620382	211	NBC- 1,0-93B/FSD SCO	1407380	389
			K-5E - OE/2,0-C05/M40 F8	1620316	210	K-7E-M40 M9/010-D04/M40 F8	1620387	211	NBC- 1,0-94B/FSD SCO	1407439	391
						K-7E-M40 M9/010-D05/M40 F8	1620392	211	NBC- 2,0-93B/FSD SCO	1407529	383
						K-7E-M40 M9/010-D06/M40 F8	1620395	211	NBC- 2,0-94B/FSD SCO	1407440	391
						K-7E-M40 M9/2,0-D04/M40 F8	1620385	211	NBC- 5,0-93B/FSD SCO	1407530	383
						K-7E-M40 M9/2,0-D05/M40 F8	1620390	211	NBC- 5,0-93E/FSD SCO	1407382	389
						K-7E-M40 M9/2,0-D06/M40 F8	1620393	211	NBC- 5,0-94B/FSD SCO	1407441	391
						K-7E-M40 M9/5,0-D03/M40 F8	1620383	211	NBC- 10,0-93B/FSD SCO	1407531	383
						K-7E-M40 M9/5,0-D04/M40 F8	1620386	211	NBC- 10,0-93E/FSD SCO	1407383	389
						K-7E-M40 M9/5,0-D05/M40 F8	1620391	211	NBC- 10,0-94B/FSD SCO	1407442	391
						K-8E-M23M8/10,0-H00/OE-C5-S	1622229	212	NBC-937/...	1408540	380
						K-8E-M23M8/10,0-H00/M23F8-C5-S	1622247	212	NBC-93B/...	1408537	380
						K-8E-M23M8/10,0-H00/OE-C5-S	1622229	212	NBC-93C/...	1408538	380
						K-8E-M23M8/10,0-H00/M23F8-C5-S	1622247	212	NBC-93E/...	1408534	381
						K-8E-M23M8/2,0-H00/OE-C5-S	1622227	212	NBC-93G/...	1408541	380
						K-8E-M23M8/5,0-H00/M23F8-C5-S	1622248	212	NBC-93R/...	1408539	380
						K-8E-M23M8/5,0-H00/OE-C5-S	1622228	212	NBC-94B/...	1408535	381
						K-8E-M23M9/10,0-H00/M23F8-C5-S	1622246	212	NBC-94C/...	1408536	381
						K-8E-M23M9/2,0-H00/M23F8-C5-S	1622244	212	NBC-FR SCO-IE/.../...	1408657	391
						K-8E-M23M9/5,0-H00/M23F8-C5-S	1622245	212	NBC-FR-R4C SCO-IE/.../...	1408655	391
						K-8E-M23MK/10,0-H00/M23FK-C5-S	1622252	212	NBC-FR-R4M SCO-IE/.../...	1408653	391
						K-8E-M23MK/10,0-H00/OE-C5-S	1622243	213	NBC-FR-R4Q SCO-IE/.../...	1408651	391
						K-8E-M23MK/2,0-H00/M23FK-C5-S	1622250	212	NBC-FR-R4R SCO-IE/.../...	1408652	391
						K-8E-M23MK/2,0-H00/OE-C5-S	1622233	213	NBC-FRD SCO-EC/.../...	1408584	385
						K-8E-M23MK/5,0-H00/M23FK-C5-S	1622251	212	NBC-FRD SCO-PN/.../...	1408615	383
						K-8E-M23MK/5,0-H00/OE-C5-S	1622234	213	NBC-FRD SCO/.../...	1408690	389
						K-8E-OE/10,0-H00/M23F8-C5-S	1622226	212	NBC-FRD-R4C SCO-EC/.../...	1408583	385
						K-8E-OE/10,0-H00/M23FK-C5-S	1622232	212	NBC-FRD-R4C SCO-PN/.../...	1408613	383
						K-8E-OE/2,0-H00/M23F8-C5-S	1622224	212	NBC-FRD-R4C SCO/.../...	1408689	389
						K-8E-OE/2,0-H00/M23FK-C5-S	1622230	212	NBC-FRD-R4ACR SCO-EC/.../...	1408582	385
						K-8E-OE/5,0-H00/M23F8-C5-S	1622225	212	NBC-FRD-R4ACR SCO-PN/.../...	1408612	383
						K-8E-OE/5,0-H00/M23FK-C5-S	1622231	212	NBC-FRD-R4M SCO/.../...	1408688	389
						KDT-ST 2	1410220	674	NBC-FS R4C SCO-IE/.../...	1408665	391
						KDT-ST 3	3063921	674	NBC-FS-R4C SCO-IE/.../...	1408664	391
						KDT-ST 4	3063934	674	NBC-FS-R4M SCO-IE/.../...	1408662	391
						KDT-ST 5	3063947	674	NBC-FS-R4Q SCO-IE/.../...	1408660	391
						KDT-ST 6	3063950	674	NBC-FS-R4R SCO-IE/.../...	1408661	391
						KDT-ST 7	3063963	674	NBC-FS-R4C SCO-IE/.../...	1408664	391
						KDT-ST 8	3063976	674	NBC-FS-R4M SCO-IE/.../...	1408662	391
						KDT-ST 9	3063989	674	NBC-FS-R4Q SCO-IE/.../...	1408660	391
						KDT-ST 10	3063992	674	NBC-FS-R4R SCO-IE/.../...	1408661	391
						KDT-ST 11	3064001	674	NBC-FS/1,0-94B/R4C SCO	1407443	391
						KDT-ST 12	3062016	674	NBC-FS/1,0-94B/R4M SCO	1407451	391
						KDT-ST 13	3062029	674	NBC-FS/1,0-94B/R4Q SCO	1407459	391
						KDT-ST 14	3062032	674	NBC-FS/1,0-94B/R4C SCO	1407455	391
						KDT-ST 15	3062045	674	NBC-FS/2,0-94B/R4C SCO	1407444	391
						KDT-ST 16	3062058	674	NBC-FS/2,0-94B/R4M SCO	1407452	391
						KDT-ST 17	3062061	674	NBC-FSD SCO/.../...	1407460	391
						KEL-EMV 16-4	3063507	674	NBC-FSD-R4C SCO-EC/.../...	1408589	385
						KEL-EMV 24-5	3063510	674	NBC-FSD-R4C SCO-PN/.../...	1408622	383
						KEL-EMV-F	3063523	674	NBC-FS/5,0-94B/R4M SCO	1407453	391
						KSK 1	1685013	294	NBC-FSD-R4C SCO-EC/.../...	1407461	391
						KV-DI-PG16-1XASI	1582462	468	NBC-FS/5,0-94B/R4C SCO	1407457	391
						KV-DI-PG16-2XASI	1582464	468	NBC-FS/10,0-94B/R4C SCO	1407446	391
									NBC-FS/10,0-94B/R4M SCO	1407454	391
									NBC-FS/10,0-94B/R4Q SCO	1407462	391
									NBC-FS/10,0-94B/R4C SCO	1407458	391
									NBC-FSD SCO-EC/.../...	1408590	385
									NBC-FSD SCO-PN/.../...	1408623	383
									NBC-FSD SCO/.../...	1408697	389
									NBC-FSD-R4C SCO-EC/.../...	1408589	385
									NBC-FSD-R4C SCO-PN/.../...	1408622	383
									NBC-FSD-R4ACR SCO/.../...	1408696	389
									NBC-FSD-R4C SCO-EC/.../...	1408587	385
									NBC-FSD-R4ACR SCO-PN/.../...	1408621	383
									NBC-FSD-R4M SCO/.../...	1408695	389

Type	Order No.	Page	Type	Order No.	Page	Type	Order No.	Page	Type	Order No.	Page
NBC-FSD-R4QC SCO-PN/...	1408618	383	NBC-MRD-R4QC SCO-PN/...	1408626	383	NBC-MSX/ 5,0-94S SCO RAIL	1415600	394	NBC-MSX/ 5,0-94S/MSX SCO RAIL	1415598	394
NBC-FSD-R4QC SCO/...	1408693	389	NBC-MRD-R4QC SCO/...	1408701	389	NBC-MSX/ 10,0-94F/R4QC SCO	1407470	393	NBC-MSX/10,0-94F/R4QC SCO	1407470	393
NBC-FSD-R4RC SCO-PN/...	1408619	383	NBC-MRD-R4RC SCO-PN/...	1408628	383	NBC-MSX/10,0-94S SCO RAIL	1415601	394	NBC-MSX/10,0-94S SCO RAIL	1415601	394
NBC-FSD-R4RC SCO/...	1408694	389	NBC-MRD-R4RC SCO/...	1408702	389	NBC-MSY SCO-EH/...	1408642	395	NBC-MSY SCO-EH/...	1408641	395
NBC-FSD/ 1,0-93B/R4AC SCO	1407532	383	NBC-MS SCO-IE/...	1408682	391	NBC-MSY/ 1,0-94H SCO	1407487	395	NBC-MSY/ 1,0-94H/MSY SCO	1407491	395
NBC-FSD/ 1,0-93B/R4ACR SCO	1407536	383	NBC-MS-FR SCO-IE/...	1408650	391	NBC-MSY/ 2,0-94H SCO	1407488	395	NBC-MSY/ 2,0-94H/MSY SCO	1407492	395
NBC-FSD/ 1,0-93B/R4QC SCO	1407548	383	NBC-MS-FS SCO-IE/...	1408659	391	NBC-MSY/ 5,0-94H SCO	1407489	395	NBC-MSY/ 5,0-94H/MSY SCO	1407493	395
NBC-FSD/ 1,0-93B/R4RC SCO	1407544	383	NBC-MS-MR SCO-IE/...	1408667	391	NBC-MSY/10,0-94H SCO	1407490	395	NBC-MSY/10,0-94H/MSY SCO	1407494	395
NBC-FSD/ 1,0-93E/R4AC SCO	1407384	389	NBC-MS-MS SCO-IE/...	1408676	391	NBC-R4AC-IE4/...	1411827	388	NBC-R4AC-IE4/...	1411827	388
NBC-FSD/ 1,0-93E/R4ACR SCO	1407388	389	NBC-MS-R4AC SCO-IE/...	1408681	391	NBC-R4AC-IE8A/...	1411853	392	NBC-R4AC-IE8A/...	1411853	392
NBC-FSD/ 1,0-93E/R4QC SCO	1407396	389	NBC-MS-R4MC SCO-IE/...	1408679	391	NBC-R4AC-IE8A/...	1411857	382	NBC-R4AC-IE8A/...	1411857	382
NBC-FSD/ 1,0-93E/R4RC SCO	1407392	389	NBC-MS-R4QC SCO-IE/...	1408677	391	NBC-R4AC-IE4/...	1411832	388	NBC-R4AC-IE4/...	1411832	388
NBC-FSD/ 2,0-93B/R4AC SCO	1407533	383	NBC-MS-R4RC SCO-IE/...	1408678	391	NBC-R4AC-IE8A/...	1411853	392	NBC-R4AC-IE8A/...	1411853	392
NBC-FSD/ 2,0-93B/R4ACR SCO	1407537	383	NBC-MS/ 1,0-94B SCO	1407404	391	NBC-R4AC-IE8A/...	1411857	382	NBC-R4AC-IE8A/...	1411857	382
NBC-FSD/ 2,0-93B/R4QC SCO	1407549	383	NBC-MS/ 1,0-94B/FS SCO	1407463	391	NBC-R4AC-IE4/...	1411827	388	NBC-R4AC-IE4/...	1411827	388
NBC-FSD/ 2,0-93B/R4RC SCO	1407545	383	NBC-MS/ 1,0-94B/MS SCO	1407434	391	NBC-R4AC-IE8A/...	1411853	392	NBC-R4AC-IE8A/...	1411853	392
NBC-FSD/ 2,0-93E/R4AC SCO	1407385	389	NBC-MS/ 1,0-94B/R4AC SCO	1407414	391	NBC-R4AC-IE8A/...	1411857	382	NBC-R4AC-IE8A/...	1411857	382
NBC-FSD/ 2,0-93E/R4ACR SCO	1407389	389	NBC-MS/ 1,0-94B/R4MC SCO	1407422	391	NBC-R4AC-IE8A/...	1411857	382	NBC-R4AC-IE8A/...	1411857	382
NBC-FSD/ 2,0-93E/R4QC SCO	1407397	389	NBC-MS/ 1,0-94B/R4QC SCO	1407430	391	NBC-R4AC-IE8A/...	1411857	382	NBC-R4AC-IE8A/...	1411857	382
NBC-FSD/ 2,0-93E/R4RC SCO	1407393	389	NBC-MS/ 1,0-94B/R4RC SCO	1407426	391	NBC-R4AC-IE8A/...	1411857	382	NBC-R4AC-IE8A/...	1411857	382
NBC-FSD/ 5,0-93B/R4AC SCO	1407534	383	NBC-MS/ 2,0-94B SCO	1407405	391	NBC-R4AC-IE8A/...	1411857	382	NBC-R4AC-IE8A/...	1411857	382
NBC-FSD/ 5,0-93B/R4ACR SCO	1407538	383	NBC-MS/ 2,0-94B/FS SCO	1407464	391	NBC-R4AC-IE8A/...	1411857	382	NBC-R4AC-IE8A/...	1411857	382
NBC-FSD/ 5,0-93B/R4QC SCO	1407551	383	NBC-MS/ 2,0-94B/MS SCO	1407435	391	NBC-R4AC-IE8A/...	1411857	382	NBC-R4AC-IE8A/...	1411857	382
NBC-FSD/ 5,0-93B/R4RC SCO	1407546	383	NBC-MS/ 2,0-94B/R4AC SCO	1407415	391	NBC-R4AC-IE8A/...	1411857	382	NBC-R4AC-IE8A/...	1411857	382
NBC-FSD/ 5,0-93E/R4AC SCO	1407386	389	NBC-MS/ 2,0-94B/R4MC SCO	1407423	391	NBC-R4AC-IE8A/...	1411857	382	NBC-R4AC-IE8A/...	1411857	382
NBC-FSD/ 5,0-93E/R4ACR SCO	1407390	389	NBC-MS/ 2,0-94B/R4QC SCO	1407431	391	NBC-R4AC-IE8A/...	1411857	382	NBC-R4AC-IE8A/...	1411857	382
NBC-FSD/ 5,0-93E/R4QC SCO	1407398	389	NBC-MS/ 2,0-94B/R4RC SCO	1407427	391	NBC-R4AC-IE8A/...	1411857	382	NBC-R4AC-IE8A/...	1411857	382
NBC-FSD/ 5,0-93E/R4RC SCO	1407394	389	NBC-MS/ 2,0-94B/MS SCO	1407406	391	NBC-R4AC-IE8A/...	1411857	382	NBC-R4AC-IE8A/...	1411857	382
NBC-FSD/10,0-93B/R4AC SCO	1407535	383	NBC-MS/ 5,0-94B/FS SCO	1407465	391	NBC-R4AC-IE8A/...	1411857	382	NBC-R4AC-IE8A/...	1411857	382
NBC-FSD/10,0-93B/R4ACR SCO	1407539	383	NBC-MS/ 5,0-94B/MS SCO	1407436	391	NBC-R4AC-IE8A/...	1411857	382	NBC-R4AC-IE8A/...	1411857	382
NBC-FSD/10,0-93B/R4QC SCO	1407552	383	NBC-MS/ 5,0-94B/R4AC SCO	1407416	391	NBC-R4AC-IE8A/...	1411857	382	NBC-R4AC-IE8A/...	1411857	382
NBC-FSD/10,0-93B/R4RC SCO	1407547	383	NBC-MS/ 5,0-94B/R4MC SCO	1407424	391	NBC-R4AC-IE8A/...	1411857	382	NBC-R4AC-IE8A/...	1411857	382
NBC-FSD/10,0-93E/R4AC SCO	1407387	389	NBC-MS/ 5,0-94B/R4QC SCO	1407432	391	NBC-R4AC-IE8A/...	1411857	382	NBC-R4AC-IE8A/...	1411857	382
NBC-FSD/10,0-93E/R4MC SCO	1407391	389	NBC-MS/ 5,0-94B/R4RC SCO	1407428	391	NBC-R4AC-IE8A/...	1411857	382	NBC-R4AC-IE8A/...	1411857	382
NBC-FSD/10,0-93E/R4QC SCO	1407399	389	NBC-MS/10,0-94B SCO	1407407	391	NBC-R4AC-IE8A/...	1411857	382	NBC-R4AC-IE8A/...	1411857	382
NBC-FSD/10,0-93E/R4RC SCO	1407395	389	NBC-MS/10,0-94B/FS SCO	1407466	391	NBC-R4AC-IE8A/...	1411857	382	NBC-R4AC-IE8A/...	1411857	382
NBC-M 8FS-R4AC/...	1408714	386	NBC-MS/10,0-94B/MS SCO	1407438	391	NBC-R4AC-IE8A/...	1411857	382	NBC-R4AC-IE8A/...	1411857	382
NBC-M 8FS/...	1408716	386	NBC-MS/10,0-94B/R4AC SCO	1407417	391	NBC-R4AC-IE8A/...	1411857	382	NBC-R4AC-IE8A/...	1411857	382
NBC-M 8MS-M 8FS/...	1408715	386	NBC-MS/10,0-94B/R4MC SCO	1407425	391	NBC-R4AC-IE8A/...	1411857	382	NBC-R4AC-IE8A/...	1411857	382
NBC-M 8MS-M 8MS/...	1408718	386	NBC-MS/10,0-94B/R4QC SCO	1407433	391	NBC-R4AC-IE8A/...	1411857	382	NBC-R4AC-IE8A/...	1411857	382
NBC-M 8MS-R4AC/...	1408717	386	NBC-MS/10,0-94B/R4RC SCO	1407429	391	NBC-R4AC-IE8A/...	1411857	382	NBC-R4AC-IE8A/...	1411857	382
NBC-M 8MS/ 1,0-93B	1407344	386	NBC-MSD SCO-EC/...	1408600	384	NBC-R4AC-IE8A/...	1411857	382	NBC-R4AC-IE8A/...	1411857	382
NBC-M 8MS/ 1,0-93B/M 8MS	1407348	386	NBC-MSD SCO-PN/...	1408604	383	NBC-R4AC-IE8A/...	1411857	382	NBC-R4AC-IE8A/...	1411857	382
NBC-M 8MS/ 1,0-93B/R4AC	1407352	386	NBC-MSD SCO-PN/...	1408713	389	NBC-R4AC-IE8A/...	1411857	382	NBC-R4AC-IE8A/...	1411857	382
NBC-M 8MS/ 2,0-93B	1407345	386	NBC-MSD-FRD SCO-EC/...	1408581	385	NBC-R4AC-IE8A/...	1411857	382	NBC-R4AC-IE8A/...	1411857	382
NBC-M 8MS/ 2,0-93B/M 8MS	1407349	386	NBC-MSD-FRD SCO-PN/...	1408608	383	NBC-R4AC-IE8A/...	1411857	382	NBC-R4AC-IE8A/...	1411857	382
NBC-M 8MS/ 2,0-93B/R4AC	1407353	386	NBC-MSD-FRD SCO/...	1408684	389	NBC-R4AC-IE8A/...	1411857	382	NBC-R4AC-IE8A/...	1411857	382
NBC-M 8MS/ 5,0-93B	1407346	386	NBC-MSD-FSD SCO-EC/...	1408586	385	NBC-R4AC-IE8A/...	1411857	382	NBC-R4AC-IE8A/...	1411857	382
NBC-M 8MS/ 5,0-93B/M 8MS	1407350	386	NBC-MSD-FSD SCO-PN/...	1408617	383	NBC-R4AC-IE8A/...	1411857	382	NBC-R4AC-IE8A/...	1411857	382
NBC-M 8MS/ 5,0-93B/R4AC	1407354	386	NBC-MSD-FSD SCO/...	1408692	389	NBC-R4AC-IE8A/...	1411857	382	NBC-R4AC-IE8A/...	1411857	382
NBC-M 8MS/...	1408719	386	NBC-MSD-MRD SCO-EC/...	1408593	385	NBC-R4AC-IE8A/...	1411857	382	NBC-R4AC-IE8A/...	1411857	382
NBC-M 8MS/10,0-93B	1407347	386	NBC-MSD-MRD SCO-PN/...	1408625	383	NBC-R4AC-IE8A/...	1411857	382	NBC-R4AC-IE8A/...	1411857	382
NBC-M 8MS/10,0-93B/M 8MS	1407351	386	NBC-MSD-MRD SCO/...	1408700	389	NBC-R4AC-IE8A/...	1411857	382	NBC-R4AC-IE8A/...	1411857	382
NBC-M 8MS/10,0-93B/R4AC	1407355	386	NBC-MSD-MSD SCO-EC/...	1408597	384	NBC-R4AC-IE8A/...	1411857	382	NBC-R4AC-IE8A/...	1411857	382
NBC-MR SCO-IE/...	1408675	391	NBC-MSD-MSD SCO-PN/...	1408634	383	NBC-R4AC-IE8A/...	1411857	382	NBC-R4AC-IE8A/...	1411857	382
NBC-MR-FR SCO-IE/...	1408649	391	NBC-MSD-MSD SCO/...	1408706	389	NBC-R4AC-IE8A/...	1411857	382	NBC-R4AC-IE8A/...	1411857	382
NBC-MR-FS SCO-IE/...	1408658	391	NBC-MSD-R4AC SCO-EC/...	1408599	384	NBC-R4AC-IE8A/...	1411857	382	NBC-R4AC-IE8A/...	1411857	382
NBC-MR-MR SCO-IE/...	1408666	391	NBC-MSD-R4AC SCO-PN/...	1408639	383	NBC-R4AC-IE8A/...	1411857	382	NBC-R4AC-IE8A/...	1411857	382
NBC-MR-R4AC SCO-IE/...	1408674	391	NBC-MSD-R4AC SCO/...	1408712	389	NBC-R4AC-IE8A/...	1411857	382	NBC-R4AC-IE8A/...	1411857	382
NBC-MR-R4MC SCO-IE/...	1408671	391	NBC-MSD-R4ACR SCO-EC/...	1408598	384	NBC-R4AC-IE8A/...	1411857	382	NBC-R4AC-IE8A/...	1411857	382
NBC-MR-R4QC SCO-IE/...	1408668	391	NBC-MSD-R4ACR SCO-PN/...	1408638	383	NBC-R4AC-IE8A/...	1411857	382	NBC-R4AC-IE8A/...	1411857	382
NBC-MRD-R4RC SCO-IE/...	1408670	391	NBC-MSD-R4MC SCO/...	1408710	389	NBC-R4AC-IE8A/...	1411857	382	NBC-R4AC-IE8A/...	1411857	382
NBC-MRD SCO-EC/...	1408596	385	NBC-MSD-R4QC SCO-PN/...	1408635	383	NBC-R4AC-IE8A/...	1411857	382	NBC-R4AC-IE8A/...	1411857	382
NBC-MRD SCO-PN/...	1408633	383	NBC-MSD-R4QC SCO/...	1408707	389	NBC-R4AC-IE8A/...	1411857	382	NBC-R4AC-IE8A/...	1411857	382
NBC-MRD-FRD SCO-EC/...	1408705	389	NBC-MSD-R4RC SCO-PN/...	1408636	383	NBC-R4AC-IE8A/...	1411857	382	NBC-R4AC-IE8A/...	1411857	382
NBC-MRD-FRD SCO-PN/...	1408580	385	NBC-MSD-R4RC SCO/...	1408709	389	NBC-R4AC-IE8A/...	1411857	382	NBC-R4AC-IE8A/...	1411857	382
NBC-MRD-FRD SCO-PN/...	1408607	383	NBC-MSD/ 1,0-93B SCO	1407495	383	NBC-R4AC-IE8A/...	1411857	382	NBC-R4AC-IE8A/...	1411857	382
NBC-MRD-FRD SCO/...	1408683	389	NBC-MSD/ 1,0-93B/FS SCO	1407553	383	NBC-R4AC-IE8A/...	1411857	382	NBC-R4AC-IE8A/...	1411857	382
NBC-MRD-FSD SCO-EC/...	1408585	385	NBC-MSD/ 1,0-93B/MS SCO	1407524	383	NBC-R4AC-IE8A/...	1411857	382	NBC-R4AC-IE8A/...	1411857	382
NBC-MRD-FSD SCO-PN/...	1408616	383	NBC-MSD/ 1,0-93E SCO	1407499	383	NBC-R4AC-IE8A/...	1411857	382	NBC-R4AC-IE8A/...	1411857	382
NBC-MRD-FSD SCO/...	1408691	389	NBC-MSD/ 1,0-93E/FS SCO	1407508	383	NBC-R4AC-IE8A/...	1411857	382	NBC-R4AC-IE8A/...	1411857	382
NBC-MRD-MRD SCO-EC/...	1408592	385	NBC-MSD/ 1,0-93E/R4QC SCO	1407520	383	NBC-R4AC-IE8A/...	1411857	382	NBC-R4AC-IE8A/...	1411857	382
NBC-MRD-MRD SCO-PN/...	1408624	383	NBC-MSD/ 1,0-93B/R4RC SCO	1407516	383	NBC-R4AC-IE8A/...	1411857	382	NBC-R4AC-IE8A/...	1411857	382
NBC-MRD-MRD SCO/...	1408699	389	NBC-MSD/ 1,0-93E SCO	1407536	389	NBC-R4AC-IE8A/...	1411857	382	NBC-R4AC-IE8A/...	1411857	382
NBC-MRD-R4AC SCO-EC/...	1408595	385	NBC-MSD/ 1,0-9								

Index

Alphabetical

Type	Order No.	Page	Type	Order No.	Page	Type	Order No.	Page	Type	Order No.	Page
NBC-R4MC/10,0-94B/R4MC	1408958	390	PSM-FO-STRIP	2744199	634	QPD H 4PE6,0 4X9-14 BK	1411422	469	QPD W 3PE1,5 8-13 M20 FC BK	1414680	458
NBC-R4MC/2,0-93E/R4MC	1408938	388	PSM-SET-B-FOC/4-HCS	2708481	364	QPD H 4PE6,0 BK	1411426	469	QPD W 3PE1,5 M20 0,5 BK	1414681	457
NBC-R4MC/2,0-94B/R4MC	1408956	390	PSM-SET-B-FOC/4-HCS/PN	2313782	365	QPD N 2,5 6-10 BK	1582226	461	QPD W 3PE1,5 M20 1,0 BK	1414682	457
NBC-R4MC/5,0-93E/R4MC	1408939	388	PSM-SET-BFOC-LINK/2	2799429	368	QPD N 2,5 9-14 BK	1582229	461	QPD W 3PE1,5 M20 FC BK	1414683	458
NBC-R4MC/5,0-94B/R4MC	1408954	390	PSM-SET-FSMA-LINK/2	2799416	368	QPD N 2PE1,5 4-9 BK	1415099	452	QPD W 3PE1,5 M25 0,1 BK K TH	1577273	476
NBC-R4QC-IE4/.....	1411830	389	PSM-SET-FSMA/4-HCS	2799487	364	QPD N 2PE1,5 8-13 BK	1415100	452	QPD W 3PE2,5 6-10 M25 0,5 BK	1582163	464
NBC-R4QC-IE8/.....	1411841	391	PSM-SET-FSMA/4-KT	2799720	364	QPD N 3PE1,5 4-9 BK	1415097	452	QPD W 3PE1,5 M20 1,0 BK	1582160	464
NBC-R4QC-IE8A/.....	1415638	393	PSM-SET-SC-DUPLEX/2-HCS/PN	2313779	365	QPD N 3PE1,5 8-13 BK	1415098	452	QPD W 3PE2,5 6-10 M25 DT BK	1582169	466
NBC-R4QC-PN4/.....	1411860	383	PT/FS 4,8	1670497	460	QPD N 4PE1,5 5-10 BK	1415101	452	QPD W 3PE2,5 6-10 M25 FC BK	1582166	465
NBC-R4QC-R4QC-IE4/.....	1411837	389				QPD N 4PE1,5 9-14 BK	1415104	452	QPD W 3PE2,5 9-14 M25 0,5 BK	1582175	464
NBC-R4QC-R4QC-IE8/.....	1411848	391				QPD N 4PE2,5 6-11 BK	1459663	461	QPD W 3PE2,5 9-14 M25 1,0 BK	1582172	464
NBC-R4QC-R4QC-IE8A/.....	1414324	393				QPD N 4PE2,5 9-16 BK	1459647	461	QPD W 3PE2,5 9-14 M25 DT BK	1582181	466
NBC-R4QC-R4QC-PN4/.....	1411867	383				QPD N 4PE6,0 12-20 BK	1410406	469	QPD W 3PE2,5 9-14 M25 FC BK	1582178	465
NBC-R4QC/1,0-93B/R4QC	1408978	383				QPD N 4PE6,0 9-14 BK	1410409	469	QPD W 3PE2,5 M25 0,5 BK	1582187	464
NBC-R4QC/1,0-93E/R4QC	1408947	389				QPD P 2PE1,5 4-9 BK	1414705	459	QPD W 3PE2,5 M25 1,0 BK	1582190	464
NBC-R4QC/1,0-94B/R4QC	1408965	391				QPD P 2PE1,5 8-13 BK	1414706	459	QPD W 3PE2,5 M25 DT BK	1582193	466
NBC-R4QC/10,0-93B/R4QC	1408980	383				QPD P 3PE1,5 4-9 BK	1414703	459	QPD W 3PE2,5 M25 FC BK	1582196	465
NBC-R4QC/10,0-93E/R4QC	1408949	389	Q 0,75/4IDC/18-18KU-KU BK	1642140	454	QPD P 3PE1,5 8-13 BK	1414704	459	QPD W 4PE1,5 9-14 M25 0,5 BK	1414730	457
NBC-R4QC/10,0-94B/R4QC	1408967	391	Q 1,5/3FL/13-M20KU-ESA-BK	1641659	456	QPD P 3PE2,5 6-10 BK	1582202	467	QPD W 4PE1,5 5-10 M25 1,0 BK	1414731	457
NBC-R4QC/2,0-93B/R4QC	1408979	383	Q 1,5/3FL/13-M20KU-ESA-BK LNPE	1641594	456	QPD P 3PE2,5 6-10 BK BK	1582637	467	QPD W 4PE1,5 5-10 M25 FC BK	1414732	458
NBC-R4QC/2,0-93E/R4QC	1408948	389				QPD P 3PE2,5 9-14 BK	1582205	467	QPD W 4PE1,5 9-14 M25 0,5 BK	1414733	457
NBC-R4QC/2,0-94B/R4QC	1408969	391				QPD P 3PE2,5 9-14 BK BK	1582638	467	QPD W 4PE2,5 5-10 M25 1,0 BK	1414734	457
NBC-R4QC/5,0-93B/R4QC	1408977	383				QPD P 4PE1,5 5-10 BK	1414749	459	QPD W 4PE1,5 9-14 M25 FC BK	1414735	458
NBC-R4QC/5,0-93E/R4QC	1408946	389				QPD P 4PE1,5 9-14 BK	1414750	459	QPD W 4PE1,5 M25 0,5 BK	1414736	457
NBC-R4QC/5,0-94B/R4QC	1408964	391				QPD P 4PE2,5 6-11 BK	1403784	467	QPD W 4PE1,5 M25 1,0 BK	1414737	457
NBC-R4RC-IE4/.....	1411829	388				QPD P 4PE2,5 9-14 BK	1403782	467	QPD W 4PE1,5 M25 FC BK	1414738	458
NBC-R4RC-IE8/.....	1411840	390				QPD P 4PE6,0 12-20 BK	1410387	473	QPD W 4PE2,5 6-11 M20 0,5 BK	1403725	464
NBC-R4RC-IE8A/.....	1415637	392				QPD P 4PE6,0 9-14 BK	1410386	473	QPD W 4PE2,5 6-11 M20 0,5 EX	1411398	475
NBC-R4RC-PN4/.....	1411859	382				QPD PSK 2,5	1582151	468	QPD W 4PE2,5 6-11 M20 1,0 BK	1403727	464
NBC-R4RC-R4RC-IE4/.....	1411836	388	Q SET-11/4 COD1 SACB-Q	1670743	296	QPD PSK 3/4X1,5	1414724	460	QPD W 4PE2,5 6-11 M20 1,0 EX	1411394	475
NBC-R4RC-R4RC-IE8/.....	1411847	390	Q-MU M16	1640692	468	QPD PSK 5X1,5	1414759	460	QPD W 4PE2,5 6-11 M20 FC BK	1403729	465
NBC-R4RC-R4RC-IE8A/.....	1414323	392	Q-MU M20	1640715	460	QPD PSK 5X2,5	1404529	468	QPD W 4PE2,5 6-11 M20 FC BK	1411398	475
NBC-R4RC-R4RC-PN4/.....	1411866	382				QPD PSK 5X6,0	1411404	468	QPD W 4PE2,5 6-11 M25 0,5 BK	1582557	464
NBC-R4RC/1,0-93B/R4RC	1408974	382				QPD QSK 2,5	1582150	468	QPD W 4PE2,5 6-11 M25 0,5 EX	1411387	475
NBC-R4RC/1,0-93E/R4RC	1408941	388				QPD QSK 2,5 FS	1582488	468	QPD W 4PE2,5 6-11 M25 1,0 BK	1582558	464
NBC-R4RC/1,0-94B/R4RC	1408961	390				QPD QSK 3/4X1,5	1414723	460	QPD W 4PE2,5 6-11 M20 0,5 EX	1411398	475
NBC-R4RC/10,0-93B/R4RC	1408976	382				QPD QSK 5X1,5	1414758	460	QPD W 4PE2,5 6-11 M25 FC BK	1582559	465
NBC-R4RC/10,0-93E/R4RC	1408945	388	QPD 5P/ 3,0-PVC/5P 5X2,5 BK	1408721	477	QPD QSK 5X2,5	1404528	468	QPD W 4PE2,5 6-11 M25 FC BK	1411389	475
NBC-R4RC/10,0-94B/R4RC	1408963	390	QPD 5P/ 5,0-PVC/5P 5X2,5 BK	1408722	477	QPD QSK 5X6,0	1411403	468	QPD W 4PE2,5 9-16 M20 0,5 BK	1403731	464
NBC-R4RC/2,0-93B/R4RC	1408975	382	QPD 5P/10,0-PVC/5P 5X2,5 BK	1408723	477	QPD QSK 5X6,0 FS	1582645	468	QPD W 4PE2,5 9-16 M20 0,5 EX	1411397	475
NBC-R4RC/2,0-93E/R4RC	1408942	388	QPD C 2PE1,5 1X8-13 BK	1414701	455	QPD QSK BK 3/4X1,5 FS	1414722	460	QPD W 4PE2,5 9-16 M20 1,0 BK	1403733	464
NBC-R4RC/2,0-94B/R4RC	1408962	390	QPD C 2PE1,5 2X4-9 BK	1414700	455	QPD QSK BK 5X1,5 FS	1414728	460	QPD W 4PE2,5 9-16 M20 1,0 EX	1411398	475
NBC-R4RC/5,0-93B/R4RC	1408972	382	QPD C 2PE1,5 2X8-13 BK	1414702	455	QPD QSK BK 5X2,5 FS	1404525	468	QPD W 4PE2,5 9-16 M20 FC BK	1403735	465
NBC-R4RC/5,0-93E/R4RC	1408943	388	QPD C 3PE1,5 1X4-9 BK	1414694	455	QPD QSK BK 5X6,0 FS	1411400	474	QPD W 4PE2,5 9-16 M20 FC BK	1411399	475
NBC-R4RC/5,0-94B/R4RC	1408959	390				QPD QSK GY 5X2,5 FS	1404526	468	QPD W 4PE2,5 9-16 M25 0,5 BK	1582561	464
			QPD C 3PE1,5 2X4-9 BK	1414696	455	QPD QSK GY 5X6,0 FS	1411401	474	QPD W 4PE2,5 9-16 M25 0,5 EX	1411390	475
			QPD C 3PE1,5 2X8-13 BK	1414698	455	QPD T 2PE1,5 2X4-9 BK	1414711	453	QPD W 4PE2,5 9-16 M25 1,0 BK	1582562	464
			QPD C 3PE2,5 1X6-10 BK	1582220	463	QPD T 2PE1,5 2X8-13 BK	1414713	453	QPD W 4PE2,5 9-16 M25 1,0 EX	1411391	475
			QPD C 3PE2,5 1X9-14 BK	1582223	463	QPD T 2PE1,5 3X4-9 BK	1414712	453	QPD W 4PE2,5 9-16 M25 FC BK	1582563	465
			QPD C 3PE2,5 2X6-10 BK	1582211	463	QPD T 2PE1,5 3X8-13 BK	1414714	453	QPD W 4PE2,5 9-16 M25 FC BK	1411392	475
			QPD C 3PE2,5 2X9-14 BK	1582214	463	QPD T 3PE1,5 2X4-9 BK	1414707	453	QPD W 4PE2,5 M20 0,5 BK	1403737	464
			QPD C 4PE1,5 1X5-10 BK	1414739	455	QPD T 3PE1,5 2X8-13 BK	1414709	453	QPD W 4PE2,5 M20 1,0 BK	1403739	464
			QPD C 4PE1,5 1X9-14 BK	1414741	455	QPD T 3PE1,5 3X4-9 BK	1414708	453	QPD W 4PE2,5 M20 FC BK	1403741	465
			QPD C 4PE1,5 2X5-10 BK	1414740	455	QPD T 3PE1,5 3X8-13 BK	1414710	453	QPD W 4PE2,5 M25 0,5 BK	1582565	464
			QPD C 4PE1,5 2X9-14 BK	1414742	455	QPD T 4PE 2X6-11 BK	1405403	462	QPD W 4PE2,5 M25 1,0 BK	1582566	464
			QPD C 4PE2,5 1X6-11 BK	1403834	463	QPD T 4PE 2X9-16 BK	1405404	462	QPD W 4PE2,5 M25 FC BK	1582567	465
			QPD C 4PE2,5 1X9-16 BK	1403831	463	QPD T 4PE 3X6-11 BK	1405401	462	QPD W 4PE6,0 12-20 M25 0,5 BK	1410394	472
			QPD C 4PE2,5 2X6-11 BK	1403838	463	QPD T 4PE 3X9-16 BK	1405402	462	QPD W 4PE6,0 12-20 M25 1,0 BK	1410395	472
			QPD C 4PE2,5 2X9-16 BK	1403836	463	QPD T 4PE1,5 2X5-10 BK	1414751	453	QPD W 4PE6,0 9-14 M25 0,5 BK	1410392	472
			QPD C 4PE6,0 1X12-20 BK	1410416	471	QPD T 4PE1,5 2X9-14 BK	1414752	453	QPD W 4PE6,0 9-14 M25 1,0 BK	1410393	472
			QPD C 4PE6,0 1X9-14 BK	1410415	471	QPD T 4PE1,5 3X5-10 BK	1414753	453	QPD W 4PE6,0 M25 0,5 BK	1410396	472
			QPD C 4PE6,0 2X12-20 BK	1410412	466	QPD T 4PE1,5 3X9-14 BK	1414754	453	QPD W 4PE6,0 M25 1,0 BK	1410397	472
			QPD C 4PE6,0 2X9-14 BK	1410410	466	QPD T 4PE6,0 2X12-20 BK	1411417	470	QPDW3PE1,5 6-10 M25 0,1 BKKTH	1582475	476
			QPD CLIP 2,5 BK	1582235	468	QPD T 4PE6,0 2X9-14 BK	1411416	470	QPDW3PE1,5 9-14 M25 0,1 BKKTH	1582476	476
			QPD H 2PE1,5 4X4-9 BK	1414719	452	QPD T 4PE6,0 3X12-20 BK	1411415	470	QSS 15	1641992	460
			QPD H 2PE1,5 4X8-13 BK	1414720	452	QPD T 4PE6,0 3X9-14 BK	1411414	470	QSS 19	1670895	460
			QPD H 2PE1,5 BK	1414721	452	QPD W 2PE1,5 4-9 M20 0,5 BK	1414684	457	QSS 22	1670206	296
			QPD H 3PE1,5 4X4-9 BK	1414715	452	QPD W 2PE1,5 4-9 M20 1,0 BK	1414685	457	QSS 24	1670219	468
			QPD H 3PE1,5 4X8-13 BK	1414716	452	QPD W 2PE1,5 5-9 M20 FC BK	1414686	458	QSS 27	1670646	468
			QPD H 3PE1,5 BK	1414717	452	QPD W 2PE1,5 8-13 M20 0,5 BK	1414687	457			
			QPD H 3PE2,5 6-10 BK	1582145	461	QPD W 2PE1,5 8-13 M20 1,0 BK	1414688	457			
			QPD H 3PE2,5 9-14 BK	1582148	461	QPD W 2PE1,5 8-13 M20 FC BK	1414689	458			
			QPD H 3PE2,5 BK	1582154	461	QPD W 2PE1,5 M20 0,5 BK	1414690	457			
			QPD H 4PE1,5 4X5-10 BK	1414755	452	QPD W 2PE1,5 M20 1,0 BK	1414691	457			
			QPD H 4PE1,5 4X9-14 BK	1414756	452	QPD W 2PE1,5 M20 FC BK	1414692	458			
			QPD H 4PE1,5 BK	1414757	452	QPD W 3PE1,5 4-9 M20 0,5 BK	1414675	457			
			QPD H 4PE2,5 4X6-11 BK	1406368	461	QPD W 3PE1,5 4-9 M20 1,0 BK	1414676				

Type	Order No.	Page	Type	Order No.	Page	Type	Order No.	Page	Type	Order No.	Page
RC-22S2000	1603327	86	SAC- 3,0/0,1-116/2XB-1L-Z	1458172	229	SAC-12P-MS/ 3,0-PVC SCO	1554788	199	SAC-2P- 3,0-PUR/DTFS-1L-S	1410733	232
RC-5AP2000	1603505	86	SAC- 3,0/0,1-116/2XBI-1L-Z	1458350	229	SAC-12P-MS/ 5,0-35T SH SCO	1430064	200	SAC-2P- 3,0-PUR/SUSFS	1410749	233
RC-5AS2000	1603509	86	SAC- 3,0/0,15-116/2XA-1L-Z	1458033	229	SAC-12P-MS/ 5,0-PUR SCO	1430556	198	SAC-2P- 5,0-910/FSB SCO	1518074	231
RC-5CP2000	1603513	86	SAC- 3,0/0,15-116/2XB-1L-Z	1458211	229	SAC-12P-MS/ 5,0-PVC SCO	1554791	199	SAC-2P- 5,0-910/M12FSB	1507308	413
RC-5CS2000	1603517	86	SAC- 3,0/0,15-116/2XBI-1L-Z	1458392	229	SAC-12P-MS/0,5-35T/M23FS SHSCO	1437326	200	SAC-2P- 5,0-PUR/DTFS	1410726	230
RC-Z2058	1604223	166	SAC- 3,0/0,2-116/2XA-1L-Z	1458075	229	SAC-12P-MS/1,0-35T/M23FS SHSCO	1437339	200	SAC-2P- 5,0-PUR/DTFS-1L	1410730	231
RC-Z2059	1604225	166	SAC- 3,0/0,2-116/2XB-1L-Z	1458253	229	SAC-12P-MS/10,0-35T SH SCO	1430077	200	SAC-2P- 5,0-PUR/DTFS-1L-S	1410734	232
RC-Z2062	1604228	167	SAC- 3,0/0,2-116/2XBI-1L-Z	1458431	229	SAC-12P-MS/10,0-PUR SCO	1430569	198	SAC-2P- 5,0-PUR/SUSFS	1410750	233
RC-Z2068	1604236	167	SAC- 5,0/0,1-116/2XA-1L-Z	1458004	229	SAC-12P-MS/10,0-PVC SCO	1554801	199	SAC-2P-10,0-910/FSB SCO	1518083	413
RC-Z2104	1604260	167	SAC- 5,0/0,1-116/2XB-1L-Z	1458185	229	SAC-12P-MS/2,0-35T/M23FS SHSCO	1437342	200	SAC-2P-10,0-910/M12FSB	1507311	413
RC-Z2130	1604267	156	SAC- 5,0/0,1-116/2XBI-1L-Z	1458363	229	SAC-12P-MS/5,0-35T/M23FS SHSCO	1437355	200	SAC-2P-10,0-PUR/DTFS	1410727	230
RC-Z2274	1604409	156	SAC- 5,0/0,15-116/2XA-1L-Z	1458046	229	SAC-14P- 5,0-PUR/M16FR	1693746	291	SAC-2P-10,0-PUR/DTFS-1L	1410731	231
RC-Z2468	1611796	166	SAC- 5,0/0,15-116/2XB-1L-Z	1458224	229	SAC-14P-10,0-PUR/M16FR	1693759	291	SAC-2P-10,0-PUR/DTFS-1L-S	1410735	232
RC-Z2469	1611797	166	SAC- 5,0/0,15-116/2XBI-1L-Z	1458402	229	SAC-17P- 1,5-35T/FR SH SCO	1430329	201	SAC-2P-10,0-PUR/SUSFS	1410751	233
RC-Z2490	1611803	156	SAC- 5,0/0,2-116/2XA-1L-Z	1458088	229	SAC-17P- 1,5-35T/FS SH SCO	1430284	201	SAC-2P-15,0-910/FSB SCO	1518096	413
RC-Z2494	1614123	156	SAC- 5,0/0,2-116/2XB-1L-Z	1458266	229	SAC-17P- 1,5-PUR/FR SCO	1430815	198	SAC-2P-15,0-910/M12FSB	1507324	413
RC-Z2514	1614590	156	SAC- 5,0/0,2-116/2XBI-1L-Z	1458444	229	SAC-17P- 1,5-PUR/FS SCO	1430776	198	SAC-2P-910/...	1511491	413
RC/TGGM/KVD/LBL 16+3	1685505	294	SAC-10,0/0,1-116/2XB-1L-Z	1458017	229	SAC-17P- 1,5-PVC/FR SCO	1555389	199	SAC-2P-960/...	1432389	422
RC/TWGM/KVD/LBL 16+3	1685518	294	SAC-10,0/0,1-116/2XB-1L-Z	1458198	229	SAC-17P- 1,5-PVC/FS SCO	1555347	199	SAC-2P-961/...	1434620	421
RCK-TWGM/BL16+3/ 5,0PUR SH	1519529	294	SAC-10,0/0,1-116/2XBI-1L-Z	1458376	229	SAC-17P- 3,0-35T/FR SH SCO	1430336	201	SAC-2P-DTMS/ 0,3-PUR/DTFS	1414991	230
RCK-TWGM/BL16+3/10,0PUR SH	1511828	294	SAC-10,0/0,15-116/2XA-1L-Z	1458059	229	SAC-17P- 3,0-35T/FS SH SCO	1430297	201	SAC-2P-DTMS/ 0,6-PUR/DTFS	1414992	230
REDUC-M-KV-M20/M16	1647611	696	SAC-10,0/0,15-116/2XB-1L-Z	1458237	229	SAC-17P- 3,0-PUR/FR SCO	1430828	198	SAC-2P-DTMS/ 1,5-PUR/DTFS	1414993	230
REDUC-M-KV-M25/M20	1647624	696	SAC-10,0/0,15-116/2XBI-1L-Z	1458415	229	SAC-17P- 3,0-PUR/FS SCO	1430789	198	SAC-2P-DTMS/ 3,0-PUR/DTFS	1414994	230
REDUC-M-KV-M32/M25	1647637	696	SAC-10,0/0,2-116/2XA-1L-Z	1458091	229	SAC-17P- 3,0-PVC/FR SCO	1555392	199	SAC-2P-FRB SCO/910/...	1433249	413
REDUC-M-KV-M40/M32	1647640	696	SAC-10,0/0,2-116/2XB-1L-Z	1458279	229	SAC-17P- 3,0-PVC/FS SCO	1555350	199	SAC-2P-FSB SCO/910/...	1538076	413
RF-12P1N8AAC00	1607802	97	SAC-10,0/0,2-116/2XBI-1L-Z	1458457	229	SAC-17P- 5,0-35T/FR SH SCO	1430349	201	SAC-2P-M 8MS-A-1L-Z/...	1405650	214
RF-12P1N8AAD00	1607233	97	SAC-10P- 5,0-PUR/M16FR	1693704	291	SAC-17P- 5,0-35T/FS SH SCO	1430307	201	SAC-2P-M 8MS-B-1L-Z/...	1405651	214
RF-12P1N8AWA00	1607236	96	SAC-10P-10,0-PUR/M16FR	1693717	291	SAC-17P- 5,0-PUR/FR SCO	1430831	198	SAC-2P-M 8MS-BI-1L-Z/...	1405652	214
RF-12P1N8AWB00	1607804	96	SAC-12P- 0,5-35T/FS SH SCO	1437083	200	SAC-17P- 5,0-PUR/FS SCO	1430792	198	SAC-2P-M 8MS-C-1L-Z/...	1405653	214
RF-12P2N8AAC00	1607814	97	SAC-12P- 1,0-35T/FS SH SCO	1434730	200	SAC-17P- 5,0-PVC/FR SCO	1555402	199	SAC-2P-M 8MS-CI-1L-Z/...	1405654	214
RF-12P2N8AAD00	1607257	97	SAC-12P- 1,5-35T/FR SH SCO	1430161	200	SAC-17P- 5,0-PVC/FS SCO	1555363	199	SAC-2P-M12FSB/910/...	1538063	413
RF-12P2N8AWA00	1607260	96	SAC-12P- 1,5-35T/FS SH SCO	1430129	200	SAC-17P-10,0-35T/FR SH SCO	1430352	201	SAC-2P-M12MSB-M12FSB/910/...	1538089	413
RF-12P2N8AWB00	1607817	96	SAC-12P- 1,5-PUR/FR SCO	1430653	198	SAC-17P-10,0-35T/FS SH SCO	1430310	201	SAC-2P-M12MSB/ 0,3-910/M12FSB	1507340	413
RF-12S1N8AAC00	1607827	97	SAC-12P- 1,5-PUR/FS SCO	1430611	198	SAC-17P-10,0-PUR/FR SCO	1430844	198	SAC-2P-M12MSB/ 0,5-910/M12FSB	1507353	413
RF-12S1N8AAD00	1607280	97	SAC-12P- 1,5-PVC/FR SCO	1554898	199	SAC-17P-10,0-PUR/FS SCO	1430802	198	SAC-2P-M12MSB/ 1,0-910/M12FSB	1507366	413
RF-12S1N8AWA00	1607283	96	SAC-12P- 1,5-PVC/FS SCO	1554856	199	SAC-17P-10,0-PVC/FR SCO	1555415	199	SAC-2P-M12MSB/ 2,0-910	1507243	413
RF-12S1N8AWB00	1607830	96	SAC-12P- 3,0-35T/FR SH SCO	1430174	200	SAC-17P-10,0-PVC/FS SCO	1555376	199	SAC-2P-M12MSB/ 2,0-910/M12FSB	1507379	413
RF-12S2N8AAC00	1607842	97	SAC-12P- 3,0-35T/FS SH SCO	1430132	200	SAC-17P-100,0-PVC/0,14	1441545	282	SAC-2P-M12MSB/ 5,0-910	1507256	413
RF-12S2N8AAD00	1607304	97	SAC-12P- 3,0-PUR/FR SCO	1430666	198	SAC-17P-M23MS/0,5-35T/FS SHSCO	1437368	201	SAC-2P-M12MSB/ 5,0-910/M12FSB	1507382	413
RF-12S2N8AWA00	1607307	96	SAC-12P- 3,0-PUR/FS SCO	1430624	198	SAC-17P-M23MS/1,0-35T/FS SHSCO	1437371	201	SAC-2P-M12MSB/ 5,0-910/M12FSB	1507269	413
RF-12S2N8AWB00	1607844	96	SAC-12P- 3,0-PVC/FR SCO	1554908	199	SAC-17P-M23MS/2,0-35T/FS SHSCO	1437384	201	SAC-2P-M12MSB/10,0-910/M12FSB	1507395	413
RF-17P1N8AAC00	1607852	97	SAC-12P- 3,0-PVC/FS SCO	1554869	199	SAC-17P-M23MS/5,0-35T/FS SHSCO	1437397	201	SAC-2P-M12MSB/15,0-910	1507272	413
RF-17P1N8AAD00	1607328	97	SAC-12P- 5,0-35T/FR SH SCO	1430187	200	SAC-17P-MR/ 1,5-35T SH SCO	1430242	201	SAC-2P-M12MSB/15,0-910/M12FSB	1507405	413
RF-17P1N8AWA00	1607860	96	SAC-12P- 5,0-35T/FS SH SCO	1430145	200	SAC-17P-MR/ 1,5-PUR SCO	1430734	198	SAC-2P-M12MSB/910/...	1538047	413
RF-17P1N8AWB00	1607863	96	SAC-12P- 5,0-PUR/FR SCO	1430679	198	SAC-17P-MR/ 1,5-PVC SCO	1555305	199	SAC-2P-MRB SCO/910/...	1433236	413
RF-17S1N8AAC00	1607887	97	SAC-12P- 5,0-PUR/FS SCO	1430637	198	SAC-17P-MR/ 3,0-35T SH SCO	1430255	201	SAC-2P-MRB-FRB SCO/910/...	1433278	413
RF-17S1N8AAD00	1607345	97	SAC-12P- 5,0-PUR/M16FR	1693720	291	SAC-17P-MR/ 3,0-PUR SCO	1430747	198	SAC-2P-MRB-FSB SCO/910/...	1433265	413
RF-17S1N8AWA00	1607892	96	SAC-12P- 5,0-PVC/FR SCO	1554924	199	SAC-17P-MR/ 3,0-PVC SCO	1555318	199	SAC-2P-MSB SCO/910/...	1538050	413
RF-17S1N8AWB00	1607893	96	SAC-12P- 5,0-PVC/FS SCO	1554872	199	SAC-17P-MR/ 5,0-35T SH SCO	1430268	201	SAC-2P-MSB-FRB SCO/910/...	1433252	413
RF-Z0001	1607904	162	SAC-12P-10,0-35T/FR SH SCO	1430190	200	SAC-17P-MR/ 5,0-PUR SCO	1430750	198	SAC-2P-MSB-FSB SCO/910/...	1538092	413
RF-Z0003	1607905	162	SAC-12P-10,0-35T/FS SH SCO	1430158	200	SAC-17P-MR/ 5,0-PVC SCO	1555321	199	SAC-2P-MSB/ 0,3-910/FSB SCO	1518106	413
RF-Z0007	1614347	161	SAC-12P-10,0-PUR/FR SCO	1430682	198	SAC-17P-MR/10,0-35T SH SCO	1430271	201	SAC-2P-MSB/ 0,5-910/FSB SCO	1518119	413
RF-Z0014	1620588	164	SAC-12P-10,0-PUR/FS SCO	1430640	198	SAC-17P-MR/10,0-PUR SCO	1430763	198	SAC-2P-MSB/ 1,0-910/FSB SCO	1518122	413
RF-Z0015	1620592	164	SAC-12P-10,0-PUR/M16FR	1693733	291	SAC-17P-MR/10,0-PVC SCO	1555334	199	SAC-2P-MSB/ 2,0-910 SCO	1518025	413
RF-Z0016	1620593	164	SAC-12P-10,0-PVC/FR SCO	1554937	199	SAC-17P-MS/ 1,5-35T SH SCO	1430200	201	SAC-2P-MSB/ 2,0-910/FSB SCO	1518135	413
RF-Z0017	1620624	164	SAC-12P-10,0-PVC/FS SCO	1554885	199	SAC-17P-MS/ 1,5-PUR SCO	1430695	198	SAC-2P-MSB/ 5,0-910 SCO	1518038	413
RF-Z0018	1620625	164	SAC-12P-100,0-35T/SH-0,14	1405789	283	SAC-17P-MS/ 1,5-PVC SCO	1555266	199	SAC-2P-MSB/ 5,0-910/FSB SCO	1518148	413
RF-Z0019	1620626	164	SAC-12P-100,0-PVC/0,14	1441532	282	SAC-17P-MS/ 3,0-35T SH SCO	1430213	201	SAC-2P-MSB/ 10,0-910 SCO	1518041	413
			SAC-12P-M23MS/0,5-35T/FS SHSCO	1437287	200	SAC-17P-MS/ 3,0-PUR SCO	1430705	198	SAC-2P-MSB/10,0-910/FSB SCO	1518151	413
			SAC-12P-M23MS/1,0-35T/FS SHSCO	1437290	200	SAC-17P-MS/ 3,0-PVC SCO	1555279	199	SAC-2P-MSB/15,0-910 SCO	1518054	413
			SAC-12P-M23MS/2,0-35T/FS SHSCO	1437300	200	SAC-17P-MS/ 5,0-35T SH SCO	1430226	201	SAC-2P-MSB/15,0-910/FSB SCO	1518164	413
			SAC-12P-M23MS/5,0-35T/FS SHSCO	1437313	200	SAC-17P-MS/ 5,0-PUR SCO	1430718	198	SAC-2P-SUSMS/ 0,3-PUR/SUSFS	1410757	233
			SAC-12P-MR/ 1,5-35T SH SCO	1430080	200	SAC-17P-MS/ 5,0-PVC SCO	1555282	199	SAC-2P-SUSMS/ 0,6-PUR/SUSFS	1410759	233
			SAC-12P-MR/ 1,5-PUR SCO	1430572	198	SAC-17P-MS/0,5-35T/M23FS SHSCO	1437407	201	SAC-2P-SUSMS/ 1,5-PUR	1410752	233
SAC BIT HOOD-W 24	1212486	290	SAC-12P-MR/ 1,5-PVC SCO	1554814	199	SAC-17P-MS/1,0-35T/M23FS SHSCO	1437410	201	SAC-2P-SUSMS/ 1,5-PUR/SUSFS	1410760	233
SAC BIT M12-D15	1208432	286	SAC-12P-MR/ 3,0-35T SH SCO	1430093	200	SAC-17P-MS/10,0-35T SH SCO	1430239	201	SAC-2P-SUSMS/ 3,0-PUR	1410753	233
SAC BIT M12-W14	1212513	55	SAC-12P-MR/ 3,0-PUR SCO	1430585	198	SAC-17P-MS/10,0-35T/FS SH SCO	1402422	201	SAC-2P-SUSMS/ 3,0-PUR/SUSFS	1410761	233
SAC BIT M8-D10	1208461	286	SAC-12P-MR/ 3,0-PVC SCO	1554827	199	SAC-17P-MS/10,0-PUR SCO	1430721	198	SAC-2P-SUSMS/ 5,0-PUR	1410755	233
SAC BIT MIN-D25	1212512	55	SAC-12P-MR/ 5,0-35T SH								

Index

Alphabetical

Type	Order No.	Page	Type	Order No.	Page	Type	Order No.	Page	Type	Order No.	Page
SAC-3P-1,5-PUR/B-1L-R-ES	1401294	220	SAC-3P-3,0-PUR/M12FR B	1668205	174	SAC-3P-5,0-PVC/C-1L-V	1415937	217	SAC-3P-100,0-534/0,75	1457432	284
SAC-3P-1,5-PUR/B-1L-V	1443145	216	SAC-3P-3,0-PUR/M12FR SH	1682825	179	SAC-3P-5,0-PVC/C-1L-Z	1439528	215	SAC-3P-100,0-PUR/0,25	1501689	282
SAC-3P-1,5-PUR/B-1L-Z	1435386	214	SAC-3P-3,0-PUR/M12FR-2L	1694402	174	SAC-3P-5,0-PVC/C1-1L-V	1415943	217	SAC-3P-100,0-PUR/0,34	1501650	282
SAC-3P-1,5-PUR/B1-1L-R-ES	1401340	220	SAC-3P-3,0-PUR/M12FR-2L B	1668263	174	SAC-3P-5,0-PVC/C1-1L-Z	1415940	215	SAC-3P-100,0-PUR/0,5	1457393	284
SAC-3P-1,5-PUR/B1-1L-V	1443187	216	SAC-3P-3,0-PUR/M12FS	1694499	174	SAC-3P-5,0-PVC/FRS PE SCO	1411650	271	SAC-3P-100,0-PUR/SH-0,25	1526525	283
SAC-3P-1,5-PUR/B1-1L-Z	1435234	214	SAC-3P-3,0-PUR/M12FS B	1668085	174	SAC-3P-5,0-PVC/FSS PE SCO	1411646	271	SAC-3P-100,0-PUR/SH-0,34	1501702	283
SAC-3P-1,5-PUR/C-1L-R-ES	1401434	220	SAC-3P-3,0-PUR/M12FS SH	1682799	179	SAC-3P-5,0-PVC/M 8FR	1403253	176	SAC-3P-100,0-PVC/0,25	1501654	282
SAC-3P-1,5-PUR/C-1L-V	1443226	216	SAC-3P-3,0-PUR/M12FS-2L	1694198	174	SAC-3P-5,0-PVC/M 8FR-2L	1508174	176	SAC-3P-100,0-PVC/0,34	1501825	282
SAC-3P-1,5-PUR/C1-1L-Z	1435355	214	SAC-3P-3,0-PUR/M5FR	1530511	170	SAC-3P-5,0-PVC/M 8FS	1510748	176	SAC-3P-100,0-PVC/SH-0,34	1550656	283
SAC-3P-1,5-PUR/C1-1L-R-ES	1401466	220	SAC-3P-3,0-PUR/M5FS	1530430	170	SAC-3P-5,0-PVC/M12FR	1579051	176	SAC-3P-15,0-P61/M12FR VA	1419090	414
SAC-3P-1,5-PUR/C1-1L-V	1443268	216	SAC-3P-3,0-PVC/A	1415921	225	SAC-3P-5,0-PVC/M12FR-2L	1505326	176	SAC-3P-15,0-961/M12FS VA	1419085	414
SAC-3P-1,5-PUR/C1-1L-Z	1435687	214	SAC-3P-3,0-PVC/A-1L-V	1415909	217	SAC-3P-5,0-PVC/M12FS	1400505	176	SAC-3P-20,0-961/M12FR VA	1419091	414
SAC-3P-1,5-PUR/DTFS	1414995	230	SAC-3P-3,0-PVC/A-1L-V 230V	1415913	219	SAC-3P-5,0-PVC/M12FS-2L	1508459	176	SAC-3P-20,0-961/M12FS VA	1419086	414
SAC-3P-1,5-PUR/M 8FR	1669738	174	SAC-3P-3,0-PVC/A-1L-R	1415905	215	SAC-3P-1,5-PUR/A-1L-R	1400589	222	SAC-3P-3,0-PUR/A-1L-R	1400588	222
SAC-3P-1,5-PUR/M 8FR SH	1521766	179	SAC-3P-3,0-PVC/B-1L-V	1415926	217	SAC-3P-1,5-PVC/A-1L-R	1415916	223	SAC-3P-3,0-PVC/A-1L-R	1415917	223
SAC-3P-1,5-PUR/M 8FR-2L	1671069	174	SAC-3P-3,0-PVC/B-1L-Z	1415923	215	SAC-3P-10,0-800/M12FR	1454299	178	SAC-3P-5,0-PUR/A-1L-V 230V	1400648	218
SAC-3P-1,5-PUR/M 8FS	1669712	174	SAC-3P-3,0-PVC/BI-1L-V	1415932	217	SAC-3P-10,0-800/M12FR-2L	1454341	178	SAC-3P-5,0-PUR/C	1400814	224
SAC-3P-1,5-PUR/M 8FS SH	1521711	179	SAC-3P-3,0-PVC/BI-1L-Z	1400609	215	SAC-3P-10,0-800/M12FS	1456705	178	SAC-3P-5,0-PVC/A-1L-V 230V	1400882	216
SAC-3P-1,5-PUR/M12FR	1694509	174	SAC-3P-3,0-PVC/C-1L-V	1415936	217	SAC-3P-10,0-961/M12FR VA	1419089	414	SAC-3P-A-1L-V/.....	1400876	216
SAC-3P-1,5-PUR/M12FR B	1668195	174	SAC-3P-3,0-PVC/C-1L-Z	1439515	215	SAC-3P-10,0-961/M12FS VA	1419084	414	SAC-3P-A-1L-Z/.....	1435027	214
SAC-3P-1,5-PUR/M12FR SH	1668212	179	SAC-3P-3,0-PVC/CI-1L-V	1415942	217	SAC-3P-10,0-PUR/A	1400732	224	SAC-3P-A/.....	1400897	224
SAC-3P-1,5-PUR/M12FR-2L	1694392	174	SAC-3P-3,0-PVC/CI-1L-Z	1415939	215	SAC-3P-10,0-PUR/A-1L-R	1400799	222	SAC-3P-B-1L-V/.....	1400882	216
SAC-3P-1,5-PUR/M12FR-2L B	1668250	174	SAC-3P-3,0-PVC/M 8FR	1446320	176	SAC-3P-10,0-PUR/A-1L-R-ES	1413118	220	SAC-3P-B-1L-Z/.....	1435425	214
SAC-3P-1,5-PUR/M12FS	1694486	174	SAC-3P-3,0-PVC/M 8FR-2L	1415875	176	SAC-3P-10,0-PUR/A-1L-R-ES 4A	1401168	221	SAC-3P-B/.....	1400909	224
SAC-3P-1,5-PUR/M12FS B	1668072	174	SAC-3P-3,0-PVC/M 8FS	1415871	176	SAC-3P-10,0-PUR/A-1L-V	1443132	216	SAC-3P-B1-1L-V/.....	1400879	216
SAC-3P-1,5-PUR/M12FS SH	1682786	179	SAC-3P-3,0-PVC/M12FR	1414553	176	SAC-3P-10,0-PUR/A-1L-V 230V	1402986	218	SAC-3P-B1-1L-Z/.....	1435276	214
SAC-3P-1,5-PUR/M12FS-2L	1694185	174	SAC-3P-3,0-PVC/M12FR-2L	1414573	176	SAC-3P-10,0-PUR/A-1L-Z	1435014	214	SAC-3P-BI/.....	1400902	224
SAC-3P-1,5-PUR/M5FR	1530508	170	SAC-3P-3,0-PVC/M12FS	1414452	176	SAC-3P-10,0-PUR/B-1L-R-ES	1401339	220	SAC-3P-C-1L-V/.....	1400894	216
SAC-3P-1,5-PUR/M5FS	1530427	170	SAC-3P-3,0-PVC/M12FS-2L	1414561	176	SAC-3P-10,0-PUR/B-1L-V	1443174	216	SAC-3P-C-1L-Z/.....	1435726	214
SAC-3P-1,5-PVC/A	1415920	225	SAC-3P-5,0-800/M12FR	1454273	178	SAC-3P-10,0-PUR/B-1L-Z	1435412	214	SAC-3P-C/.....	1400921	224
SAC-3P-1,5-PVC/A-1L-V	1415908	217	SAC-3P-5,0-800/M12FR-2L	1454325	178	SAC-3P-10,0-PUR/BI	1438862	224	SAC-3P-C1-1L-V/.....	1400891	216
SAC-3P-1,5-PVC/A-1L-V 230V	1415912	219	SAC-3P-5,0-800/M12FS	1456695	178	SAC-3P-10,0-PUR/BI-1L-R-ES	1401359	220	SAC-3P-C1-1L-Z/.....	1435577	214
SAC-3P-1,5-PVC/A-1L-Z	1438684	215	SAC-3P-5,0-961/M12FR VA	1419088	414	SAC-3P-10,0-PUR/BI-1L-V	1443213	216	SAC-3P-CI/.....	1400918	224
SAC-3P-1,5-PVC/B-1L-V	1415925	217	SAC-3P-5,0-961/M12FS VA	1419083	414	SAC-3P-10,0-PUR/BI-1L-Z	1435263	214	SAC-3P-DTMS/0,3-PUR/DTFS	1415003	230
SAC-3P-1,5-PVC/B-1L-Z	1415922	215	SAC-3P-5,0-PUR/A	1402984	224	SAC-3P-10,0-PUR/C	1400641	224	SAC-3P-DTMS/0,6-PUR/DTFS	1415004	230
SAC-3P-1,5-PVC/BI-1L-V	1415931	217	SAC-3P-5,0-PUR/A-1L-R	1400798	222	SAC-3P-10,0-PUR/C-1L-R-ES	1401465	220	SAC-3P-DTMS/1,5-PUR/DTFS	1415005	230
SAC-3P-1,5-PVC/BI-1L-Z	1415929	215	SAC-3P-5,0-PUR/A-1L-R-ES	1413116	220	SAC-3P-10,0-PUR/C-1L-V	1443255	216	SAC-3P-DTMS/3,0-PUR	1415000	230
SAC-3P-1,5-PVC/C-1L-V	1415935	217	SAC-3P-5,0-PUR/A-1L-R-ES 4A	1401136	221	SAC-3P-10,0-PUR/CI-1L-Z	1435564	214	SAC-3P-DTMS/3,0-PUR/DTFS	1415006	230
SAC-3P-1,5-PVC/C-1L-Z	1439162	215	SAC-3P-5,0-PUR/A-1L-V	1443129	216	SAC-3P-10,0-PUR/CI-1L-R-ES	1401617	220	SAC-3P-DTMS/5,0-PUR/DTFS	1415007	230
SAC-3P-1,5-PVC/CI-1L-V	1415941	217	SAC-3P-5,0-PUR/A-1L-Z	1435001	214	SAC-3P-10,0-PUR/CI-1L-V	1443297	216	SAC-3P-DTMS/10,0-PUR	1415002	230
SAC-3P-1,5-PVC/CI-1L-Z	1439175	215	SAC-3P-5,0-PUR/B-1L-R-ES	1401338	220	SAC-3P-10,0-PUR/CI-1L-Z	1435713	214	SAC-3P-M 8FR SH/.....	1521805	179
SAC-3P-1,5-PVC/M 8FR	1415872	176	SAC-3P-5,0-PUR/B-1L-V	1443161	216	SAC-3P-10,0-PUR/DTFS	1414998	230	SAC-3P-M 8FR-2L/.....	1697616	174
SAC-3P-1,5-PVC/M 8FR-2L	1415874	176	SAC-3P-5,0-PUR/B-1L-Z	1435409	214	SAC-3P-10,0-PUR/M 8FR	1694169	174	SAC-3P-M 8FR/.....	1697603	174
SAC-3P-1,5-PVC/M 8FS	1415870	176	SAC-3P-5,0-PUR/BI	1439065	224	SAC-3P-10,0-PUR/M 8FR SH	1521795	179	SAC-3P-M 8FS SH/.....	1521753	179
SAC-3P-1,5-PVC/M12FR	1414552	176	SAC-3P-5,0-PUR/BI-1L-R-ES	1401358	220	SAC-3P-10,0-PUR/M 8FR-2L	1683594	174	SAC-3P-M 8FS/.....	1697580	174
SAC-3P-1,5-PVC/M12FR-2L	1414571	176	SAC-3P-5,0-PUR/BI-1L-V	1443200	216	SAC-3P-10,0-PUR/M 8FS	1694101	174	SAC-3P-M 8FR SH/.....	1521708	179
SAC-3P-1,5-PVC/M12FS	1414451	176	SAC-3P-5,0-PUR/BI-1L-Z	1435250	214	SAC-3P-10,0-PUR/M 8FS SH	1521740	179	SAC-3P-M 8FR SH/.....	1552081	179
SAC-3P-1,5-PVC/M12FS-2L	1414556	176	SAC-3P-5,0-PUR/C-1L-R-ES	1401448	220	SAC-3P-10,0-PUR/M12FR	1694538	174	SAC-3P-M 8FR SH/.....	1552081	179
SAC-3P-2,0-961/M12FR VA	1419087	414	SAC-3P-5,0-PUR/C-1L-V	1443242	216	SAC-3P-10,0-PUR/M12FR B	1681017	174	SAC-3P-M 8FR-2L/.....	1697687	174
SAC-3P-2,0-961/M12FS VA	1419082	414	SAC-3P-5,0-PUR/C-1L-Z	1435551	214	SAC-3P-10,0-PUR/M12FR SH	1500693	179	SAC-3P-M 8FR/.....	1697674	174
SAC-3P-2,0-PVC/FRS PE SCO	1411649	271	SAC-3P-5,0-PUR/CI-1L-R-ES	1401544	220	SAC-3P-10,0-PUR/M12FR-2L	1694428	174	SAC-3P-M 8FR-M 8FS SH/.....	1552078	179
SAC-3P-2,0-PVC/FSS PE SCO	1411645	271	SAC-3P-5,0-PUR/CI-1L-V	1443284	216	SAC-3P-10,0-PUR/M12FR-2L B	1681059	174	SAC-3P-M 8FR-M 8FS/.....	1697661	174
SAC-3P-3,0-800/M12FR	1456718	178	SAC-3P-5,0-PUR/CI-1L-Z	1435700	214	SAC-3P-10,0-PUR/M12FS	1693034	174	SAC-3P-M 8FR-M12FR-2L/.....	1697742	174
SAC-3P-3,0-800/M12FR-2L	1456721	178	SAC-3P-5,0-PUR/DTFS	1414997	230	SAC-3P-10,0-PUR/M12FS B	1694208	174	SAC-3P-M 8FR-M12FR/.....	1697739	174
SAC-3P-3,0-800/M12FS	1456682	178	SAC-3P-5,0-PUR/M 8FR	1669631	174	SAC-3P-10,0-PUR/M12FS SH	1500680	179	SAC-3P-M 8FR-M12FS/.....	1697726	174
SAC-3P-3,0-PUR/A	1439544	224	SAC-3P-5,0-PUR/M 8FR SH	1521782	179	SAC-3P-10,0-PUR/M12FS-2L	1694790	174	SAC-3P-M 8FR/0,3-PUR/M 8FR	1682061	174
SAC-3P-3,0-PUR/A-1L-R-ES	1413114	220	SAC-3P-5,0-PUR/M 8FR-2L	1671085	174	SAC-3P-10,0-PUR/M5FR	1530537	170	SAC-3P-M 8FR/0,3-PUR/M12FR-2L	1682469	174
SAC-3P-3,0-PUR/A-1L-R-ES 4A	1401131	221	SAC-3P-5,0-PUR/M 8FS	1669628	174	SAC-3P-10,0-PUR/M5FS	1530456	170	SAC-3P-M 8FR/0,3-PVC/M 8FR	1415891	176
SAC-3P-3,0-PUR/A-1L-V	1443116	216	SAC-3P-5,0-PUR/M 8FS SH	1521737	179	SAC-3P-10,0-PVC/A-1L-R	1402978	225	SAC-3P-M 8FR/0,6-PUR/M 8FR	1682074	174
SAC-3P-3,0-PUR/A-1L-V 230V	1400694	218	SAC-3P-5,0-PUR/M 8SIFR	1519891	172	SAC-3P-10,0-PVC/A-1L-Z	1415919	223	SAC-3P-M 8FR/0,6-PUR/M12FR-2L	1682472	174
SAC-3P-3,0-PUR/A-1L-Z	1434992	214	SAC-3P-5,0-PUR/M 8SIFS	1519875	172	SAC-3P-10,0-PVC/A-1L-V	1415911	217	SAC-3P-M 8FR/0,6-PVC/M 8FR	1415892	176
SAC-3P-3,0-PUR/B-1L-R-ES	1401295	220	SAC-3P-5,0-PUR/M12FR	1694525	174	SAC-3P-10,0-PVC/A-1L-V 230V	1415915	219	SAC-3P-M 8FR/1,5-PUR SH	1521669	179
SAC-3P-3,0-PUR/B-1L-V	1443158	216	SAC-3P-5,0-PUR/M12FR B	1668218	174	SAC-3P-10,0-PVC/A-1L-Z	1439492	215	SAC-3P-M 8FR/1,5-PUR/M 8FR	1682087	174
SAC-3P-3,0-PUR/B-1L-Z	1435399	214	SAC-3P-5,0-PUR/M12FR SH	1682838	179	SAC-3P-10,0-PVC/BI-1L-V	1415928	217	SAC-3P-M 8FR/1,5-PUR/M12FR-2L	1682485	174
SAC-3P-3,0-PUR/BI-1L-R-ES	1401350	220	SAC-3P-5,0-PUR/M12FR-2L	1694415	174	SAC-3P-10,0-PVC/BI-1L-Z	1400610	215	SAC-3P-M 8FR/1,5-PVC/M 8FR	1415893	176
SAC-3P-3,0-PUR/BI-1L-V	1443190	216	SAC-3P-5,0-PUR/M12FR-2L B	1668276	174	SAC-3P-10,0-PVC/BI-1L-Z	1415934	217	SAC-3P-M 8FR/3,0-PUR SH	1521672	179
SAC-3P-3,0-PUR/BI-1L-Z	1435247	214	SAC-3P-5,0-PUR/M12FS	1683510	174	SAC-3P-10,0-PVC/BI-1L-Z	1400607	215	SAC-3P-M 8FR/3,0-PUR/M 8FR	1682090	174
SAC-3P-3,0-PUR/C-1L-R-ES	1401435										

Type	Order No.	Page	Type	Order No.	Page	Type	Order No.	Page	Type	Order No.	Page
SAC-3P-M 8MR/0,6-PUR/M12FS	1682391	174	SAC-3P-M 8MS/3,0-PUR/M 8FR-2L	1682016	174	SAC-3P-M12MR/15,0-961/M12FS VA	1419116	414	SAC-3P-M12MS/3,0-PUR/M12FR SH	1500952	179
SAC-3P-M 8MR/0,6-PVC/M 8FR-2L	1415902	176	SAC-3P-M 8MS/3,0-PUR/M12FR	1682375	174	SAC-3P-M12MR/20,0-961 VA	1419101	414	SAC-3P-M12MS/3,0-PUR/M12FR-2L	1694583	174
SAC-3P-M 8MR/0,6-PVC/M 8FS	1415882	176	SAC-3P-M 8MS/3,0-PUR/M12FS	1682333	174	SAC-3P-M12MR/3,0-PUR/M12FR VA	1419133	414	SAC-3P-M12MS/3,0-PUR/M12FS SH	1500839	179
SAC-3P-M 8MR/1,5-PUR	1681693	174	SAC-3P-M 8MS/3,0-PVC	1415862	176	SAC-3P-M12MR/20,0-961/M12FS VA	1419117	414	SAC-3P-M12MS/3,0-PVC/M12FR	1415520	176
SAC-3P-M 8MR/1,5-PUR/M 8FR-2L	1682126	174	SAC-3P-M 8MS/3,0-PVC/M 8FR	1415890	176	SAC-3P-M12MR/3,0-PUR	1668140	174	SAC-3P-M12MS/3,0-PVC/M12FR-2L	1415524	176
SAC-3P-M 8MR/1,5-PUR/M 8FS	1682045	174	SAC-3P-M 8MS/3,0-PVC/M 8FR-2L	1415899	176	SAC-3P-M12MR/3,0-PUR/M 8FR	1668946	174	SAC-3P-M12MS/5,0-800	1456750	178
SAC-3P-M 8MR/1,5-PUR/M12FR	1682443	174	SAC-3P-M 8MS/5,0-PUR	1681680	174	SAC-3P-M12MR/3,0-PUR/M 8FS	1668904	174	SAC-3P-M12MS/5,0-961 VA	1419093	414
SAC-3P-M 8MR/1,5-PUR/M12FS	1682401	174	SAC-3P-M 8MS/5,0-PVC	1415863	176	SAC-3P-M12MR/3,0-PUR/M12FR B	1668661	174	SAC-3P-M12MS/5,0-961/M12FR VA	1419122	414
SAC-3P-M 8MR/1,5-PVC	1415865	176	SAC-3P-M 8SIFR-2L/.../...	1513402	172	SAC-3P-M12MR/3,0-PUR/M12FS B	1668580	174	SAC-3P-M12MS/5,0-961/M12FS VA	1419106	414
SAC-3P-M 8MR/1,5-PVC/M 8FR-2L	1415903	176	SAC-3P-M 8SIFR/.../...	1697629	172	SAC-3P-M12MR/3,0-PVC	1414448	176	SAC-3P-M12MS/5,0-PUR SH	1682766	179
SAC-3P-M 8MR/1,5-PVC/M 8FS	1415883	176	SAC-3P-M 8SIFS/.../...	1697593	172	SAC-3P-M12MR/3,0-PVC/M 8FR	1415541	176	SAC-3P-M12MS/.../...	1696662	174
SAC-3P-M 8MR/10,0-PUR	1694114	174	SAC-3P-M 8Y/2XM 8FS	1696183	238	SAC-3P-M12MR/3,0-PVC/M 8FS	1415537	176	SAC-3P-M12MS/3,0-PUR/M 8FR	1668836	174
SAC-3P-M 8MR/10,0-PUR SH	1521698	179	SAC-3P-M 8Y/2XM 8FS VP	1696222	239	SAC-3P-M12MR/5,0-PUR	1668153	174	SAC-3P-M12MS/3,0-PUR/M 8FR-2L	1694884	174
SAC-3P-M 8MR/10,0-PVC	1682456	176	SAC-3P-M12FR B/.../...	1696727	174	SAC-3P-M12MR/5,0-PVC	1414449	176	SAC-3P-M12MS/3,0-PUR/M 8FR	1668797	174
SAC-3P-M 8MR/3,0-PUR	1681703	174	SAC-3P-M12FR SH/.../...	1697454	179	SAC-3P-M12MS SH/.../...	1697425	179	SAC-3P-M12MS/3,0-PUR/M12FR-2L	1668438	174
SAC-3P-M 8MR/3,0-PUR/M 8FR-2L	1682139	174	SAC-3P-M12FR-2L/.../...	1696730	174	SAC-3P-M12MS-M 8FR-2L/.../...	1696879	174	SAC-3P-M12MS/3,0-PUR/M12FS	1681509	174
SAC-3P-M 8MR/3,0-PUR/M 8FS	1682058	174	SAC-3P-M12FR-2LB/.../...	1696743	174	SAC-3P-M12MS-M 8FR/.../...	1696866	174	SAC-3P-M12MS/3,0-PUR/M12FS B	1668315	176
SAC-3P-M 8MR/3,0-PUR/M12FR	1682456	174	SAC-3P-M12FR/.../...	1696714	174	SAC-3P-M12MS-M 8FS	1519752	240	SAC-3P-M12MS/3,0-PVC/M 8FR	1415530	174
SAC-3P-M 8MR/3,0-PUR/M12FS	1682414	174	SAC-3P-M12FS B/.../...	1696691	174	SAC-3P-M12MS-M 8FS/.../...	1696840	174	SAC-3P-M12MS/3,0-PVC/M 8FS	1415525	176
SAC-3P-M 8MR/3,0-PVC	1415866	176	SAC-3P-M12FS SH/.../...	1697441	179	SAC-3P-M12MS-M 8SIFR-2L/.../...	1515675	172	SAC-3P-M12MS/3,0-PVC/M12FS	1414576	176
SAC-3P-M 8MR/3,0-PVC/M 8FR-2L	1415904	176	SAC-3P-M12FS-2L/.../...	1696701	174	SAC-3P-M12MS-M 8SIFR/.../...	1696882	172	SAC-3P-M12MS/0,6-PUR/M 8FR	1668849	174
SAC-3P-M 8MR/3,0-PVC/M 8FS	1415884	176	SAC-3P-M12FS/.../...	1696688	174	SAC-3P-M12MS-M 8SIFS/.../...	1519781	240	SAC-3P-M12MS/0,6-PUR/M 8FR-2L	1694897	174
SAC-3P-M 8MR/5,0-PUR	1681716	174	SAC-3P-M12MR SH/.../...	1697438	179	SAC-3P-M12MS-M 8SIFS/.../...	1696853	172	SAC-3P-M12MS/0,6-PUR/M 8FS	1668807	174
SAC-3P-M 8MR/5,0-PVC	1415867	176	SAC-3P-M12MR-M 8FR-2L/.../...	1696918	174	SAC-3P-M12MS-M12FR B/.../...	1696785	174	SAC-3P-M12MS/0,6-PUR/M12FR-2L	1668841	174
SAC-3P-M 8MS SH/.../...	1521656	179	SAC-3P-M12MR-M 8FR/.../...	1696905	174	SAC-3P-M12MS-M12FR SH/.../...	1536052	179	SAC-3P-M12MS/0,6-PUR/M12FS	1681512	174
SAC-3P-M 8MS-M 8FR SH/.../...	1552065	179	SAC-3P-M12MR-M 8FS/.../...	1696895	174	SAC-3P-M12MS-M12FR-2L/.../...	1696798	174	SAC-3P-M12MS/0,6-PUR/M12FS B	1668328	174
SAC-3P-M 8MS-M 8FR-2L/.../...	1697658	174	SAC-3P-M12MR-M12FR B/.../...	1696824	174	SAC-3P-M12MS-M12FR-2LB/.../...	1696808	174	SAC-3P-M12MS/0,6-PVC/M 8FR	1415531	176
SAC-3P-M 8MS-M 8FR-2L/.../...	1697645	174	SAC-3P-M12MR-M12FR SH/.../...	1536078	179	SAC-3P-M12MS-M12FR SH/.../...	1696772	174	SAC-3P-M12MS/0,6-PVC/M 8FS	1415527	176
SAC-3P-M 8MS-M 8FS SH/.../...	1552052	179	SAC-3P-M12MR-M12FR-2LB/.../...	1696837	174	SAC-3P-M12MS-M12FS B/.../...	1696769	174	SAC-3P-M12MS/0,6-PVC/M12FS	1414577	176
SAC-3P-M 8MS-M 8FS/.../...	1697632	174	SAC-3P-M12MR-M12FS B/.../...	1696811	174	SAC-3P-M12MS-M12FS SH/.../...	1536049	179	SAC-3P-M12MS/1,5-PUR	1668014	174
SAC-3P-M 8MS-M12FR-2L/.../...	1697713	174	SAC-3P-M12MR-M12FS SH/.../...	1536065	179	SAC-3P-M12MS-M12FS-2L/.../...	1511802	174	SAC-3P-M12MS/1,5-PUR/M 8FR	1668852	174
SAC-3P-M 8MS-M12FR/.../...	1697700	174	SAC-3P-M12MR-M12FS-2L/.../...	1524763	174	SAC-3P-M12MS-M12FR B/.../...	1696756	174	SAC-3P-M12MS/1,5-PUR/M 8FR-2L	1694907	174
SAC-3P-M 8MS-M12FS	1519749	240	SAC-3P-M12MR/0,3-961/M12FR VA	1419126	414	SAC-3P-M12MS/0,3-800/M12FR	1456815	178	SAC-3P-M12MS/1,5-PUR/M 8FS	1668810	174
SAC-3P-M 8MS-M12FS-2L/.../...	1514197	174	SAC-3P-M12MR/0,3-961/M12FS VA	1419110	414	SAC-3P-M12MS/0,3-800/M12FR-2L	1456857	178	SAC-3P-M12MS/1,5-PUR/M12FR-2L	1668454	174
SAC-3P-M 8MS-M12FS/.../...	1697690	174	SAC-3P-M12MR/0,5-961/M12FR VA	1419127	414	SAC-3P-M12MS/0,3-800/M12FS	1456776	178	SAC-3P-M12MS/1,5-PUR/M12FS	1681525	174
SAC-3P-M 8MS/0,3-PUR/M 8FS	1681907	174	SAC-3P-M12MR/0,5-961/M12FS VA	1419111	414	SAC-3P-M12MS/0,3-961/M12FR VA	1419118	414	SAC-3P-M12MS/1,5-PUR/M12FS B	1668331	174
SAC-3P-M 8MS/0,3-PUR/M 8FS SH	1456310	179	SAC-3P-M12MR/1,0-961/M12FR VA	1419128	414	SAC-3P-M12MS/0,3-961/M12FS VA	1419102	414	SAC-3P-M12MS/1,5-PVC	1414434	176
SAC-3P-M 8MS/0,3-PUR/M12FR-2L	1693351	174	SAC-3P-M12MR/1,0-961/M12FS VA	1419112	414	SAC-3P-M12MS/0,3-PUR/M12FR	1681541	174	SAC-3P-M12MS/1,5-PVC/M 8FR	1415532	176
SAC-3P-M 8MS/0,3-PVC/M 8FS	1415877	176	SAC-3P-M12MR/1,5-800	1456899	178	SAC-3P-M12MS/0,3-PUR/M12FR B	1668399	174	SAC-3P-M12MS/1,5-PVC/M 8FS	1415528	176
SAC-3P-M 8MS/0,3-PUR/M 8FS	1681910	174	SAC-3P-M12MR/1,5-PUR SH	1682689	179	SAC-3P-M12MS/0,3-PUR/M12FR SH	1500923	179	SAC-3P-M12MS/1,5-PVC/M12FS	1414578	176
SAC-3P-M 8MS/0,6-PUR/M 8FS SH	1456323	179	SAC-3P-M12MR/2,0-961 VA	1419097	414	SAC-3P-M12MS/0,3-PUR/M12FR-2L	1694554	174	SAC-3P-M12MS/10,0-800	1456763	178
SAC-3P-M 8MS/0,6-PUR/M12FR-2L	1693364	174	SAC-3P-M12MR/2,0-961/M12FR VA	1419129	414	SAC-3P-M12MS/0,3-PUR/M12FS SH	1500809	179	SAC-3P-M12MS/10,0-961 VA	1419094	414
SAC-3P-M 8MS/0,6-PVC/M 8FS	1415878	176	SAC-3P-M12MR/2,0-961/M12FS VA	1419113	414	SAC-3P-M12MS/0,3-PVC/M12FR	1414580	176	SAC-3P-M12MS/10,0-961/M12FR VA	1419123	414
SAC-3P-M 8MS/1,5-PUR SH	1521614	179	SAC-3P-M12MR/3,0-800	1456909	178	SAC-3P-M12MS/0,3-PVC/M12FR-2L	1415521	176	SAC-3P-M12MS/10,0-961/M12FS VA	1419107	414
SAC-3P-M 8MS/1,5-PUR/M 8FS	1681923	174	SAC-3P-M12MR/3,0-PUR SH	1682692	179	SAC-3P-M12MS/0,5-961/M12FR VA	1419119	414	SAC-3P-M12MS/10,0-PUR	1682566	174
SAC-3P-M 8MS/1,5-PUR/M 8FS SH	1455285	179	SAC-3P-M12MR/5,0-800	1456912	178	SAC-3P-M12MS/0,5-961/M12FS VA	1419103	414	SAC-3P-M12MS/10,0-PUR SH	1500664	179
SAC-3P-M 8MS/1,5-PUR/M12FR-2L	1693380	174	SAC-3P-M12MR/5,0-961 VA	1419098	414	SAC-3P-M12MS/0,6-800/M12FR	1456828	178	SAC-3P-M12MS/10,0-PVC	1414437	176
SAC-3P-M 8MS/1,5-PVC/M 8FS	1415879	176	SAC-3P-M12MR/5,0-961/M12FR VA	1419130	414	SAC-3P-M12MS/0,6-800/M12FR-2L	1456860	178	SAC-3P-M12MS/15,0-961 VA	1419095	414
SAC-3P-M 8MS/3,0-PUR SH	1521527	179	SAC-3P-M12MR/5,0-961/M12FS VA	1419114	414	SAC-3P-M12MS/0,6-800/M12FS	1456789	178	SAC-3P-M12MS/15,0-961/M12FR VA	1419124	414
SAC-3P-M 8MS/3,0-PUR/M 8FS	1681936	174	SAC-3P-M12MR/5,0-PUR SH	1682702	179	SAC-3P-M12MS/0,6-PUR/M12FR	1681554	174	SAC-3P-M12MS/15,0-961/M12FS VA	1419108	414
SAC-3P-M 8MS/3,0-PUR/M12FR	1455298	179	SAC-3P-M12MR/.../...	1696675	174	SAC-3P-M12MS/0,6-PUR/M12FR B	1668409	174	SAC-3P-M12MS/15,0-961/M12FR VA	1419106	414
SAC-3P-M 8MS/3,0-PUR/M12FR-2L	1693403	174	SAC-3P-M12MR/0,3-PUR/M 8FR	1668917	174	SAC-3P-M12MS/0,6-PUR/M12FR SH	1500936	179	SAC-3P-M12MS/20,0-961/M12FR VA	1419125	414
SAC-3P-M 8MS/3,0-PVC/M 8FS	1415880	176	SAC-3P-M12MR/0,3-PUR/M 8FS	1668878	174	SAC-3P-M12MS/0,6-PUR/M12FR-2L	1694567	174	SAC-3P-M12MS/20,0-961/M12FS VA	1419109	414
SAC-3P-M 8MS/5,0-PUR SH	1521630	179	SAC-3P-M12MR/0,3-PUR/M12FR B	1668632	174	SAC-3P-M12MS/0,6-PUR/M12FS SH	1500813	179	SAC-3P-M12MS/3,0-PUR	1668027	174
SAC-3P-M 8MS/.../...	1697548	174	SAC-3P-M12MR/0,3-PUR/M12FS B	1668551	174	SAC-3P-M12MS/0,6-PVC/M12FR	1414581	176	SAC-3P-M12MS/3,0-PUR/M 8FR	1668865	174
SAC-3P-M 8MS/0,3-PUR/M 8FR	1681949	174	SAC-3P-M12MR/0,3-PVC/M 8FR	1415538	176	SAC-3P-M12MS/0,6-PVC/M12FR-2L	1415522	176	SAC-3P-M12MS/3,0-PUR/M 8FR-2L	1694910	174
SAC-3P-M 8MS/0,3-PUR/M 8FR-2L	1681981	174	SAC-3P-M12MR/0,3-PVC/M 8FS	1415534	176	SAC-3P-M12MS/1,0-961/M12FR VA	1419120	414	SAC-3P-M12MS/3,0-PUR/M 8FS	1668823	174
SAC-3P-M 8MS/0,3-PUR/M12FR	1682346	174	SAC-3P-M12MR/0,6-PUR/M 8FR	1668920	174	SAC-3P-M12MS/1,0-961/M12FS VA	1419104	414	SAC-3P-M12MS/3,0-PUR/M12FR-2L	1668467	174
SAC-3P-M 8MS/0,3-PUR/M12FS	1682304	174	SAC-3P-M12MR/0,6-PUR/M 8FS	1668881	174	SAC-3P-M12MS/1,5-800	1456734	178	SAC-3P-M12MS/3,0-PUR/M12FS	1681538	174
SAC-3P-M 8MS/0,3-PVC/M 8FR	1415886	176	SAC-3P-M12MR/0,6-PUR/M12FR B	1668645	174	SAC-3P-M12MS/1,5-800/M12FR	1456831	178	SAC-3P-M12MS/3,0-PUR/M12FS B	1668344	174
SAC-3P-M 8MS/0,3-PVC/M 8FR-2L	1415896	176	SAC-3P-M12MR/0,6-PUR/M12FS B	1668564	174	SAC-3P-M12MS/1,5-800/M12FR-2L	1456873	178	SAC-3P-M12MS/3,0-PVC	1414435	176
SAC-3P-M 8MS/0,6-PUR/M 8FR	1681952	174	SAC-3P-M12MR/0,6-PVC/M 8FR	1415539	176	SAC-3P-M12MS/1,5-800/M12FS	1456792	178	SAC-3P-M12MS/3,0-PVC/M 8FR	1415533	176
SAC-3P-M 8MS/0,6-PUR/M 8FR-2L	1681994	174	SAC-3P-M12MR/0,6-PVC/M 8FS	1415535	176	SAC-3P-M12MS/1,5-PUR SH	1682650	179	SAC-3P-M12MS/3,0-PVC/M 8FS	1415529	176
SAC-3P-M 8MS/0,6-PUR/M12FR	1682359	174	SAC-3P-M12MR/1,5-PUR	1668137	174	SAC-3P-M12MS/1,5-PUR/M12FR	1681567	174	SAC-3P-M12MS/3,0-PVC/M12FS	1414579	176
SAC-3P-M 8MS/0,6-P											

Index

Alphabetical

Type	Order No.	Page	Type	Order No.	Page	Type	Order No.	Page	Type	Order No.	Page
SAC-3P-M12Y/2X0,3-PUR/M12FR2LB	1669039	236	SAC-3P-MR/0,6-PUR/CI-1L-Z SCO	1435645	214	SAC-3P-Y/2X10,0-PUR SCO	1524239	236	SAC-4P-5,0-PUR/M12FR	1668247	180
SAC-3P-M12Y/2X0,3-PUR/M12FS B	1668959	236	SAC-3P-MR/1,5-PUR/A-1L-Z SCO	1434950	214	SAC-3P-Y/2XFS B PE SCO	1523968	238	SAC-4P-5,0-PUR/M12FR SH	1668292	185
SAC-3P-M12Y/2X0,6-PUR/M 8FR	1671386	236	SAC-3P-MR/1,5-PUR/B-1L-Z SCO	1435357	214	SAC-3P-Y/2XFS PE SCO	1523971	238	SAC-4P-5,0-PUR/M12FR-3L	1668302	180
SAC-3P-M12Y/2X0,6-PUR/M 8FR-2L	1671425	236	SAC-3P-MR/1,5-PUR/BI-1L-Z SCO	1435205	214	SAC-3P-Y/2XM 8FS SCO	1523984	238	SAC-4P-5,0-PUR/M12FS	1668124	180
SAC-3P-M12Y/2X0,6-PUR/M 8FS	1671344	236	SAC-3P-MR/1,5-PUR/CI-1L-Z SCO	1435506	214	SAC-4P-1,0-PUR/FRS PE SCO	1408848	272	SAC-4P-5,0-PUR/M12FS SH	1682867	185
SAC-3P-M12Y/2X0,6-PUR/M12FR B	1669000	236	SAC-3P-MR/1,5-PUR/CI-1L-Z SCO	1435658	214	SAC-4P-1,0-PUR/FRT SCO	1408827	274	SAC-4P-5,0-PUR/M12FS-2L	1694826	180
SAC-3P-M12Y/2X0,6-PUR/M12FR2LB	1669042	236	SAC-3P-MR/3,0-PUR/A-1L-Z SCO	1434963	214	SAC-4P-1,0-PUR/FSS PE SCO	1408843	272	SAC-4P-5,0-PUR/M5FR	1530566	170
SAC-3P-M12Y/2X0,6-PUR/M12FS B	1668962	236	SAC-3P-MR/3,0-PUR/B-1L-Z SCO	1435360	214	SAC-4P-1,0-PUR/FST SCO	1408823	274	SAC-4P-5,0-PUR/M5FS	1530485	170
SAC-3P-M12Y/2X1,5-PUR	1669686	236	SAC-3P-MR/3,0-PUR/BI-1L-Z SCO	1435218	214	SAC-4P-1,5-800/M12FR	1456954	184	SAC-4P-5,0-PVC/M 8FR	1403254	182
SAC-3P-M12Y/2X1,5-PUR/M 8FR	1671399	236	SAC-3P-MR/3,0-PUR/CI-1L-Z SCO	1435519	214	SAC-4P-1,5-800/M12FR-3L	1456996	184	SAC-4P-5,0-PVC/M 8FS	1567355	182
SAC-3P-M12Y/2X1,5-PUR/M 8FR-2L	1671438	236	SAC-3P-MR/3,0-PUR/CI-1L-Z SCO	1435661	214	SAC-4P-1,5-800/M12FS	1456938	184	SAC-4P-5,0-PVC/M12FR	1693539	182
SAC-3P-M12Y/2X1,5-PUR/M 8FS	1671357	236	SAC-3P-MR/A-1L-Z SCO	1458538	242	SAC-4P-1,5-PUR/DTFS	1415007	230	SAC-4P-5,0-PVC/M12FR-3L	1404961	182
SAC-3P-M12Y/2X1,5-PUR/M12FR B	1669013	236	SAC-3P-MR/B-1L-Z SCO	1458554	243	SAC-4P-1,5-PUR/M 8FR	1681871	180	SAC-4P-5,0-PVC/M12FS	1404408	182
SAC-3P-M12Y/2X1,5-PUR/M12FR2LB	1669055	236	SAC-3P-MR/BI-1L-Z SCO	1458570	243	SAC-4P-1,5-PUR/M 8FR SH	1521960	185	SAC-4P-5,0-PVC/M12FS-2L	1415602	182
SAC-3P-M12Y/2X1,5-PUR/M12FS B	1668975	236	SAC-3P-MRS/1,0-PVC PE SCO	1411640	271	SAC-4P-1,5-PUR/M 8FS	1681842	180	SAC-4P-10,0-186/FS SCO	1555664	428
SAC-3P-M12Y/2X10,0-PUR	1694473	236	SAC-3P-MRS/2,0-PVC PE SCO	1411641	271	SAC-4P-1,5-PUR/M 8FS SH	1521915	185	SAC-4P-10,0-800/M12FR	1456983	184
SAC-3P-M12Y/2X3,0-PUR	1669699	236	SAC-3P-MRS/5,0-PVC PE SCO	1411642	271	SAC-4P-1,5-PUR/M12FR	1668221	180	SAC-4P-10,0-800/M12FR-3L	1567364	184
SAC-3P-M12Y/2X3,0-PUR/M 8FR	1671409	236	SAC-3P-MRS/10,0-PVC PE SCO	1411643	271	SAC-4P-1,5-PUR/M12FR SH	1682906	185	SAC-4P-10,0-800/M12FR	1567335	182
SAC-3P-M12Y/2X3,0-PUR/M 8FR-2L	1671441	236	SAC-3P-MS A SCO/.....	1400895	224	SAC-4P-1,5-PUR/M12FR-3L	1668289	180	SAC-4P-10,0-960/M12FS VA	1431238	422
SAC-3P-M12Y/2X3,0-PUR/M 8FS	1671360	236	SAC-3P-MS A-1L-V SCO/.....	1400874	216	SAC-4P-1,5-PUR/M12FS	1668108	180	SAC-4P-10,0-960/MINFR VA	1429282	422
SAC-3P-M12Y/2X3,0-PUR/M12FR B	1669026	236	SAC-3P-MS A-1L-Z SCO/.....	1434923	214	SAC-4P-1,5-PUR/M12FS SH	1682841	185	SAC-4P-10,0-960/MINFS VAL	1429198	422
SAC-3P-M12Y/2X3,0-PUR/M12FR2LB	1669068	236	SAC-3P-MS-B SCO/.....	1400903	224	SAC-4P-1,5-PUR/M12FS-2L	1694800	180	SAC-4P-10,0-961/MINFR VA	1433896	421
SAC-3P-M12Y/2X3,0-PUR/M12FS B	1668988	236	SAC-3P-MS-B-1L-V SCO/.....	1400880	216	SAC-4P-1,5-PUR/M5FR	1530540	170	SAC-4P-10,0-961/MINFS VAL	1433809	421
SAC-3P-M12Y/2X5,0-PUR	1669754	236	SAC-3P-MS-B-1L-Z SCO/.....	1435328	214	SAC-4P-1,5-PUR/M5FS	1530469	170	SAC-4P-10,0-PUR/DTFS	1415011	230
SAC-3P-M12Y/2XM 8FS	1683471	238	SAC-3P-MS-BI SCO/.....	1400900	224	SAC-4P-1,5-PVC/M 8FR	1415552	182	SAC-4P-10,0-PUR/FRS PE SCO	1408854	272
SAC-3P-M12Y/2XM 8FS VP	1683549	239	SAC-3P-MS-BI-1L-V SCO/.....	1400877	216	SAC-4P-1,5-PUR/M 8FS	1415550	182	SAC-4P-10,0-PUR/FRT SCO	1408830	274
SAC-3P-M12Y/2XM12FS 3L	1403627	238	SAC-3P-MS-BI-1L-Z SCO/.....	1435179	214	SAC-4P-1,5-PVC/M12FR	1415606	182	SAC-4P-10,0-PUR/FSS PE SCO	1408846	272
SAC-3P-M12Y/2XM12FS B PE	1683413	238	SAC-3P-MS-C SCO/.....	1400919	224	SAC-4P-1,5-PUR/M12FR-3L	1415609	182	SAC-4P-10,0-PUR/DTFS	1408826	274
SAC-3P-M12Y/2XM12FS B PE S21	1514016	238	SAC-3P-MS-C-1L-V SCO/.....	1400892	216	SAC-4P-1,5-PVC/M12FS	1544976	182	SAC-4P-10,0-PUR/M 8FR	1694172	180
SAC-3P-M12Y/2XM12FS PE	1683455	238	SAC-3P-MS-C-1L-Z SCO/.....	1435629	214	SAC-4P-1,5-PVC/M12FS-2L	1415596	182	SAC-4P-10,0-PUR/M 8FR SH	1521999	185
SAC-3P-M12Y/2XM12FS PE S21	1511739	238	SAC-3P-MS-CI SCO/.....	1400916	224	SAC-4P-2,0-186/FS SCO	1555648	428	SAC-4P-10,0-PUR/M 8FS	1668348	180
SAC-3P-M5MR/1,5-PUR	1530346	170	SAC-3P-MS-CI-1L-V SCO/.....	1400889	216	SAC-4P-2,0-960/M12FS VA	1431212	422	SAC-4P-10,0-PUR/M 8FS SH	1521944	185
SAC-3P-M5MR/3,0-PUR	1530359	170	SAC-3P-MS-CI-1L-Z SCO/.....	1435470	214	SAC-4P-2,0-960/MINFR VA	1429266	422	SAC-4P-10,0-PUR/M12FR	1681389	180
SAC-3P-M5MR/5,0-PUR	1530362	170	SAC-3P-MS/0,3-PUR/A-1L-Z SCO	1434882	214	SAC-4P-2,0-960/MINFS VAL	1429712	422	SAC-4P-10,0-PUR/M12FR SH	1500729	185
SAC-3P-M5MR/10,0-PUR	1530375	170	SAC-3P-MS/0,3-PUR/B-1L-Z SCO	1435289	214	SAC-4P-2,0-961/MINFR VA	1433870	421	SAC-4P-10,0-PUR/M12FR-3L	1681020	180
SAC-3P-M5MS/1,5-PUR	1530265	170	SAC-3P-MS/0,3-PUR/BI-1L-Z SCO	1435137	214	SAC-4P-2,0-961/MINFS VAL	1433786	421	SAC-4P-10,0-PUR/M12FS	1681302	180
SAC-3P-M5MS/3,0-PUR	1530278	170	SAC-3P-MS/0,3-PUR/CI-1L-Z SCO	1435438	214	SAC-4P-2,0-PUR/FRS PE SCO	1408852	272	SAC-4P-10,0-PUR/M12FS SH	1500716	185
SAC-3P-M5MS/5,0-PUR	1530281	170	SAC-3P-MS/0,3-PUR/CI-1L-Z SCO	1435580	214	SAC-4P-2,0-PUR/FRT SCO	1408828	274	SAC-4P-10,0-PUR/M12FS-2L	1694839	180
SAC-3P-M5MS/10,0-PUR	1530294	170	SAC-3P-MS/0,6-PUR/A-1L-Z SCO	1434895	214	SAC-4P-2,0-PUR/FSS PE SCO	1408844	272	SAC-4P-10,0-PUR/M5FR	1530579	170
SAC-3P-M8Y/2X 1,5-PUR	1458622	234	SAC-3P-MS/0,6-PUR/B-1L-Z SCO	1435292	214	SAC-4P-2,0-PUR/FST SCO	1408824	274	SAC-4P-10,0-PUR/M5FS	1530498	170
SAC-3P-M8Y/2X 3,0-PUR	1458635	234	SAC-3P-MS/0,6-PUR/BI-1L-Z SCO	1435140	214	SAC-4P-3,0-800/M12FR	1456967	184	SAC-4P-10,0-PVC/M 8FR	1401064	182
SAC-3P-M8Y/2X 5,0-PUR	1458648	234	SAC-3P-MS/0,6-PUR/CI-1L-Z SCO	1435441	214	SAC-4P-3,0-800/M12FR-3L	1457005	184	SAC-4P-10,0-PVC/M 8FS	1401062	182
SAC-3P-M8Y/2X0,3-PUR/M 8FR	1458703	234	SAC-3P-MS/0,6-PUR/CI-1L-Z SCO	1435593	214	SAC-4P-3,0-800/M12FS	1456941	184	SAC-4P-10,0-PVC/M12FR	1415608	182
SAC-3P-M8Y/2X0,3-PUR/M 8FR-2L	1458745	234	SAC-3P-MS/1,5-PUR/A-1L-Z SCO	1434905	214	SAC-4P-3,0-PUR/DTFS	1415008	230	SAC-4P-10,0-PVC/M12FR-3L	1401063	182
SAC-3P-M8Y/2X0,3-PUR/M 8FS	1458664	234	SAC-3P-MS/1,5-PUR/B-1L-Z SCO	1435302	214	SAC-4P-3,0-PUR/M 8FR	1681884	180	SAC-4P-10,0-PVC/M12FS	1446333	182
SAC-3P-M8Y/2X0,6-PUR/M 8FR	1458716	234	SAC-3P-MS/1,5-PUR/BI-1L-Z SCO	1435153	214	SAC-4P-3,0-PUR/M 8FR SH	1521973	185	SAC-4P-10,0-PVC/M12FS-2L	1415605	182
SAC-3P-M8Y/2X0,6-PUR/M 8FR-2L	1458758	234	SAC-3P-MS/1,5-PUR/CI-1L-Z SCO	1435454	214	SAC-4P-3,0-PUR/M 8FS	1681855	180	SAC-4P-10,0-PUR/0,25	1501692	282
SAC-3P-M8Y/2X0,6-PUR/M 8FS	1458677	234	SAC-3P-MS/1,5-PUR/CI-1L-Z SCO	1435603	214	SAC-4P-3,0-PUR/M 8FS SH	1521928	185	SAC-4P-100,0-PUR/0,34	1501663	282
SAC-3P-M8Y/2X1,5-PUR/M 8FR	1458729	234	SAC-3P-MS/3,0-PUR/A-1L-Z SCO	1434918	214	SAC-4P-3,0-PUR/M12FR	1668234	180	SAC-4P-100,0-PUR/SH-0,25	1535794	283
SAC-3P-M8Y/2X1,5-PUR/M 8FR-2L	1458761	234	SAC-3P-MS/3,0-PUR/B-1L-Z SCO	1435315	214	SAC-4P-3,0-PUR/M12FR SH	1682919	185	SAC-4P-100,0-PUR/SH-0,34	1501715	283
SAC-3P-M8Y/2X1,5-PUR/M 8FS	1458860	234	SAC-3P-MS/3,0-PUR/BI-1L-Z SCO	1435166	214	SAC-4P-3,0-PUR/M12FR	1668292	180	SAC-4P-100,0-PVC/0,25	1501867	282
SAC-3P-M8Y/2X10,0-PUR	1458651	234	SAC-3P-MS/3,0-PUR/CI-1L-Z SCO	1435467	214	SAC-4P-3,0-PUR/M12FS	1668111	180	SAC-4P-100,0-PVC/0,34	1501838	282
SAC-3P-M8Y/2X3,0-PUR/M 8FR	1458732	234	SAC-3P-MS/3,0-PUR/CI-1L-Z SCO	1435616	214	SAC-4P-3,0-PUR/M12FS SH	1682854	185	SAC-4P-15,0-186/FS SCO	1555677	428
SAC-3P-M8Y/2X3,0-PUR/M 8FR-2L	1458774	234	SAC-3P-MS/A-1L-Z SCO	1458525	242	SAC-4P-3,0-PUR/M12FS-2L	1694813	180	SAC-4P-15,0-960/M12FS VA	1431241	422
SAC-3P-M8Y/2X3,0-PUR/M 8FS	1458693	234	SAC-3P-MS/B-1L-Z SCO	1458541	243	SAC-4P-3,0-PUR/M5FR	1530553	170	SAC-4P-15,0-960/MINFR VA	1429295	422
SAC-3P-MINT/2XMIN VP	1412393	241	SAC-3P-MS/BI-1L-Z SCO	1458567	243	SAC-4P-3,0-PUR/M5FS	1530472	170	SAC-4P-15,0-960/MINFR VA	1429295	422
SAC-3P-MR-A SCO/.....	1400896	224	SAC-3P-MSS/1,0-PVC PE SCO	1411636	271	SAC-4P-3,0-PVC/M 8FR	1415554	182	SAC-4P-15,0-960/MINFS VAL	1429208	422
SAC-3P-MR-A-1L-V SCO/.....	1400875	216	SAC-3P-MSS/2,0-PVC PE SCO	1411637	271	SAC-4P-3,0-PVC/M 8FS	1415551	182	SAC-4P-20,0-960/MINFR VA	1429305	422
SAC-3P-MR-A-1L-Z SCO/.....	1434976	214	SAC-3P-MSS/5,0-PVC PE SCO	1411638	271	SAC-4P-3,0-PUR/M12FR	1693526	182	SAC-4P-20,0-960/MINFS VAL	1429211	422
SAC-3P-MR-B SCO/.....	1400905	224	SAC-3P-MSS/10,0-PVC PE SCO	1411639	271	SAC-4P-3,0-PVC/M12FR-3L	1415610	182	SAC-4P-25,0-960/MINFR VA	1429318	422
SAC-3P-MR-B-1L-V SCO/.....	1400881	216	SAC-3P-PUR-0,25-SH/...	1408511	283	SAC-4P-3,0-PVC/M12FS	1404407	182	SAC-4P-25,0-960/MINFS VAL	1429224	422
SAC-3P-MR-B-1L-Z SCO/.....	1435373	214	SAC-3P-PUR-0,25/...	1408505	283	SAC-4P-3,0-PVC/M12FS-2L	1415597	182	SAC-4P-3,0-PUR/AD	1438956	228
SAC-3P-MR-BI SCO/.....	1400901	224	SAC-3P-PUR-0,34-SH/...	1408512	283	SAC-4P-5,0-186/FS SCO	1555651	428	SAC-4P-30,0-960/MINFR VA	1429321	422
SAC-3P-MR-BI-1L-V SCO/.....	1400878	216	SAC-3P-PUR-0,34/...	1408506	283	SAC-4P-5,0-800/M12FR	1456970	184	SAC-4P-30,0-960/MINFS VAL	1429237	422
SAC-3P-MR-BI-1L-Z SCO/.....	1435221	214	SAC-3P-PUR-0,5/...	1408529	284	SAC-4P-5,0-800/M12FR-3L	1567351	184	SAC-4P-40,0-960/MINFR VA	1429334	422
SAC-3P-MR-C SCO/.....	1400920	224	SAC-3P-PVC-0,25/...	1408518	283	SAC-4P-5,0-800/M12FS	1567322	184	SAC-4P-40,0-960/MINFS VAL	1429240	422
SAC-3P-MR-C-1L-V SCO/.....	1400893	216	SAC-3P-PVC-0,34-SH/...	1408525	283	S					

Index

Alphabetical

Type	Order No.	Page	Type	Order No.	Page	Type	Order No.	Page	Type	Order No.	Page
SAC-4P-MINMS/0,3-960/MINFSVAL	1429538	422	SAC-4P-MS/10,0-186/FS SCO	1555732	428	SAC-5P-3,0-440/MINFR PWR	1443763	276	SAC-5P-10,0-923/MINFS DN	1418442	418
SAC-4P-MINMS/0,3-961/MINFRVAL	1434387	421	SAC-4P-MS/15,0-186 SCO	1555635	428	SAC-5P-3,0-440/MINFS PWR	1443718	276	SAC-5P-10,0-928/MINFR DN	1417524	419
SAC-4P-MINMS/0,5-961/MINFSVAL	1434141	421	SAC-4P-MS/15,0-186/FS SCO	1555745	428	SAC-5P-3,0-441/MINFR PWR	1443967	277	SAC-5P-10,0-928/MINFS DN	1417472	419
SAC-4P-MINMS/0,5-960/MINFRVAL	1429790	422	SAC-4P-MS/A-1L-Z D SCO	1458583	243	SAC-5P-3,0-441/MINFS PWR	1443912	277	SAC-5P-10,0-PUR/AD-2L	1435111	226
SAC-4P-MINMS/0,5-960/MINFSVAL	1429554	422	SAC-4P-MSS/1,0-PUR PE SCO	1408835	272	SAC-5P-3,0-802/M12FR	1457186	189	SAC-5P-10,0-PUR/M12FR	1694541	187
SAC-4P-MINMS/0,5-961/MINFRVAL	1434390	421	SAC-4P-MSS/1,5-PUR PE SH SCO	1424104	273	SAC-5P-3,0-802/M12FR-3L	1457212	189	SAC-5P-10,0-PUR/M12FR SH	1500761	190
SAC-4P-MINMS/0,5-961/MINFSVAL	1434154	421	SAC-4P-MSS/2,0-PUR PE SCO	1408836	272	SAC-5P-3,0-802/M12FS	1457160	189	SAC-5P-10,0-PUR/M12FR-3L	1694431	187
SAC-4P-MINMS/1,0-960/MINFRVAL	1429800	422	SAC-4P-MSS/3,0-PUR PE SH SCO	1424105	273	SAC-5P-3,0-PUR/AD-2L	1435098	226	SAC-5P-10,0-PUR/M12FS	1683374	187
SAC-4P-MINMS/1,0-960/MINFSVAL	1429567	422	SAC-4P-MSS/5,0-PUR PE SCO	1408837	272	SAC-5P-3,0-PUR/M12FR	1669864	187	SAC-5P-10,0-PUR/M12FS SH	1500758	190
SAC-4P-MINMS/1,0-961/MINFRVAL	1434400	421	SAC-4P-MSS/5,0-PUR PE SH SCO	1424245	273	SAC-5P-3,0-PUR/M12FR SH	1682977	190	SAC-5P-10,0-PVC/0,34	1438671	227
SAC-4P-MINMS/1,0-961/MINFSVAL	1434167	421	SAC-4P-MSS/10,0-PUR PE SCO	1408838	272	SAC-5P-3,0-PUR/M12FR-3L	1669893	187	SAC-5P-10,0-PVC/M12FR	1415689	188
SAC-4P-MINMS/2,0-960 VAL	1429350	422	SAC-4P-MSS/10,0-PUR PE SH SCO	1424107	273	SAC-5P-3,0-PUR/M12FS	1669835	187	SAC-5P-10,0-PVC/M12FR-3L	1415694	188
SAC-4P-MINMS/2,0-960/MINFRVAL	1429813	422	SAC-4P-MST/1,0-PUR SCO	1408812	274	SAC-5P-3,0-PUR/M12FS SH	1682948	190	SAC-5P-10,0-PVC/M12FS	1415685	188
SAC-4P-MINMS/2,0-960/MINFSVAL	1429570	422	SAC-4P-MST/1,0-PUR/FST SCO	1408808	274	SAC-5P-3,0-PVC/AD-2L	1415946	227	SAC-5P-100,0-PVC/0,34	1457445	284
SAC-4P-MINMS/2,0-961 VAL	1433964	421	SAC-4P-MST/1,5-PUR SH SCO	1424120	275	SAC-5P-3,0-PVC/M12FR	1415687	188	SAC-5P-100,0-PUR/0,34	1501676	282
SAC-4P-MINMS/2,0-961/MINFRVAL	1434413	421	SAC-4P-MST/2,0-PUR SCO	1408813	274	SAC-5P-3,0-PVC/M12FR-3L	1415691	188	SAC-5P-100,0-PUR/0,5	1457403	284
SAC-4P-MINMS/2,0-961/MINFSVAL	1434170	421	SAC-4P-MST/2,0-PUR/FST SCO	1408809	274	SAC-5P-3,0-PVC/M12FS	1415688	188	SAC-5P-100,0-PUR/SH/0,34	1501728	283
SAC-4P-MINMS/5,0-960 VAL	1429442	422	SAC-4P-MST/3,0-PUR SH SCO	1424121	275	SAC-5P-5,0-115/M 8FRB	1404477	186	SAC-5P-100,0-PVC/SH/0,34	1518245	282
SAC-4P-MINMS/5,0-960/MINFRVAL	1429826	422	SAC-4P-MST/5,0-PUR SCO	1408814	274	SAC-5P-5,0-115/M 8FSB	1404473	186	SAC-5P-100,0-PVC/SH/0,34	1550672	283
SAC-4P-MINMS/5,0-960/MINFSVAL	1429583	422	SAC-4P-MST/5,0-PUR SH SCO	1424122	275	SAC-5P-5,0-430/MINFR PWR	1443378	278	SAC-5P-15,0-900/FSB SCO	1517945	412
SAC-4P-MINMS/5,0-961 VAL	1433977	421	SAC-4P-MST/5,0-PUR/FST SCO	1408810	274	SAC-5P-5,0-430/MINFS PWR	1443323	278	SAC-5P-15,0-900/M12FSB	1507146	412
SAC-4P-MINMS/5,0-961/MINFRVAL	1434426	421	SAC-4P-MST/10,0-PUR SCO	1408815	274	SAC-5P-5,0-431/MINFR PWR	1443572	279	SAC-5P-15,0-920/FS SCO	1518245	417
SAC-4P-MINMS/5,0-961/MINFSVAL	1434183	421	SAC-4P-MST/10,0-PUR SH SCO	1424123	275	SAC-5P-5,0-431/MINFS PWR	1443527	279	SAC-5P-15,0-920/M 8FS	1575806	416
SAC-4P-MINMS/10,0-960 VAL	1429376	422	SAC-4P-MST/10,0-PUR/FST SCO	1408811	274	SAC-5P-5,0-440/MINFR PWR	1443776	276	SAC-5P-15,0-920/M12FS	1507502	417
SAC-4P-MINMS/10,0-960/MINFRVAL	1429839	422	SAC-4P-PUR-0,25-SH/...	1408513	283	SAC-5P-5,0-440/MINFS PWR	1443721	276	SAC-5P-15,0-923/FR CAN SCO	1419037	415
SAC-4P-MINMS/10,0-960/MINFSVAL	1429596	422	SAC-4P-PUR-0,25/...	1408507	283	SAC-5P-5,0-441/MINFR PWR	1443970	277	SAC-5P-15,0-923/FS CAN SCO	1419032	415
SAC-4P-MINMS/10,0-961 VAL	1433980	421	SAC-4P-PUR-0,34-SH/...	1408514	283	SAC-5P-5,0-441/MINFS PWR	1443925	277	SAC-5P-15,0-923/MINFR DN	1418507	418
SAC-4P-MINMS/10,0-961/MINFRVAL	1434439	421	SAC-4P-PUR-0,34/...	1408508	283	SAC-5P-5,0-802/M12FR	1457199	189	SAC-5P-15,0-923/MINFS DN	1418455	418
SAC-4P-MINMS/10,0-961/MINFSVAL	1434196	421	SAC-4P-PVC-0,25/...	1408521	283	SAC-5P-5,0-802/M12FR-3L	1454370	189	SAC-5P-15,0-928/MINFR DN	1417537	419
SAC-4P-MINMS/15,0-960 VAL	1429389	422	SAC-4P-PVC-0,34-SH/...	1408526	283	SAC-5P-5,0-802/M12FS	1454422	189	SAC-5P-15,0-928/MINFS DN	1417485	419
SAC-4P-MINMS/15,0-960/MINFRVAL	1429842	422	SAC-4P-PVC-0,34/...	1408522	283	SAC-5P-5,0-900/FSB SCO	1517929	412	SAC-5P-20,0-923/FR CAN SCO	1419038	415
SAC-4P-MINMS/15,0-960/MINFSVAL	1429606	422	SAC-4PY-1,5-PUR/2XF	1436255	235	SAC-5P-5,0-900/M12FSB	1507120	412	SAC-5P-20,0-923/FS CAN SCO	1419033	415
SAC-4P-MINMS/20,0-960 VAL	1429392	422	SAC-4PY-3,0-PUR/2XF	1436178	235	SAC-5P-5,0-920/FS SCO	1518229	417	SAC-5P-20,0-923/MINFR DN	1418510	418
SAC-4P-MINMS/20,0-960/MINFRVAL	1429855	422	SAC-4PY-5,0-PUR/2XF	1436181	235	SAC-5P-5,0-920/M 8FS	1575783	416	SAC-5P-20,0-923/MINFS DN	1418468	418
SAC-4P-MINMS/20,0-960/MINFSVAL	1429619	422	SAC-4PY-10,0-PUR/2XF	1436194	235	SAC-5P-5,0-920/M12FS	1507489	417	SAC-5P-20,0-928/MINFR DN	1417540	419
SAC-4P-MINMS/25,0-960 VAL	1429402	422	SAC-4PY-MS-0,3-PUR/2XF	1436204	235	SAC-5P-5,0-923/FR CAN SCO	1419035	415	SAC-5P-20,0-928/MINFS DN	1417498	419
SAC-4P-MINMS/25,0-960/MINFRVAL	1429868	422	SAC-4PY-MS-0,6-PUR/2XF	1436217	235	SAC-5P-5,0-923/FS CAN SCO	1419030	415	SAC-5P-920/...	1511504	417
SAC-4P-MINMS/25,0-960/MINFSVAL	1429622	422	SAC-4PY-MS-1,5-PUR/2XF	1436220	235	SAC-5P-5,0-923/MINFR DN	1418484	418	SAC-5P-AD-2L/...	1435124	226
SAC-4P-MINMS/30,0-960 VAL	1429415	422	SAC-4PY-MS-3,0-PUR/2XF	1436233	235	SAC-5P-5,0-923/MINFS DN	1418439	418	SAC-5P-FR SCO/920/...	1433294	417
SAC-4P-MINMS/30,0-960/MINFRVAL	1429871	422	SAC-4PY-MT/2XFT VP	1410632	280	SAC-5P-5,0-928/MINFR DN	1417511	419	SAC-5P-FRB SCO/900/...	1433197	412
SAC-4P-MINMS/30,0-960/MINFSVAL	1429635	422	SAC-5P-1,5-115/M 8FRB	1404475	186	SAC-5P-5,0-928/MINFS DN	1417469	419	SAC-5P-FS SCO/920/...	1538131	417
SAC-4P-MINMS/40,0-960 VAL	1429428	422	SAC-5P-1,5-115/M 8FSB	1404470	186	SAC-5P-5,0-PUR/AD-2L	1435108	226	SAC-5P-FSB SCO/900/...	1538018	412
SAC-4P-MINMS/40,0-960/MINFRVAL	1429884	422	SAC-5P-1,5-430/MINFR PWR	1443352	278	SAC-5P-5,0-PUR/M12FR	1669877	187	SAC-5P-M 8FR/920/...	1575916	416
SAC-4P-MINMS/40,0-960/MINFSVAL	1429648	422	SAC-5P-1,5-430/MINFS PWR	1443307	278	SAC-5P-5,0-PUR/M12FR SH	1682980	190	SAC-5P-M 8FS/920/...	1575819	416
SAC-4P-MINMS/50,0-960 VAL	1429431	422	SAC-5P-1,5-431/MINFR PWR	1443556	279	SAC-5P-5,0-PUR/M12FR-3L	1669903	187	SAC-5P-M 8MR/M 8FR/920/...	1575945	416
SAC-4P-MINMS/50,0-960/MINFRVAL	1429897	422	SAC-5P-1,5-431/MINFS PWR	1443501	279	SAC-5P-5,0-PUR/M12FS	1669848	187	SAC-5P-M 8MR/M 8FS/920/...	1575932	416
SAC-4P-MINMS/50,0-960/MINFSVAL	1429651	422	SAC-5P-1,5-440/MINFR PWR	1443750	276	SAC-5P-5,0-PUR/M12FS SH	1682951	190	SAC-5P-M 8MR/920/...	1575903	416
SAC-4P-MRS/1,0-PUR PE SCO	1408839	272	SAC-5P-1,5-440/MINFS PWR	1443705	276	SAC-5P-5,0-PVC/AD-2L	1438639	227	SAC-5P-M 8MRB/1,5-115	1404465	186
SAC-4P-MRS/1,5-PUR PE SH SCO	1424108	273	SAC-5P-1,5-441/MINFR PWR	1443954	277	SAC-5P-5,0-PVC/M12FR	1415688	188	SAC-5P-M 8MRB/3,0-115	1404466	186
SAC-4P-MRS/2,0-PUR PE SCO	1408840	272	SAC-5P-1,5-441/MINFS PWR	1443909	277	SAC-5P-5,0-PVC/M12FR-3L	1415693	188	SAC-5P-M 8MRB/5,0-115	1404467	186
SAC-4P-MRS/3,0-PUR PE SH SCO	1424109	273	SAC-5P-1,5-802/M12FR	1457173	189	SAC-5P-5,0-PVC/M12FS	1453889	188	SAC-5P-M 8MRB/10,0-115	1404468	186
SAC-4P-MRS/5,0-PUR PE SCO	1408841	272	SAC-5P-1,5-802/M12FR-3L	1454367	189	SAC-5P-7,5-430/MINFR PWR	1443381	278	SAC-5P-M 8MS DN TR	1435988	425
SAC-4P-MRS/5,0-PUR PE SH SCO	1424110	273	SAC-5P-1,5-802/M12FS	1454419	189	SAC-5P-7,5-430/MINFS PWR	1443336	278	SAC-5P-M 8MS-M 8FS/920/...	1575893	416
SAC-4P-MRS/10,0-PUR PE SCO	1408842	272	SAC-5P-1,5-PUR/AD-2L	1435085	226	SAC-5P-7,5-431/MINFR PWR	1443585	279	SAC-5P-M 8MS/0,3-920/M 8FS	1575822	416
SAC-4P-MRS/10,0-PUR PE SH SCO	1424111	273	SAC-5P-1,5-PUR/M12FR	1669851	187	SAC-5P-7,5-431/MINFS PWR	1443530	279	SAC-5P-M 8MS/0,5-920/M 8FS	1575835	416
SAC-4P-MRT/1,0-PUR SCO	1408816	274	SAC-5P-1,5-PUR/M12FR SH	1682964	190	SAC-5P-7,5-440/MINFR PWR	1443789	276	SAC-5P-M 8MS/1,0-920/M 8FS	1575848	416
SAC-4P-MRT/1,0-PUR/FRT SCO	1415196	274	SAC-5P-1,5-PUR/M12FR-3L	1669880	187	SAC-5P-7,5-440/MINFS PWR	1443734	276	SAC-5P-M 8MS/2,0-920	1575712	416
SAC-4P-MRT/1,5-PUR SH SCO	1424124	275	SAC-5P-1,5-PUR/M12FS	1669822	187	SAC-5P-7,5-441/MINFR PWR	1419807	277	SAC-5P-M 8MS/2,0-920/M 8FS	1575851	416
SAC-4P-MRT/1,5-PUR/FRT SH SCO	1415202	275	SAC-5P-1,5-PUR/M12FS SH	1682935	190	SAC-5P-7,5-441/MINFS PWR	1443938	277	SAC-5P-M 8MS/5,0-920	1575725	416
SAC-4P-MRT/10,0-PUR/FRT SCO	1415199	274	SAC-5P-1,5-PVC/AD-2L	1415945	227	SAC-5P-10,0-115/M 8FRB	1404478	186	SAC-5P-M 8MS/5,0-920/M 8FS	1575864	416
SAC-4P-MRT/10,0-PUR/FRT SH SCO	1415205	275	SAC-5P-1,5-PVC/M12FR	1415686	188	SAC-5P-10,0-115/M 8FSB	1404474	186	SAC-5P-M 8MS/10,0-920	1575738	416
SAC-4P-MRT/2,0-PUR SCO	1408819	274	SAC-5P-1,5-PVC/M12FR-3L	1415690	188	SAC-5P-10,0-430/MINFR PWR	1443394	278	SAC-5P-M 8MS/10,0-920/M 8FS	1575877	416
SAC-4P-MRT/2,0-PUR/FRT SCO	1415197	274	SAC-5P-1,5-PVC/M12FS	1415683	188	SAC-5P-10,0-430/MINFS PWR	1443349	278	SAC-5P-M 8MS/15,0-920	1575754	416
SAC-4P-MRT/3,0-PUR SH SCO	1424125	275	SAC-5P-2,0-900/FSB SCO	1517916	412	SAC-5P-10,0-431/MINFR PWR	1443598	279	SAC-5P-M 8MS/15,0-920/M 8FS	1575880	416
SAC-4P-MRT/3,0-PUR/FRT SH SCO	1415203	275	SAC-5P-2,0-900/M12FSB	1507117	412	SAC-5P-10,0-431/MINFS PWR	1443543	279	SAC-5P-M 8MS/920/...	1575767	416
SAC-4P-MRT/5,0-PUR SCO	1408820	274	SAC-5P-2,0-920/FS SCO	1518216	417	SAC-5P-10,0-440/MINFR PWR	1443792	276	SAC-5P-M 8MSB/0,3-115/M 8FSB	1404479	186

Type	Order No.	Page	Type	Order No.	Page	Type	Order No.	Page	Type	Order No.	Page
SAC-5P-M12MR SH/.....	1697519	190	SAC-5P-M12MS/1,5-PUR/M12FR-3L	1694651	187	SAC-5P-MINMR/1,5-441/MINFR PWR	1419904	277	SAC-5P-MINMS/20,0-923 DN	1418565	418
SAC-5P-M12MR-M12FR SH/.....	1536159	190	SAC-5P-M12MS/1,5-PUR/M12FS	1681606	187	SAC-5P-MINMR/10,0-923 DN	1418594	418	SAC-5P-MINMS/20,0-923/MINFR DN	1420032	418
SAC-5P-M12MR-M12FR-3L/.....	1552159	187	SAC-5P-M12MS/1,5-PVC	1415675	188	SAC-5P-MINMR/10,0-923/MINFR DN	1420090	418	SAC-5P-MINMS/20,0-923/MINFS DN	1418691	418
SAC-5P-M12MR-M12FR/.....	1529506	187	SAC-5P-M12MS/1,5-PVC/M12FR	1415701	188	SAC-5P-MINMR/10,0-923/MINFS DN	1418756	418	SAC-5P-MINMS/20,0-928 DN	1417595	419
SAC-5P-M12MR-M12FS SH/.....	1536146	190	SAC-5P-M12MS/1,5-PVC/M12FR-3L	1415705	188	SAC-5P-MINMR/10,0-928 DN	1417621	419	SAC-5P-MINMS/20,0-928/MINFR DN	1417883	419
SAC-5P-M12MR-M12FS/.....	1508734	187	SAC-5P-M12MS/1,5-PVC/M12FS	1415697	188	SAC-5P-MINMR/10,0-928/MINFR DN	1417948	419	SAC-5P-MINMS/20,0-928/MINFS DN	1417728	419
SAC-5P-M12MR/1,5-802	1457322	189	SAC-5P-M12MS/10,0-802	1457254	189	SAC-5P-MINMR/10,0-928/MINFS DN	1417786	419	SAC-5P-MINT/2XMIN DN	1401229	424
SAC-5P-M12MR/1,5-PUR SH	1682757	190	SAC-5P-M12MS/10,0-920	1507447	417	SAC-5P-MINMR/15,0-923 DN	1418604	418	SAC-5P-MINT/2XMIN VP	1543977	241
SAC-5P-M12MR/3,0-802	1457335	189	SAC-5P-M12MS/10,0-920/M12FS	1507573	417	SAC-5P-MINMR/15,0-923/MINFR DN	1420100	418	SAC-5P-MR SCO/920/...	1433281	417
SAC-5P-M12MR/3,0-PUR SH	1682760	190	SAC-5P-M12MS/10,0-PUR	1683361	187	SAC-5P-MINMR/15,0-923/MINFS DN	1418769	418	SAC-5P-MR-FC SCO/920/...	1433320	417
SAC-5P-M12MR/5,0-802	1457348	189	SAC-5P-M12MS/10,0-PUR SH	1500732	190	SAC-5P-MINMR/15,0-928 DN	1417634	419	SAC-5P-MR-FC SCO/920/...	1433317	417
SAC-5P-M12MR/5,0-PUR SH	1682773	190	SAC-5P-M12MS/10,0-PVC	1415678	188	SAC-5P-MINMR/15,0-928/MINFR DN	1417951	419	SAC-5P-MR/0,3-923/FR CAN SCO	1419073	415
SAC-5P-M12MR/.....	1697108	187	SAC-5P-M12MS/15,0-920	1507450	417	SAC-5P-MINMR/15,0-923/MINFS DN	1417799	419	SAC-5P-MR/0,3-923/FS CAN SCO	1419057	415
SAC-5P-M12MR/1,5-PUR	1669796	187	SAC-5P-M12MS/15,0-920/M12FS	1507586	417	SAC-5P-MINMR/2,0-430/MINFR PWR	1443491	278	SAC-5P-MR/0,5-923/FR CAN SCO	1419074	415
SAC-5P-M12MR/1,5-PVC	1415679	188	SAC-5P-M12MS/3,0-PUR	1669770	187	SAC-5P-MINMR/2,0-431/MINFR PWR	1443695	279	SAC-5P-MR/0,5-923/FS CAN SCO	1419058	415
SAC-5P-M12MR/10,0-802	1457351	189	SAC-5P-M12MS/3,0-PUR/M12FR	1681651	187	SAC-5P-MINMR/2,0-440/MINFR PWR	1443899	276	SAC-5P-MR/1,0-923/FR CAN SCO	1419075	415
SAC-5P-M12MR/10,0-PUR	1694460	187	SAC-5P-M12MS/3,0-PUR/M12FS	1681619	187	SAC-5P-MINMR/2,0-441/MINFR PWR	1419917	277	SAC-5P-MR/1,0-923/FS CAN SCO	1419059	415
SAC-5P-M12MR/10,0-PUR SH	1669819	187	SAC-5P-M12MS/3,0-PVC	1415676	188	SAC-5P-MINMR/20,0-923 DN	1418617	418	SAC-5P-MR/1,0-923/FR CAN SCO	1419044	415
SAC-5P-M12MR/10,0-PVC	1415682	188	SAC-5P-M12MS/3,0-PVC/M12FR	1415702	188	SAC-5P-MINMR/20,0-923/MINFR DN	1420113	418	SAC-5P-MR/2,0-923/FR CAN SCO	1419076	415
SAC-5P-M12MR/3,0-PUR	1669806	187	SAC-5P-M12MS/3,0-PVC/M12FR-3L	1415706	188	SAC-5P-MINMR/20,0-923/MINFS DN	1418772	418	SAC-5P-MR/2,0-923/FS CAN SCO	1419060	415
SAC-5P-M12MR/3,0-PVC	1415680	188	SAC-5P-M12MS/3,0-PVC/M12FS	1415698	188	SAC-5P-MINMR/20,0-928 DN	1417647	419	SAC-5P-MR/5,0-923 CAN SCO	1419045	415
SAC-5P-M12MR/5,0-PUR	1669796	187	SAC-5P-M12MS/5,0-PUR	1669783	187	SAC-5P-MINMR/20,0-928/MINFR DN	1417964	419	SAC-5P-MR/5,0-923/FR CAN SCO	1419077	415
SAC-5P-M12MR/5,0-PVC	1415681	188	SAC-5P-M12MS/5,0-PVC	1415677	188	SAC-5P-MINMR/20,0-928/MINFS DN	1417809	419	SAC-5P-MR/5,0-923/FS CAN SCO	1419061	415
SAC-5P-M12MS CAN TR	1507816	425	SAC-5P-M12MS/920/...	1538102	417	SAC-5P-MINMS TR-DN	1434701	425	SAC-5P-MR/10,0-923 CAN SCO	1419064	415
SAC-5P-M12MS PB TR	1507803	425	SAC-5P-M12MSB-M12FSB/900/...	1538021	412	SAC-5P-MINMS/0,3-923/MINFR DN	1418785	418	SAC-5P-MR/10,0-923/FR CAN SCO	1419078	415
SAC-5P-M12MS SH/.....	1697506	190	SAC-5P-M12MSB/0,3-900/M12FSB	1507162	412	SAC-5P-MINMS/0,3-923/MINFS DN	1418620	418	SAC-5P-MR/10,0-923/FS CAN SCO	1419062	415
SAC-5P-M12MS-M12FR SH/.....	1536133	190	SAC-5P-M12MSB/0,5-900/M12FSB	1507175	412	SAC-5P-MINMS/0,3-928/MINFR DN	1417812	419	SAC-5P-MR/15,0-923 CAN SCO	1419047	415
SAC-5P-M12MS-M12FR-3L/.....	1697166	187	SAC-5P-M12MSB/1,0-900/M12FSB	1507188	412	SAC-5P-MINMS/0,3-928/MINFS DN	1417650	419	SAC-5P-MR/15,0-923/FR CAN SCO	1419079	415
SAC-5P-M12MS-M12FR/.....	1697153	187	SAC-5P-M12MSB/2,0-900	1507065	412	SAC-5P-MINMS/0,5-923/MINFR DN	1418798	418	SAC-5P-MR/15,0-923/FS CAN SCO	1419063	415
SAC-5P-M12MS-M12FS SH/.....	1536120	190	SAC-5P-M12MSB/2,0-900/M12FSB	1507191	412	SAC-5P-MINMS/0,5-923/MINFS DN	1418633	418	SAC-5P-MR/20,0-923 CAN SCO	1419048	415
SAC-5P-M12MS-M12FS/.....	1697140	187	SAC-5P-M12MSB/5,0-900	1507078	412	SAC-5P-MINMS/0,5-928/MINFR DN	1417825	419	SAC-5P-MR/20,0-923/FR CAN SCO	1419080	415
SAC-5P-M12MS-M12FS/920/...	1538144	417	SAC-5P-M12MSB/5,0-900/M12FSB	1507201	412	SAC-5P-MINMS/0,5-928/MINFS DN	1417663	419	SAC-5P-MR/20,0-923/FS CAN SCO	1419064	415
SAC-5P-M12MS/0,3-802/M12FR	1457283	189	SAC-5P-M12MSB/10,0-900	1507081	412	SAC-5P-MINMS/1,0-923/MINFR DN	1418808	418	SAC-5P-MR/AD-2L SCO	1458606	242
SAC-5P-M12MS/0,3-802/M12FR-3L	1457306	189	SAC-5P-M12MSB/10,0-900/M12FSB	1507214	412	SAC-5P-MINMS/1,0-923/MINFS DN	1418646	418	SAC-5P-MRB SCO/900/...	1433184	412
SAC-5P-M12MS/0,3-802/M12FS	1457267	189	SAC-5P-M12MSB/15,0-900	1507094	412	SAC-5P-MINMS/1,0-928/MINFR DN	1417838	419	SAC-5P-MRB-FRB SCO/900/...	1433223	412
SAC-5P-M12MS/0,3-920/M12FS	1507528	417	SAC-5P-M12MSB/15,0-900/M12FSB	1507227	412	SAC-5P-MINMS/1,0-928/MINFS DN	1417676	419	SAC-5P-MRB-FRB SCO/900/...	1433210	412
SAC-5P-M12MS/0,3-PUR/M12FR SH	1501003	190	SAC-5P-M12MSB/900/...	1537983	412	SAC-5P-MINMS/2,0-923 DN	1418523	418	SAC-5P-MS SCO/920/...	1538115	417
SAC-5P-M12MS/0,3-PUR/M12FS SH	1500894	190	SAC-5P-M12T/2XMIN1 VP	1541186	239	SAC-5P-MINMS/2,0-923/MINFR DN	1418811	418	SAC-5P-MS-AD-2L SCO/.....	1435072	226
SAC-5P-M12MS/0,5-920/M12FS	1507531	417	SAC-5P-M12T/2XMIN DN	1401028	424	SAC-5P-MINMS/2,0-923/MINFS DN	1418659	418	SAC-5P-MS-FC SCO/920/...	1433304	417
SAC-5P-M12MS/0,6-802/M12FR	1454516	189	SAC-5P-M12Y/2XMIN12FS VP	1683468	239	SAC-5P-MINMS/2,0-928 DN	1417553	419	SAC-5P-MS-FC SCO/920/...	1538157	417
SAC-5P-M12MS/0,6-802/M12FR-3L	1454464	189	SAC-5P-M12Y/2XMIN12FS VP S21	1514029	239	SAC-5P-MINMS/2,0-928/MINFR DN	1417841	419	SAC-5P-MS/0,3-920/FS SCO	1518258	417
SAC-5P-M12MS/0,6-802/M12FS	1454561	189	SAC-5P-MINMR/0,3-923/MINFR DN	1420045	418	SAC-5P-MINMS/2,0-928/MINFS DN	1417689	419	SAC-5P-MS/0,3-923/FR CAN SCO	1419065	415
SAC-5P-M12MS/0,6-PUR/M12FR SH	1501029	190	SAC-5P-MINMR/0,3-923/MINFS DN	1418701	418	SAC-5P-MINMS/5,0-923 DN	1418536	418	SAC-5P-MS/0,3-923/FS CAN SCO	1419049	415
SAC-5P-M12MS/0,6-PUR/M12FS SH	1500897	190	SAC-5P-MINMR/0,3-928/MINFR DN	1417896	419	SAC-5P-MINMS/5,0-923/MINFR DN	1418824	418	SAC-5P-MS/0,3-PUR/AD-2L SCO	1435030	226
SAC-5P-M12MS/1,0-920/M12FS	1507544	417	SAC-5P-MINMR/0,3-928/MINFS DN	1417731	419	SAC-5P-MINMS/5,0-923/MINFS DN	1418662	418	SAC-5P-MS/0,5-920/FS SCO	1518261	417
SAC-5P-M12MS/1,5-802	1457225	189	SAC-5P-MINMR/0,5-923/MINFR DN	1420058	418	SAC-5P-MINMS/5,0-928 DN	1417566	419	SAC-5P-MS/0,5-923/FR CAN SCO	1419066	415
SAC-5P-M12MS/1,5-802/M12FR	1454532	189	SAC-5P-MINMR/0,5-923/MINFS DN	1418714	418	SAC-5P-MINMS/5,0-928/MINFR DN	1417854	419	SAC-5P-MS/0,5-923/FS CAN SCO	1419050	415
SAC-5P-M12MS/1,5-802/M12FR-3L	1454480	189	SAC-5P-MINMR/0,5-928/MINFR DN	1417906	419	SAC-5P-MINMS/5,0-928/MINFS DN	1417692	419	SAC-5P-MS/0,6-PUR/AD-2L SCO	1435043	226
SAC-5P-M12MS/1,5-802/M12FS	1454587	189	SAC-5P-MINMR/0,5-928/MINFS DN	1417744	419	SAC-5P-MINMS/0,3-430/MINFS PWR	1443404	278	SAC-5P-MS/1,0-920/FS SCO	1518274	417
SAC-5P-M12MS/1,5-PUR SH	1682728	190	SAC-5P-MINMR/1,0-923/MINFR DN	1420061	418	SAC-5P-MINMS/0,3-431/MINFS PWR	1443608	279	SAC-5P-MS/1,0-923/FR CAN SCO	1419067	415
SAC-5P-M12MS/1,5-PUR/M12FR SH	1501045	190	SAC-5P-MINMR/1,0-923/MINFS DN	1418727	418	SAC-5P-MINMS/0,3-440/MINFS PWR	1443802	276	SAC-5P-MS/1,0-923/FS CAN SCO	1419051	415
SAC-5P-M12MS/1,5-PUR/M12FS SH	1500907	190	SAC-5P-MINMR/1,0-928/MINFR DN	1417919	419	SAC-5P-MINMS/0,3-441/MINFS PWR	1419823	277	SAC-5P-MS/1,5-PUR/AD-2L SCO	1435056	226
SAC-5P-M12MS/2,0-920	1507421	417	SAC-5P-MINMR/1,0-928/MINFS DN	1417757	419	SAC-5P-MINMS/0,6-430/MINFS PWR	1443417	278	SAC-5P-MS/2,0-920 SCO	1518177	417
SAC-5P-M12MS/2,0-920/M12FS	1507557	417	SAC-5P-MINMR/2,0-923 DN	1418578	418	SAC-5P-MINMS/0,6-431/MINFS PWR	1443611	279	SAC-5P-MS/2,0-920/FS SCO	1518287	417
SAC-5P-M12MS/3,0-802	1457238	189	SAC-5P-MINMR/2,0-923/MINFR DN	1420074	418	SAC-5P-MINMS/0,6-440/MINFS PWR	1443815	276	SAC-5P-MS/2,0-920/FR CAN SCO	1419039	415
SAC-5P-M12MS/3,0-802/M12FR	1457296	189	SAC-5P-MINMR/2,0-923/MINFS DN	1418730	418	SAC-5P-MINMS/0,6-441/MINFS PWR	1419836	277	SAC-5P-MS/2,0-923/FR CAN SCO	1419068	415
SAC-5P-M12MS/3,0-802/M12FR-3L	1457319	189	SAC-5P-MINMR/2,0-928 DN	1417605	419	SAC-5P-MINMS/1,0-430/MINFS PWR	1443420	278	SAC-5P-MS/2,0-923/FS CAN SCO	1419052	415
SAC-5P-M12MS/3,0-802/M12FS	1457270	189	SAC-5P-MINMR/2,0-928/MINFR DN	1417922	419	SAC-5P-MINMS/1,0-431/MINFS PWR	1443624	279	SAC-5P-MS/3,0-PUR/AD-2L SCO	1435069	226
SAC-5P-M12MS/3,0-PUR SH	1682740	190	SAC-5P-MINMR/2,0-928/MINFS DN	1417760	419	SAC-5P-MINMS/1,0-440/MINFS PWR	1443828	276	SAC-5P-MS/5,0-920 SCO	1518180	417
SAC-5P-M12MS/3,0-PUR/M12FR SH	1501058	190	SAC-5P-MINMR/5,0-923 DN	1418581	418	SAC-5P-MINMS/1,0-441/MINFS PWR	1419849	277	SAC-5P-MS/5,0-920/FS SCO	1518290	417
SAC-5P-M12MS/3,0-PUR/M12FS SH	1500910	190	SAC-5P-MINMR/5,0-923/MINFR DN	1420087	418	SAC-5P-MINMS/1,5-430/MINFS PWR	1443433	278	SAC-5P-MS/5,0-923 CAN SCO	1419040	415
SAC-5P-M12MS/5,0-802	1457241	189	SAC-5P-MINMR/5,0-923/MINFS DN	1418743	418	SAC-5P-MINMS/1,5-431/MINFS PWR	1443637	279	SAC-5P-MS/5,0-923/FR CAN SCO	1419069	415
SAC-5P-M12MS/5,0-920	1507434	417	SAC-5P-MINMR/5,0-928 DN	1417618	419	SAC-5P-MINMS/1,5-440/MINFS PWR	1443831	276	SAC-5P-MS/5,0-923/FS CAN SCO	1419053	415
SAC-5P-M12MS/5,0-920/M12FS	1507560	417	SAC-5P-MINMR/5,0-928/MINFR DN	1417935	419	SAC-5P-MINMS/1,5-441/MINFS PWR	1419852	277	SAC-5P-MS/10,0-920 SCO	1518193	417
SAC-5P-M12MS/5,0-PUR SH	1682										

Index

Alphabetical

Type	Order No.	Page	Type	Order No.	Page	Type	Order No.	Page	Type	Order No.	Page
SAC-5P-MSB/0,3-900/FSB SCO	1517958	412	SAC-6P-M 8MR/ 3,0-PUR	1522150	191	SAC-8P-M 8MS/ 1,5-PUR/M 8FS SH	1404135	196	SAC-8PY-M/2XF VP SH	1454969	239
SAC-5P-MSB/0,5-900/FSB SCO	1517961	412	SAC-6P-M 8MR/ 3,0-PUR SH	1522354	192	SAC-8P-M 8MS/ 3,0-PUR	1404180	193	SAC-ASI-J-Y-B-FFKDS	1407579	427
SAC-5P-MSB/1,0-900/FSB SCO	1517974	412	SAC-6P-M 8MR/ 5,0-PUR	1522163	191	SAC-8P-M 8MS/ 3,0-PUR SH	1404140	196	SAC-ASI-J-Y-B-M12FS	1405621	428
SAC-5P-MSB/2,0-900 SCO	1517877	412	SAC-6P-M 8MR/ 5,0-PUR SH	1522367	192	SAC-8P-M 8MS/ 3,0-PUR/M 8FR	1404204	193	SAC-ASI-J-Y-B-PUR-1,0-FR SCO	1407577	427
SAC-5P-MSB/2,0-900/FSB SCO	1517987	412	SAC-6P-M 8MR/.....	1522189	191	SAC-8P-M 8MS/ 3,0-PUR/M 8FS	1404200	193	SAC-ASI-J-Y-B-PUR-1,0-FS SCO	1407575	427
SAC-5P-MSB/ 5,0-900 SCO	1517880	412	SAC-6P-M 8MR/10,0-PUR	1522176	191	SAC-8P-M 8MS/ 3,0-PUR/M 8FS SH	1404136	196	SAC-ASI-J-Y-B-PUR-2,0-FR SCO	1407578	427
SAC-5P-MSB/ 5,0-900/FSB SCO	1517990	412	SAC-6P-M 8MR/10,0-PUR SH	1522370	192	SAC-8P-M 8MS/ 5,0-PUR	1404181	193	SAC-ASI-J-Y-B-PUR-2,0-FS SCO	1407576	427
SAC-5P-MSB/10,0-900 SCO	1517893	412	SAC-6P-M 8MS SH/.....	1522338	192	SAC-8P-M 8MS/ 5,0-PUR SH	1404141	196	SAC-ASI-J-Y-B-PUR-2,0-OE	1407581	427
SAC-5P-MSB/10,0-900/FSB SCO	1518009	412	SAC-6P-M 8MS-M 8FR SH/.....	1552023	192	SAC-8P-M 8MS/10,0-PUR	1404179	193	SAC-ASI-J-Y-N-M12FS	1405619	428
SAC-5P-MSB/15,0-900 SCO	1517903	412	SAC-6P-M 8MS-M 8FR/.....	1551930	191	SAC-8P-M 8MS/10,0-PUR SH	1404138	196	SAC-ASI-J-Y-N-PUR-1,0-FS SCO	1407573	427
SAC-5P-MSB/15,0-900/FSB SCO	1518012	412	SAC-6P-M 8MS-M 8FS SH/.....	1552010	192	SAC-8P-M12FR SH/.....	1522956	197	SAC-ASI-J-Y-N-PUR-2,0-FS SCO	1407574	427
SAC-5P-PUR-0,34-SH/...	1408515	283	SAC-6P-M 8MS-M 8FS/.....	1551927	191	SAC-8P-M12FR-PURMC/	1520990	291	SAC-ASI-J-Y-N-PUR-2,0-OE	1407580	427
SAC-5P-PUR-0,34/...	1408509	283	SAC-6P-M 8MS/ 1,5-PUR	1522095	192	SAC-8P-M12FR/.....	1522668	194	SAC-ASI-J-Y-Y-N	1405622	427
SAC-5P-PUR-0,5/...	1408530	284	SAC-6P-M 8MS/ 1,5-PUR SH	1522239	191	SAC-8P-M12FS SH/.....	1522901	197	SAC-M12T/2XM12 CAN	1507793	424
SAC-5P-PVC-0,34-SH/...	1408527	283	SAC-6P-M 8MS/ 3,0-PUR	1522105	191	SAC-8P-M12FS/.....	1522613	194	SAC-M12T/2XM12 PBDD	1458884	424
SAC-5P-PVC-0,34/...	1408523	283	SAC-6P-M 8MS/ 3,0-PUR SH	1522309	192	SAC-8P-M12MR SH/.....	1522859	197	SAC-MR/0,1-116/2XA-1L-Z SCO	1458130	244
SAC-5P-Y/2XFS VP SCO	1546068	239	SAC-6P-M 8MS/ 5,0-PUR	1522118	191	SAC-8P-M12MR-M12FR SH/.....	1552007	197	SAC-MR/0,1-116/2XB-1L-Z SCO	1458318	245
SAC-5P-M-F/2XF SH1 SCO	1417414	424	SAC-6P-M 8MS/ 5,0-PUR SH	1522312	192	SAC-8P-M12MR-M12FR/.....	1551972	194	SAC-MR/0,1-116/2XB-1L-Z SCO	1458499	245
SAC-5PY-F/2X 0,3-920-MS-FS	1436013	420	SAC-6P-M 8MS/.....	1522134	191	SAC-8P-M12MR-M12FS SH/.....	1551998	197	SAC-MR/0,15-116/2XA-1L-Z SCO	1458143	244
SAC-5PY-F/2X 0,5-920-MS-FS	1436026	420	SAC-6P-M 8MS/10,0-PUR	1522121	191	SAC-8P-M12MR-M12FS/.....	1551969	194	SAC-MR/0,15-116/2XB-1L-Z SCO	1458321	245
SAC-5PY-F/2X 1,0-920-MS-FS	1436039	420	SAC-6P-M 8MS/10,0-PUR SH	1522325	192	SAC-8P-M12MR/ 1,5-PUR	1522545	194	SAC-MR/0,15-116/2XB-1L-Z SCO	1458509	245
SAC-5PY-F/2X 2,0-920	1436113	420	SAC-6P-M12FR-PURMC/	1520987	291	SAC-8P-M12MR/ 1,5-PUR SH	1522817	197	SAC-MR/0,15-116/2XB-1L-Z SCO	1458156	244
SAC-5PY-F/2X 2,0-920-MS-FS	1436042	420	SAC-8P- 1,5-PUR/M 8FR	1404191	193	SAC-8P-M12MR/ 1,5-PVC	1415720	195	SAC-MR/0,2-116/2XB-1L-Z SCO	1458334	245
SAC-5PY-F/2X 5,0-920	1436136	420	SAC-8P- 1,5-PUR/M 8FS	1404187	193	SAC-8P-M12MR/ 3,0-PUR	1522558	194	SAC-MR/0,2-116/2XB-1L-Z SCO	1458512	245
SAC-5PY-F/2X 5,0-920-MS-FS	1436055	420	SAC-8P- 1,5-PUR/M 8FS SH	1404147	196	SAC-8P-M12MR/ 3,0-PUR SH	1522820	197	SAC-MS/0,1-116/2XA-1L-Z SCO	1458101	244
SAC-5PY-F/2X10,0-920	1436149	420	SAC-8P- 1,5-PUR/M12FR	1522626	194	SAC-8P-M12MR/ 3,0-PVC	1415721	195	SAC-MS/0,1-116/2XB-1L-Z SCO	1458282	245
SAC-5PY-F/2X10,0-920-MS-FS	1436068	420	SAC-8P- 1,5-PUR/M12FR SH	1522914	197	SAC-8P-M12MR/ 5,0-PUR	1522561	194	SAC-MS/0,1-116/2XB-1L-Z SCO	1458410	245
SAC-5PY-F/2X15,0-920	1436152	420	SAC-8P- 1,5-PUR/M12FS	1522590	194	SAC-8P-M12MR/ 5,0-PUR SH	1522833	197	SAC-MS/0,15-116/2XA-1L-Z SCO	1458164	244
SAC-5PY-F/2X15,0-920-MS-FS	1436071	420	SAC-8P- 1,5-PUR/M12FS SH	1522862	197	SAC-8P-M12MR/ 5,0-PVC	1415722	195	SAC-MS/0,15-116/2XB-1L-Z SCO	1458295	245
SAC-5PY-F/2XM VP SH	1419946	239	SAC-8P- 1,5-PVC/M12FR	1415732	195	SAC-8P-M12MR/.....	1522587	194	SAC-MS/0,15-116/2XB-1L-Z SCO	1458473	245
SAC-5PY-F/M-F VP SH	1419933	239	SAC-8P- 1,5-PVC/M12FS	1415724	195	SAC-8P-M12MR/10,0-PUR	1522574	194	SAC-MS/0,2-116/2XA-1L-Z SCO	1458127	244
SAC-5PY-M/2X 2,0-920	1436084	420	SAC-8P- 3,0-PUR/M 8FR	1404192	193	SAC-8P-M12MR/10,0-PUR SH	1522846	197	SAC-MS/0,2-116/2XB-1L-Z SCO	1458305	245
SAC-5PY-M/2X 5,0-920	1436097	420	SAC-8P- 3,0-PUR/M 8FS	1404188	193	SAC-8P-M12MR/10,0-PVC	1415723	195	SAC-MS/0,2-116/2XB-1L-Z SCO	1458486	245
SAC-5PY-M/2X10,0-920	1436107	420	SAC-8P- 3,0-PUR/M 8FS SH	1404148	196	SAC-8P-M12MS SH/.....	1522804	197	SACB 10-3 L M8 PUR/	1516166	246
SAC-5PY-M/2X15,0-920	1436110	420	SAC-8P- 3,0-PUR/M12FR	1522639	194	SAC-8P-M12MS-M12FR SH/.....	1523052	197	SACB 4- 4 L SCO NPN PUR/	1537019	250
SAC-5PY-M/2XF VP SH	1419920	239	SAC-8P- 3,0-PUR/M12FR SH	1522927	197	SAC-8P-M12MS-M12FR/.....	1522765	194	SACB 4- 4 L SCO PUR/	1516904	250
SAC-5PY-M/F-M VP SH	1438079	239	SAC-8P- 3,0-PUR/M12FS	1522600	194	SAC-8P-M12MS-M12FS SH/.....	1523007	197	SACB 4- 8 L SCO NPN PUR/	1537048	250
SAC-6P- 1,5-PUR/DTFS	1415026	230	SAC-8P- 3,0-PUR/M12FS SH	1522875	197	SAC-8P-M12MS-M12FS/.....	1522710	194	SACB 4- 8 L SCO PUR/	1516917	250
SAC-6P- 1,5-PUR/M 8FR	1522244	191	SAC-8P- 3,0-PVC/M12FR	1415734	195	SAC-8P-M12MS/ 0,3-PUR/M12FR	1522723	194	SACB 4-3 L M8 PUR/	1516137	246
SAC-6P- 1,5-PUR/M 8FR SH	1522448	192	SAC-8P- 3,0-PVC/M12FS	1415725	195	SAC-8P-M12MS/ 0,3-PUR/M12FR SH	1523010	197	SACB 4-3 L M8 PUR/	1548503	252
SAC-6P- 1,5-PUR/M 8FS	1522192	191	SAC-8P- 5,0-PUR/M 8FR	1404193	193	SAC-8P-M12MS/ 0,3-PUR/M12FS	1522671	194	SACB 4-3 QO-0,34 PUR/	1548642	252
SAC-6P- 1,5-PUR/M 8FS SH	1522396	192	SAC-8P- 5,0-PUR/M 8FS SH	1404189	193	SAC-8P-M12MS/ 0,3-PUR/M12FS SH	1522969	197	SACB 4-4 L QO-0,34 PUR/	1548590	252
SAC-6P- 3,0-PUR/DTFS	1415027	230	SAC-8P- 5,0-PUR/M 8FS SH	1404149	196	SAC-8P-M12MS/ 0,3-PVC/M12FR	1415745	195	SACB 4-4 L QO-0,34 PUR/	1548671	252
SAC-6P- 3,0-PUR/M 8FR	1522257	191	SAC-8P- 5,0-PUR/M12FR	1522642	194	SAC-8P-M12MS/ 0,3-PVC/M12FS	1415737	195	SACB 6- 6 L SCO NPN PUR/	1537022	250
SAC-6P- 3,0-PUR/M 8FR SH	1522451	192	SAC-8P- 5,0-PUR/M12FR SH	1522930	197	SAC-8P-M12MS/ 0,6-PUR/M12FR	1522736	194	SACB 6- 6 L SCO PUR/	1516920	250
SAC-6P- 3,0-PUR/M 8FS	1522202	191	SAC-8P- 5,0-PUR/M12FS	1520369	194	SAC-8P-M12MS/ 0,6-PUR/M12FR SH	1523023	197	SACB 6-12 L SCO NPN PUR/	1537051	250
SAC-6P- 3,0-PUR/M 8FS SH	1522406	192	SAC-8P- 5,0-PUR/M12FS SH	1522888	197	SAC-8P-M12MS/ 0,6-PUR/M12FS	1522684	194	SACB 6-12 L SCO PUR/	1516933	250
SAC-6P- 5,0-PUR/DTFS	1415028	230	SAC-8P- 5,0-PUR/M16FR	1693681	291	SAC-8P-M12MS/ 0,6-PUR/M12FS SH	1522972	197	SACB 6-3 L M8 PUR/	1516140	246
SAC-6P- 5,0-PUR/M 8FR	1522260	191	SAC-8P- 5,0-PUR/M12FR SH	1407822	291	SAC-8P-M12MS/ 0,6-PVC/M12FR	1415746	195	SACB 8- 8 L SCO NPN PUR/	1537035	250
SAC-6P- 5,0-PUR/M 8FR SH	1522464	192	SAC-8P- 5,0-PVC/M12FR	1415735	195	SAC-8P-M12MS/ 0,6-PVC/M12FS	1415738	195	SACB 8- 8 L SCO PUR/	1516946	250
SAC-6P- 5,0-PUR/M 8FS	1522215	191	SAC-8P- 5,0-PVC/M12FS	1415726	195	SAC-8P-M12MS/ 1,5-PUR	1522493	194	SACB 8-16 L SCO NPN PUR/	1537064	250
SAC-6P- 5,0-PUR/M 8FS SH	1522419	192	SAC-8P-10,0-PUR/M 8FR	1404194	193	SAC-8P-M12MS/ 1,5-PUR SH	1522778	197	SACB 8-16 L SCO PUR/	1516959	250
SAC-6P- 5,0-PUR/M12FR	1407820	291	SAC-8P-10,0-PUR/M 8FS	1404190	193	SAC-8P-M12MS/ 1,5-PUR/M12FR	1522749	194	SACB 8-3 L M8 PUR/	1516153	246
SAC-6P-10,0-PUR/DTFS	1415029	230	SAC-8P-10,0-PUR/M 8FS SH	1404150	196	SAC-8P-M12MS/ 1,5-PUR/M12FR SH	1523036	197	SACB 8-3 L QO-0,34 PUR/	1548529	252
SAC-6P-10,0-PUR/M 8FR	1522273	191	SAC-8P-10,0-PUR/M12FR	1522655	194	SAC-8P-M12MS/ 1,5-PUR/M12FS	1522697	197	SACB 8-3 L QO-0,34 PUR/	1548668	252
SAC-6P-10,0-PUR/M 8FR SH	1522477	192	SAC-8P-10,0-PUR/M12FR SH	1522943	197	SAC-8P-M12MS/ 1,5-PUR/M12FS SH	1522985	197	SACB 8-4 L M8 PUR/	1516179	246
SAC-6P-10,0-PUR/M 8FS	1522228	191	SAC-8P-10,0-PUR/M12FS	1520372	194	SAC-8P-M12MS/ 1,5-PVC	1415716	195	SACB 8-4 L QO-0,34 PUR/	1548613	252
SAC-6P-10,0-PUR/M 8FS SH	1522422	192	SAC-8P-10,0-PUR/M12FS SH	1522891	197	SAC-8P-M12MS/ 1,5-PVC/M12FR	1415747	195	SACB 8-4 QO-0,34 PUR/	1548697	252
SAC-6P-10,0-PURMC/M12FR	1407821	291	SAC-8P-10,0-PUR/M16FR	1693694	291	SAC-8P-M12MS/ 1,5-PVC/M12FS	1415739	195	SACB 8-4 L L PUR/	1693034	253
SAC-6P-100,0-PUR/0,25	1550614	282	SAC-8P-10,0-PURMC/M12FR	1407823	291	SAC-8P-M12MS/ 3,0-PUR	1522503	194	SACB- 4/3-C QO-0,34	1548354	252
SAC-6P-100,0-PUR/SH-0,14	1550627	283	SAC-8P-10,0-PVC/M12FR	1415736	195	SAC-8P-M12MS/ 3,0-PUR SH	1522781	197	SACB- 4/3-L 5,0PUR QO-0,34	1548448	252
SAC-6P-DTMS/ 0,3-PUR/DTFS	1415035	230	SAC-8P-10,0-PVC/M12FS	1415727	195	SAC-8P-M12MS/ 3,0-PUR/M12FR	1522752	194	SACB- 4/3-L 5,0PUR-M8	1516014	246
SAC-6P-DTMS/ 0,6-PUR/DTFS	1415036	230	SAC-8P-100,0-PUR/0,25	1550630	282	SAC-8P-M12MS/ 3,0-PUR/M12FR SH	1523049	197	SACB- 4/3-L-10,0PUR QO-0,34	1548451	252
SAC-6P-DTMS/ 1,5-PUR	1415030	230	SAC-8P-100,0-PUR/SH-0,25	1550643	283	SAC-8P-M12MS/ 3,0-PUR/M12FS	1522707	194	SACB- 4/3-L-10,0PUR-M8	1516027	246
SAC-6P-DTMS/ 1,5-PUR/DTFS	1415037	230	SAC-8P-100,0-PVC/0,25	1550698	282	SAC-8P-M12MS/ 3,0-PUR/M12FS SH	1522998	197	SACB- 4/3-L-C QO-0,34	1548325	252
SAC-6P-DTMS/ 3,0-PUR	1415031	230	SAC-8P-100,0-PVC/SH-0,25	1550708	283	SAC-8P-M12MS/ 3,0-PVC	1415717	195	SACB- 4/3-L-C M8	1503412	247
SAC-6P-DTMS/ 3,0-PUR/DTFS	1415038	230	SAC-8P-M 8MR/ 1,5-PUR	1404182	193	SAC-8P-M12MS/ 3,0-PVC/M12FR	1415748	195	SACB- 4/3-L-C-M8 GG	1516250	247
SAC-6P-DTMS/ 5,0-PUR											

Alphabetical

Type	Order No.	Page	Type	Order No.	Page	Type	Order No.	Page	Type	Order No.	Page
SACB- 6/3-L-C-M8	1503425	247	SACB-4/ 8-C SCO	1516852	250	SACB-6Q/4P-10,0PUR	1683691	253	SACB-C-H180 8-3 M8 PUR/	1516399	247
SACB- 6/3-L-C-M8 GG	1516263	247	SACB-4/ 8-C SCO P	1452754	249	SACB-6Q/4P-L- 5,0PUR	1695252	253	SACB-C-H180 8/16 SCO	1516713	251
SACB- 6/3-L-M12-M8	1516247	246	SACB-4/ 8-L SCO P PUR/	1401419	248	SACB-6Q/4P-L-10,0PUR	1695265	253	SACB-C-H180 8/4 QO-0,34	1560235	295
SACB- 6/3-L-M16-M8	1516195	247	SACB-4/ 8-L- 5,0HPUR SCO	1517262	250	SACB-6Q/4P-L-SC	1662942	253	SACB-C-H180- 4/3- 5,0PUR-M8	1516292	247
SACB- 6/3-L-SC-M8	1503399	247	SACB-4/ 8-L- 5,0PUR SCO	1517107	250	SACB-6Q/4P-L-SC NPN	1680869	253	SACB-C-H180- 4/3-10,0PUR-M8	1516302	247
SACB- 6/4-C QO-0,34	1548422	252	SACB-4/ 8-L- 5,0PUR SCO P	1452602	248	SACB-6Q/4P-SC	1683646	253	SACB-C-H180- 4/3-M8	1521229	247
SACB- 6/4-L-C QO-0,34	1548396	252	SACB-4/ 8-L- 5,0PUR SCO P NPN	1405713	248	SACB-8/ 3-L- 5,0PUR M5	1530689	255	SACB-C-H180- 6/3- 5,0PUR-M8	1516315	247
SACB- 6X0,34/ 3X0,75-50,0 PUR	1503331	285	SACB-4/ 8-L-10,0HPUR SCO	1517275	250	SACB-8/ 3-L-10,0PUR M5	1530692	255	SACB-C-H180- 6/3-10,0PUR-M8	1516328	247
SACB- 6X0,34/ 2X0,75-50 PUR	1517589	285	SACB-4/ 8-L-10,0PUR SCO	1517110	250	SACB-8/ 3-L-M12 M5	1530773	255	SACB-C-H180- 6/3-M8	1521216	247
SACB- 8/3-C QO-0,34	1548470	252	SACB-4/ 8-L-10,0PUR SCO P	1452615	248	SACB-8/ 4-L- 5,0PUR M5	1530744	255	SACB-C-H180- 8/3- 5,0PUR-M8	1516331	247
SACB- 8/3-L- 5,0PUR QO-0,34	1548480	252	SACB-4/ 8-L-10,0PUR SCO P NPN	1405732	248	SACB-8/ 4-L-10,0PUR M5	1530757	255	SACB-C-H180- 8/3-10,0PUR-M8	1516344	247
SACB- 8/3-L- 5,0PUR-M8	1516056	246	SACB-4/ 8-L-C GG SCO	1516739	251	SACB-8/ 8- 5,0PUR SCO	1517042	250	SACB-C-H180- 8/3-M8	1516425	247
SACB- 8/3-L-10,0PUR QO-0,34	1548493	252	SACB-4/ 8-L-C GG SCO P	1452877	249	SACB-8/ 8- 5,0PUR SCO P	1452518	248	SACB-C-H180-10/3- 5,0PUR-M8	1516357	247
SACB- 8/3-L-10,0PUR-M8	1516069	246	SACB-4/ 8-L-C NPN SCO	1537103	250	SACB-8/ 8-L-10,0PUR SCO	1517055	250	SACB-C-H180-10/3-10,0PUR-M8	1516360	247
SACB- 8/3-L-C QO-0,34	1548341	252	SACB-4/ 8-L-C SCO	1516797	250	SACB-8/ 8-10,0PUR SCO P	1452521	248	SACB-C-H180-10/3-M8	1516412	247
SACB- 8/3-L-C-M8	1511750	247	SACB-4/ 8-L-C SCO P	1452819	249	SACB-8/ 8-C SCO	1516881	250	SACB-C-H180-4/ 4 SCO P PUR/	1401391	249
SACB- 8/3-L-C-M8 GG	1516276	247	SACB-4/ 8-L-PT SCO P	1412058	248	SACB-8/ 8-C SCO P	1452783	249	SACB-C-H180-4/ 4- 5,0PUR SCO	1516353	251
SACB- 8/4-L-M12-M8	1434840	246	SACB-4/ 8-L-SC SCO P	1452990	248	SACB-8/ 8-L-SC SCO P PUR/	1401382	248	SACB-C-H180-4/ 8- 5,0PUR SCO	1453054	249
SACB- 8/3-L-M16-M8	1516205	247	SACB-4/ 8-M23 SH	1695757	254	SACB-8/ 8-L- 5,0PUR SCO	1517165	250	SACB-C-H180-4/ 4-10,0PUR SCO	1516548	251
SACB- 8/3-L-SC-M8	1511747	247	SACB-4/ 8-SC SCO P	1452932	248	SACB-8/ 8-L- 5,0PUR SCO P	1452699	248	SACB-C-H180-4/ 4-10,0PUR SCO P	1453067	249
SACB- 8/4-C QO-0,34	1548435	252	SACB-4/T-L-8FUUSE CT AXL	1413929	281	SACB-8/ 8-L- 5,0PUR SCO P NPN	1405737	248	SACB-C-H180-4/ 8 SCO P PUR/	1401393	249
SACB- 8/4-L- 5,0PUR QO-0,34	1548470	252	SACB-4/T-L-8FUUSE DIAG CT AXL	1411048	281	SACB-8/ 8-L-10,0PUR SCO	1517178	250	SACB-C-H180-6/ 8- 5,0PUR SCO	1516593	251
SACB- 8/4-L- 5,0PUR-M8	1516111	246	SACB-4Q/4P L PUR/	1695249	253	SACB-8/ 8-L-10,0PUR SCO P	1452709	248	SACB-C-H180-4/ 8- 5,0PUR SCO P	1453083	249
SACB- 8/4-L-10,0PUR QO-0,34	1548587	252	SACB-4Q/4P- 5,0PUR	1683662	253	SACB-8/ 8-L-10,0PUR SCO P NPN	1405738	248	SACB-C-H180-4/ 8-10,0PUR SCO	1516603	251
SACB- 8/4-L-10,0PUR-M8	1516124	246	SACB-4Q/4P-10,0PUR	1683675	253	SACB-8/ 8-L-C GG SCO	1516768	251	SACB-C-H180-4/ 8-10,0PUR SCO P	1453096	249
SACB- 8/4-L-C QO-0,34	1548406	252	SACB-4Q/4P-L- 5,0PUR	1695223	253	SACB-8/ 8-L-C GG SCO P	1452903	249	SACB-C-H180-6/ 6 SCO P PUR/	1401411	249
SACB- 8/4-L-C-M8	1503467	247	SACB-4Q/4P-L-10,0PUR	1695236	253	SACB-8/ 8-L-C NPN SCO	1537093	250	SACB-C-H180-6/ 6- 5,0PUR SCO	1516551	251
SACB- 8/4-L-SC-M8	1503454	247	SACB-4Q/4P-L-SC	1662939	253	SACB-8/ 8-L-C SCO	1516823	250	SACB-C-H180-6/ 6- 5,0PUR SCO P	1453119	249
SACB- 8X0,34/ 3X0,75-50,0 PUR	1503344	285	SACB-4Q/4P-L-SC NPN	1680856	253	SACB-8/ 8-L-C SCO P	1452848	249	SACB-C-H180-6/ 6-10,0PUR SCO	1516564	251
SACB- 8X0,34/ 2X0,75-50 PUR	1517592	285	SACB-4Q/4P-SC	1683633	253	SACB-8/ 8-L-PUR SCO OTB 1,5M	1437245	251	SACB-C-H180-6/ 6-10,0PUR SCO P	1453122	249
SACB- 8X0,5/ 3X1,0-50,0 PUR	1503357	285	SACB-6/ 6- 5,0PUR SCO	1517000	250	SACB-8/ 8-L-SC SCO P	1453025	248	SACB-C-H180-6/12 SCO P PUR/	1401413	249
SACB-10/3-L- 5,0PUR-M8	1516072	246	SACB-6/ 6- 5,0PUR SCO P	1452453	248	SACB-8/ 8-SC SCO P	1452961	248	SACB-C-H180-6/12- 5,0PUR SCO	1516616	251
SACB-10/3-L-10,0PUR-M8	1516085	246	SACB-6/ 6-10,0PUR SCO	1517013	250	SACB-8/ 16- 5,0HPUR SCO	1517246	250	SACB-C-H180-6/12- 5,0PUR SCO P	1453148	249
SACB-10/3-L-C-M8	1503438	247	SACB-6/ 6-10,0PUR SCO P	1452466	248	SACB-8/ 16- 5,0PUR SCO	1517068	250	SACB-C-H180-6/12-10,0PUR SCO	1516629	251
SACB-10/3-L-C-M8 GG	1516289	247	SACB-6/ 6-C SCO	1516865	250	SACB-8/ 16- 5,0PUR SCO P	1452547	248	SACB-C-H180-6/12-10,0PUR SCO P	1453151	249
SACB-10/3-L-M12-M8	1434853	246	SACB-6/ 6-C SCO P	1452767	249	SACB-8/ 16- 5,0PUR SH	1695825	254	SACB-C-H180-8/ 8 SCO P PUR/	1401416	249
SACB-10/3-L-M16-M8	1516218	247	SACB-6/ 6-L SCO P PUR/	1401379	248	SACB-8/ 16-10,0HPUR SCO	1517259	250	SACB-C-H180-8/ 8- 5,0PUR SCO	1516577	251
SACB-10/3-L-SC-M8	1503409	247	SACB-6/ 6-L- 5,0PUR SCO	1517123	250	SACB-8/ 16-10,0PUR SCO	1517071	250	SACB-C-H180-8/ 8- 5,0PUR SCO P	1453177	249
SACB-10X0,34/ 2X0,75-50 PUR	1517602	285	SACB-6/ 6-L- 5,0PUR SCO P	1452631	248	SACB-8/ 16-10,0PUR SCO P	1452550	248	SACB-C-H180-8/ 8-10,0PUR SCO	1516580	251
SACB-12X0,5/ 3X1,0-50,0 PUR	1503360	285	SACB-6/ 6-L- 5,0PUR SCO P NPN	1405733	248	SACB-8/ 16-10,0PUR SH	1695838	254	SACB-C-H180-8/ 8-10,0PUR SCO P	1453180	249
SACB-12X0,5/ 3X1,0-50 PUR SH	1401239	285	SACB-6/ 6-L-10,0PUR SCO	1517136	250	SACB-8/ 16-C SCO	1516894	250	SACB-C-H180-8/16 SCO P	1453229	249
SACB-16X0,34/ 2X0,75-50 PUR	1539350	285	SACB-6/ 6-L-10,0PUR SCO P	1452644	248	SACB-8/ 16-C SCO P	1452796	249	SACB-C-H180-8/16 SCO P PUR/	1401418	249
SACB-16X0,5/ 3X1,0-200,0 PUR	1559893	285	SACB-6/ 6-L-10,0PUR SCO P NPN	1405734	248	SACB-8/ 16-C SCO P PUR/	1401383	248	SACB-C-H180-8/16- 5,0PUR SCO	1516632	251
SACB-16X0,5/ 3X1,0-50,0 80MC	1402304	285	SACB-6/ 6-L-C GG SCO	1516742	251	SACB-8/ 16-L- 5,0HPUR SCO	1517301	250	SACB-C-H180-8/16- 5,0PUR SCO P	1453203	249
SACB-16X0,5/ 3X1,0-50,0 PUR	1503373	285	SACB-6/ 6-L-C GG SCO P	1452880	249	SACB-8/ 16-L- 5,0PUR SCO	1517181	250	SACB-C-H180-8/16-10,0PUR SCO	1516645	251
SACB-16X0,5/ 3X1,0-50,0 VPUR	1430938	285	SACB-6/ 6-L-C NPN SCO	1537080	250	SACB-8/ 16-L- 5,0PUR SCO P	1452725	248	SACB-C-H180-8/16-10,0PUR SCO P	1453216	249
SACB-16X0,5/ 3X1,0-50 PUR SH	1539156	285	SACB-6/ 6-L-C SCO	1516807	250	SACB-8/ 16-L- 5,0PUR SCO P NPN	1405739	248	SACB-D PG 13,5 (4,0-6,5) YE	1680377	296
SACB-4/ 3-L- 5,0PUR M5	1530663	255	SACB-6/ 6-L-C SCO P	1452822	249	SACB-8/ 16-L-10,0HPUR SCO	1517314	250	SACB-D PG 13,5 (6,5-9,5) BK	1680380	296
SACB-4/ 3-L-10,0PUR M5	1530676	255	SACB-6/ 6-L-SC SCO P	1453009	248	SACB-8/ 16-L-10,0PUR SCO	1517194	250	SACB-D PG 13,5 (9,0-13,0) RD	1680393	296
SACB-4/ 3-L-M12 M5	1530760	255	SACB-6/ 6-SC SCO P	1452945	248	SACB-8/ 16-L-10,0PUR SCO P	1452738	248	SACC BIT M12-D20	1208445	286
SACB-4/ 4- 5,0PUR SCO	1516926	250	SACB-6/ 12- 5,0HPUR SCO	1517220	250	SACB-8/ 16-L-10,0PUR SCO P NPN	1405740	248	SACC BIT M8-D12	1208474	286
SACB-4/ 4- 5,0PUR SCO P	1452398	248	SACB-6/ 12- 5,0PUR SCO	1517026	250	SACB-8/ 16-L-C GG SCO	1516771	251	SACC-4P-DSI-M12FSD/FSD-M16	1424326	48
SACB-4/ 4-10,0PUR SCO	1516975	250	SACB-6/ 12- 5,0PUR SCO P	1452482	248	SACB-8/ 16-L-C GG SCO P	1452916	249	SACC-5P-DSI-M12MS/FS-M16	1551671	48
SACB-4/ 4-10,0PUR SCO P	1452408	248	SACB-6/ 12- 5,0PUR SH	1695809	254	SACB-8/ 16-L-C NPN SCO	1537129	250	SACC-5P-DSI-M12MSB/FSB-M16	1551684	48
SACB-4/ 4-C SCO	1516849	250	SACB-6/ 12-10,0HPUR SCO	1517233	250	SACB-8/ 16-L-C SCO	1516836	250	SACC-8P-DSI-M12MS/FS-M16	1551697	48
SACB-4/ 4-C SCO P	1452741	249	SACB-6/ 12-10,0PUR SCO	1517039	250	SACB-8/ 16-L-C SCO OTB	1437232	251	SACC-CC-4QO SH ETH	1414415	325
SACB-4/ 4-L SCO P PUR/	1401376	248	SACB-6/ 12-10,0PUR SCO P	1452495	248	SACB-8/ 16-L-C SCO P	1452851	249	SACC-CC-4QO SH PN	1414416	325
SACB-4/ 4-L- 5,0PUR M5	1530702	255	SACB-6/ 12-10,0PUR SH	1695812	254	SACB-8/ 16-L-PT SCO P	1412060	248	SACC-CC-4QO-0,75 SH	1414418	18
SACB-4/ 4-L- 5,0PUR SCO	1517084	250	SACB-6/ 12-C SCO	1516878	250	SACB-8/ 16-L-SC SCO P	1453038	248	SACC-CC-5QO-0,75 SH	1414417	18
SACB-4/ 4-L- 5,0PUR SCO P	1452576	248	SACB-6/ 12-C SCO P	1452770	249	SACB-8/ 16-M23 SH	1695773	254	SACC-CC-8QO SH ETH	1414412	324
SACB-4/ 4-L- 5,0PUR SCO P NPN	1405678	248	SACB-6/ 12-L SCO P PUR/	1401380	248	SACB-8/ 16-SC SCO P	1452974	248	SACC-CC-8QO SH PN	1414413	324
SACB-4/ 4-L-10,0PUR M5	1530715	255	SACB-6/ 12-L- 5,0HPUR SCO	1517288	250	SACB-8/ 8-L-PUR SCO FLK14/MCV3P	1547928	251	SACC-CC-8QO-0,5 SH	1414612	454
SACB-4/ 4-L-10,0PUR SCO	1517097	250	SACB-6/ 12-L- 5,0PUR SCO	1517149	250	SACB-8Q/4P- 5,0PUR	1683701	253	SACC-DSI-FS-12CON-PG9/0,5 SCO	1430446	42
SACB-4/ 4-L-10,0PUR SCO P	1452589	248	SACB-6/ 12-L- 5,0PUR SCO P	1452660	248	SACB-8Q/4P-10,0PUR	1683714	253	SACC-DSI-FS-17CON-PG9/0,5 SCO	1430462	42
SACB-4/ 4-L-10,0PUR SCO P NPN	1405687	248	SACB-6/ 12-L- 5,0PUR SCO P NPN	1405735	248	SACB-8Q/4P-L- 5,0PUR	1695281	253	SACC-DSI-FS-4CON-PG9/0,5 SCO	1556221	42
SACB-4/ 4-L-C GG SCO	1516726	251	SACB-6/ 12-L-10,0HPUR SCO	1517291	250	SACB-8Q/4P-L-10,0PUR	1695294	253	SACC-DSI-FS-5CON-PG 9/0,5 SCO	1542729	42
SACB-4/ 4-L-C GG SCO P	1452864	249	SACB-6/ 12-L-10,0PUR SCO	1517152	250	SACB-8Q/4P-L-SC	1662955	253	SACC-DSI-FS-8CON-PG 9/0,5 SCO	1542732	42
SACB-4/ 4-L-C NPN SCO	1537077	250	SACB-6/ 12-L-10,0PUR SCO P	1452673	248	SACB-8Q/4P-L-SC NPN	1680872				

Index

Alphabetical

Type	Order No.	Page	Type	Order No.	Page	Type	Order No.	Page	Type	Order No.	Page
SACC-DSI-M12FS-4P-M16XL/0,5	1411584	45	SACC-E-M12FS-5CON-PG9/0,5	1671098	33	SACC-FR-5SC M SCO	1432596	19	SACC-M12FR-8Q SH	1553666	325
SACC-DSI-M12FS-5CON-M16/0,5	1419658	44	SACC-E-M12FS-5P-M16XL/0,5	1411571	36	SACC-FR-5SC SH DN SCO	1432790	407	SACC-M12FRD-4Q SH	1553637	325
SACC-DSI-M12FS-8P-M16XL/0,5	1436356	47	SACC-E-M12FS-8CON-M20/0,5	1408453	37	SACC-FR-5SC SH SCO	1432677	19	SACC-M12FRD-4Q SH PN	1554542	325
SACC-DSI-M12FS-5P-M16XL/0,5	1411586	45	SACC-E-M12FS-8CON-PG9/0,5	1513758	33	SACC-FRB-2SC SH PB SCO	1432871	406	SACC-M12FRS-3PECON-PG11-M	1408987	266
SACC-DSI-M12FS-8CON-M16/0,5	1419690	44	SACC-E-M12FS-8P-M16XL/0,5	1411573	36	SACC-FRB-5SC SH IB SCO	1432839	406	SACC-M12FRT-4CON-PG11-M	1408989	266
SACC-DSI-M12FS-8CON-PG9/0,5 P	1436369	47	SACC-E-M12FSB-5P-M16XL/0,5	1411572	36	SACC-FS-12PCON SCO	1559631	17	SACC-M12FS-12SOL-PG 9-M	1404420	17
SACC-DSI-M12FS-8P-M16XL/0,5	1411588	45	SACC-E-M12FSD-4P-M16XL/0,5	1411569	36	SACC-FS-17PCON SCO	1559644	17	SACC-M12FS-12SOL-PG 9-M SH	1404411	17
SACC-DSI-M12FSB-5CON-M16/0,5	1419674	44	SACC-E-M12FSS-3P-M16/0,5 PE	1411654	268	SACC-FS-2QO SH PBPA SCO	1413934	407	SACC-M12FS-4CON-PG 7-SH	1694295	22
SACC-DSI-M12FSB-5P-M16XL/0,5	1411587	45	SACC-E-M12FSS-4CON-M16/0,5 PE	1424137	269	SACC-FS-4CON-PG 7-M SCO	1543029	20	SACC-M12FS-4CON-PG 7-VA	1553242	21
SACC-DSI-M12FSD-4CON-M16/0,5	1419616	44	SACC-E-M12FSS-4P-M16XL/0,5 PE	1411605	270	SACC-FS-4QO-0,34-M SCO	1521588	18	SACC-M12FS-4CON-PG 9-M	1696439	21
SACC-DSI-M12FSD-4P-M16XL/0,5	1411585	45	SACC-E-M12FST-4CON-M16/0,5	1424138	269	SACC-FS-4QO-0,75 SH SCO	1413994	18	SACC-M12FS-4CON-PG 9-SH	1515170	22
SACC-DSI-M12FSS-3P-M16/0,5 PE	1411652	268	SACC-E-M12FST-4P-M16XL/0,5	1411606	270	SACC-FS-4QO-0,75-M SCO	1521601	18	SACC-M12FS-4CON-PG 9-VA	1553268	21
SACC-DSI-M12FSS-4CON-M16/0,5PE	1424133	269	SACC-E-M12MS-12P-M16XL/0,5	1411582	36	SACC-FS-4SC M SCO	1432619	19	SACC-M12FS-4CON-PG11-M PWR	1404416	21
SACC-DSI-M12FSS-4P-M16XL/0,5PE	1411598	270	SACC-E-M12MS-17P-M16XL/0,5	1411576	36	SACC-FS-4SC SH SCO	1432745	19	SACC-M12FS-4CON-PG7	1681114	20
SACC-DSI-M12FST-4CON-M16/0,5	1424134	269	SACC-E-M12MS-4CON-M20/0,5	1408451	37	SACC-FS-5CON-PG 7-M SCO	1543032	20	SACC-M12FS-4CON-PG7-M	1681127	21
SACC-DSI-M12FST-4P-M16XL/0,5	1411599	270	SACC-E-M12MS-4CON-PG9/0,5	1693762	33	SACC-FS-5CON-PG 9-M SCO	1543045	20	SACC-M12FS-4CON-PG7-M SKIN	1430381	21
SACC-DSI-M12MS-12CON-M16/0,5	1419700	44	SACC-E-M12MS-4CON-PG9/0,5 FFVA	1431432	408	SACC-FS-5QO-0,75 SH SCO	1413992	18	SACC-M12FS-4QO-0,34	1641701	18
SACC-DSI-M12MS-4P-M16XL/0,5	1411596	45	SACC-E-M12MS-4P-M16XL/0,5	1411577	36	SACC-FS-5SC M SCO	1432583	19	SACC-M12FS-4QO-0,34-M	1641688	18
SACC-DSI-M12MS-17CON-M16/0,5	1419726	44	SACC-E-M12MS-5CON-M20/0,5	1408446	37	SACC-FS-5SC SH DN SCO	1432787	407	SACC-M12FS-4QO-0,34-VA	1440766	18
SACC-DSI-M12MS-17P-M16XL/0,5	1411597	45	SACC-E-M12MS-5CON-PG9/0,5	1671111	33	SACC-FS-5SC SH SCO	1432664	19	SACC-M12FS-4QO-0,75	1641756	18
SACC-DSI-M12MS-4CON-M16/0,5	1419629	44	SACC-E-M12MS-5P-M16XL/0,5	1411579	36	SACC-FSB-2QO SH PB SCO	1413932	407	SACC-M12FS-4QO-0,75-M	1641772	18
SACC-DSI-M12MS-4P-M16XL/0,5	1411591	45	SACC-E-M12MS-8CON-M20/0,5	1408442	37	SACC-FSB-2SC SH PB SCO	1432868	406	SACC-M12FS-4QO-0,75-VA	1440782	18
SACC-DSI-M12MS-5CON-M16/0,5	1419645	44	SACC-E-M12MS-8CON-PG9/0,5	1513774	33	SACC-FSB-5SC SH IB SCO	1432826	406	SACC-M12FS-4SC SH CCL	1559770	407
SACC-DSI-M12MS-5P-M16XL/0,5	1411593	45	SACC-E-M12MS-8P-M16XL/0,5	1411581	36	SACC-FSD-4QO SH ETH SCO	1411069	325	SACC-M12FS-5CON-DM 3-5 SH VA	1440038	22
SACC-DSI-M12MS-8CON-M16/0,5	1419687	44	SACC-E-M12MSB-5P-M16XL/0,5	1411580	36	SACC-FSD-4QO SH PN SCO	1411071	325	SACC-M12FS-5CON-DM 5-8 SH VA	1440041	22
SACC-DSI-M12MS-8P-M16XL/0,5	1411595	45	SACC-E-M12MSD-4P-M16XL/0,5	1411578	36	SACC-M 8-SET/2,2-3,5	1436945	14	SACC-M12FS-5CON-PG 7	1662298	20
SACC-DSI-M12MSB-5CON-M16/0,5	1419661	44	SACC-E-M12MS-3P-M16/0,5 PE	1411655	268	SACC-M 8FR-3CON-M	1529399	14	SACC-M12FS-5CON-PG 7-M	1662968	21
SACC-DSI-M12MSB-5P-M16XL/0,5	1411594	45	SACC-E-M12MS-4CON-M16/0,5 PE	1424139	269	SACC-M 8FR-3CON-M-SW	1407582	16	SACC-M12FS-5CON-PG 7-VA	1694305	22
SACC-DSI-M12MSD-4CON-M16/0,5	1419603	44	SACC-E-M12MS-4P-M16XL/0,5 PE	1411607	270	SACC-M 8FR-3CON-SH	1436479	14	SACC-M12FS-5CON-PG 7-VA	1553255	21
SACC-DSI-M12MSD-4P-M16XL/0,5	1411592	45	SACC-E-M12MST-4CON-M16/0,5	1424140	269	SACC-M 8FR-4CON-M	1513444	14	SACC-M12FS-5CON-PG 9 SH AU	1508365	22
SACC-DSI-M12MSS-3P-M16/0,5 PE	1411653	268	SACC-E-M12MST-4P-M16XL/0,5	1411608	270	SACC-M 8FR-4CON-M-SW	1407584	16	SACC-M12FS-5CON-PG 9-SH	1694318	22
SACC-DSI-M12MSS-4CON-M16/0,5PE	1424132	269	SACC-E-M5FS-3CON-M5/0,5	1530605	30	SACC-M 8FR-4CON-SH	1436482	14	SACC-M12FS-5CON-PG 9-VA	1553271	21
SACC-DSI-M12MSS-4P-M16XL/0,5PE	1411603	270	SACC-E-M5FS-4CON-M5/0,5	1530618	30	SACC-M 8FS-3CON-M	1681172	14	SACC-M12FS-5CON-PG11-DUO	1694596	23
SACC-DSI-M12MST-4CON-M16/0,5	1424136	269	SACC-E-M5MS-3CON-M5/0,5	1530582	30	SACC-M 8FS-3CON-M-0,34-SH	1542907	16	SACC-M12FS-5CON-PG11-DUO VA	1403372	23
SACC-DSI-M12MST-4P-M16XL/0,5	1411604	270	SACC-E-M5MS-4CON-M5/0,5	1530595	30	SACC-M 8FS-3CON-M-SH	1506927	16	SACC-M12FS-5CON-PG11-M PWR	1404418	21
SACC-DSI-M8FS-3CON-M10/0,5	1456080	32	SACC-E-M8FS-5CON-M10/0,5 DN	1424233	31	SACC-M 8FS-3CON-M-SW	1506888	14	SACC-M12FS-5CON-PG7-M SKIN	1559000	21
SACC-DSI-M8FS-4CON-M10/0,5	1456093	32	SACC-E-M8FS-8CON-M10/0,5	1424231	31	SACC-M 8FS-3QO-0,25-M	1441040	15	SACC-M12FS-5CON-PG9	1500787	20
SACC-DSI-M8FS-6CON-M10/0,5	1456103	32	SACC-E-M8MS-5CON-M10/0,5 DN	1424234	31	SACC-M 8FS-3QO-0,5-M	1441066	15	SACC-M12FS-5CON-PG9-M	1681486	21
SACC-DSI-M8FS-8CON-M10/0,5	1424229	32	SACC-E-M8MS-8CON-M10/0,5	1424232	31	SACC-M 8FS-4CON-M	1681185	14	SACC-M12FS-5CON-PG9-M SKIN	1556838	21
SACC-DSI-M8MS-8CON-M8/0,5	1424230	32	SACC-E-MINFS-3CON-PG13/0,5	1521407	49	SACC-M 8FS-4CON-M-0,34-SH	1542910	16	SACC-M12FS-6Q SH VARAN	1429143	325
SACC-DSI-MINFS-3CON-M26/1,0	1453782	50	SACC-E-MINFS-4CON-PG13/0,5	1521423	49	SACC-M 8FS-4CON-M-SH	1506930	14	SACC-M12FS-8CON-PG 9-SH	1511860	22
SACC-DSI-MINFS-4CON-M26/1,0	1453795	50	SACC-E-MINFS-5CON-PG13/0,5	1521449	49	SACC-M 8FS-4CON-M-SW	1506891	16	SACC-M12FS-8CON-PG11-M	1410665	21
SACC-DSI-MINFS-5CON-M26/1,0	1453805	50	SACC-E-MINMS-3CON-PG13/0,5	1521410	49	SACC-M 8FS-4QO-0,25-M	1441053	15	SACC-M12FS-8CON-PG9-M	1513347	21
SACC-DSI-MINMS-3CON-UNF/1,0	1453753	50	SACC-E-MINMS-4CON-PG13/0,5	1521436	49	SACC-M 8FS-4QO-0,5-M	1441079	15	SACC-M12FS-8Q SH	1553640	325
SACC-DSI-MINMS-4CON-UNF/1,0	1453766	50	SACC-E-MINMS-5CON-PG13/0,5	1521452	49	SACC-M 8MR-3CON-M	1699902	14	SACC-M12FS-8CON-PG 9-SH	1511860	22
SACC-DSI-MINMS-5CON-UNF/1,0	1453799	50	SACC-E-MS-12CON-M16/0,5 SCO	1556265	34	SACC-M 8MR-3CON-M-SW	1407583	16	SACC-M12FS-8CON-PG11-M	1410665	21
SACC-DSI-MS-12CON-M12/0,5 SCO	1437122	43	SACC-E-MS-17CON-M16/0,5 SCO	1556304	34	SACC-M 8MR-3CON-SH	1436453	14	SACC-M12FR-3PECON-PG11-M	1553200	21
SACC-DSI-MS-12CON-PG9/0,5 SCO	1430459	42	SACC-E-MS-4CON-M16/0,5 SCO	1523450	34	SACC-M 8MR-4CON-M	1554209	14	SACC-M12MR-12SOL-PG 9-M	1404421	17
SACC-DSI-MS-17CON-M12/0,5 SCO	1437135	43	SACC-E-MS-5CON-M16/0,5 SCO	1520055	34	SACC-M 8MR-4CON-M-SW	1407585	16	SACC-M12MR-12SOL-PG 9-M SH	1404412	17
SACC-DSI-MS-17CON-PG9/0,5 SCO	1430475	42	SACC-E-MS-8CON-M16/0,5 SCO	1523492	34	SACC-M 8MR-4CON-SH	1436466	14	SACC-M12MR-4CON-PG 7-SH	1694279	22
SACC-DSI-MS-4CON-M12/0,5 SCO	1551875	43	SACC-E-MSB-5CON-M16/0,5 SCO	1520013	34	SACC-M 8MS-3CON-M	1681156	14	SACC-M12MR-4CON-PG 7-VA	1553200	21
SACC-DSI-MS-4CON-PG9/0,5 SCO	1556618	42	SACC-E-MSD-4CON-M16/0,5 SCO	1551558	34	SACC-M 8MS-3CON-M-0,34-SH	1542884	16	SACC-M12MR-4CON-PG 9-VA	1553226	21
SACC-DSI-MS-5CON-M12/0,5 SCO	1551888	43	SACC-E-MU-M 5	1535901	30	SACC-M 8MS-3CON-M-SH	1506901	14	SACC-M12MR-4CON-PG11-M PWR	1408990	21
SACC-DSI-MS-5CON-PG 9/0,5 SCO	1542703	42	SACC-E-MU-M 8	1504071	31	SACC-M 8MS-3CON-M-SW	1501252	16	SACC-M12MR-4CON-PG7	1681091	20
SACC-DSI-MS-8CON-M12/0,5 SCO	1551914	43	SACC-E-MU-M16	1504097	34	SACC-M 8MS-3QO-0,25-M	1441008	15	SACC-M12MR-4CON-PG7-M	1681101	21
SACC-DSI-MS-8CON-PG 9/0,5 SCO	1542716	42	SACC-E-MU-PG13,5	1539143	49	SACC-M 8MS-3QO-0,5-M	1441024	15	SACC-M12MR-5CON-PG 7	1662269	20
SACC-DSI-MSB-5CON-M12/0,5 SCO	1551891	43	SACC-E-MU-PG9	1504084	33	SACC-M 8MS-4CON-M	1681169	14	SACC-M12MR-5CON-PG 7-M	1663129	21
SACC-DSI-MSB-5CON-PG9/0,5 SCO	1543663	43	SACC-EC-FS-4CON-M16/0,5 SCO	1523447	35	SACC-M 8MS-4CON-M-0,34-SH	1542897	16	SACC-M12MR-5CON-PG 7-SH	1693429	22
SACC-DSI-MSD-4CON-M12/0,5 SCO	1551901	43	SACC-EC-FS-5CON-M16/0,5 SCO	1520042	35	SACC-M 8MS-4CON-M-SH	1506914	14	SACC-M12MR-5CON-PG 7-VA	1553213	21
SACC-DSI-MSD-4CON-PG9/0,5 SCO	1551532	42	SACC-EC-FS-8CON-M16/0,5 SCO	1523489	35	SACC-M 8MS-4CON-M-SW	1501265	16	SACC-M12MR-5CON-PG 9-SH	1694282	22
SACC-E-FS-12CON-M16/0,5 SCO	1556252	34	SACC-EC-FSB-5CON-M16/0,5 SCO	1519998	35	SACC-M 8MS-4QO-0,25-M	1441011	15	SACC-M12MR-5CON-PG 9-VA	1553239	21
SACC-E-FS-17CON-M16/0,5 SCO	1556294	34	SACC-EC-FSD-4CON-M16/0,5 SCO	1535215	35	SACC-M 8MS-4QO-0,5-M	1441037	15	SACC-M12MR-5CON-PG11-DUO	1531044	23
SACC-E-FS-4CON-M16/0,5 SCO	1523434	34	SACC-EC-M12FS-4CON-PG9/0,5	1693791	33	SACC-M12-KD-NUT-SH	1440151	54	SACC-M12MR-5CON-PG11-M PWR	1408992	21
SACC-E-FS-5CON-M16/0,5 SCO	1520039	34	SACC-EC-M12FS-5CON-PG9/0,5	1671108	33	SACC-M12-SET/2,5-3,5	1436505	20	SACC-M12MR-5CON-PG9	1513431	20
SACC-E-FS-8CON-M16/0,5 SCO	1523476	34	SACC-EC-M12FS-8CON-PG9/0,5	1513761	33	SACC-M12FR-12SOL-PG 9-M	1404423	17	SACC-M12MR-5CON-PG9-M	1681473	21
SACC-E-FSB-5CON-M16/0,5 SCO	1520000	34	SACC-EC-M12FSB-5CON-PG9/0,5	1515044	33	SACC-M12FR-12SOL-PG 9-M SH	1404413	17	SACC-M12MR-5CON-PG9-M SKINTOP	1561742	21
SACC-E-FSD-4CON-M16/0,5 SCO	1535202	34	SACC-EC-M12MS-4CON-PG9/0,5	1693775	33	SACC-M12FR-4CON-PG 7-VA	1553284	21	SACC-M12MR-6Q SH VARAN	1429156	325
SACC-E-M 8FS-3CON-M8/0,5	1500350	31	SACC-EC-M12MS-5CON-PG9/0,5	1671124	33	SACC-M12FR-4CON-PG11-M PWR	1408991	21	SACC-M12MR-8Q SH	1553653	325
SACC-E-M 8FS-4CON-M8/0,5	1500363	31	SACC-EC-M12MS-8CON-PG9/0,5	1513787	33	SACC-M12FR-4CON-PG7	1681130	20	SACC-M12MRD-4Q SH	1553624	325
SACC-E-M 8FS-6CON-M 8/0,5	1542677	31	SACC-EC-M12MSB-5CON-PG9/0,5	1515057	33	SACC-M12FR-4CON-PG7-M	1681143	21	SACC-M12MRD-4Q		

Type	Order No.	Page	Type	Order No.	Page	Type	Order No.	Page
SACC-M12MS-4CON-PG 9-VA	1553174	21	SACC-MINMS-5CON-PG13/2,5	1456213	24	SACC-VB-3CON-M16/A-1L-SV 230V	1452165	26
SACC-M12MS-4CON-PG11-DUO-M	1507052	23	SACC-MINMS-5CON-PG16	1559039	24	SACC-VB-3CON-M16/A-1L-SV 24V	1452149	26
SACC-M12MS-4CON-PG11-M PWR	1404415	21	SACC-MINMS-5CON-PG16/2,5	1456239	24	SACC-VB-3CON-M16/A-GVL 110V	1452181	27
SACC-M12MS-4CON-PG9-M	1523230	21	SACC-MR-4CON-PG 7-M SCO	1542981	20	SACC-VB-3CON-M16/A-GVL 12/24V	1452178	27
SACC-M12MS-4QO-0,34	1641714	18	SACC-MR-4SC M SCO	1432606	19	SACC-VB-3CON-M16/A-GVL 230V	1452194	27
SACC-M12MS-4QO-0,34-M	1641691	18	SACC-MR-4SC SH SCO	1432732	19	SACC-VB-3CON-M16/B-1L-SV 110V	1452217	28
SACC-M12MS-4QO-0,34-VA	1440753	18	SACC-MR-5CON-PG 7-M SCO	1542994	20	SACC-VB-3CON-M16/B-1L-SV 230V	1452220	28
SACC-M12MS-4QO-0,75	1641769	18	SACC-MR-5CON-PG 9-M SCO	1543003	20	SACC-VB-3CON-M16/B-1L-SV 24V	1452204	28
SACC-M12MS-4QO-0,75-M	1641785	18	SACC-MR-5SC M SCO	1432570	19	SACC-VB-3CON-M16/BI-1L-SV 24V	1452233	28
SACC-M12MS-4QO-0,75-VA	1440779	18	SACC-MR-5SC SH DN SCO	1432774	407	SACC-VB-3CON-M16/BI-1L-SV 110V	1452246	28
SACC-M12MS-4SC SH CCL	1559767	407	SACC-MR-5SC SH SCO	1432651	19	SACC-VB-3CON-M16/BI-1L-SV 230V	1452259	28
SACC-M12MS-5CON-DM 3-5 SH VA	1440012	22	SACC-MRB-2SC SH PB SCO	1432855	406	SACC-VB-4CON-M16/A	1452136	26
SACC-M12MS-5CON-DM 5-8 SH VA	1440025	22	SACC-MRB-5SC SH IB SCO	1432813	406	SACC-VB-5CON-M16/AD-2L 24V	1457908	27
SACC-M12MS-5CON-PG 9	1662256	20	SACC-MS-12PCON SCO	1559592	17	SACCBP-FS-12CON-M16/1,0-PUR SCO	1442188	46
SACC-M12MS-5CON-PG 7-M	1663116	21	SACC-MS-17PCON SCO	1559602	17	SACCBP-FS-12CON-M16/2,0-PVCSCO	1442191	46
SACC-M12MS-5CON-PG 7-SH	1693416	22	SACC-MS-2QO SH PBPA SCO	1413933	407	SACCBP-FS-17CON-M16/1,0-PVCSCO	1442269	46
SACC-M12MS-5CON-PG 7-VA	1553187	21	SACC-MS-4CON-PG 7-M SCO	1542952	20	SACCBP-FS-17CON-M16/2,0-PVCSCO	1442272	46
SACC-M12MS-5CON-PG 9-VA	1500774	20	SACC-MS-4QO-0,34-M SCO	1521755	18	SACCBP-FS-4CON-M16/1,0-PUR SCO	1419302	46
SACC-M12MS-5CON-PG 9 SH AU	1508352	22	SACC-MS-4QO-0,75 SH SCO	1413993	18	SACCBP-FS-4CON-M16/2,0-PUR SCO	1419315	46
SACC-M12MS-5CON-PG 9-M	1681460	21	SACC-MS-4QO-0,75-M SCO	1521591	18	SACCBP-FS-5CON-M16/1,0-PUR SCO	1419328	46
SACC-M12MS-5CON-PG 9-SH	1694266	22	SACC-MS-4SC M SCO	1432635	19	SACCBP-FS-5CON-M16/2,0-PUR SCO	1419331	46
SACC-M12MS-5CON-PG 9-VA	1553190	21	SACC-MS-4SC SH SCO	1432729	19	SACCBP-FS-5CON-M16/2,0-PUR SCO	1437520	411
SACC-M12MS-5CON-PG11-DUO	1662285	23	SACC-MS-5CON-PG 7-M SCO	1542965	20	SACCBP-FS-5CON-PG9/1,0-920SCO	1437533	411
SACC-M12MS-5CON-PG11-DUO VA	1403371	23	SACC-MS-5CON-PG 9-M SCO	1542978	20	SACCBP-FS-5CON-PG9/2,0-920SCO	1437546	411
SACC-M12MS-5CON-PG11-DUO-M	1662748	23	SACC-MS-5CON-PG11-DUO-M SCO	1543016	23	SACCBP-FS-5CON-PG9/5,0-920SCO	1437559	411
SACC-M12MS-5CON-PG11-M PWR	1404417	21	SACC-MS-5QO-0,75 SH SCO	1413991	18	SACCBP-FS-8CON-M16/1,0-PUR SCO	1419357	46
SACC-M12MS-5CON-PG7-M SKIN	1456466	21	SACC-MS-5SC M SCO	1432567	19	SACCBP-FS-8CON-M16/2,0-PUR SCO	1419344	46
SACC-M12MS-5CON-PG9-M SKIN	1556825	21	SACC-MS-5SC SH DN SCO	1432761	407	SACCBP-FSB-2CON-PG9/0,5-910SCO	1437449	410
SACC-M12MS-6Q SH VARAN	1429130	325	SACC-MS-5SC SH SCO	1432648	19	SACCBP-FSB-2CON-PG9/1,0-910SCO	1437452	410
SACC-M12MS-8CON-PG 9-SH	1511857	22	SACC-MSB-2QO SH PB SCO	1413931	407	SACCBP-FSB-2CON-PG9/2,0-910SCO	1437465	410
SACC-M12MS-8CON-PG11-M	1410666	21	SACC-MSB-2SC SH PB SCO	1432842	406	SACCBP-FSB-2CON-PG9/0,5-910SCO	1437478	410
SACC-M12MS-8CON-PG9-M	1513334	21	SACC-MSB-5SC SH IB SCO	1432800	406	SACCBP-FSB-5CON-PG9/0,5-900SCO	1437601	409
SACC-M12MS-8Q SH	1543236	325	SACC-MSD-4QO SH ETH SCO	1411066	325	SACCBP-FSB-5CON-PG9/1,0-900SCO	1437614	409
SACC-M12MSB-5CON-PG9 SH AU	1507764	406	SACC-MSD-4QO SH PN SCO	1411068	325	SACCBP-FSB-5CON-PG9/2,0-900SCO	1437627	409
SACC-M12MST-3PECON-PG11-M	1404641	266	SACC-MSQ-M12MS-25-3,2 SCO	1419959	40	SACCBP-FSB-5CON-PG9/5,0-900SCO	1437630	409
SACC-M12MST-3PECON-PG11-M	1404643	266	SACC-MSQ-P-M12MS-25-2,7 SCO	1424131	267	SACCBP-FSD-4CON-PG9/1,0-933SCO	1437779	383
SACC-M16-KD-NUT-SH	1440164	54	SACC-MSX-8QO SH ETH SCO	1411043	324	SACCBP-FSD-4CON-PG9/2,0-933SCO	1437782	383
SACC-M16-SEAL CLM	1430394	54	SACC-MSX-8QO SH PN SCO	1411044	324	SACCBP-FSD-4CON-PG9/5,0-933SCO	1437795	383
SACC-M16-SEALING PLUG SET	1453368	52	SACC-PG9-KD-NUT-SH	1440177	54	SACCBP-M12FS-5CON-M16/0,5-920	1534465	411
SACC-M16FR-14CON-M	1500253	291	SACC-PG9-SEAL CLM	1556320	54	SACCBP-M12FS-5CON-M16/1,0-920	1534478	411
SACC-M16FS-14CON-M	1500554	291	SACC-SQ-M12FS-12CON-20/0,5	1441710	38	SACCBP-M12FS-5CON-M16/2,0-920	1534481	411
SACC-MCI-M12MS-4CON	1440931	41	SACC-SQ-M12FS-12CON-25F/0,5	1441590	39	SACCBP-M12FS-5CON-M16/5,0-920	1534494	411
SACC-MCI-M12MS-4CON/0,5	1440805	40	SACC-SQ-M12FS-17CON-20/0,5	1441736	38	SACCBP-M12FSB-2CON-M16/0,5-910	1534384	410
SACC-MCI-M12MS-5CON	1419988	41	SACC-SQ-M12FS-17CON-25F/0,5	1441613	39	SACCBP-M12FSB-2CON-M16/1,0-910	1534397	410
SACC-MCI-M12MS-5CON/0,5	1440818	40	SACC-SQ-M12FS-4CON-20/0,5	1419797	38	SACCBP-M12FSB-2CON-M16/2,0-910	1534407	410
SACC-MCI-M12MS-8CON	1440928	41	SACC-SQ-M12FS-4CON-25F/0,5	1420003	39	SACCBP-M12FSB-2CON-M16/5,0-910	1534410	410
SACC-MCI-M12MS-8CON/0,5	1457827	40	SACC-SQ-M12FS-5CON-20/0,5	1441655	38	SACCBP-M12FSB-2CON-M16/0,5-900	1534546	409
SACC-MCI-M12MSB-5CON	1440915	41	SACC-SQ-M12FS-5CON-25F/0,5	1440986	39	SACCBP-M12FSB-5CON-M16/1,0-900	1534559	409
SACC-MCI-M12MSB-5CON/0,5	1440759	40	SACC-SQ-M12FS-8CON-20/0,5	1441697	38	SACCBP-M12FSB-5CON-M16/2,0-900	1534562	409
SACC-MCI-M12MSD-4CON	1440944	41	SACC-SQ-M12FS-8CON-25F/0,5	1441574	39	SACCBP-M12FSB-5CON-M16/5,0-900	1534575	409
SACC-MCI-M12MSD-4CON/0,5	1440821	40	SACC-SQ-M12FSB-5CON-20/0,5	1441671	38	SACCBP-M12MS-5CON-M16/0,5-920	1534423	411
SACC-MCI-MSS-4CON/0,5 PE SCO	1424129	267	SACC-SQ-M12FSB-5CON-25F/0,5	1441558	39	SACCBP-M12MS-5CON-M16/1,0-920	1534436	411
SACC-MCI-MST-4CON/0,5 SCO	1424130	267	SACC-SQ-M12FSD-4CON-20/0,5	1441639	38	SACCBP-M12MS-5CON-M16/2,0-920	1534449	411
SACC-MINFR-3CON-PG 9	1521478	24	SACC-SQ-M12FSD-4CON-25F/0,5	1440960	39	SACCBP-M12MSB-5CON-M16/5,0-910	1534452	411
SACC-MINFR-4CON-PG 9	1521494	24	SACC-SQ-M12MS-12CON-20/0,5	1441707	38	SACCBP-M12MSB-2CON-M16/1,0-910	1534342	410
SACC-MINFR-5CON-PG 9	1521517	24	SACC-SQ-M12MS-12CON-25F/0,5	1441587	39	SACCBP-M12MSB-2CON-M16/1,0-910	1534355	410
SACC-MINFR-5CON-PG11/2,5	1456297	24	SACC-SQ-M12MS-17CON-20/0,5	1441723	38	SACCBP-M12MSB-2CON-M16/2,0-910	1534368	410
SACC-MINFR-5CON-PG13/2,5	1456307	24	SACC-SQ-M12MS-17CON-25F/0,5	1441600	39	SACCBP-M12MSB-2CON-M16/5,0-910	1534371	410
SACC-MINFS-3CON-PG 9	1521300	24	SACC-SQ-M12MS-4CON-20/0,5	1419784	38	SACCBP-M12MSB-5CON-M16/0,5-900	1534504	409
SACC-MINFS-3CON-PG13	1521313	24	SACC-SQ-M12MS-4CON-25F/0,5	1419991	39	SACCBP-M12MSB-5CON-M16/1,0-900	1534517	409
SACC-MINFS-4CON-PG 9	1521342	24	SACC-SQ-M12MS-5CON-20/0,5	1441642	38	SACCBP-M12MSB-5CON-M16/2,0-900	1534520	409
SACC-MINFS-4CON-PG13	1521355	24	SACC-SQ-M12MS-5CON-25F/0,5	1440973	39	SACCBP-M12MSB-5CON-M16/5,0-900	1534533	409
SACC-MINFS-5CON-PG 9	1521384	24	SACC-SQ-M12MS-8CON-20/0,5	1441684	38	SACCBP-MS-12CON-M16/1,0-PVCSCO	1442227	46
SACC-MINFS-5CON-PG11/2,5	1456271	24	SACC-SQ-M12MS-8CON-25F/0,5	1441561	39	SACCBP-MS-12CON-M16/2,0-PVCSCO	1442230	46
SACC-MINFS-5CON-PG13	1521397	24	SACC-SQ-M12MSB-5CON-20/0,5	1441668	38	SACCBP-MS-17CON-M16/1,0-PVCSCO	1442308	46
SACC-MINFS-5CON-PG13/2,5	1456284	24	SACC-SQ-M12MSB-5CON-25F/0,5	1440999	39	SACCBP-MS-17CON-M16/2,0-PVCSCO	1442311	46
SACC-MINFS-5CON-PG16	1559071	24	SACC-SQ-M12MSD-4CON-20/0,5	1441626	38	SACCBP-MS-4CON-M16/1,0-PUR SCO	1419399	46
SACC-MINFS-5CON-PG16/2,5	1456268	24	SACC-SQ-M12MSD-4CON-25F/0,5	1440957	39	SACCBP-MS-4CON-M16/2,0-PUR SCO	1419386	46
SACC-MINMR-3CON-PG 9	1521465	24	SACC-V-3CON-M16/A-1L-S	1544714	27	SACCBP-MS-5CON-M16/1,0-PUR SCO	1419409	46
SACC-MINMR-4CON-PG 9	1521481	24	SACC-V-3CON-PG9/A-1L-S	1671137	27	SACCBP-MS-5CON-M16/2,0-PUR SCO	1419412	46
SACC-MINMR-5CON-PG 9	1521504	24	SACC-V-3CON-PG9/BI-1L-S	1671153	28	SACCBP-MS-5CON-PG9/0,5-920SCO	1437562	411
SACC-MINMR-5CON-PG11/2,5	1456242	24	SACC-V-3CON-PG9/BI-1L-S	1671140	28	SACCBP-MS-5CON-PG9/1,0-920SCO	1437575	411
SACC-MINMR-5CON-PG13/2,5	1456255	24	SACC-VB-3CON-M12/C-1L-SV 24V	1452262	29	SACCBP-MS-5CON-PG9/2,0-920SCO	1437588	411
SACC-MINMS-3CON-PG 9	1521287	24	SACC-VB-3CON-M12/C-1L-SV 110V	1452275	29	SACCBP-MS-5CON-PG9/5,0-920SCO	1437591	411
SACC-MINMS-3CON-PG13	1521290	24	SACC-VB-3CON-M12/C-1L-SV 230V	1452288	29	SACCBP-MS-8CON-M16/1,0-PUR SCO	1419425	46
SACC-MINMS-4CON-PG 9	1521326	24	SACC-VB-3CON-M12/C1-1L-SV 24V	1452291	29	SACCBP-MS-8CON-M16/2,0-PUR SCO	1419438	46
SACC-MINMS-4CON-PG13	1521339	24	SACC-VB-3CON-M12/C1-1L-SV 110V	1452301	29	SACCBP-MSB-2CON-PG9/0,5-910SCO	1437481	410
SACC-MINMS-5CON-PG 9	1521668	24	SACC-VB-3CON-M12/C1-1L-SV 230V	1452314	29	SACCBP-MSB-2CON-PG9/1,0-910SCO	1437494	410
SACC-MINMS-5CON-PG11/2,5	1456226	24	SACC-VB-3CON-M16/A	1452123	26	SACCBP-MSB-2CON-PG9/2,0-910SCO	1437504	410
SACC-MINMS-5CON-PG13	1521371	24	SACC-VB-3CON-M16/A-1L-SV 110V	1452152	26	SACCBP-MSB-2CON-PG9/5,0-910SCO	1437517	410
SACCBP-MSB-5CON-PG9/0,5-900SCO	1437643	409	SACCBP-MSB-5CON-PG9/1,0-900SCO	1437656	409	SACCBP-MSB-5CON-PG9/2,0-900SCO	1437669	409
SACCBP-MSB-5CON-PG9/5,0-900SCO	1437672	409	SACCEC-M12FS-5CON-M16/0,5-920	1525678	411	SACCEC-M12FS-5CON-M16/1,0-920	1525681	411
SACCEC-M12FS-5CON-M16/1,0-920	1525681	411	SACCEC-M12FS-5CON-M16/2,0-920	1525694	411	SACCEC-M12FS-5CON-M16/5,0-920	1525704	411
SACCEC-M12FS-5CON-M16/0,5-910	1525697	410	SACCEC-M12FSB-2CON-M16/0,5-910	1525507	410	SACCEC-M12FSB-2CON-M16/1,0-910	1525507	410
SACCEC-M12FSB-2CON-M16/1,0-910	1525507	410	SACCEC-M12FSB-2CON-M16/2,0-910	1519574	410	SACCEC-M12FSB-2CON-M16/5,0-910	1525610	410
SACCEC-M12FSB-2CON-M16/5,0-910	1525610	410	SACCEC-M12FSB-5CON-M16/0,5-900	1529742	409	SACCEC-M12FSB-5CON-M16/1,0-910	1529755	409
SACCEC-M12FSB-5CON-M16/1,0-910	1529755	409	SACCEC-M12FSB-5CON-M16/2,0-900	1529768	409	SACCEC-M12FSB-5CON-M16/5,0-900	1529771	409
SACCEC-M12MS-5CON-M16/0,5-920	1525623	411	SACCEC-M12MSB-2CON-M16/0,5-910	1525555	410	SACCEC-M12MSB-2CON-M16/1,0-910	1525568	410
SACCEC-M12MS-5CON-M16/1,0-920	1525649	411	SACCEC-M					

Index

Alphabetical

Type	Order No.	Page	Type	Order No.	Page	Type	Order No.	Page	Type	Order No.	Page
SF-5ES1N8A80A2S	1618195	130	SF-Z0026	1607454	159	SH-8ESS48A8LB4S	1621525	104	SM-20KP005	1605736	147
SF-5ES1N8A80A3	1605529	130	SF-Z0027	1607455	161	SH-8ESS48A8LDL	1622002	105	SM-20KP006	1605738	147
SF-5ES1N8A80A3S	1618196	130	SF-Z0028	1607456	161	SH-8ESS48A8LDLS	1621524	104	SM-20KP007	1605739	147
SF-5ES1N8A80DU	1605532	130	SF-Z0029	1607458	158	SH-8ESS48A9LB1S	1621548	106	SM-20KP008	1605741	147
SF-5ES1N8A80DUS	1618197	130	SF-Z0030	1607459	158	SH-8ESS48A9LB2S	1621547	106	SM-36KP001	1605743	147
SF-5ES1N8A8LB1	1605543	130	SF-Z0031	1607461	158	SH-8ESS48A9LB3S	1621546	106	SM-36KP002	1605744	147
SF-5ES1N8A8LB1S	1618198	130	SF-Z0032	1607462	158	SH-8ESS48A9LB4S	1621545	106	SM-36KP003	1605745	147
SF-5ES1N8A8LB2	1605545	130	SF-Z0033	1607463	158	SH-8ESS48A9LDLS	1621544	106	SM-36KP004	1605747	147
SF-5ES1N8A8LB2S	1618199	130	SF-Z0035	1607465	158	SH-8ESS48AAC00S	1621560	108	SM-36KP005	1605749	147
SF-5ES1N8A8LB3	1605546	130	SF-Z0039	1607470	158	SH-8ESS48AAD00S	1621564	108	SM-36KP006	1605750	147
SF-5ES1N8A8LB3S	1618200	130	SF-Z0040	1607471	158	SH-8ESS48AWA00S	1621568	107	SM-36KP007	1605752	147
SF-5ES1N8A8LB4	1605548	130	SF-Z0041	1607472	158	SI-FP-2D1D	1404510	706	SM-36KP008	1605754	147
SF-5ES1N8A8LB4S	1618201	130	SF-Z0042	1613666	159	SI-FP-2R1A-U1A	1404506	706	SM-36KP009	1607057	147
SF-5ES1N8A8LDL	1605549	130	SF-Z0047	1614689	158	SI-FP-D1A	1404501	706	SM-36KS001	1605756	147
SF-5ES1N8A8LDLS	1618202	130	SF-Z0052	1615413	158	SI-FP-D1D-D1E	1404509	706	SM-36KS002	1605758	147
SF-5ES1N8AY000	1607082	133	SF-Z0054	1615585	159	SI-FP-R1A-D1A	1404496	706	SM-36KS003	1605760	147
SF-5ES1N8AYW00	1607405	133	SF-Z0064	1620585	164	SI-FP-R1A-D1A-D1C	1404507	706	SM-36KS004	1605762	147
SF-6AP2000	1605556	99	SF-Z0065	1620586	164	SI-FP-R1A-D1B-D3B	1404502	706	SM-5EP1N8A9L32S	1613425	143
SF-6AS2000	1605557	99	SF-Z0066	1620587	164	SI-FP-R1A-D1B-U1A/0,7	1404504	706	SM-5EP1N8A9L33S	1613426	143
SF-6CP2000	1605559	99	SH-8EPC58A8LB1	1622011	105	SI-FP-R1A-D1E	1404500	706	SM-5EP1N8A9L34S	1613427	143
SF-6CS2000	1605562	99	SH-8EPC58A8LB1S	1621533	104	SI-FP-R1A-R2A-2U1A	1404503	706	SM-5EPWN8AA700	1620663	146
SF-7EE1N8AS000	1605567	135	SH-8EPC58A8LB2	1622010	105	SI-FP-R1A-U1A	1404499	706	SM-5EPWN8AWT00	1613425	143
SF-7EP1N8A90A1	1605568	131	SH-8EPC58A8LB2S	1621532	104	SI-FP-R1A-U1A-D1A	1404497	706	SM-5ES1N8A8L32S	1613428	142
SF-7EP1N8A90A2	1605570	131	SH-8EPC58A8LB3	1622009	105	SI-FP-R1A-U1A-D1B	1404495	706	SM-5ES1N8A8L33S	1613429	142
SF-7EP1N8A90A3	1605571	131	SH-8EPC58A8LB3S	1621531	104	SI-FP-R1A-U1A/0,7	1404512	706	SM-5ES1N8A8L34S	1613430	142
SF-7EP1N8A90DU	1605575	131	SH-8EPC58A8LB4	1622008	105	SI-FP-U1A	1404505	706	SM-5ES1N8A8S22	1613518	142
SF-7EP1N8A9LB1	1605578	131	SH-8EPC58A8LB4S	1621530	104	SI-M1A	1404493	704	SM-5ES1N8A8S23	1613519	142
SF-7EP1N8A9LB2	1605580	131	SH-8EPC58A8LDL	1622007	105	SI-M1A-GL	1407592	704	SM-5ES1N8A8S24	1613520	142
SF-7EP1N8A9LB3	1605581	131	SH-8EPC58A8LDLS	1621529	104	SI-M1A-GT	1407594	704	SM-5ES1N8AY000	1605823	144
SF-7EP1N8A9LB4	1605582	131	SH-8EPC58A9LB1S	1621553	106	SI-M1A-ML	1407588	704	SM-5ES1N8AY000S	1613524	144
SF-7EP1N8A9LDL	1605583	131	SH-8EPC58A9LB2S	1621552	106	SI-M1A-MT	1407590	704	SM-5ES1N8AYW000	1607532	145
SF-7EP1N8AA000	1620660	132	SH-8EPC58A9LB3S	1621551	106	SI-M1A-T	1407586	704	SM-5ES1N8AYW00S	1613525	145
SF-7EP1N8AA600	1620662	132	SH-8EPC58A9LB4S	1621550	106	SI-M1B	1404494	704	SM-7EP1N8A9L32S	1613431	143
SF-7EP1N8AC0A1	1607048	134	SH-8EPC58A9LDLS	1621549	106	SI-M1B-GL	1407593	704	SM-7EP1N8A9L33S	1613432	143
SF-7EP1N8AC0A2	1607049	134	SH-8EPC58AA000S	1621561	108	SI-M1B-GT	1407595	704	SM-7EP1N8A9L34S	1613433	143
SF-7EP1N8AC0A3	1607050	134	SH-8EPC58AAD00S	1621565	108	SI-M1B-MT	1407589	704	SM-7EPWN8AA700	1620664	146
SF-7EP1N8AC0DU	1607051	134	SH-8EPC58AWA00S	1621569	107	SI-M1B-MT	1407591	704	SM-7EPWN8AWT00	1613527	143
SF-7EP1N8ACLB1	1607052	134	SH-8EPS48A8LB1	1622016	105	SI-M1B-T	1407587	704	SM-7ES1N8A8L32S	1613434	142
SF-7EP1N8ACLB2	1607053	134	SH-8EPS48A8LB1S	1621538	104	SI-PP-2R1A	1404520	707	SM-7ES1N8A8L33S	1613435	142
SF-7EP1N8ACLB3	1607054	134	SH-8EPS48A8LB2	1622015	105	SI-PP-2U1A-D2A	1404519	707	SM-7ES1N8A8L34S	1613436	142
SF-7EP1N8ACLB4	1607055	134	SH-8EPS48A8LB2S	1621537	104	SI-PP-R1A	1404517	707	SM-7ES1N8A8S22	1613528	142
SF-7EP1N8ACLDL	1607056	134	SH-8EPS48A8LB3	1622014	105	SI-PP-R1A-R3A	1404521	707	SM-7ES1N8A8S23	1613529	142
SF-7EP1N8AWA00	1605589	132	SH-8EPS48A8LB3S	1621536	104	SI-PP-R1A-S0A	1404516	707	SM-7ES1N8A8S24	1613530	142
SF-7EP1S8AWA00	1620620	132	SH-8EPS48A8LB4	1622013	105	SI-PP-R1A-S0B	1404518	707	SM-7ES1N8AY000	1605865	144
SF-7ES1N8A80A1	1605595	130	SH-8EPS48A8LB4S	1621535	104	SI-PP-U1A	1404522	707	SM-7ES1N8AY000S	1613534	144
SF-7ES1N8A80A1S	1618204	130	SH-8EPS48A8LDL	1622012	105	SI-SES-R1A	1404513	706	SM-7ES1N8AYW000	1607543	145
SF-7ES1N8A80A2	1605596	130	SH-8EPS48A8LDLS	1621534	104	SI-SES-U1A/0,6	1404514	706	SM-7ES1N8AYW00S	1613535	145
SF-7ES1N8A80A2S	1618205	130	SH-8EPS48A9LB1S	1621558	106	SI-SES-U1A/1	1404515	706	SM-Z0001	1605866	166
SF-7ES1N8A80A3	1605597	130	SH-8EPS48A9LB2S	1621557	106	SL-16KP010	1607909	154	SM-Z0003	1607935	162
SF-7ES1N8A80A3S	1618206	130	SH-8EPS48A9LB3S	1621556	106	SL-16KS010	1607956	154	SM-Z0004	1607937	162
SF-7ES1N8A80DU	1605602	130	SH-8EPS48A9LB4S	1621555	106	SL-1CKP010	1607911	154	SM-Z0012	1614349	161
SF-7ES1N8A80DUS	1618207	130	SH-8EPS48A9LDLS	1621554	106	SL-1CKP020	1607912	154	SM-Z0025	1620558	164
SF-7ES1N8A8LB1	1605605	130	SH-8EPS48AAC00S	1621562	108	SL-1CKP030	1607913	154	SM-Z0026	1620559	164
SF-7ES1N8A8LB1S	1618208	130	SH-8EPS48AAD00S	1621566	108	SL-1CKP040	1607914	154	SM-Z0027	1620560	164
SF-7ES1N8A8LB2	1605607	130	SH-8EPS48AWA00S	1621570	107	SL-1CKP050	1607915	154	SM-Z0028	1620627	164
SF-7ES1N8A8LB2S	1618209	130	SH-8ESC58A8LB1	1622001	105	SL-1CKS010	1607916	154	SM-Z0029	1620628	164
SF-7ES1N8A8LB3	1605610	130	SH-8ESC58A8LB1S	1621523	104	SL-1CKS020	1607917	154	SM-Z0030	1620629	164
SF-7ES1N8A8LB3S	1618210	130	SH-8ESC58A8LB2	1622000	105	SL-1CKS030	1607918	154	SS-ZB 17,5 WH	0804963	292
SF-7ES1N8A8LB4	1605614	130	SH-8ESC58A8LB2S	1621522	104	SL-1CKS040	1607919	154	SS-ZB 17,5 WH CUS	0824468	292
SF-7ES1N8A8LB4S	1618211	130	SH-8ESC58A8LB3	1621999	105	SL-1CKS050	1607920	154	SS-ZB 17,5 YE	0804976	292
SF-7ES1N8A8LDL	1605617	130	SH-8ESC58A8LB3S	1621521	104	SL-5EP1N8A9001	1607499	152	SS-ZB 17,5 YE CUS	0824469	292
SF-7ES1N8A8LDLS	1618212	130	SH-8ESC58A8LB4	1621998	105	SL-5EP1N8A9002	1607500	152	SS-ZB WH	5031171	678
SF-7ES1N8AY000	1605622	133	SH-8ESC58A8LB4S	1621520	104	SL-5EPWN8AWA00	1615686	153	ST-08KP010	1607577	73
SF-7ES1N8AYW00	1607429	133	SH-8ESC58A8LDL	1621997	105	SL-5ES1N8A8001	1607501	152	ST-08KP020	1607578	73
SF-7MP2000	1605626	136	SH-8ESC58A8LDLS	1621517	104	SL-5ES1N8A8002	1607503	152	ST-08KP030	1607579	73
SF-7MS2000	1605628	136	SH-8ESC58A9LB1S	1621543	106	SL-7EP1N8A9001	1607505	152	ST-08KS010	1607580	73
SF-7NS2000	1605631	136	SH-8ESC58A9LB2S	1621542	106	SL-7EP1N8A9002	1607506	152	ST-08KS020	1607581	73
SF-7PP2000	1605634	136	SH-8ESC58A9LB3S	1621541	106	SL-7EPWN8AWA00	1615687	153	ST-08KS030	1607582	73
SF-7PS2000	1605636	136	SH-8ESC58A9LB4S	1621540	106	SL-7ES1N8A8001	1607507	152	ST-08P1N8A6100S	1618584	71
SF-7QP2000	1605639	136	SH-8ESC58A9LDLS	1621539	106	SL-7ES1N8A8002	1607508	152	ST-08P1N8A8003	1618995	67
SF-7QS2000	1605643	136	SH-8ESC58AAC00S	1621559	108	SL-Z0005	1607926	166	ST-08P1N8A8003S	1618999	66
SF-7RP2000	1605646	136	SH-8ESC58AAD00S	1621563	108	SL-Z0007	1613484	160	ST-08P1N8A8004	1618996	67
SF-BIT-HEX 3-50	1212647	669	SH-8ESC58AWA00S	1621567	107	SL-Z0008	1613485	160	ST-08P1N8A8004S	1619000	66
SF-M BH	1212070	669	SH-8ESS48A8LB1	1622006	105	SL-Z0010	1613487	160	ST-08P1N8A8005	1618997	67
SF-Z0003	1605657	159	SH-8ESS48A8LB1S	1621528	104	SL-Z0011	1613488	160	ST-08P1N8A8005S	1619001	66
SF-Z0011	1605675	159	SH-8ESS48A8LB2	1622005	105	SL-Z0012	1613489	160	ST-08P1N8A8K02S	1618641	62
SF-Z0013	1605681	159	SH-8ESS48A8LB2S	1621527	104	SL-Z0013	1613490	160	ST-08P1N8A8K03S	1618648	62
SF-Z0014	1607446</										

Type	Order No.	Page	Type	Order No.	Page	Type	Order No.	Page	Type	Order No.	Page
ST-08P1N8A9005S	1619013	68	ST-17S1N8A8K03S	1613324	62	ST-5EP1N8A8005S	1624541	118	ST-6ES1N8A8K04S	1618630	114
ST-08P1N8A9K02S	1617799	63	ST-17S1N8A8K04S	1613325	62	ST-5EP1N8A8K02S	1618614	114	ST-6ES1N8A9003S	1613583	120
ST-08P1N8A9K03S	1617813	63	ST-17S1N8A9003S	1607647	68	ST-5EP1N8A8K03S	1618615	114	ST-6ES1N8A9004S	1613584	120
ST-08P1N8A9K04S	1617830	63	ST-17S1N8A9004S	1607649	68	ST-5EP1N8A8K04S	1618616	114	ST-6ES1N8A9005S	1624551	120
ST-08P1N8AA400S	1620439	70	ST-17S1N8A9005S	1624533	68	ST-5EP1N8A9003S	1607706	120	ST-6ES1N8A9K02S	1618708	115
ST-08P1N8AA500S	1620456	70	ST-17S1N8A9K02S	1618756	63	ST-5EP1N8A9004S	1607707	120	ST-6ES1N8A9K03S	1618709	115
ST-08P1N8ACK02S	1617925	64	ST-17S1N8A9K03S	1618757	63	ST-5EP1N8A9005S	1624542	120	ST-6ES1N8A9K04S	1618710	115
ST-08P1N8ACK03S	1617929	64	ST-17S1N8A9K04S	1618758	63	ST-5EP1N8A9K02S	1618703	115	ST-6ES1N8AA400S	1620434	122
ST-08P1N8ACK04S	1617932	64	ST-17S1N8AA400S	1620442	70	ST-5EP1N8A9K03S	1618702	115	ST-6ES1N8AA500S	1620449	122
ST-08P1N8AH100S	1619034	71	ST-17S1N8AA500S	1620457	70	ST-5EP1N8A9K04S	1618701	115	ST-6ES1N8ACK02S	1618780	116
ST-08P1N8AW400S	1619037	65	ST-17S1N8ACK02S	1618834	64	ST-5EP1N8AA400S	1620431	122	ST-6ES1N8ACK03S	1618781	116
ST-08P1N8AW500S	1619219	69	ST-17S1N8ACK03S	1618835	64	ST-5EP1N8AA500S	1620448	122	ST-6ES1N8ACK04S	1618782	116
ST-08P1N8AWK00S	1619196	69	ST-17S1N8ACK04S	1618836	64	ST-5EP1N8ACK02S	1618767	116	ST-6ES1N8AH100S	1613587	123
ST-08P1N8AWQ00S	1613286	65	ST-17S1N8AH100S	1613543	71	ST-5EP1N8ACK03S	1618768	116	ST-6ES1N8AAW400S	1613588	117
ST-08S1N8A6100S	1619036	71	ST-17S1N8AW400S	1607653	65	ST-5EP1N8ACK04S	1618769	116	ST-6ES1N8AW500S	1619216	121
ST-08S1N8A8003	1619003	67	ST-17S1N8AW500S	1619226	69	ST-5EP1N8AH100S	1613549	123	ST-6ES1N8AAWK00S	1619193	121
ST-08S1N8A8003S	1619007	66	ST-17S1N8AWK00S	1619206	69	ST-5EP1N8AW400S	1607710	117	ST-6ES1N8AWQ00S	1613589	117
ST-08S1N8A8004S	1619004	67	ST-17S1N8AWQ00S	1607654	65	ST-5EP1N8AW500S	1619213	121	ST-7EP1N8A6100S	1613590	123
ST-08S1N8A8004S	1619008	66	ST-20KP010	1607655	125	ST-5EP1N8AWK00S	1619190	121	ST-7EP1N8A8003	1607735	119
ST-08S1N8A8005S	1619005	67	ST-20KP020	1607656	125	ST-5EP1N8AWQ00S	1607711	117	ST-7EP1N8A8003S	1607736	118
ST-08S1N8A8005S	1619009	66	ST-20KS010	1607657	125	ST-5ES1N8A6100S	1613550	123	ST-7EP1N8A8004	1607737	119
ST-08S1N8A8K02S	1613370	62	ST-20KS020	1607658	125	ST-5ES1N8A8003	1607717	119	ST-7EP1N8A8004S	1607738	118
ST-08S1N8A8K03S	1613371	62	ST-3EP1N8A6100S	1613544	123	ST-5ES1N8A8003S	1607718	118	ST-7EP1N8A8005S	1624552	119
ST-08S1N8A8K04S	1613372	62	ST-3EP1N8A8003	1607663	119	ST-5ES1N8A8004	1607719	119	ST-7EP1N8A8005S	1624553	118
ST-08S1N8A9003S	1619015	68	ST-3EP1N8A8003S	1607665	118	ST-5ES1N8A8004S	1607720	118	ST-7EP1N8A8K02S	1618640	114
ST-08S1N8A9004S	1619016	68	ST-3EP1N8A8004	1607666	119	ST-5ES1N8A8005S	1624544	118	ST-7EP1N8A8K03S	1618639	114
ST-08S1N8A9005S	1619017	68	ST-3EP1N8A8004S	1607667	118	ST-5ES1N8A8K02S	1618621	114	ST-7EP1N8A8K04S	1618638	114
ST-08S1N8A9K02S	1618724	63	ST-3EP1N8A8005S	1624534	119	ST-5ES1N8A8K03S	1618620	114	ST-7EP1N8A9003S	1607741	120
ST-08S1N8A9K03S	1618725	63	ST-3EP1N8A8005S	1624535	118	ST-5ES1N8A8K04S	1618619	114	ST-7EP1N8A9004S	1607742	120
ST-08S1N8A9K04S	1618726	63	ST-3EP1N8A8K02S	1618602	114	ST-5ES1N8A9003S	1607723	120	ST-7EP1N8A9005S	1624554	120
ST-08S1N8AA400S	1620440	70	ST-3EP1N8A8K03S	1618574	114	ST-5ES1N8A9004S	1607724	120	ST-7EP1N8A9K02S	1618712	115
ST-08S1N8AA500S	1620455	70	ST-3EP1N8A8K04S	1618575	114	ST-5ES1N8A9005S	1624545	120	ST-7EP1N8A9K03S	1618713	115
ST-08S1N8ACK02S	1618801	64	ST-3EP1N8A9003S	1607670	120	ST-5ES1N8A9K02S	1618696	115	ST-7EP1N8A9K04S	1618714	115
ST-08S1N8ACK03S	1618802	64	ST-3EP1N8A9004S	1607671	120	ST-5ES1N8A9K03S	1618697	115	ST-7EP1N8AA400S	1620435	122
ST-08S1N8ACK04S	1618805	64	ST-3EP1N8A9005S	1624536	120	ST-5ES1N8A9K04S	1618698	115	ST-7EP1N8AA500S	1620452	122
ST-08S1N8AH100S	1619035	71	ST-3EP1N8A9K02S	1620614	115	ST-5ES1N8AA400S	1620432	122	ST-7EP1N8ACK02S	1618788	116
ST-08S1N8AW400S	1619038	65	ST-3EP1N8A9K03S	1618406	115	ST-5ES1N8AA500S	1620447	122	ST-7EP1N8ACK03S	1618790	116
ST-08S1N8AW500S	1619220	69	ST-3EP1N8A9K04S	1618690	115	ST-5ES1N8ACK02S	1618772	116	ST-7EP1N8ACK04S	1618791	116
ST-08S1N8AWK00S	1619197	69	ST-3EP1N8AA400S	1620427	122	ST-5ES1N8ACK03S	1618773	116	ST-7EP1N8AH100S	1613591	123
ST-08S1N8AWQ00S	1619039	65	ST-3EP1N8AA500S	1620444	122	ST-5ES1N8ACK04S	1618774	116	ST-7EP1N8AAW400S	1607746	117
ST-10KP010	1618255	73	ST-3EP1N8ACK02S	1618402	116	ST-5ES1N8AH100S	1613551	123	ST-7EP1N8AW500S	1619217	121
ST-10KP020	1618256	73	ST-3EP1N8ACK03S	1618407	116	ST-5ES1N8AW400S	1607727	117	ST-7EP1N8AWK00S	1619194	121
ST-10KP030	1618261	73	ST-3EP1N8ACK04S	1618760	116	ST-5ES1N8AW500S	1619214	121	ST-7EP1N8AWQ00S	1607747	117
ST-10KS010	1618239	73	ST-3EP1N8AH100S	1613545	123	ST-5ES1N8AWK00S	1619191	121	ST-7ES1N8A6100S	1613592	123
ST-10KS020	1618251	73	ST-3EP1N8AW400S	1607674	117	ST-5ES1N8AWQ00S	1607728	117	ST-7ES1N8A8003	1607755	119
ST-10KS030	1618254	73	ST-3EP1N8AW500S	1619209	121	ST-6EP1N8A6100S	1613553	123	ST-7ES1N8A8003S	1607756	118
ST-17P1N8A6100S	1613540	71	ST-3EP1N8AWK00S	1619186	121	ST-6EP1N8A8003	1613558	119	ST-7ES1N8A8004	1607758	119
ST-17P1N8A8003	1607624	67	ST-3EP1N8AWQ00S	1607675	117	ST-6EP1N8A8003S	1613559	118	ST-7ES1N8A8004S	1607759	118
ST-17P1N8A8003S	1607625	66	ST-3ES1N8A6100S	1613546	123	ST-6EP1N8A8004	1613560	119	ST-7ES1N8A8005	1624555	119
ST-17P1N8A8004	1607626	67	ST-3ES1N8A8003	1607682	119	ST-6EP1N8A8004S	1613561	118	ST-7ES1N8A8005S	1624556	118
ST-17P1N8A8004S	1607627	66	ST-3ES1N8A8003S	1607683	118	ST-6EP1N8A8005	1624546	119	ST-7ES1N8A8K02S	1618633	114
ST-17P1N8A8005	1624528	67	ST-3ES1N8A8004	1607684	119	ST-6EP1N8A8005S	1624547	118	ST-7ES1N8A8K03S	1618634	114
ST-17P1N8A8005S	1624529	66	ST-3ES1N8A8004S	1607685	118	ST-6EP1N8A8K02S	1618622	114	ST-7ES1N8A8K04S	1618635	114
ST-17P1N8A8K02S	1618682	62	ST-3ES1N8A8005	1624537	119	ST-6EP1N8A8K03S	1618623	114	ST-7ES1N8A9003S	1607764	120
ST-17P1N8A8K03S	1618683	62	ST-3ES1N8A8005S	1624538	118	ST-6EP1N8A8K04S	1618624	114	ST-7ES1N8A9004S	1607765	120
ST-17P1N8A8K04S	1618684	62	ST-3ES1N8A8K02S	1618312	114	ST-6EP1N8A9003S	1613564	120	ST-7ES1N8A9005S	1624557	120
ST-17P1N8A9003S	1607630	68	ST-3ES1N8A8K03S	1618408	114	ST-6EP1N8A9004S	1613565	120	ST-7ES1N8A9K02S	1618716	115
ST-17P1N8A9004S	1607631	68	ST-3ES1N8A8K04S	1618603	114	ST-6EP1N8A9005S	1624548	120	ST-7ES1N8A9K03S	1618717	115
ST-17P1N8A9005S	1624530	68	ST-3ES1N8A9003S	1607688	120	ST-6EP1N8A9K02S	1618704	115	ST-7ES1N8A9K04S	1618718	115
ST-17P1N8A9K02S	1613497	63	ST-3ES1N8A9004S	1607689	120	ST-6EP1N8A9K03S	1618705	115	ST-7ES1N8AA400S	1620436	122
ST-17P1N8A9K03S	1613896	63	ST-3ES1N8A9005S	1624539	120	ST-6EP1N8A9K04S	1618706	115	ST-7ES1N8AA500S	1620451	122
ST-17P1N8A9K04S	1614532	63	ST-3ES1N8A9K02S	1618695	115	ST-6EP1N8AA400S	1620433	122	ST-7ES1N8ACK02S	1618787	116
ST-17P1N8AA400S	1620441	70	ST-3ES1N8A9K03S	1618694	115	ST-6EP1N8AA500S	1620450	122	ST-7ES1N8ACK03S	1618786	116
ST-17P1N8AA500S	1620458	70	ST-3ES1N8A9K04S	1618693	115	ST-6EP1N8ACK02S	1618776	116	ST-7ES1N8ACK04S	1618785	116
ST-17P1N8ACK02S	1617863	64	ST-3ES1N8AA400S	1620428	122	ST-6EP1N8ACK03S	1618777	116	ST-7ES1N8AH100S	1613593	123
ST-17P1N8ACK03S	1617872	64	ST-3ES1N8AA500S	1620443	122	ST-6EP1N8ACK04S	1618778	116	ST-7ES1N8AAW400S	1607768	117
ST-17P1N8ACK04S	1617873	64	ST-3ES1N8ACK02S	1618762	116	ST-6EP1N8AH100S	1613568	123	ST-7ES1N8AW500S	1619218	121
ST-17P1N8AH100S	1613541	71	ST-3ES1N8ACK03S	1618763	116	ST-6EP1N8AAW400S	1613569	117	ST-7ES1N8AAWK00S	1619195	121
ST-17P1N8AW400S	1607634	65	ST-3ES1N8ACK04S	1618764	116	ST-6EP1N8AW500S	1619215	121	ST-7ES1N8AWQ00S	1607769	117
ST-17P1N8AW500S	1619225	69	ST-3ES1N8AH100S	1613547	123	ST-6EP1N8AWK00S	1619192	121	ST-8EP1N8A6100S	1613600	119
ST-17P1N8AWK00S	1619202	69	ST-3ES1N8AW400S	1607692	117	ST-6EP1N8AWQ00S	1613570	117	ST-8EP1N8A8003	1613601	119
ST-17P1N8AWQ00S	1607636	65	ST-3ES1N8AW500S	1619212	121	ST-6ES1N8A6100S	1613572	123	ST-8EP1N8A8003S	1613601	118
ST-17S1N8A6100S	1613542	71	ST-3ES1N8AWK00S	1619189	121	ST-6ES1N8A8003	1613577	119	ST-8EP1N8A8004	1613602	119
ST-17S1N8A8003	1607641	67	ST-3ES1N8AWQ00S	1607694	117	ST-6ES1N8A8003S	1613578	118	ST-8EP1N8A8004S	1613603	118
ST-17S1N8A8003S	1607642	66	ST-5EP1N8A6100S	1613548	123	ST-6ES1N8A8004	1613579	119	ST-8EP1N8A8005	1624636	119
ST-17S1N8A8004	1607643	67	ST-5EP1N8A8003	1607699	119	ST-6ES1N8A8004S	1613580	118	ST-8EP1N8A8005S	1624637	118
ST-17S1N8A8004S	1607644	66	ST-5EP1N8A8003S	1607700	118	ST-6ES1N8A8005	1624549	118	ST-8EP1N8A8K02S	1618681	114
ST-17S1N8A8005	1624531	67	ST-5EP1N8A8004	1607701	119	ST-6ES1N8A8005S	1624550	118	ST-8EP1N8A8K03S	1618680	114
ST-17S1N8A8005S	1624532	66	ST-5EP1N8A8004S	1607702	118	ST-6ES1N8A8K02S	1618632	114	ST-8EP1N8A8K04S	1618679	114
ST-17S1N8A8K02S</											

Index

Alphabetical

Type	Order No.	Page	Type	Order No.	Page	Type	Order No.	Page	Type	Order No.	Page
ST-8EP1N8A9004S	1613607	120				VS-09-SET-EMV	1689158	432	VS-MP-PPC/CG-PO/10G	1403682	347
ST-8EP1N8A9005S	1624653	120				VS-09-ST-DSUB/10-MPT-0,5	1688379	433	VS-MP-PPC/CG-PO/FO	1404321	357
ST-8EP1N8A9K02S	1618740	115				VS-93A/...	1416486	380	VS-MP-PPC/PPC-1G	1403685	348
ST-8EP1N8A9K03S	1618741	115				VS-94A/...	1416415	381	VS-MP-PPC/PPC-PO	1403684	348
ST-8EP1N8A9K04S	1618742	115				VS-94D/...	1416444	381	VS-MSTBAH 2,5/ 5-GB-5,08-BK-A	1657915	350
ST-8EP1N8AA400S	1620437	122	UC-TMF 5	0818153	361	VS-94E/...	1416460	381	VS-MSTBAH 2,5/ 5-GB-5,08-RD-B	1609549	350
ST-8EP1N8AA500S	1620454	122	UC-TMF 16 YE	0819259	294	VS-A-F-IP67	1653744	337	VS-MSTBVA 2,5/ 5-GB-5,08-BK-A	1609565	350
ST-8EP1N8ACK02S	1618818	116	UCT-EM (7X10)	0830765	281	VS-A-F-IP67-BK	1658668	337	VS-MSTBVA 2,5/ 5-GB-5,08-RD-B	1609581	350
			USA 10/4,6	1202713	468						
ST-8EP1N8ACK03S	1618819	116				VS-ASI-FC-EPDM-BK 1000M	1434659	426	VS-OE-OE-937/...	1402687	380
ST-8EP1N8ACK04S	1618820	116				VS-ASI-FC-EPDM-BK 100M	1432415	426	VS-OE-OE-93A-100,0	1416392	380
ST-8EP1N8AH100S	1613610	123				VS-ASI-FC-EPDM-YE 1000M	1434646	426	VS-OE-OE-93B-100,0	1416389	380
ST-8EP1N8AW400S	1613611	117				VS-ASI-FC-EPDM-YE 100M	1432402	426	VS-OE-OE-93B/...	1417362	380
ST-8EP1N8AW500S	1620462	121				VS-ASI-FC-PUR-BK 1000M	1404896	426	VS-OE-OE-93C-100,0	1416376	380
ST-8EP1N8AWK00S	1620460	121	VC-EW 1,6	1884869	635	VS-ASI-FC-PUR-BK 100M	1404854	426	VS-OE-OE-93C/...	1417491	380
ST-8EP1N8AWQ00S	1613612	117	VC-K-KV-PG16(9-13)	1853764	632	VS-ASI-FC-PUR-YE 100M	1404883	426	VS-OE-OE-93E-100,0	1416295	381
ST-8ES1N8A6100S	1613614	123	VC-K-KV-PG16(11,5-15,5)	1854844	632	VS-ASI-FC-PUR-YE/1000	1404841	426	VS-OE-OE-93E/...	1417320	381
			VC-TR-S	1607826	659						
ST-8ES1N8A8003	1613619	119				VS-ASI-FC-PVC-UL-BK 100M	1404919	426	VS-OE-OE-93R-100,0	1416363	380
ST-8ES1N8A8003S	1613620	118	VS-04-2X2X26C7/7-67A/67B/2,0	1653870	438	VS-ASI-FC-PVC-UL-BK/1000	1404870	426	VS-OE-OE-93R/...	1416388	380
ST-8ES1N8A8004	1613621	119	VS-04-2X2X26C7/7-67A/67B/5,0	1655742	438	VS-ASI-FC-PVC-UL-YE 100M	1404906	426	VS-OE-OE-94A-100,0	1416305	381
ST-8ES1N8A8004S	1613622	119	VS-04-2X2X26C7/7-67A/OE/2,0	1655755	438	VS-ASI-FC-PVC-UL-YE/1000	1404867	426	VS-OE-OE-94B-100,0	1416567	381
ST-8ES1N8A8005	1624638	119	VS-04-2X2X26C7/7-67A/OE/5,0	1655768	438	VS-ASI-FC-TPE-UL-BK 1000M	1434675	426	VS-OE-OE-94B/...	1417333	381
ST-8ES1N8A8005S	1624639	118	VS-04-2X2X26C7/7-67A/SDB/2,0	1653896	438	VS-ASI-FC-TPE-UL-BK 100M	1404935	426	VS-OE-OE-94C-100,0	1416318	381
ST-8ES1N8A8K02S	1618674	114	VS-04-2X2X26C7/7-67A/SDB/5,0	1653906	438	VS-ASI-FC-TPE-UL-YE 1000M	1434662	426	VS-OE-OE-94C/...	1417346	381
ST-8ES1N8A8K03S	1618675	114	VS-04-2X2X26C7/7-67B/SDA/2,0	1653919	438	VS-ASI-FC-TPE-UL-YE 100M	1404922	426	VS-OE-OE-94D-100,0	1416334	381
ST-8ES1N8A8K04S	1618676	114	VS-04-2X2X26C7/7-67B/SDA/5,0	1653922	438	VS-ASI-J-Y-N-M12FS-LC	1433155	428	VS-OE-OE-94E-100,0	1416350	381
ST-8ES1N8A9003S	1613625	120	VS-04-2X2X26C7/7-SDA/OE/1,0	1655771	438	VS-ASI-J-Y-N-SWA-LC	1433168	428	VS-OE-OE-94F-100,0	1416347	381
ST-8ES1N8A9004S	1613626	120	VS-04-2X2X26C7/7-SDA/OE/2,0	1655784	438	VS-BH-M12FS-8CON-RJ45/ 90	1405057	327	VS-OE-OE-94F/...	1417359	381
ST-8ES1N8A9005S	1624654	120	VS-04-2X2X26C7/7-SDA/OE/5,0	1655797	438	VS-BH-M12FS-8CON-RJ45/180	1405060	327	VS-OE-PPC/ME-93B-LI/5,0	1416162	382
ST-8ES1N8A9K02S	1618748	115	VS-04-2X2X26C7/7-SDA/SDB/1,0	1654853	438	VS-BH-M12FSD-RJ45/180	1657494	327	VS-OE-PPC/PL-93B-LI/5,0	1416168	383
ST-8ES1N8A9K03S	1618749	115	VS-04-2X2X26C7/7-SDA/SDB/2,0	1653935	438	VS-BH-M12FSD-RJ45/90	1657261	327	VS-P1220-P1220-C1020/ 1,0	1609170	352
ST-8ES1N8A9K04S	1618750	115	VS-04-2X2X26C7/7-SDA/SDB/5,0	1653948	438	VS-BH-M12FSX-10G-RJ45/180	1404549	327	VS-P1220-P1220-C1020/ 2,0	1609183	352
ST-8ES1N8AA400S	1620438	122	VS-04-BUA-FK-F/IP67	1653854	439	VS-BH-M12FSX-10G-RJ45/90	1404548	327	VS-P1220-P1220-C1020/ 5,0	1609196	352
ST-8ES1N8AA500S	1620453	122	VS-04-BUB-FK-F/IP67	1653867	439	VS-BU-CD-1,0/14,4/0,2	1688997	434	VS-P1220-P1220-C1020/...	1609206	352
ST-8ES1N8ACK02S	1618825	116	VS-04-C-SDA/PH/0,3	1405552	439	VS-BU-CD-1,0/14,4/0,5	1688984	434	VS-P1220-P1226-C1021/ 1,0	1609219	353
ST-8ES1N8ACK03S	1618824	116	VS-04-C-SDA/SDB/1,8	1405578	439	VS-BU-CD-HD-1,0/13,5/0,37	1655263	434	VS-P1220-P1226-C1021/ 2,0	1609222	353
ST-8ES1N8ACK04S	1618823	116	VS-04-C-SDB/PH/0,3	1405565	439	VS-BU-LH-3,6/18/3,8	1655454	435	VS-P1220-P1226-C1021/ 5,0	1609235	353
ST-8ES1N8AH100S	1613629	123	VS-04-MS-IP67	1402489	439	VS-BU-LK-3,6/22,8/2,6	1688256	435	VS-P1220-P1226-C1021/...	1609248	353
ST-8ES1N8AW400S	1613630	117	VS-08-A-RJ45/MOD-1-IP20	1689433	362	VS-BU-LK-3,6/22,8/4,6	1688272	435	VS-P1222-P1222-C1020/ 1,0	1609251	352
ST-8ES1N8AW500S	1620461	121	VS-08-A-RJ45/MOD-1-IP67	1689080	337	VS-BU-SC-2,6	1655470	435	VS-P1222-P1222-C1020/ 2,0	1609264	352
ST-8ES1N8AWK00S	1620459	121	VS-08-A-RJ45/MOD-1-IP67-BK	1658642	337	VS-CABLE-STRIP-VARIO	1657407	324	VS-P1222-P1222-C1020/ 5,0	1609277	352
ST-8ES1N8AWQ00S	1613631	117	VS-08-A-RJ45/MOD-1-R-IP67	1689844	337	VS-CT-RJ45-H	1653265	336	VS-P1222-P1222-C1020/...	1609280	352
ST-E2015151	1613831	71	VS-08-A-RJ45/MOD-1-R-IP67 BK	1658053	337	VS-FSBPXS-OE-94F/0,5	1424135	393	VS-P1222-P1226-C1021/ 1,0	1609293	353
ST-Z0001	1607770	162	VS-08-BU-RJ45-5-F/PK	1652936	337	VS-FSBPXS-OE-94F/1,0	1424148	393	VS-P1222-P1226-C1021/ 2,0	1609303	353
ST-Z0002	1607771	162	VS-08-BU-RJ45-6-MOD/BU	1653155	337	VS-FSBPXS-OE-94F/2,0	1424151	393	VS-P1222-P1226-C1021/ 5,0	1609316	353
ST-Z0003	1607772	162	VS-08-BU-RJ45-6/KA/LSA	1653168	337	VS-FSBPXS-OE-94F/5,0	1424164	393	VS-P1222-P1226-C1021/...	1609329	353
ST-Z0004	1607773	162	VS-08-BU-RJ45-10G-F	1424009	337	VS-FSBPXS-OE-94H/0,5 SCO	1407504	395	VS-P1223-P1223-C1020/ 1,0	1609374	352
ST-Z0005	1607775	162	VS-08-BU-RJ45/BU	1689064	337	VS-FSBPXS-OE-94H/1,0 SCO	1407505	395	VS-P1223-P1223-C1020/ 2,0	1609387	352
ST-Z0006	1607776	166	VS-08-BU/BU-RJ45-F	1405617	337	VS-FSBPXS-OE-94H/2,0 SCO	1407506	395	VS-P1223-P1223-C1020/ 5,0	1609390	352
ST-Z0007	1607777	166	VS-08-KS-H/GN	1654756	360	VS-FSBPXS-OE-94H/5,0 SCO	1407507	395	VS-P1223-P1223-C1020/...	1609400	352
ST-Z0012	1613667	161	VS-08-KS-H/GY	1654743	360	VS-FSDB-IP20SDA/981/1,0 SCO	1420168	438	VS-PN-RJ45-5-Q/IP20	1658436	360
ST-Z0016	1617993	164	VS-08-KU-IP67	1689268	339	VS-FSDB-IP20SDA/981/2,0 SCO	1420171	438	VS-PNRJ45-PNRJ45R-93B-1,0	1418248	382
ST-Z0017	1618049	164	VS-08-KU-IP67-BK	1658684	339	VS-FSDB-IP20SDA/981/5,0 SCO	1420184	438	VS-PNRJ45-PNRJ45R-93B-2,0	1418277	382
ST-Z0018	1618050	164	VS-08-M12MR-10G-P SCO	1417443	324	VS-FSDBPS-IP20-93G-LI/2,0	1419146	385	VS-PNRJ45-PNRJ45R-93G-1,0	1402505	384
ST-Z0019	1620621	164	VS-08-M12MS-10G-P SCO	1417430	324	VS-FSDBPS-OE-93G-LI/1,0	1419135	385	VS-PNRJ45-PNRJ45R-93G-2,0	1402508	384
ST-Z0020	1620622	164	VS-08-RJ45-10G/C	1418853	336	VS-FSDBPS-OE-93G-LI/2,0	1419136	385	VS-PP-F-RJ45-10G	1403154	363
ST-Z0021	1620623	164	VS-08-RJ45-10G/Q	1419001	360	VS-FSDBPS-OE-93G-LI/5,0	1419137	385	VS-PP-F-RJ45-CAT6	1658118	363
SZK PZ1 VDE	1206450	293	VS-08-RJ45-5-Q/IP20	1656725	360	VS-IET-DSUB-SIGNAL-HD	1658503	434	VS-PP-F-SCRJ	1658121	369
SZK PZ2 VDE	1206463	290	VS-08-RJ45-5-Q/IP20 BK	1658008	360	VS-IET-DSUB-SIGNAL-STD	1658794	434	VS-PPC-C1-PC-ROBK-L	1405293	346
SZS 0,4X2,0	1205202	292	VS-08-RJ45-5-Q/IP67	1656990	336	VS-IP20-PPN-93G-LI/2,0	1419142	384	VS-PPC-C1-RJ45-POBK-8110G	1422205	345
			VS-08-RJ45-5-Q/IP67-BK	1658493	336	VS-IP20-OE-93E-LI/1,0	1405633	388	VS-PPC-C1-RJ45-POBK-PG9-4Q5	1608126	345
			VS-08-RJ45-FOLIEN-SET	1417184	345	VS-IP20-OE-94B-LI/5,0	1407699	390	VS-PPC-C1-RJ45-POBK-PG9-8Q5	1657834	345
			VS-08-SD-F	1652606	439	VS-IP20/10G-IP20/10G-94F/1	1418866	392	VS-PPC-C1-SCRJ-POBK-PG9-A3C-C	1657863	355
			VS-08-SD-F-BK	1658066	337	VS-IP20/10G-IP20/10G-94F/5	1418879	392	VS-PPC-C1-SCRJ-POBK-PG9-A4D-C	1657850	355
			VS-08-ST-H11-RJ45	1652716	336	VS-IP67-IP20-93E-LI/2,0	1405921	388	VS-PPC-C2-MSTB-MNNA-P13-A5-SP	1608074	350
T20-M4X12	1602410	665	VS-08-ST-H21-RJ45	1652729	336	VS-IP67-IP20-94B-LI/5,0	1407932	390	VS-PPC-C2-MSTB-POBK-P13-A5-SP	1657892	356
TF-SCRJ-POF KONF SET	1405246	372	VS-08-ST-H21P-RJ45	1404388	336	VS-IP67-OE-93E-LI/2,0	1405675	388	VS-PPC-F1-SCRJ-MNNA-1R-F	1405222	345
TMT 5 R	0816430	361	VS-08-T-H-RJ45/IP67	1652732	336	VS-IP67-OE-94B-LI/5,0	1407725	390	VS-PPC-F1-RJ45-MNNA-1R-F	1405358	346
TMT 5 R GN	0816401	361	VS-08-T-H-RJ45/IP67-BK	1658671	336	VS-M12FSBP-IP20-93E-LI/2,0	1406085	389	VS-PPC-F2-MSTB-MNNA-1R-P	1404045	350
TMT 5 R RD	0816427	361	VS-09-A	1688366	432	VS-M12FSBP-IP20-94B-LI/5,0	1412082	391	VS-PPC-F1-PC-POBK	1405316	356
TSD 02 SAC	1208487	286	VS-09-A-EMV-S	1688463	432	VS-MP-PPC/CG-10G	1406247	389	VS-PPC-F1-RJ45-MNNA-1C-F	1405222	345
TSD 04 SAC	1208429	55	VS-09-A-GC-BU/BU								

Type	Order No.	Page	Type	Order No.	Page	Type	Order No.	Page
VS-PPC-F2-MSTB-MNNA-1R-SPSA5	1608249	350	VS-ST-LK-3,6/22,4/4,6	1688269	435			
VS-PPC-F2-MSTB-MNNA-1R-SPSB5	1608252	350	VS-ST-SC-2,6	1655483	435			
VS-PPC-F2-MSTB-POBK-1R-P	1608281	350	VS-TO-RO-MCBK-F1411/1411	1404281	349			
VS-PPC-F2-MSTB-POBK-1R-SPSA5	1608294	350	VS-TO-RO-MCBK-F1411/1413	1404333	349			
VS-PPC-F2-MSTB-POBK-1R-SPSB5	1608304	350	VS-TO-RO-MCBK-F1417/1413	1404346	358			
VS-PPC-F2-PC-POBK	1405329	350	VS-TO-RO-MCBK-F1417/1417	1404320	358			
VS-PPC-J-1-SCRJ-MNBK	1405206	358	VS-TO-RO-MCBK-F1418/1418	1404278	338			
VS-PPC-J-1220-1227-1020-...	1405484	351	VS-TO-RO-MCBK-F1420/1420	1404317	342			
VS-PPC-J-1220-1227-1020-0,2	1404799	351	VS-TO-RO-MCBK-F1421/1421	1404294	328			
VS-PPC-J-1226-1227-1021-...	1405497	351	VS-TO-RO-MCBK-F1422/1422	1404304	328			
VS-PPC-J-1226-1227-1021-0,2	1404812	351	VS-V1-C-LC-MNNA-PG9-A1-G	1419190	333			
VS-PPC-J-4X-1227	1405387	351	VS-V1-C-LC-MNNA-PG9-B1-G	1419191	333			
VS-PPC-J-M	1405390	351	VS-V1-C-PC-POBK	1419183	330			
VS-PPC/ME-IP20-93B-LI/5,0	1416138	382	VS-V1-C-RJ45-MNNA-PG9-8-I-5-S	1419182	330			
VS-PPC/ME-IP20-93E-LI/5,0	1405992	388	VS-V1-C-SCRJ-MNNA-PG9-A1-G	1419187	333			
VS-PPC/ME-IP20-94B-LI/5,0	1407990	390	VS-V1-C-SCRJ-MNNA-PG9-A4A-G	1419189	332			
VS-PPC/ME-OE-93E-LI/5,0	1405743	388	VS-V1-C-SCRJ-MNNA-PG9-B1-G	1419188	333			
VS-PPC/ME-OE-94B-LI/5,0	1407783	390	VS-V1-F-LC-MNNA-PG9-C-S-A1	1420210	333			
VS-PPC/PL-IP20-93B-LI/5,0	1416141	383	VS-V1-F-LC-MNNA-PG9-C-S-B1	1420223	333			
VS-PPC/PL-IP20-93E-LI/5,0	1406030	389	VS-V1-F-PC-POBK	1419186	331			
VS-PPC/PL-IP20-94B-LI/5,0	1412024	391	VS-V1-F-RJ45-MNNA-1-C-S-JI-S	1419185	331			
VS-PPC/PL-OE-93E-LI/5,0	1405772	389	VS-V1-F-RJ45-MNNA-1-C-S-JJ-S	1419184	331			
VS-PPC/PL-OE-94B-LI/5,0	1407819	391	VS-V1-F-SCRJ-MNNA-PG9-C-S-A1	1420197	332			
VS-RJ45-RJ45-94P-0,3	1417993	374	VS-V1-F-SCRJ-MNNA-PG9-C-S-B1	1420207	333			
VS-RJ45-RJ45-94P-0,5	1418028	374						
VS-RJ45-RJ45-94P-1,0	1418057	374						
VS-RJ45-RJ45-94P-2,0	1418109	374						
VS-RJ45-RJ45-94P-5,0	1418141	374						
VS-RJ45-RJ45R-94P-0,3	1418002	374						
VS-RJ45-RJ45R-94P-0,5	1418031	374						
VS-RJ45-RJ45R-94P-1,0	1418070	374						
VS-RJ45-RJ45R-94P-2,0	1418125	374						
VS-RJ45-RJ45R-94P-5,0	1418154	374						
VS-RJ45R-RJ45R-94P-0,3	1418015	374						
VS-RJ45R-RJ45R-94P-0,5	1418044	374						
VS-RJ45R-RJ45R-94P-1,0	1418099	374						
VS-RJ45R-RJ45R-94P-2,0	1418138	374						
VS-RJ45R-RJ45R-94P-5,0	1418167	374						
VS-SCRJ-A-TC-IP67	1658545	341						
VS-SCRJ-GOF-BU/BU	1652978	341						
VS-SCRJ-GOF-FA-IP67	1657083	341						
VS-SCRJ-GOF-KU	1654358	368						
VS-SCRJ-HCS-FA-IP20	1654866	364						
VS-SCRJ-HCS-FA-IP20-PN	1404087	365						
VS-SCRJ-HCS-FA-IP67	1657012	341						
VS-SCRJ-PC	1653757	340						
VS-SCRJ-POF-FA-IP20	1654879	364						
VS-SCRJ-POF-FA-IP67	1657009	340						
VS-SCRJ-POF-KONFTOOL-POLISH	1658820	372						
VS-SCRJ-POF-POLISH	1656673	372						
VS-SI-BZ	1656660	704						
VS-SI-EB-EMV-1	1656482	704						
VS-SI-EB-EMV-2	1656495	704						
VS-SI-FP-2DSUB15	1656592	705						
VS-SI-FP-2DSUB15-GC-BU/ST	1657737	705						
VS-SI-FP-2DSUB25	1656615	705						
VS-SI-FP-2DSUB25-GC-BU/ST	1657753	705						
VS-SI-FP-2DSUB9	1656563	705						
VS-SI-FP-2DSUB9-GC-BU/ST	1657708	705						
VS-SI-FP-2F	1658532	708						
VS-SI-FP-2RJ-MOD	1656631	705						
VS-SI-FP-2RJ45-5-MOD-BU/BU	1657766	705						
VS-SI-FP-BP	1656657	704						
VS-SI-FP-DSUB15-DSUB25	1656602	705						
VS-SI-FP-DSUB15DSUB25-GC-BU/ST	1657740	705						
VS-SI-FP-DSUB9-DSUB15	1656576	705						
VS-SI-FP-DSUB9-DSUB15-GC-BU/ST	1657711	705						
VS-SI-FP-DSUB9-DSUB25	1656589	705						
VS-SI-FP-DSUB9-DSUB25-GC-BU/ST	1657724	705						
VS-SI-SD-DE	1656505	705						
VS-SI-SD-DE-G	1656518	705						
VS-SI-SD-FR	1656534	705						
VS-SI-SD-GB	1656547	705						
VS-SI-SD-IT	1656550	705						
VS-SI-SD-USA	1656521	705						
VS-ST-CD-1,0/14,8/0,2	1688971	434						
VS-ST-CD-1,0/14,8/0,5	1688968	434						
VS-ST-CD-HD-1,0/13,5/0,37	1655276	434						
VS-ST-LH-3,6/18/3,8	1655467	435						
VS-ST-LK-3,6/22,4/2,6	1688243	435						

W

WIREFOX-PN POF 1405249 372

Z

ZBF 8:UNBEDRUCKT 0808781 429
ZBF10 CUS 0825031 290
ZBF10:UNBEDRUCKT 0809997 290
ZBN 18 CUS 0825059 294ZBN 18 YE CUS 0825058 294
ZBN 18:UNBEDRUCKT 2809128 294

For up-to-date modifications or supplements
to the catalog contents, please visit:
phoenixcontact.net/webcode/#0132

