

SAC-3P-M12MS/ 0,6-PUR/M12FR B

Order No.: 1668409



<http://eshop.phoenixcontact.de/phoenix/treeViewClick.do?UID=1668409>

Sensor/Actuator cable, 3-position, PUR halogen-free, Black-gray RAL 7021, Plug, straightLink:M12, A-coded, on Socket, angled M12, A-coded, PIN 2+4 bridged, Cable length: 0.6 m

Commercial data	
GTIN (EAN)	 4 017918 135751
sales group	D110
Pack	1 pcs.
Customs tariff	85444290
Catalog page information	Page 122 (PC-2011)

Product notes

WEEE/RoHS-compliant since:
08/01/2005



<http://www.download.phoenixcontact.com>
Please note that the data given here has been taken from the online catalog. For comprehensive information and data, please refer to the user documentation. The General Terms and Conditions of Use apply to Internet downloads.

Technical data	
General data	
Rated current at 40°C	4 A
Rated voltage	250 V
Number of positions	3
Volume resistance	≤ 5 mΩ

Insulation resistance	≥ 100 MΩ
Length of cable	0.6 m
Ambient temperature (operation)	-25 °C ... 90 °C (Male connector / female connector)

General characteristics

Standards/regulations	M12 connector IEC 61076-2-101
Coding	A - standard
Surge voltage category	II
Pollution degree	3
Degree of protection	IP65/IP68/IP69K
Insertion/withdrawal cycles	≥ 100
Torque	0.4 Nm (M12 connector)
Contact material	CuSn
Contact surface material	Ni/Au
Contact carrier material	TPU GF
Material of grip body	TPU, hardly inflammable, self-extinguishing
Material, knurls	Zinc die-cast, nickel-plated
Sealing material	NBR
Status display	No

Conductor data

Cable type	PUR halogen-free black
Cable type (abbreviation)	PUR
Cable abbreviation	Li9Y11Y
UL AWM Style	20549
Conductor cross section	0.34 mm ²
AWG signal line	22
Conductor structure signal line	42x 0.10 mm
Core diameter including insulation	1.27 mm ±0.02 mm
Thickness, insulation	≥ 0.21 mm (Core insulation) Approx. 0.8 mm (Outer cable sheath)
External cable diameter	4.4 mm ±0.15 mm
Wire colors	Brown, blue, black
External sheath, color	Black-gray RAL 7021
Insulation resistance	≥ 100 GΩ*km (at 20°C)
Conductor resistance	max. 58 Ω/km (at 20°C)

Nominal voltage, conductor	≤ 300 V
Test voltage, conductor	≥ 3000 V
Overall twist	3 wires, twisted
Outer sheath, material	PUR
Material conductor insulation	PP
Conductor material	Bare Cu litz wires
Cable weight	26 kg/km
Smallest bending radius, fixed installation	22 mm
Smallest bending radius, movable installation	44 mm
Number of bending cycles	4000000
Bending radius	44 mm
Traversing path	10 m
Traversing rate	3 m/s
Acceleration	10 m/s ²
Ambient temperature (operation)	-40 °C ... 80 °C (cable, fixed installation) -5 °C ... 80 °C (cable, flexible installation)
Special properties	Flexible cable conduit capable Silicone-free Free of substances which would hinder coating with paint or varnish
Flame resistance	in accordance with DIN UL-Style 20549
Halogen-free	in accordance with DIN VDE 0472 part 815
Resistance to oil	in accordance with DIN EN 60811-2-1
Other resistance	Highly resistant to acids, alkaline solutions and solvents hydrolysis and microbe resistant

Certificates / Approvals



Certification

CUL Listed, GOST, UL Listed

Diagrams/Drawings

Dimensioned drawing

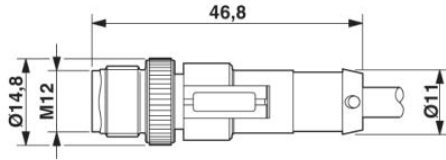

M12 x 1 male connector, straight

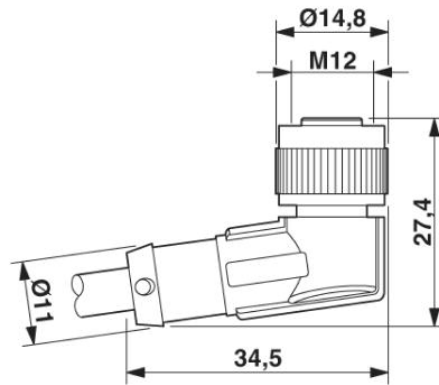

M12 x 1 female connector, angled

Circuit diagram

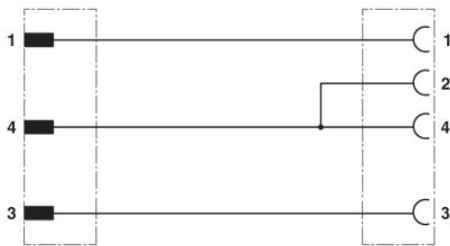

Contact assignment of M12 connectors / sockets bridged

Schematic diagram

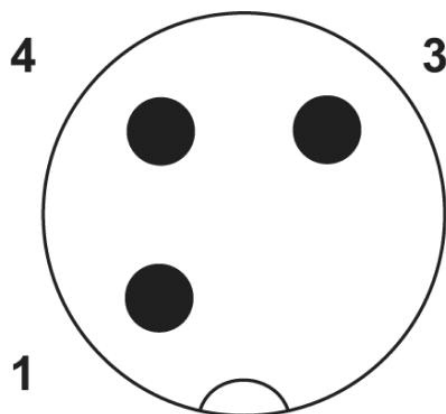

Pin assignment M12 plug, 3-pos., A-coded, view male side

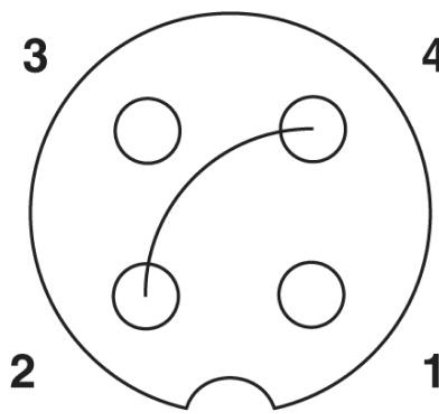

Pin assignment M12 socket, 3-pos., PIN 2+4 bridged, A-coded, view female side

Pin assignment M12, 3-pos.

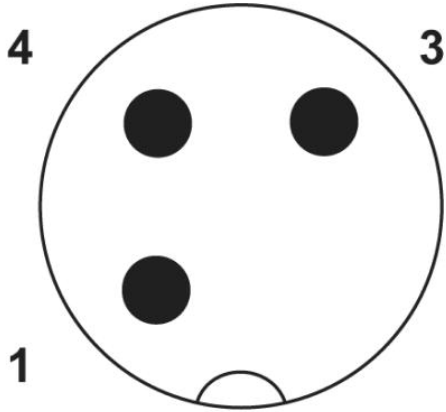

Address

PHOENIX CONTACT Inc., USA
586 Fulling Mill Road
Middletown, PA 17057, USA
Phone (800) 888-7388
Fax (717) 944-1625
<http://www.phoenixcon.com>



© 2011 Phoenix Contact
Technical modifications reserved;