

SAC-4P-M 8MR/0,3-PUR/M 8FR

Order No.: 1682265

<http://eshop.phoenixcontact.de/phoenix/treeViewClick.do?UID=1682265>

Sensor/Actuator cable, 4-position, PUR halogen-free, Black-gray RAL 7021, Plug, angledLink:M8, on Socket, angled M8, Cable length: 0.3 m

Commercial data

GTIN (EAN)	 4 017918 158927
Note	Made-to-order
sales group	D131
Pack	1 pcs.
Customs tariff	85444290
Catalog page information	Page 128 (PC-2011)

Product notesWEEE/RoHS-compliant since:
08/01/2005

<http://www.download.phoenixcontact.com>
Please note that the data given here has been taken from the online catalog. For comprehensive information and data, please refer to the user documentation. The General Terms and Conditions of Use apply to Internet downloads.

Technical data**General data**

Rated current at 40°C	4 A
Rated voltage	30 V
Number of positions	4
Volume resistance	≤ 5 mΩ
Insulation resistance	≥ 100 MΩ

Length of cable	0.3 m
Ambient temperature (operation)	-25 °C ... 90 °C (Male connector / female connector)

General characteristics

Standards/regulations	M8 connector IEC 61076-2-104
Coding	A - standard
Surge voltage category	II
Pollution degree	3
Degree of protection	IP65/IP68/IP69K
Torque	0.2 Nm (M8 plug-in connectors)
Contact material	CuSn
Contact surface material	Ni/Au
Contact carrier material	TPU GF
Material of grip body	TPU, hardly inflammable, self-extinguishing
Material, knurls	Zinc die-cast, nickel-plated
Sealing material	NBR
Status display	No

Conductor data

Cable type	PUR halogen-free black
Cable type (abbreviation)	PUR
Cable abbreviation	Li9Y11Y-HF
Conductor cross section	0.25 mm ²
AWG signal line	24
Conductor structure signal line	32 x 0.10 mm
Core diameter including insulation	1.17 mm ±0.02 mm
Thickness, insulation	≥ 0.21 mm (Core insulation)
	Approx. 0.7 mm (Outer cable sheath)
External cable diameter	4.4 mm ±0.15 mm
Wire colors	Brown, white, blue, black
External sheath, color	RAL 9005 (black gray)
Insulation resistance	≥ 100 GΩ*km (at 20°C)
Conductor resistance	max. 78 Ω/km (at 20°C)
Nominal voltage, conductor	≤ 300 V
Test voltage, conductor	≥ 3000 V
Overall twist	4 wires, twisted

Outer sheath, material	PUR
Material conductor insulation	PP
Conductor material	Bare Cu litz wires
Cable weight	25 kg/km
Smallest bending radius, fixed installation	22 mm
Smallest bending radius, movable installation	44 mm
Number of bending cycles	4000000
Bending radius	44 mm
Traversing path	10 m
Traversing rate	3 m/s
Acceleration	5 m/s ²
Ambient temperature (operation)	-40 °C ... 80 °C (cable, fixed installation) -25 °C ... 80 °C (cable, flexible installation)
Special properties	Flexible cable conduit capable Silicone-free Free of substances which would hinder coating with paint or varnish
Flame resistance	in accordance with DIN UL-Style 20549
Halogen-free	in accordance with DIN VDE 0472 part 815
Resistance to oil	in accordance with DIN EN 60811-2-1
Other resistance	Highly resistant to acids, alkaline solutions and solvents hydrolysis and microbe resistant

Certificates / Approvals



Certification

CUL Listed, UL Listed

Diagrams/Drawings

Dimensioned drawing

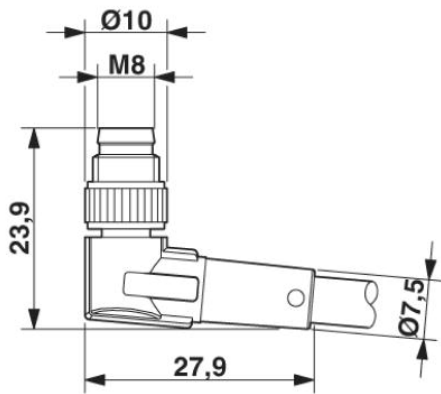

M8 x 1 male connector, angled version

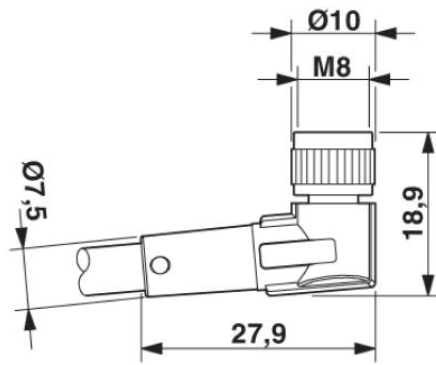

Socket M8 x 1, angled

Circuit diagram

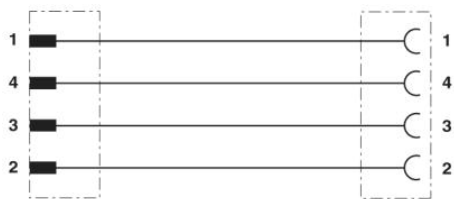

Contact assignment of M8 plugs/sockets

Schematic diagram

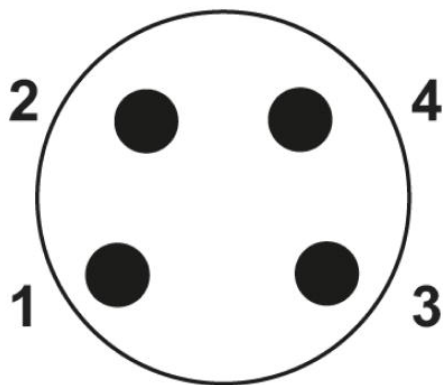

Pin assignment M8 plug, 4-pos., view male side

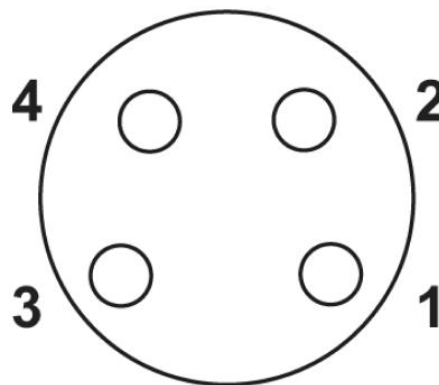

Pin assignment M8 socket, 4-pos., view female side

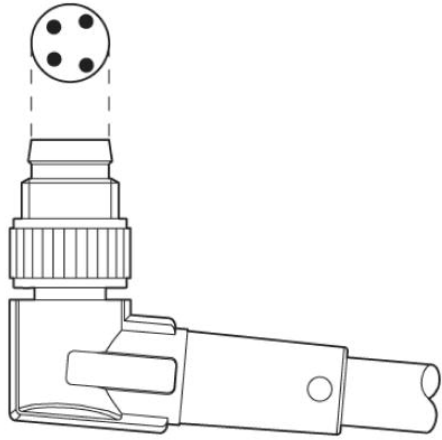

Layout of connector pin assignments

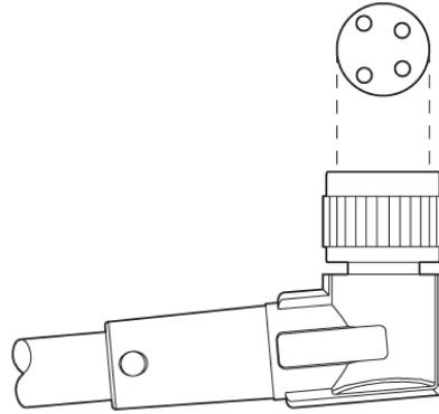

Layout of connector pin assignments

Address

PHOENIX CONTACT Inc., USA
586 Fulling Mill Road
Middletown, PA 17057, USA
Phone (800) 888-7388
Fax (717) 944-1625
<http://www.phoenixcon.com>



© 2011 Phoenix Contact
Technical modifications reserved;