

IDC 0,3/ 6-3,81

Order No.: 1706219

The figure shows a 10-position version of the product

<http://eshop.phoenixcontact.de/phoenix/treeViewClick.do?UID=1706219>

PC terminal block, Nominal current: 5 A, Nom. voltage: 160 V, Pitch: 3.81 mm, Number of positions: 6, Connection method: Insulation displacement connection QUICKON, Mounting: Soldering, Conductor/PCB connection direction: 0 °, Color: green

Commercial data

GTIN (EAN)	 4 017918 116712
Note	Made-to-order
sales group	E071
Pack	50 pcs.
Customs tariff	85369010
Catalog page information	Page 146 (CC-2011)

Product notes

WEEE/RoHS-compliant since:
01/01/2003

<http://www.download.phoenixcontact.com>
Please note that the data given here has been taken from the online catalog. For comprehensive information and data, please refer to the user documentation. The General Terms and Conditions of Use apply to Internet downloads.

Technical data

Dimensions / positions

Length	10 mm
Pitch	3.81 mm
Dimension a	19.05 mm

Number of positions	6
Pin dimensions	1 x 0,4 mm
Hole diameter	1.3 mm

Technical data

Range of articles	IDC 0,3
Insulating material group	I
Rated surge voltage (III/3)	2.5 kV
Rated surge voltage (III/2)	2.5 kV
Rated surge voltage (II/2)	2.5 kV
Rated voltage (III/3)	160 V
Rated voltage (III/2)	160 V
Rated voltage (II/2)	320 V
Connection in acc. with standard	EN-VDE
Nominal current I_N	5 A
Nominal cross section	0.34 mm ²
Maximum load current	5 A (with 0.34 mm ² conductor cross section)
Insulating material	PA
Inflammability class acc. to UL 94	V0
Nominal voltage, UL/CUL Use Group B	250 V
Nominal current, UL/CUL Use Group B	5 A
Nominal voltage, UL/CUL Use Group D	300 V
Nominal current, UL/CUL Use Group D	5 A

Connection data

Conductor cross section solid min.	0.13 mm ²
Conductor cross section solid max.	0.34 mm ²
Conductor cross section stranded min.	0.22 mm ²
Conductor cross section stranded max.	0.34 mm ²
Conductor cross section AWG/kcmil min.	26
Conductor cross section AWG/kcmil max	22
Minimum AWG according to UL/CUL	28
Maximum AWG according to UL/CUL	22

Certificates / Approvals



Certification

CSA, CUL, GOST, UL

Accessories

Item Designation Description

Marking

0804109	SK 3,81/2,8:FORTL.ZAHLEN	Marker card, printed horizontally, self-adhesive, 10-section marker strip, 14 identical decades marked 1-10, 11-20 etc. up to 91-(99)100, sufficient for 140 terminal blocks
---------	--------------------------	--

Diagrams/Drawings

Drilling plan/solder pad geometry

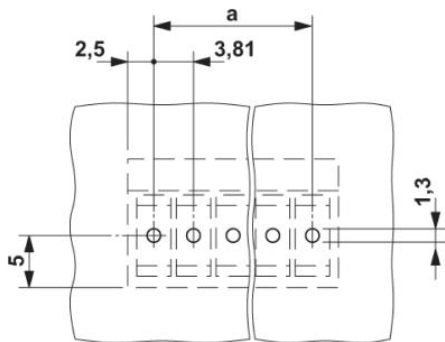

Diagram

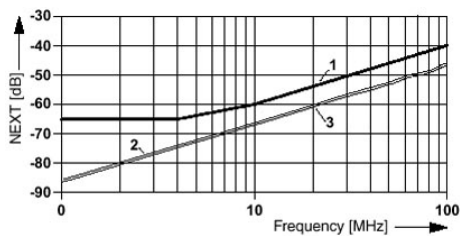

- 1 = Limit values acc. to EN 50173 for connection technology
- 2 = NEXT 12-36 on the soldering tag
- 3 = NEXT 12-36 on the contact terminal block

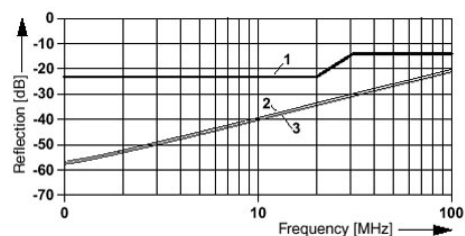

- 1 = Limit values acc. to EN 50173 for connection technology
- 2 = NEXT 12 on the soldering tag
- 3 = NEXT 36 on the soldering tag

Dimensioned drawing

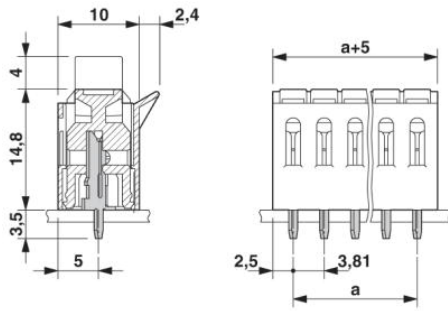

Address

PHOENIX CONTACT Inc., USA
586 Fulling Mill Road
Middletown, PA 17057, USA
Phone (800) 888-7388
Fax (717) 944-1625
<http://www.phoenixcon.com>



© 2011 Phoenix Contact
Technical modifications reserved;