

PST 1,3/ 5-5,0 R56

Order No.: 1720327



<http://eshop.phoenixcontact.de/phoenix/treeViewClick.do?UID=1720327>

Header, Nominal current: 12 A, Rated voltage (III/2): 320 V, Number of positions: 5, Pitch: 5 mm, Color: Black, Assembly: Taped SMD/THT/THR components, Voltage and current depend on the plug-in terminal block used.

Commercial data

GTIN (EAN)	 4 046356 115933
Note	Made-to-order
sales group	E432
Pack	250 pcs.
Customs tariff	85366990
Catalog page information	Page 539 (CC-2011)

Product notes

WEEE/RoHS-compliant since:
12/14/2005



<http://www.download.phoenixcontact.com>
Please note that the data given here has been taken from the online catalog. For comprehensive information and data, please refer to the user documentation. The General Terms and Conditions of Use apply to Internet downloads.

Technical data

Dimensions / positions

Length	2.8 mm
Pitch	5 mm
Dimension a	20 mm

Number of positions	5
Pin dimensions	1,3 mm
Hole diameter	1.6 mm

Technical data

Range of articles	PST 1,3/..-V
Insulating material group	IIIa
Rated surge voltage (III/3)	4 kV
Rated surge voltage (III/2)	4 kV
Rated surge voltage (II/2)	4 kV
Rated voltage (III/2)	320 V
Rated voltage (II/2)	400 V
Connection in acc. with standard	EN-VDE
Nominal current I_N	12 A (depends on the plug used)
Nominal voltage U_N	250 V
Maximum load current	12 A (depends on the plug used)
Insulating material	PA
Inflammability class acc. to UL 94	V0
Color	Black
Nominal voltage, UL/CUL Use Group B	300 V
Nominal current, UL/CUL Use Group B	16 A
Nominal voltage, UL/CUL Use Group D	300 V
Nominal current, UL/CUL Use Group D	10 A

Certificates / Approvals

Certification

CCA, CSA, CUL, GOST, SEV, UL

Diagrams/Drawings

Drilling plan/solder pad geometry

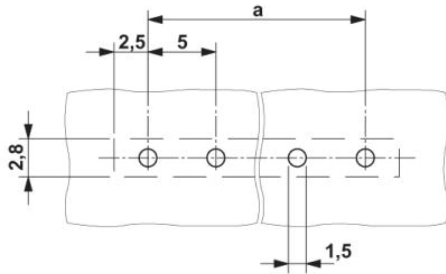

Dimensioned drawing

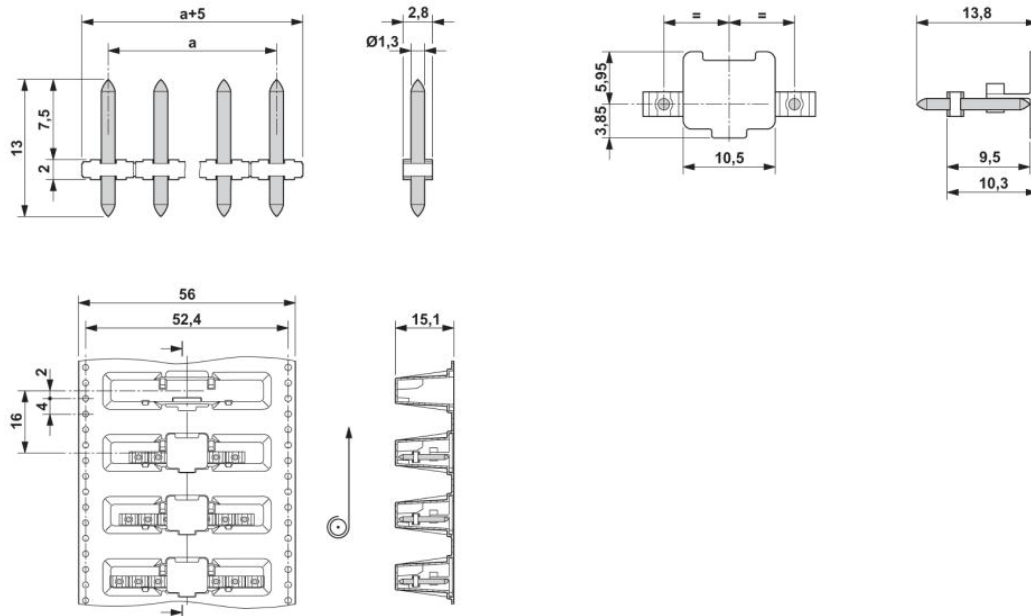

Address

PHOENIX CONTACT Inc., USA
586 Fulling Mill Road
Middletown, PA 17057, USA
Phone (800) 888-7388
Fax (717) 944-1625
<http://www.phoenixcon.com>



© 2011 Phoenix Contact
Technical modifications reserved;