

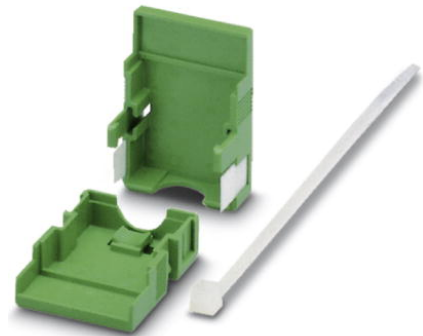

KGG-MC 1,5/ 5

Order No.: 1834372



<http://eshop.phoenixcontact.de/phoenix/treeViewClick.do?UID=1834372>

Cable housing, Pitch: 0 mm, Number of positions: 5, Dimension a: 21.44 mm, Color: green

Commercial data	
GTIN (EAN)	 4 017918 051891
sales group	E191
Pack	10 pcs.
Customs tariff	85472000
Catalog page information	Page 228 (CC-2011)

Product notes

WEEE/RoHS-compliant since:
01/01/2003



<http://www.download.phoenixcontact.com>
Please note that the data given here has been taken from the online catalog. For comprehensive information and data, please refer to the user documentation. The General Terms and Conditions of Use apply to Internet downloads.

Accessories

Item	Designation	Description
Marking		
1007248	SBS10:UNBEDRUCKT	Marker cards, unprinted, for individual labeling with the M-PEN, 250-section, perforated, white plastic

Diagrams/Drawings

Dimensioned drawing

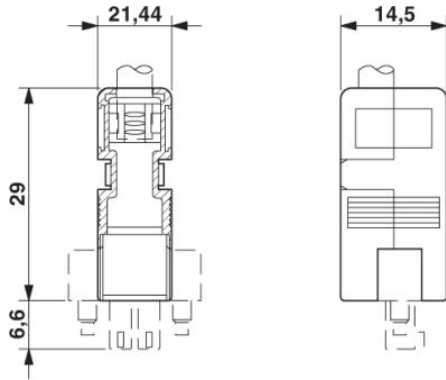

Address

PHOENIX CONTACT Inc., USA
586 Fulling Mill Road
Middletown, PA 17057, USA
Phone (800) 888-7388
Fax (717) 944-1625
<http://www.phoenixcon.com>



© 2011 Phoenix Contact
Technical modifications reserved;