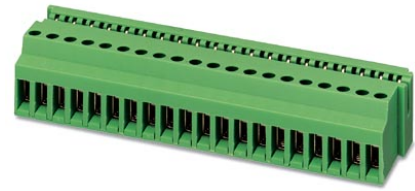

SKBD 18/MT

Order No.: 2202628

The illustration shows a 20-position version

<http://eshop.phoenixcontact.de/phoenix/treeViewClick.do?UID=2202628>

Plug-in card block, Nominal current: 5 A, Number of positions: 18,
Pitch: 5 mm, Connection method: Screw connection, Color: Green

Commercial data

GTIN (EAN)	 4 017918 053369
Note	Made-to-order
sales group	E200
Pack	10 pcs.
Customs tariff	85369010
Catalog page information	Page 263 (CC-2002)

Product notes

WEEE/RoHS-compliant since:
01/01/2003



<http://www.download.phoenixcontact.com>
Please note that the data given here has been taken from the online catalog. For comprehensive information and data, please refer to the user documentation. The General Terms and Conditions of Use apply to Internet downloads.

Technical data

Dimensions / positions

Length	23.6 mm
Height	18.4 mm
Pitch	5 mm
Number of positions	18
Screw thread	M3
Tightening torque, min	0.5 Nm
Tightening torque max	0.6 Nm

Technical data

Range of articles	SKBD
Connection in acc. with standard	EN-VDE
Nominal current I_N	5 A (applies to gold-plated contacts of the PCB)
Nominal voltage U_N	400 V
Nominal cross section	2.5 mm ²
Stripping length	8 mm

Connection data

Conductor cross section solid min.	0.2 mm ²
Conductor cross section solid max.	2.5 mm ²
Conductor cross section stranded min.	0.2 mm ²
Conductor cross section stranded max.	1.5 mm ²
Conductor cross section AWG/kcmil min.	24
Conductor cross section AWG/kcmil max	14

Certificates / Approvals

Certification

GOST, UL

Diagrams/Drawings

Dimensioned drawing

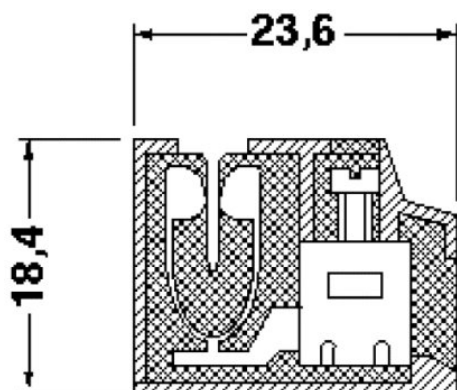

Address

PHOENIX CONTACT Inc., USA
586 Fulling Mill Road
Middletown, PA 17057, USA
Phone (800) 888-7388
Fax (717) 944-1625
<http://www.phoenixcon.com>



© 2011 Phoenix Contact
Technical modifications reserved;