

PACT MCR-V1-21-44- 75-5A-1

Order No.: 2277611



<http://eshop.phoenixcontact.de/phoenix/treeViewClick.do?UID=2277611>

Bus-bar current transformer, 75 A AC primary current; 5 A AC secondary current; accuracy class 1; 2.5 VA rated power

Commercial data	
GTIN (EAN)	 4 046356 460293
sales group	H534
Pack	1 pcs.
Customs tariff	85043129
Catalog page information	Page 697 (IF-2011)

Product notes

WEEE/RoHS-compliant since: 10/10/2008



<http://www.download.phoenixcontact.com>
 Please note that the data given here has been taken from the online catalog. For comprehensive information and data, please refer to the user documentation. The General Terms and Conditions of Use apply to Internet downloads.

Technical data

Input data	
Thermal rated short-time current	$I_{th} = 60 * I_n$
Rated surge current	$I_{dyn} = 2.5 * I_{th}$
Rated frequency: Standard converter	50 Hz ... 60 Hz
Surge current limitation factor	FS 5

Rated power	2.5 VA
Primary rated current I_{pn}	0 A ... 75 A
Secondary rated current I_{sn}	5 A AC

General data

Converter type	Tube rod converter
Class	1
Can be calibrated	No
Primary round conductor (diameter)	21 mm
Width	30 mm
Height	66 mm
Depth	44 mm
Width with alternative assembly	44 mm
Height with alternative assembly	66 mm
	30 mm
Ambient temperature (operation)	-25 °C ... 40 °C
Ambient temperature (storage/transport)	-25 °C ... 40 °C
Rated insulation voltage	1 kV
Test voltage input/output	3 kV (50 Hz, 1 min.)
Standards/regulations	IEC 60044-1
Color	black
Housing material	Polyamide PA glass fiber reinforced

Diagrams/Drawings

Dimensioned drawing

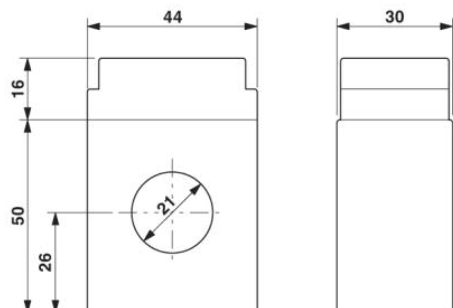

Address

PHOENIX CONTACT Inc., USA
586 Fulling Mill Road
Middletown, PA 17057, USA
Phone (800) 888-7388
Fax (717) 944-1625
<http://www.phoenixcon.com>



© 2011 Phoenix Contact
Technical modifications reserved;