

VIP-CAB-FLK14/0,14/1,5M

Order No.: 2318402



<http://eshop.phoenixcontact.de/phoenix/treeViewClick.do?UID=2318402>

Assembled round cable with two molded 14-pos. socket strips (1:1 connection). The cable has a 90° punched on connector and a 180° punched on connector, cable length: 1.5 m

Commercial data	
GTIN (EAN)	4  046356 311861
sales group	I580
Pack	1 pcs.
Customs tariff	85444290
Catalog page information	Page 278 (IF-2011)

Product notes

WEEE/RoHS-compliant since:
09/17/2007



<http://www.download.phoenixcontact.com>
Please note that the data given here has been taken from the online catalog. For comprehensive information and data, please refer to the user documentation. The General Terms and Conditions of Use apply to Internet downloads.

Technical data	
General	
Nominal voltage U_N	< 50 V AC
	60 V DC
Max. current carrying capacity per path	1 A
Max. conductor resistance	0.16 Ω /m

Ambient temperature (operation)	-20 °C ... 50 °C
Ambient temperature (storage/transport)	-20 °C ... 70 °C
Connector	Flat-ribbon cable strip (IEC 60603-1)
Number of positions	14
Number of positions, control side	14
Number of connectors, control side	1
Number of positions, module side	14
Number of connectors, modul side	1
Fixed cable length	1.5 m
Single wire, cross section	0.14 mm ²
AWG	26
Conductor construction: Number of litz wires:	7
Single wire, material	Cu tin-plated
External diameter	6.4 mm
Cable, preassembly	Insulation displacement, IEC 60352-4/DIN EN 60352-4
Shielding	no

Certificates / Approvals



Certification

CUL, UL

Diagrams/Drawings

Dimensioned drawing

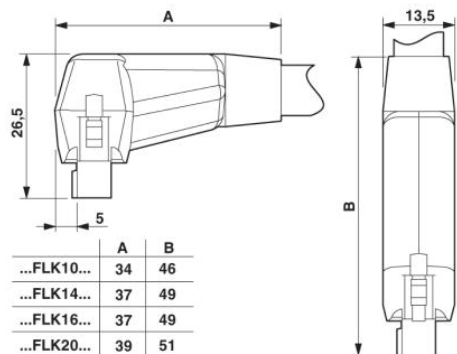

Address

PHOENIX CONTACT Inc., USA
586 Fulling Mill Road
Middletown, PA 17057, USA
Phone (800) 888-7388
Fax (717) 944-1625
<http://www.phoenixcon.com>



© 2011 Phoenix Contact
Technical modifications reserved;