

PSI-MOS-PROFIB/FO 850 E

Order No.: 2708274



<http://eshop.phoenixcontact.de/phoenix/treeViewClick.do?UID=2708274>

FO converter with integrated optical diagnosis, alarm contact, for PROFIBUS up to 12 Mbps, terminal equipment with an FO interface (BFOC), 850 nm, for fiber glass cable



Commercial data

GTIN (EAN)	 4 017918 973971
sales group	H622
Pack	1 pcs.
Customs tariff	85176200
Catalog page information	Page 501 (IF-2011)

Product notes

WEEE/RoHS-compliant since:
04/18/2007



<http://www.download.phoenixcontact.com>
Please note that the data given here has been taken from the online catalog. For comprehensive information and data, please refer to the user documentation. The General Terms and Conditions of Use apply to Internet downloads.

Technical data

Serial interface

Interface 1	PROFIBUS acc. to IEC 61158, RS-485 2-wire, half duplex, automatic control
Operating mode	Semi-duplex
File format/coding	UART (11 Bit, NRZ)

Data direction switching	Automatic control
Transmission length	max. 1200 m (depending on the data rate, with shielded, twisted pair data cable)
Connection method	D-SUB-9 female connector
Serial transmission speed	9.6/19.2/45.45/93.75/187.5/500/1500/3000/6000/12000 kbps, automatic detection, optional setting using a DIP switch

Optical interface FO

Transmit capacity, minimum	-4.2 dBm (200/230 μ m)
	-17.8 dBm (50/125 μ m)
	-14.6 dBm (62,5/125 μ m)
Minimum receiver sensitivity	-30.00 dBm (50/125 μ m)
Maximum receiver sensitivity	-3 dBm (200/230 μ m)
Wavelength	850 nm
Transmission length incl. 3 dB system reserve	800 m (With F-K 200/230 10 dB/km with quick mounting connector)
	2600 m (with F-G 50/125 2.5 dB/km)
	3300 m (with F-G 62,5/125 3.0 dB/km)
Transmission protocol	Protocol-transparent to the RS-485 interface
Connection method	B-FOC (ST [®])

Fault warning output

Maximum switching voltage	60 V DC
	42 V AC
Limiting continuous current	1 A

Power supply

Nominal supply voltage	24 V DC \pm 25%
Supply voltage range	18 V DC ... 32 V DC
Typical current consumption	100 mA (24 V DC)
Connection method	COMBICON plug-in screw terminal block

General data

Bit delay	\leq 1 Bit
Bit distortion, input	\pm 35 % (permitted)
Bit distortion, output	$<$ 6.25 %
Width	35 mm
Height	99 mm

Depth	105 mm
Ambient temperature (operation)	-20 °C ... 60 °C
Ambient temperature (storage/transport)	-40 °C ... 85 °C
Permissible humidity (operation)	30 % ... 95 % (no condensation)
Electrical isolation	(VCC // RS-485)
Test voltage data interface/power supply	1.5 kV _{rms} (50 Hz, 1 min.)
Electromagnetic compatibility	Conformance with EMC Directive 2004/108/EC
Noise emission	EN 55011
Noise immunity	EN 61000-6-2:2005
Degree of protection	IP20
Housing material	PA V0, color green
Color	green
MTBF	252 Years (Telcordia standard, 25°C temperature, 21% operating cycle (5 days a week, 8 hours a day))
	42 Years (Telcordia standard, 40°C temperature, 34.25% operating cycle (5 days a week, 12 hours a day))
ATEX	Ex II 3 G Ex nAC IIC T4 X
	Ex II (2) GD [Ex op is] IIC (PTB 06 ATEX 2042 U)
UL, USA / Canada	Class I, zone 2, AEx nc IIC

Certificates / Approvals



Certification	CUL, UL
Certification Ex:	CUL-EX LIS, PTB, UL-EX LIS

Accessories

Item	Designation	Description
Cable/conductor		
2989174	FL MM PATCH 1,0 LC-ST	Assembled fiber optic cable, break-out cable, glass fiber multi-mode 50/125 µm, connector: LC/B-FOC (ST), degree of protection: IP20, for installation in cable ducts or control cabinets, length: 1 meter

2901809	FL MM PATCH 1,0 SC-ST	Assembled FO cable, break out cable, multi-mode glass fiber 50/125 µm, connector: SC Duplex / B-FOC, protection type: IP20, for installation in cable ducts or control cabinets, length: 1 meter
2901820	FL MM PATCH 1,0 ST-SCRJ	Assembled FO cable, break out cable, multi-mode glass fiber 50/125 µm, connector: SC Duplex / SCRJ, protection type: IP20, for installation in cable ducts or control cabinets, length: 1 meter
2901815	FL MM PATCH 1,0 ST-ST	Assembled FO cable, break out cable, multi-mode glass fiber 50/125 µm, connector: B-FOC (ST) / B-FOC (ST), protection type: IP20, for installation in cable ducts or control cabinets, length: 1 meter
2989271	FL MM PATCH 2,0 LC-ST	Assembled fiber optic cable, break-out cable, glass fiber multi-mode 50/125 µm, connector: LC/B-FOC (ST), degree of protection: IP20, for installation in cable ducts or control cabinets, length: 2 meters
2901821	FL MM PATCH 2,0 ST-SCRJ	Assembled FO cable, break out cable, multi-mode glass fiber 50/125 µm, connector: B-FOC (ST) / SCRJ, protection type: IP20, for installation in cable ducts or control cabinets, length: 2 meters
2901816	FL MM PATCH 2,0 ST-ST	Assembled FO cable, break out cable, multi-mode glass fiber 50/125 µm, connector: B-FOC (ST) / B-FOC (ST), protection type: IP20, for installation in cable ducts or control cabinets, length: 2 meters
2901801	FL MM PATCH 5,0 LC-ST	Assembled FO cable, break out cable, multi-mode glass fiber 50/125 µm, plug: LC / B-FOC (ST), protection type: IP20, for installation in cable ducts or control cabinets, length: 5 meters
2901811	FL MM PATCH 5,0 SC-ST	Assembled FO cable, break out cable, multi-mode glass fiber 50/125 µm, connector: SC Duplex / B-FOC (ST), protection type: IP20, for installation in cable ducts or control cabinets, length: 5 meters
2901822	FL MM PATCH 5,0 ST-SCRJ	Assembled FO cable, break out cable, multi-mode glass fiber 50/125 µm, connector: B-FOC (ST) / SCRJ, protection type: IP20, for installation in cable ducts or control cabinets, length: 5 meters
2901817	FL MM PATCH 5,0 ST-ST	Assembled FO cable, break out cable, multi-mode glass fiber 50/125 µm, connector: B-FOC (ST) / B-FOC (ST), protection type: IP20, for installation in cable ducts or control cabinets, length: 5 meters
2989242	FL SM PATCH 1,0 LC-ST	Assembled fiber optic cable, break-out cable, glass fiber single mode 9/125 µm, connector: LC/B-FOC (ST), degree of protection: IP20, for installation in cable ducts or control cabinets, length: 1 meter
2901832	FL SM PATCH 1,0 SC-ST	Assembled FO cable, break out cable, single-mode glass fiber 9/125 µm, connector: SC Duplex / B-FOC (ST), protection type: IP20, for installation in cable ducts or control cabinets, length: 1 meter
2901836	FL SM PATCH 1,0 ST-ST	Assembled FO cable, break out cable, single-mode glass fiber 9/125 µm, connector: B-FOC (ST) / B-FOC (ST), protection type: IP20, for installation in cable ducts or control cabinets, length: 1 meter

2989349	FL SM PATCH 2,0 LC-ST	Assembled fiber optic cable, break-out cable, glass fiber single mode 9/125 µm, connector: LC/B-FOC (ST), degree of protection: IP20, for installation in cable ducts or control cabinets, length: 2 meters
2901833	FL SM PATCH 2,0 SC-ST	Assembled FO cable, break out cable, single-mode glass fiber 9/125 µm, connector: SC Duplex / B-FOC (ST), protection type: IP20, for installation in cable ducts or control cabinets, length: 2 meters
2901837	FL SM PATCH 2,0 ST-ST	Assembled FO cable, break out cable, single-mode glass fiber 9/125 µm, connector: B-FOC (ST) / B-FOC (ST), protection type: IP20, for installation in cable ducts or control cabinets, length: 2 meters
2901828	FL SM PATCH 5,0 LC-ST	Assembled FO cable, break out cable, single-mode glass fiber 9/125 µm, connector: LC / B-FOC (ST), protection type: IP20, for installation in cable ducts or control cabinets, length: 5 meters
2901834	FL SM PATCH 5,0 SC-ST	Assembled FO cable, break out cable, single-mode glass fiber 9/125 µm, connector: SC Duplex / B-FOC (ST), protection type: IP20, for installation in cable ducts or control cabinets, length: 5 meters
2901838	FL SM PATCH 5,0 ST-ST	Assembled FO cable, break out cable, single-mode glass fiber 9/125 µm, connector: B-FOC (ST) / B-FOC (ST), protection type: IP20, for installation in cable ducts or control cabinets, length: 5 meters
2744652	PSM-CABLE-PROFIB/FC	PROFIBUS cable, Fast Connect type, up to 12 Mbps (02YSY (ST)CY 1x2x22 AWG)
2799322	PSM-LWL-GDM-RUGGED-50/125	Glass fiber cable, duplex 50/125 µm, by the meter, without connector, for indoor installation
2799432	PSM-LWL-GDO- 50/125	Glass fiber cable, duplex 50/125 µm, by the meter, without connector, for outdoor installation
2799885	PSM-LWL-HCS-RUGGED-200/230	HCS cable, duplex 200/230 µm, by the meter, without connector, for indoor installation
2799445	PSM-LWL-HCSO-200/230	HCS cable, duplex 200/230 µm, by the meter, without connector, for outdoor installation
2744911	PSM-LWL/GDM-RUGGED	Glass fiber cable, duplex 50/125 µm, by the meter, with connector, for indoor installation
2744924	PSM-LWL/GDO	Glass fiber cable, duplex 50/125 µm, by the meter, with connector, for outdoor installation
2744937	PSM-LWL/HCS-RUGGED	HCS cable, duplex 200/230 µm, by the meter, with connector, for indoor installation
2744940	PSM-LWL/HCSO	HCS cable, duplex 200/230 µm, by the meter, with connector, for outdoor installation
General		
2709561	ME 17,5 TBUS 1,5/ 5-ST-3,81 GN	DIN rail connector for DIN rail power supply unit, gold-plated contacts, for DIN rail mounting, 5-pos.

2890014	ME 17,5 TBUS 1,5/PP000-3,81 BK	Plug component
2866983	MINI-SYS-PS-100-240AC/24DC/1.5	DIN rail power supply unit, primary-switched mode, slim design, output: 24 V DC / 1.5 A
2708863	PSI-REP-PROFIBUS/12MB	Modular repeater for electrical isolation and range increase for PROFIBUS up to 12 Mbps, 4-way isolation, rail-mountable, supply 24 V DC
2313944	PSI-TERMINATOR-PB	Active termination resistor with redundant voltage supply for PROFIBUS and RS-485 bus systems. Compact design. Electrical isolation between supply and data interface. Bus termination can be switched. Integrated programming interface.
2760623	PSM PTK	Passive RS-485 T-distributor, fitted with one 9-pin D-SUB pin strip and two 9-pin D-SUB socket strips
2799364	PSM PTK-4	Passive RS-485 T-distributor, fitted with one 9-pin D-SUB pin strip and five 9-pin D-SUB socket strips
2744429	PSM-ME-RS485/RS485-P	Repeater, for potential separation and range increase in RS-485 2-wire bus systems, 3-way isolation, rail-mountable

Plug/Adapter

2708481	PSM-SET-B-FOC/4-HCS	B-FOC (ST) connector set for HCS fiber, for self assembly consisting of 4 quick mounting connectors with bend protection sleeve
2799429	PSM-SET-BFOC-LINK/2	Coupling; set consisting of 2 couplings for connecting B-FOC plugs
2744380	SUBCON-PLUS-PROFIB/AX/SC	D-SUB connector, 9-pos., male connector, axial version with two cable entries, bus system: PROFIBUS DP up to 12 Mbps, termination resistor can be switched on via slide switch, pin assignment: 3, 5, 6, 8; screw connection terminal blocks
2708245	SUBCON-PLUS-PROFIB/PG/SC2	D-SUB connector, 9-pos., male connector, cable entry < 35°, bus system: PROFIBUS DP up to 12 Mbps with PG D-SUB female connector for connecting a programming device, termination resistor can be switched on via slide switch, pin assignment: 3, 5, 6, 8; screw connection terminal blocks
2708232	SUBCON-PLUS-PROFIB/SC2	D-SUB connector, 9-pos., male connector, cable entry < 35°, bus system: PROFIBUS DP up to 12 Mbps, termination resistor can be switched on via slide switch, pin assignment: 3, 5, 6, 8; screw connection terminal blocks

Tools

2799539	PSM-FO-POWERMETER	Fiber optic measuring case, consisting of an optical power meter, F-SMA, B-FOC adapters, reference fibers and operating instructions
2708465	PSM-HCS-KONFTOOL/B-FOC	HCS assembly kit for B-FOC (ST) quick mounting connectors, including stripping blade, stripping pliers, aramide yarn scissors, fiber stripper, microscope, fiber cleaving tool for standard HCS and HCS GI fibers, and documentation
2744623	PSM-STRIP-FC/PROFIB	Quick stripping tool for PROFIBUS cable, type Fast Connect

1205037	SZS 0,4X2,5 VDE	Screwdriver, bladed, VDE insulated, size: 0.4 x 2.5 x 80 mm, 2-component grip, with non-slip grip
---------	-----------------	---

Diagrams/Drawings

Application drawing

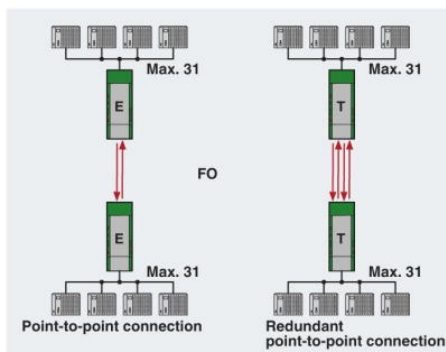
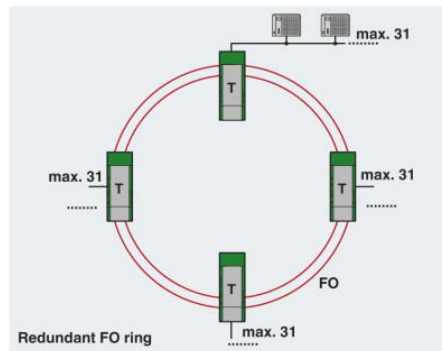
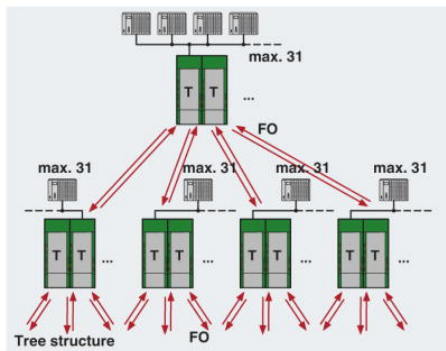
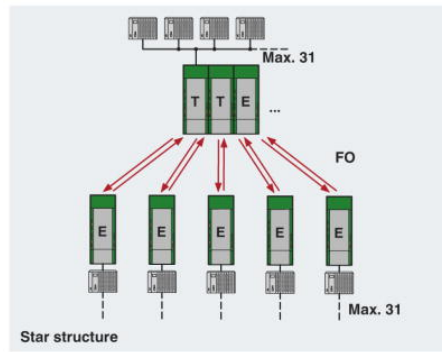
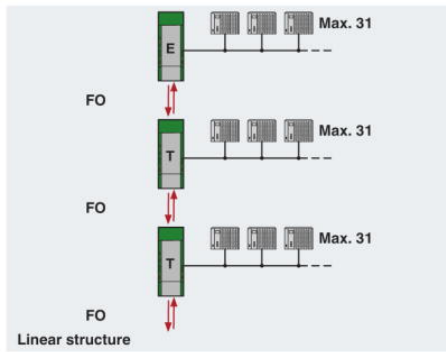

Block diagram

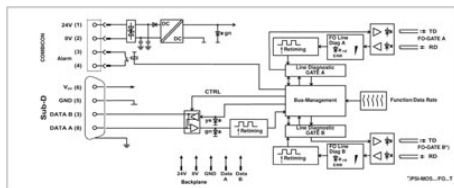

*) only with PSI-MOS.../FO...T

Address

PHOENIX CONTACT Inc., USA
586 Fulling Mill Road
Middletown, PA 17057, USA
Phone (800) 888-7388
Fax (717) 944-1625
<http://www.phoenixcon.com>



© 2011 Phoenix Contact
Technical modifications reserved;