

PSI-MOS-PROFIB/FO 660 T

Order No.: 2708287



<http://eshop.phoenixcontact.de/phoenix/treeViewClick.do?UID=2708287>

FO converter with integrated optical diagnosis, alarm contact, for PROFIBUS up to 12 Mbps, T-coupler with two FO interfaces (FSMA), 660 nm, for polymer/HCS fiber cable



Commercial data

GTIN (EAN)	 4 017918 973988
sales group	H622
Pack	1 pcs.
Customs tariff	85176200
Catalog page information	Page 501 (IF-2011)

Product notes

WEEE/RoHS-compliant since:
04/18/2007



<http://www.download.phoenixcontact.com>
Please note that the data given here has been taken from the online catalog. For comprehensive information and data, please refer to the user documentation. The General Terms and Conditions of Use apply to Internet downloads.

Technical data

Serial interface

Interface 1	PROFIBUS acc. to IEC 61158, RS-485 2-wire, half duplex, automatic control
Operating mode	Semi-duplex
File format/coding	UART (11 Bit, NRZ)

Data direction switching	Automatic control
Transmission length	max. 1200 m (depending on the data rate, with shielded, twisted pair data cable)
Connection method	D-SUB-9 female connector
Serial transmission speed	9.6/19.2/45.45/93.75/187.5/500/1500/3000/6000/12000 kbps, automatic detection, optional setting using a DIP switch

Optical interface FO

Transmit capacity, minimum	-3 dBm (980/1000 µm)
	-15.4 dBm (200/230 µm)
Minimum receiver sensitivity	-30.00 dBm
Maximum receiver sensitivity	-3 dBm (980/1000 µm)
Wavelength	660 nm
Transmission length incl. 3 dB system reserve	70 m (With F-P 980/1000 230 dB/km with quick mounting connector)
	400 m (With F-K 200/230 10 dB/km with quick mounting connector)
Transmission protocol	Protocol-transparent to the RS-485 interface
Connection method	F-SMA

Fault warning output

Maximum switching voltage	60 V DC
	42 V AC
Limiting continuous current	1 A

Power supply

Nominal supply voltage	24 V DC ± 25%
Supply voltage range	18 V DC ... 32 V DC
Typical current consumption	100 mA (24 V DC)
Connection method	COMBICON plug-in screw terminal block

General data

Bit delay	≤ 1 Bit
Bit distortion, input	± 35 % (permitted)
Bit distortion, output	< 6.25 %
Width	35 mm
Height	99 mm
Depth	105 mm
Ambient temperature (operation)	-20 °C ... 60 °C

Ambient temperature (storage/transport)	-40 °C ... 85 °C
Permissible humidity (operation)	30 % ... 95 % (no condensation)
Electrical isolation	(VCC // RS-485)
Test voltage data interface/power supply	1.5 kV _{rms} (50 Hz, 1 min.)
Electromagnetic compatibility	Conformance with EMC Directive 2004/108/EC
Noise emission	EN 55011
Noise immunity	EN 61000-6-2:2005
Degree of protection	IP20
Net weight	190 g
Housing material	PA V0, color green
Color	green
MTBF	201 Years (Telcordia standard, 25°C temperature, 21% operating cycle (5 days a week, 8 hours a day))
	42 Years (Telcordia standard, 40°C temperature, 34.25% operating cycle (5 days a week, 12 hours a day))
ATEX	Ex II 3 G Ex nAC IIC T4 X
	Ex II (2) GD [Ex op is] IIC (PTB 06 ATEX 2042 U)
UL, USA / Canada	Class I, zone 2, AEx nc IIC

Certificates / Approvals



Certification	CUL, UL
Certification Ex:	CUL-EX LIS, PTB, UL-EX LIS

Accessories

Item	Designation	Description
Cable/conductor		
2744652	PSM-CABLE-PROFIB/FC	PROFIBUS cable, Fast Connect type, up to 12 Mbps (02YSY (ST)CY 1x2x22 AWG)
2799885	PSM-LWL-HCS-RUGGED-200/230	HCS cable, duplex 200/230 µm, by the meter, without connector, for indoor installation

2799445	PSM-LWL-HCSO-200/230	HCS cable, duplex 200/230 µm, by the meter, without connector, for outdoor installation
2744319	PSM-LWL-KDHEAVY-980/1000	Polymer fiber cable, duplex 980/1000 µm, medium-weight version for permanent indoor installation, by the meter, without connector
2744322	PSM-LWL-RUGGED-980/1000	Polymer fiber cable, duplex, 980 µm/1000 µm, heavy version for permanent indoor installation, sold by the meter without connectors
2744982	PSM-LWL-RUGGED-FLEX	Polymer fiber cable, duplex 980/1000 µm, heavy-weight, highly flexible version for flexible conduit applications, by the meter, with connector
2744335	PSM-LWL-RUGGED-FLEX-980/1000	Polymer fiber cable, duplex 980/1000 µm, heavy-weight, highly flexible version for flexible conduit applications, by the meter, without connector
2744937	PSM-LWL/HCS-RUGGED	HCS cable, duplex 200/230 µm, by the meter, with connector, for indoor installation
2744940	PSM-LWL/HCSO	HCS cable, duplex 200/230 µm, by the meter, with connector, for outdoor installation
2744966	PSM-LWL/KDHEAVY	Polymer fiber cable, duplex 980/1000 µm, medium-weight version for permanent indoor installation, by the meter, with connector
2744979	PSM-LWL/RUGGED	Polymer fiber cable, duplex 980/1000 µm, heavy-weight version for permanent indoor installation, by the meter, with connector

General

2709561	ME 17,5 TBUS 1,5/ 5-ST-3,81 GN	DIN rail connector for DIN rail power supply unit, gold-plated contacts, for DIN rail mounting, 5-pos.
2890014	ME 17,5 TBUS 1,5/PP000-3,81 BK	Plug component
2866983	MINI-SYS-PS-100-240AC/24DC/1.5	DIN rail power supply unit, primary-switched mode, slim design, output: 24 V DC / 1.5 A
2708863	PSI-REP-PROFIBUS/12MB	Modular repeater for electrical isolation and range increase for PROFIBUS up to 12 Mbps, 4-way isolation, rail-mountable, supply 24 V DC
2313944	PSI-TERMINATOR-PB	Active termination resistor with redundant voltage supply for PROFIBUS and RS-485 bus systems. Compact design. Electrical isolation between supply and data interface. Bus termination can be switched. Integrated programming interface.
2760623	PSM PTK	Passive RS-485 T-distributor, fitted with one 9-pin D-SUB pin strip and two 9-pin D-SUB socket strips
2799364	PSM PTK-4	Passive RS-485 T-distributor, fitted with one 9-pin D-SUB pin strip and five 9-pin D-SUB socket strips
2744429	PSM-ME-RS485/RS485-P	Repeater, for potential separation and range increase in RS-485 2-wire bus systems, 3-way isolation, rail-mountable

Plug/Adapter

2799416	PSM-SET-FSMA-LINK/2	Coupling; set consisting of 2 couplings for connecting F-SMA plugs
2799487	PSM-SET-FSMA/4-HCS	F-SMA plug set for HCS fiber, for self assembly consisting of 4 quick mounting connectors with bend protection sleeve
2799720	PSM-SET-FSMA/4-KT	F-SMA plug set for polymer fiber, for self assembly consisting of 4 quick mounting connectors with bend protection sleeve
2744380	SUBCON-PLUS-PROFIB/AX/SC	D-SUB connector, 9-pos., male connector, axial version with two cable entries, bus system: PROFIBUS DP up to 12 Mbps, termination resistor can be switched on via slide switch, pin assignment: 3, 5, 6, 8; screw connection terminal blocks
2708245	SUBCON-PLUS-PROFIB/PG/SC2	D-SUB connector, 9-pos., male connector, cable entry < 35°, bus system: PROFIBUS DP up to 12 Mbps with PG D-SUB female connector for connecting a programming device, termination resistor can be switched on via slide switch, pin assignment: 3, 5, 6, 8; screw connection terminal blocks
2708232	SUBCON-PLUS-PROFIB/SC2	D-SUB connector, 9-pos., male connector, cable entry < 35°, bus system: PROFIBUS DP up to 12 Mbps, termination resistor can be switched on via slide switch, pin assignment: 3, 5, 6, 8; screw connection terminal blocks

Tools

2799539	PSM-FO-POWERMETER	Fiber optic measuring case, consisting of an optical power meter, F-SMA, B-FOC adapters, reference fibers and operating instructions
2799526	PSM-HCS-KONFTOOL	HCS assembly kit for F-SMA quick mounting connectors, including stripping blade, stripping pliers, aramide yarn scissors, fiber stripper, microscope, fiber cleaving tool for standard HCS fibers, and documentation
2744131	PSM-POF-KONFTOOL	Polymer fiber DIY case, consisting of: Stripping knife, stripping pliers, polishing wheels for F-SMA and SCRJ quick mounting connectors, polishing pad and emery paper
2799348	PSM-SET-FSMA-POLISH	Polymer fiber polishing set, for F-SMA quick mounting connectors
2744623	PSM-STRIP-FC/PROFIB	Quick stripping tool for PROFIBUS cable, type Fast Connect
1205037	SZS 0,4X2,5 VDE	Screwdriver, bladed, VDE insulated, size: 0.4 x 2.5 x 80 mm, 2-component grip, with non-slip grip

Diagrams/Drawings

Application drawing

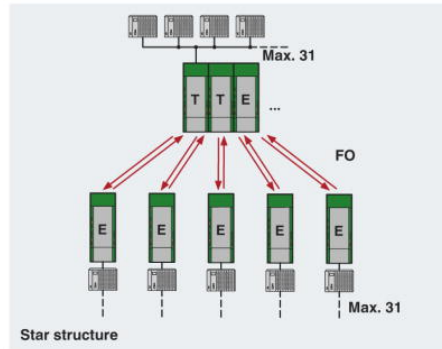
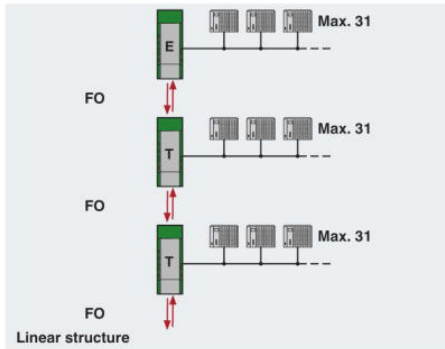

Tree structure

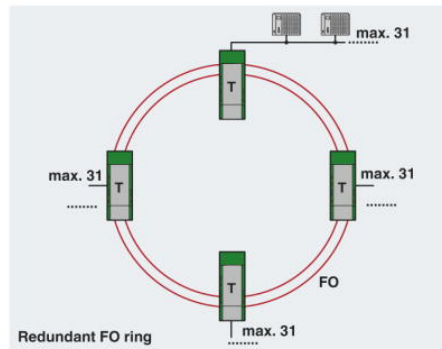
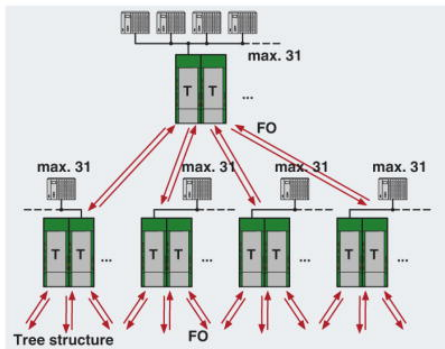

Redundant FO ring

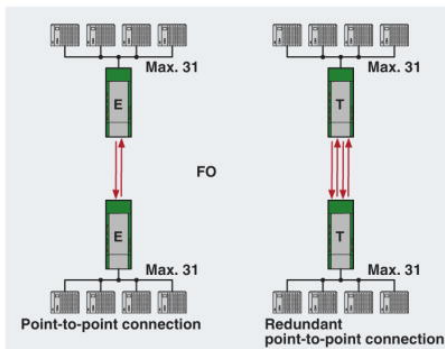

Block diagram

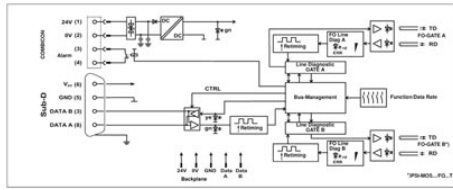

*) only with PSI-MOS.../FO...T

Address

PHOENIX CONTACT Inc., USA
586 Fulling Mill Road
Middletown, PA 17057, USA
Phone (800) 888-7388
Fax (717) 944-1625
<http://www.phoenixcon.com>



© 2011 Phoenix Contact
Technical modifications reserved;