

LDP- 48- 60DC

Order No.: 2833660

<http://eshop.phoenixcontact.de/phoenix/treeViewClick.do?UID=2833660>

Plug-in module, for mounting on PR1 and PR2, with damping diode and yellow LED, polarity: **A1+**, **A2-**, input voltage: 48 -60 V DC \pm 20%

Commercial data	
GTIN (EAN)	 4 017918 933852
sales group	G381
Pack	10 pcs.
Customs tariff	85366990
Catalog page information	Page 72 (IF-2011)

Product notes

WEEE/RoHS-compliant since:
03/01/2006



<http://www.download.phoenixcontact.com>
Please note that the data given here has been taken from the online catalog. For comprehensive information and data, please refer to the user documentation. The General Terms and Conditions of Use apply to Internet downloads.

Diagrams/Drawings

Circuit diagram

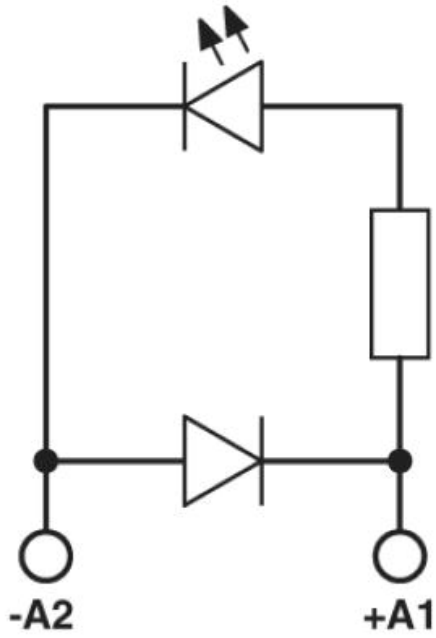

Address

PHOENIX CONTACT Inc., USA
586 Fulling Mill Road
Middletown, PA 17057, USA
Phone (800) 888-7388
Fax (717) 944-1625
<http://www.phoenixcon.com>



© 2011 Phoenix Contact
Technical modifications reserved;